

+Redamed

NEUROCHIRURGIE
NEUROSURGERY
NEUROCIRUGIA
NEUROCHIRURGIA





Maltepe Mah.Eski ırpıcıyolu Sk.
Merter İş Merkezi D Blok 2/21
034234- Zeytinburnu, İstanbul

+90 212 482 71 52
info@redamed.com

Charrière (Ch) French (F)	Durchmesser in mm	Inches
1	0,33	0,013
2	0,67	0,025
3	1,00	0,039
4	1,33	0,051
5	1,67	0,065
6	2,00	0,0787
7	2,33	0,092
8	2,67	0,105
9	3,00	0,1181
10	3,33	0,131
11	3,67	0,144
12	4,00	0,1575
13	4,33	0,170
14	4,67	0,184
15	5,00	0,1968
16	5,33	0,210
17	5,67	0,223
18	6,00	0,2362
19	6,33	0,249
20	6,67	0,263
21	7,00	0,2756
22	7,33	0,288
23	7,67	0,302
24	8,00	0,3150
25	8,33	0,328
26	8,67	0,341
27	9,00	0,3543
28	9,33	0,367
29	9,67	0,380
30	10,00	0,3973
31	10,33	0,407
32	10,67	0,420
34	11,33	0,446
36	12,00	0,4724
38	12,67	0,494
40	13,33	0,5199
45	15,00	0,5905

Gauge (G)	Durchmesser in mm	Inches
35	0,13	0,005
34	0,18	0,007
33	0,20	0,008
32	0,23	0,009
31	0,25	0,010
30	0,30	0,012
29	0,33	0,013
28	0,36	0,014
27	0,41	0,016
26	0,46	0,018
25	0,51	0,020
	0,53	0,021
24	0,56	0,022
23	0,64	0,025
22	0,71	0,028
21	0,81	0,032
20	0,89	0,035
	0,97	0,038
19	1,07	0,042
18	1,27	0,050
17	1,50	0,059
16	1,65	0,065
15	1,83	0,072
14	2,11	0,083
13	2,41	0,095
12	2,77	0,109
11	3,05	0,120
10	3,40	0,134
9	3,76	0,148
8	4,19	0,165
7	4,57	0,180
6	5,16	0,203

1 OZ	0,028 ml
5 OZ	0,140 ml
16 OZ	0,450 ml

35 OZ	1,0 l
128 OZ	3,7 l

GARANTIE / WARRANTY / GARANTIA / GARANZIA

GARANTIE

Wir gewähren auf alle **Reda**-Instrumente 5 Jahre Garantie. Voraussetzung ist der sach- und fachgerechte Einsatz der Instrumente. Von der Garantie sind Verschleißerscheinungen ausgeschlossen.

WARRANTY

Our **Reda** products are free from manufacturing defects in material and workmanship. We therefore give on all instruments a guarantee of five years provided that the instruments are maintained and cleaned properly and used normally for their intended purpose.

GARANTIA

Estamos convencidos de nuestra calidad y concedemos a todos los instrumentos de **Reda** 5 años de garantía contra cualquier defecto de fabricación, siempre y cuando se usen adecuadamente. De la garantía excluimos la manifestación de desgaste.

GARANZIA

Siamo convinti della nostra qualità e concediamo cinque anni di garanzia sulla funzione dei tutti gli strumenti **Reda** sotto la presupposizione che l'utilizzo è da esperto. Escluso della garanzia sono tracce di consumo.

Arbeitsanweisung Aufbereitung (Reinigung) und Sterilisation von resterilisierbaren chirurgischen Instrumenten

DIN EN ISO 17664:2018

Hersteller:
REDA Instrumente GmbH, Gänsäcker 34
78532 Tuttlingen

Alle von Reda gelieferten wieder verwendbaren Instrumente wurden ausschließlich für den chirurgischen Gebrauch konstruiert und dürfen zu keinen anderen Zwecken benutzt werden. Unsachgemäße Handhabung und sorglose Pflege sowie zweckentfremdeter Gebrauch können zu vorzeitigem Verschleiß der Instrumente führen. Die Produkte sind bei der Auslieferung nicht sterilisiert.

Reinigungsvorbereitung

Fabrikneue Instrumente müssen vor der ersten Anwendung den gesamten Aufbereitungsprozess durchlaufen. Instrumente unmittelbar nach Anlieferung aus den Folienverpackungen entnehmen und in trockenen Räumen bei gleichbleibender Raumtemperatur luftoffen lagern, um Kondensationsbildung zu vermeiden. Die Instrumente keinen Sonnenlichteinstrahlungen oder Dämpfen durch Chemikalien (Säuren oder scharfe Reinigern) aussetzen. Vor der ersten Sterilisation alle Schutzkappen und Folien vollständig entfernen und anschließend reinigen.

Gebrauchte Instrumente unmittelbar nach Beendigung des Eingriffs von Blut, Gewebe und Arzneimittel reinigen. Instrumente in eine freigegebene Lösung eines kombinierten Reinigungs- und Desinfektionsmittels, das keine proteinfixierende Wirkung besitzt, einlegen. Dosierung des Herstellers beachten. Nicht in NaCl Lösung einlegen, ansonsten Gefahr für Loch- bzw. Spannungsriss-Korrosion

Überfüllung von Instrumentensieben und Wasch-Trays vermeiden.

Gelenkinstrumente vor dem Aufbereiten öffnen. Zerlegbare Instrumente gemäß Bedienungsanleitung (Piktogramm) zur Reinigung zerlegen. Reinigungsgerechtes Zubehör verwenden. Für die manuelle Reinigung nie Metallbürsten oder Metallschwämme verwenden. Spülmaschinen und Ultraschallanlagen nicht überladen. Spül- oder Schallschatten vermeiden. Dosierung, Einwirkzeit und Einwirktemperatur bei der Desinfektion und Reinigung unbedingt einhalten. Nach der Reinigung sorgfältig spülen. Möglichst vollentsalztes (demineralisiertes) Wasser verwenden. Nach dem Spülen ausreichend trocknen. Abgenutzte, korrodierte, deformierte, poröse oder anderweitig beschädigte Instrumente aussortieren.

Aus hygienischen Gründen müssen Instrumente, die zur Reparatur eingesandt werden komplett aufbereitet werden. Gelenkinstrumente nach jeder Aufbereitung mit einem Pflegemittel auf Basis von Paraffinöl behandeln (gilt nicht für flexible Endoskope und Zubehör). Funktionsprüfung in zusammengebautem Zustand durchführen. Instrumente mit Rastensperre vor der Sterilisation nur im ersten Zahn schließen.

Als Sterilisationsverfahren empfehlen wir die Dampfsterilisation (üblicherweise mit Sattedampf bei 134° C)

Sterilisation ist kein Ersatz für Sauberkeit!

Die Broschüre "Instrumenten-Aufbereitung richtig gemacht" des Arbeitskreis Instrumenten-Aufbereitung dient als Anhalt.

Reda Instrumente GmbH
78532 Tuttlingen

IMPORTANT INFORMATION CONCERNING PREPARING AND STERILIZING SURGICAL INSTRUMENTS

Dear Sirs,
please read the following instructions very carefully before using the instruments.

1. INITIAL USE

All instruments which are being used for the first time must be thoroughly cleaned, rinsed and then sterilized before using.

2. TREATING INSTRUMENTS AFTER USAGE

- a.) The instruments might be immediately thoroughly cleaned and disinfected. Please follow the manufacturer's instructions when using cleaning agents and disinfectants.
- b.) Instruments which may be dismantled must be cleaned and disinfected after being taken apart.
- c.) Cleaning may be carried out either manually or with a machine. Care should be taken that only cleaning agents and disinfectants are used, which are changed daily.
- d.) Following chemical disinfection and manual cleaning, all instruments must always be thoroughly rinsed under running water.
- e.) The temperature of water used in a machine for cleaning should not exceed 45°C.
- f.) Whether cleaning is carried out manually or by machine, we especially ask you to ensure that the correct dosage for cleaning solutions or the correct combination of disinfectant and cleaning solution, is employed. Similar importance should be applied to the length of time the agents require to perform properly and to the temperature set.
- g.) Hinged instruments should be opened before cleaning.
- h.) Please ensure that the perforated instrument trays, when loaded, do not exceed 10 kg in weight.
- i.) Please take care that when instruments are being cleaned they are arranged proper in a manne that fluids can circulate freely.
- j.) Deposits remaining after the cleaning process must be completely removed in the first rinse which now follows. The optimum temperature for final rinsing has proved to be between 70° and 90° C. Please use only purified water in this final cleaning stage.
- k.) The instruments must be carefully dried after cleaning and rinsing is completed.
- l.) Moving parts and the cutting edges of shears and scissors must be treated with preservatives which are both suitable and physiologically safe.

3. TESTING FOR CORRECT FUNCTIONING

- a.) Instruments must be carefully and thoroughly checked before every occasion that they are used.

- b.) After each time they are cleaned, the instruments must be macroscopically clean, i.e., visibly free from proteinbased residues and other soiling.
- c.) Care should be taken so that cracks, breakages and corrosion are noticed.
- d.) Instruments with flecks should be separated and taken out for special treatment.
- e.) All moving parts as well as working tips and blades should be checked with special care.
- f.) Checking should be carried out according to the extent to which the instruments will be used.
- g.) Instruments which are in any way defective or damaged should be immediately sorted out from the others.

4. STERILIZATION

- a.) All stainless steel surgical instruments supplied by us may be sterilized in an autoclave.
- b.) Please follow the manufacturer's operating instructions when using autoclave. All machines used must comply with all current quality and other standards.
- c.) Instruments are being sterilized/ autoclaved at a temperature of 134°C.
- d.) Sterilization packing material must comply with all current standards.
- e.) Instruments with ratchets or self-retaining mechanisms should be sterilized opened or in the first ratchet position.
- f.) Please ensure that perforated instrument trays, when loaded do not exceed 10 kg in weight.

5. IN GENERAL

- a.) All surgical instruments supplied by us have been thoroughly inspected before dispatch and leave our factory in perfect condition. Damage which can arise as a result of transporting, cleaning, preserving, sterilizing or storing, must be prevented.
- b.) Please handle surgical instruments always with the utmost care.
- c.) Instruments must be stored in a clean and dry place.
- d.) If you have any queries or problems please contact us at any time:

We should like to point out that, if the above-mentioned directions are not followed or the instruments supplied by us are not properly used, all guarantee claims become void and any consequences must be borne by yourselves.

SUGERENCIAS PARA LA LIMPIEZA, ESTERILIZACIÓN Y MANTENIMIENTO DE INSTRUMENTOS QUIRÚRGICOS

ENJUAGADO

Tras el uso enjuagar enseguida los instrumentos bajo un chorro de agua caliente (no hirviendo). El enjuagado debe servir para quitar los residuos de sangre, mucosas y tejidos.

LIMPIEZA

Si la limpieza no se efectúa inmediatamente después del enjuagado, los instrumentos tienen que sumergirse en una solución de agua y detergente con PH neutro (7)

Para los instrumentos muy delicados (algunos tipos de porta agujas o tijeras se aconseja una limpieza manual: ver punto "C").

a.- Limpieza en la pila de ultrasonido

Los instrumentos tienen que estar en la pila el tiempo necesario recomendado por el fabricante para efectuar el ciclo del lavado, generalmente de 5 a 10 minutos.

Los instrumentos con bisagras o juntas (articulaciones) tienen que sumergirse en la pileta en posición abierta.

Asegurarse de que las hojas afiladas de las tijeras, bisturíes para gingivectomía, curetas, etc. no estén en contacto con otros instrumentos.

Todos los instrumentos deben estar completamente sumergidos en la solución de lavado.

No poner instrumentos de diferentes metales (acero inoxidable, instrumentos cromados, latón, etc.) en el mismo ciclo de lavado.

Cambiar a menudo la solución para el lavado, como mínimo todas las veces que lo recomienda el fabricante de la pileta de ultrasonidos.

Enjuagar concienzudamente los instrumentos con agua corriente tras lavado con ultrasonidos para quitar los residuos de la solución de lavado.

b.- Limpieza con lavadora

Seguir las indicaciones del fabricante. Asegurarse de que los instrumentos hayan sido lubricados tras el último ciclo de lavado y antes del ciclo de esterilización.

c.- Limpieza manual

La mayor parte de los fabricantes de instrumentos indican el lavado con los ultrasonidos como el modo mejor y más eficaz para limpiar los instrumentos quirúrgicos, especialmente los que tienen bisagras, cierres y en general articulaciones. Si la limpieza con los ultrasonidos no es posible, se aconseja usar el método siguiente:

- Usar cepillos rígidos de plástico, nylon, etc.
- Cepillar concienzudamente los instrumentos más delicados y, si es posible, enjuagar, limpiar y esterilizar estos instrumentos separadamente.
- Verificar que toda la superficie de estos instrumentos esté limpia.
- Tras haber cepillado los instrumentos, enjuagarlos bajo el chorro de agua corriente.
- Durante el enjuagado abrir y cerrar las tijeras, las pinzas hemostáticas, los porta agujas y los demás instrumentos con bisagras o juntas y asegurarse de que las partes internas de las bisagras estén perfectamente enjuagadas como la superficie externa del instrumento.

SECADO, LUBRIFICACIÓN E INSPECCIÓN

Tras las operaciones de limpieza y de enjuagado, los instrumentos quirúrgicos tienen que ser secados perfectamente.

Todos los instrumentos con juntas o bisagras (acción "metal contra metal") como tijeras, pinzas hemostáticas, porta agujas, fórceps de extracción, etc., tienen que ser lubricados. Se aconsejan lubricantes específicos para el instrumental quirúrgico. No usar aceites o lubricantes industriales.

A este punto es buena norma inspeccionar el estado de cada instrumento y verificar el funcionamiento según el uso específico. Controlar y asegurarse de que:

- Las hojas de las tijeras estén lisas de arriba abajo y de que, una vez cerradas, no hagan juego. Probar las tijeras cortando gasa muy fina. Tres cuartas parte de la hoja tienen que cortar la gasa sin retenerla.

- Las puntas de las pinzas estén al mismo nivel.
- Las pinzas hemostáticas y los porta agujas no dejen pasar la luz entre las puntas cuando estén cerradas, se abran y cierren fácilmente y que las bisagras no estén demasiado flojas.
- Controlar el desgaste de la porta agujas sobre la superficie interna de las puntas.
- Las cánulas metálicas de aspiración estén bien limpias en su interior.
- Los instrumentos cortantes y los bisturíes tengan las hojas bien afiladas y no estropeadas.

ESTERILIZACIÓN EN AUTOCLAVE

Tras haber enjuagado, limpiado, secado, lubricado e inspeccionado los instrumentos, éstos pueden ser preparados para la esterilización separadamente o en serie.

Instrumentos individuales:

Las bolsas especiales monouso son el ideal para contener los instrumentos. Asegurarse de que las bolsas que contendrán los instrumentos con cierres y articulaciones (pinzas hemostáticas, porta agujas, etc.) sean lo bastante grandes como para contener los citados instrumentos en posición abierta.

Instrumentos en serie:

Poner los instrumentos en los especiales cestos o bandejas de acero inoxidable. Poner los instrumentos más pesados en la parte inferior cuando sean necesarias varias bandejas.

No cerrar nunca los instrumentos durante el ciclo en autoclave. Un instrumento cerrado no estará nunca bien esterilizado, ya que el vapor no puede penetrar en la parte de cierre a contacto "metal contra metal". En el instrumento podría además romperse en la parte de la bisagra a causa de la expansión del metal debida al calor durante el ciclo del autoclave.

No cargar demasiado la cámara del autoclave ya que algunos instrumentos podrían formar "zonas de sombra" sobre otros en los que el vapor no penetraría.

ATENCIÓN

Al final del ciclo de esterilización - antes del ciclo de secado- abrir ligeramente la portezuela del autoclave y proceder con el ciclo desecado según las instrucciones del fabricante. Si la portezuela del autoclave se abriese completamente antes del ciclo de secado, el aire frío de la habitación entraría en la cámara del autoclave causando la formación de condensación sobre los instrumentos y de consecuencia aparecerían las manchas de agua que vemos a menudo en los mismos.

ESTERILIZACIÓN EN FRÍO:

La mayor parte de las soluciones para la esterilización en frío esterilizan los instrumentos completamente tras 10 horas de inmersión. Esta acción química prolongada puede ser más perjudicial para los instrumentos que el ciclo normal de 20 minutos en autoclave.

Si los instrumentos tienen necesidad de ser simplemente "desinfectados", el proceso en frío es adecuado, ya que la desinfección tiene lugar en 10 minutos solamente.

Recuerde bien la diferencia entre:

ESTÉRIL - término absoluto (ningún organismo logra sobrevivir) y

DESINFECTADO - perfectamente limpio.

Usen siempre la técnica más adecuada de esterilización/limpieza de los instrumentos según el uso que se haga posteriormente de ellos.

Recuerden que la esterilización de los instrumentos no sustituye la limpieza de los mismos.

Recomendamos no volver a usar ni esterilizar los artículos de un solo uso.

Si se tratan en el modo correcto los instrumentos contruidos con las modernas aleaciones inoxidables pueden durar muchos años.

INDICAZIONI PER LA CURA, PULITURA E LA STERILIZZAZIONE DELLO STRUMENTARIO CHIRURGICO RISTERILIZZABILE

Misure preventive anticorrosione

- 1) Raggruppare accuratamente gli strumenti correttamente confezionati e sterilizzati prima dell'operazione; selezionarli secondo l'intervento. Verificare sempre che la confezione esterna sia integra e che lo strumento stesso non sia danneggiato.
- 2) Assicurarli tramite l'indicatore di sterilizzazione collocato all'interno del vaglio che il contenuto sia stato sterilizzato.
- 3) Disporre gli strumenti seguendo l'ordine di utilizzo durante l'operazione; lasciare gli strumenti non necessari nel vaglio; predisporre gli strumenti solo immediatamente prima dell'operazione.
- 4) Nel corso dell'operazione rimuovere dagli strumenti sangue ed altri materiali biologici; dopo l'uso, riporre gli strumenti nel corretto alloggiamento.
- 5) Risciacquare opportunamente gli strumenti cavi, al fine di evitare l'adesione di sangue e polvere d'osso.
- 6) Per la pulitura degli strumenti utilizzare una soluzione lattata o una soluzione salina, ma non immergerli nelle suddette soluzioni.
- 7) Iniziare l'operazione di pulitura subito dopo l'intervento. Strumenti utilizzati su pazienti con possibili infezioni: smaltire in modo analogo, eliminando sangue, polvere d'osso parti di tessuto in eccesso.
- 8) Pulire gli strumenti in un luogo previsto nell'ambito della sala operatoria.

Nel caso in cui gli strumenti vadano collocati direttamente nella centrale di sterilizzazione, è necessario dapprima coprirli, per evitare il rischio di contaminazione ai danni del personale o dell'ambiente circostante.

Disinfezione

Durante l'uso di disinfettanti chimici è necessario osservare scrupolosamente le indicazioni del produttore; utilizzare le soluzioni sempre previa diluizione. Nella fase termica di disinfezione con acqua bollente assicurarsi che l'acqua sia priva di corpi estranei.

Pulitura

Indipendentemente dal metodo utilizzato per la pulitura (meccanico o manuale) si raccomanda di verificare attentamente quale detergente vada utilizzato con ciascun metodo. Valori pH consigliati: tra 7,0 e 8,5.

1) Pulitura meccanica

Osservare scrupolosamente le istruzioni d'uso fornite dal produttore della macchina pulitrice. Predisporre gli

strumenti per la pulitura meccanica. Tutti gli strumenti appuntiti e delicati dovrebbero essere puliti manualmente.

Non sovraccaricare i vagli, mettere gli strumenti pesanti sul fondo del vaglio. Se necessario, immergere e risciacquare gli strumenti molto sporchi (strumenti cavi), prima di collocarli nella lavatrice.

2) Pulitura ad ultrasuoni

(fa parte dei metodi di pulitura meccanica)

Prima di inserire uno strumento nel bagno ad ultrasuoni, rimuovere i materiali organici in eccesso. I bagni ad ultrasuoni sono consigliati per le filettatrici o gli strumenti con solchi profondi. L'ultrasuono deve essere seguito da un programma di risciacquo normale.

3) Pulitura manuale

Richiede diverse spazzole in nylon, una canna da soffio ed un ugello da soffio/ un dispositivo ad aria compressa pulito, detergenti e solventi come per la pulitura meccanica.

Per gli additivi di pulitura osservare le indicazioni fornite dal produttore.

Per la pulitura degli strumenti dotati di cannula, passare più volte lo spazzolino di nylon attraverso la cannula eseguendo movimenti rotatori (non utilizzare spazzole in lana d'acciaio/metallo) fino alla completa rimozione dei residui eliminabili con questo metodo.

Soffiare poi con aria compressa nella cannula.

4) Asciugatura

Ogni strumento deve essere asciugato completamente sia internamente che esternamente per evitare la formazione di ruggine o malfunzionamenti.

Indicazioni per la sterilizzazione della strumentazione

Pulire immediatamente ed asciugare bene gli strumenti usati, non utilizzare detergenti e disinfettanti con additivi fortemente acidi o alcalini (ad es. soda, soda caustica o acidi)!

Sterilizzare la strumentazione solo a vapore A 134°!

Prima della sterilizzazione, assicurarsi che gli strumenti siano perfettamente funzionanti ed integri. La sterilizzazione non sostituisce la pulitura.

DIAGNOSTIK DIAGNOSTICS DIAGNÓSTICO DIAGNOSTICA	7 - 12
<hr/>	
SKALPELLE SCALPELS BISTURÍES BISTURI	13 - 18
<hr/>	
SCHEREN SCISSORS TIJERAS FORBICI	19 - 48
<hr/>	
PINZETTEN FORCEPS PINZAS PINZETTE	49 - 74
<hr/>	
KLEMMEN CLAMPS PINZAS PINZE	75 - 90
<hr/>	
NADELHALTER NEEDLE HOLDERS PORTA-AGUJAS PORT'AGHI	91 - 98
<hr/>	
HAKEN HOOKS GANCHOS UNCINI	99 - 116
<hr/>	
SPREIZER SPREADER SEPARADORES DIVARICATORI	117 - 156
<hr/>	
ZANGEN FORCEPS PINZAS PINZE	157 - 170
<hr/>	
SCHÄDELHALTER, DRAHTSÄGEN, TREPHINEN SKULL HOLDER, WIRE SAWS, TREPHINE CRÁNEO TITULAR, ALAMBRE DE SIERRAS, TREPANO SKULL TITOLARE, SEGHE A FILO, TRAPANO	171 - 178

LÖFFEL, MEISSEL CURETTES, CHISELS CUCHARILLAS, CINCELES CUCCHIAI, SCALPELLI	179 - 200
ELEVATORIEN, RASPATORIEN, DISSEKTOREN ELEVATORS, RASPATORIES, DISSECTORS ELEVADORES, PERIOSTÓTOMOS, DISECTORES ELEVATORI, PERIOSTOTOMI, DISSETTORI	201 - 224
SAUGROHRE SUCTION TUBES TUBOS DE ASPIRACIÓN TUBI D'ASPIRAZIONE	225 - 230
LAMINEKTOMIE LAMINECTOMY LAMINECTOMIA LAMINECTOMIA	231 - 240
MIKRO-RUNDGRIFFINSTRUMENTE MICRO INSTRUMENTS WITH ROUND HANDLE INSTRUMENTOS PARA MICROCIRUGÍA CON MANGOS REDONDOS STRUMENTI PER MICROCHIRURGIA CON MANICO ROTONDO	241 - 250
HYPOPHYSEKTOMIE HYPOPHYSECTOMY HIPOFISECTOMÍA IPOFISECTOMIA	251 - 264
HIRNSPATEL BRAIN SPATULAS ESPÁTULAS CEREBRALES SPATOLE CEREBRALI	265 - 272
STANZEN PUNCHES PINZAS SACABOCADO PINZE LAMINOTOMO	273 - 280
BOHRAPPARATE BONE HAND DRILLS PERFORADORES DE MANO PERFORATORI A MANO	281 - 284
BIPOLARE KOAGULATION BIPOLAR COAGULATION COAGULACIÓN BIPOLAR COAGULAZIONE BIPOLARE	285 - 294

CLIPS CLIPS CLIPS CLIPS PER ANEURISMA	295 - 297
SÄTZE SET SET SET	299 - 305
NUMMERNVERZEICHNIS NUMERICAL INDEX INDICE NUMÉRICO INDICE NUMERICO	307 - 317
ALPHABETISCHER INDEX ALPHABETICAL INDEX INDICE ALFABÉTICO INDICE ALFABETICO	319 - 352

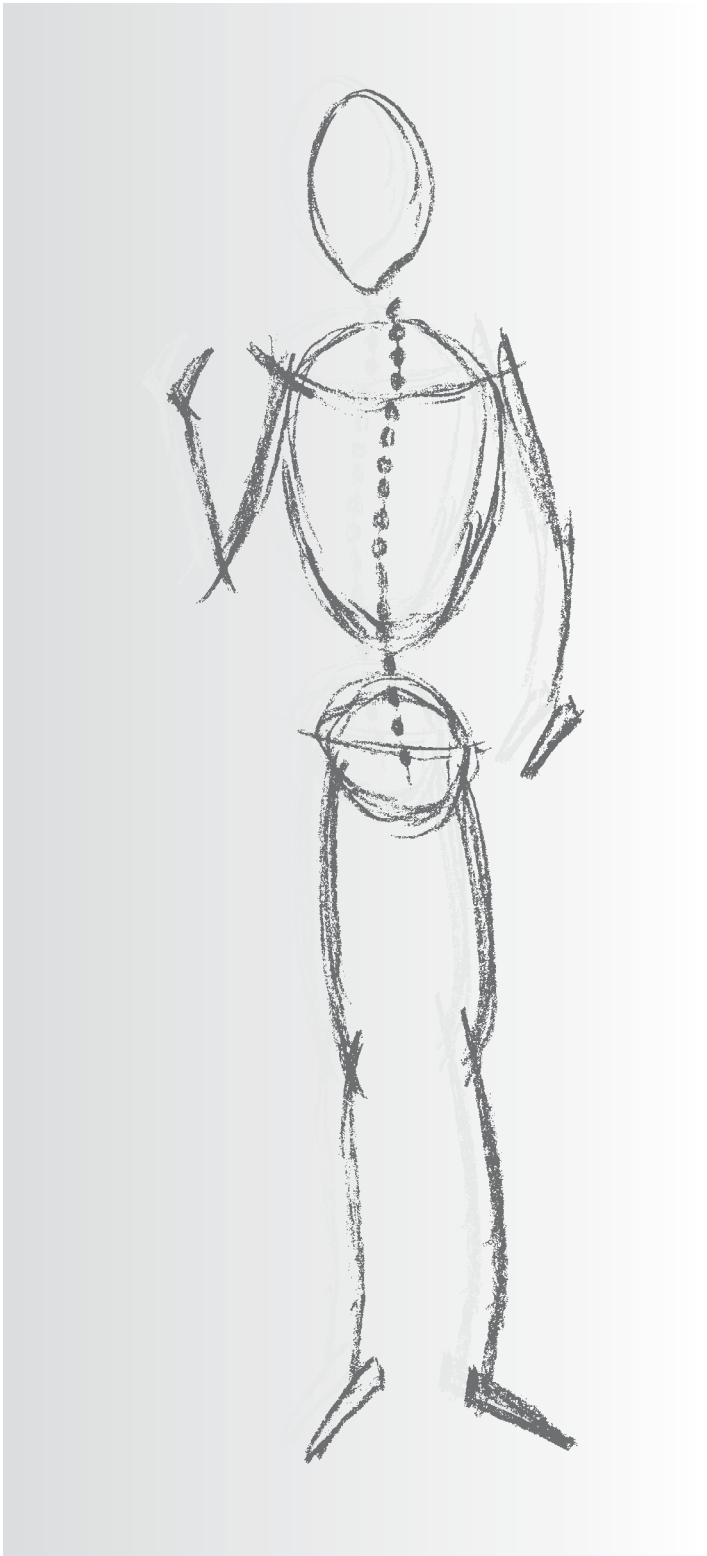

Reda Instrumente GmbH
Gänsäcker 34 - P.O. Box 131
D-78532 Tuttlingen

DIAGNOSTIK

DIAGNOSTICS

DIAGNÓSTICO

DIAGNOSTICA

Perkussionshämmer
Percussion Hammers
Martillos de percusión
Martelli da percussione



TAYLOR - USA Mod.
03288-17 17 cm, 6³/₄"
03288-20 20 cm, 8"



BABINSKY
03292-22 22 cm, 8³/₄"

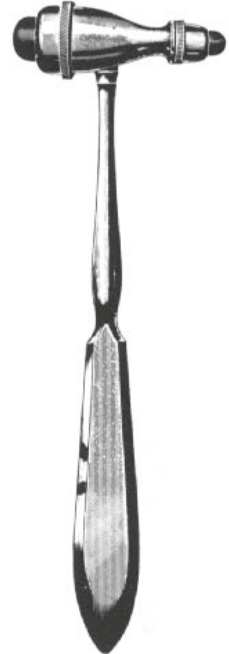

TROEMNER
03294-24 24 cm, 9¹/₂"



DEJERINE
03304-20 20 cm, 8"

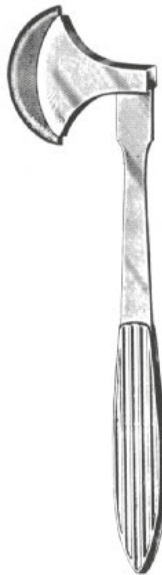

BERLINER
03306-17 17 cm, 6³/₄"

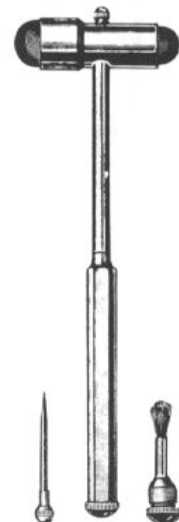

BUCK
03308-18 18 cm, 7"

Hämmer
Bone Hammers and Mallets
Martillos y mazos
Martelli



WILLIGER
33691-34
24 cm, 9½"
340 g

Ø 25 mm



33694-03
Ersatzbacken
Nylon Caps
Tapas de repuesto
Battenti di ricambio
33694-01
18,5 cm, 7¼"
135 g

Ø 42 mm

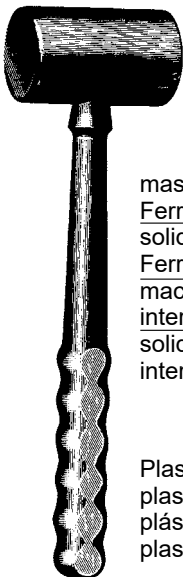

massiv, mit auswechselbaren
Ferrozellbacken
solid, with interchangeable
Ferrozell jaws
macizo, con tapas
intercambiables de Ferrozell
solido, con placche
intercambiabili in Ferrozell

Plastik
plastic
plástico
plastica

33695-40
26 cm, 10¼"
250 g

Ø 40 mm

Ø 30 mm



33699-17
26,5 cm, 10½"
530 g

Hämmer
Bone Hammers and Mallets
Martillos y mazos
Martelli

Ø 30 mm



33700-01-01
Ersatzbacken
Nylon Caps
Tapas de repuesto
Battenti di ricambio

33700-01
24,5 cm, 9¾" 215 g

Ø 30 mm



COTTLE
33700-05
18 cm, 7" 240 g

Ø 40 mm



OMBREDANNE
33700-07
25 cm, 10" 700 g

Ø 35 mm



WAGNER
33709-00
24,5 cm, 9¾" 215 g

komplett mit:

1 Paar Metallbacken 33709-01

1 Paar Kunststoffbacken 33709-02

complete with:

1 pair of metal discs 33709-01

1 pair of plastic discs 33709-02

completo con:

1 par de mandibulas de metal 33709-01

1 par de zapatos de plástico 33709-02

completo di battenti:

1 paio di ganasce di metallo 33709-01

1 paio di dischi di plastica 33709-02

Prüf- und Meßinstrumente, Stimmgabel
 Examination and Measuring Instruments, Tuning Fork
 Instrumentos para exámenes y medición, Diapason
 Strumenti per esaminare e misurare, Diapason



03360-01
 Messbereich bis 150 mm
 measuring range up to 150 mm
 campo de medición hasta 150 mm
 calibre con scala fino a 150 mm



WARTENBERG
 03320-19
 19 cm, 7½"

Kunststoffgehäuse
 In plastic case
 Caja de plástico
 Custodia di plastica



03350-15
 1,8 m

mm & Inch

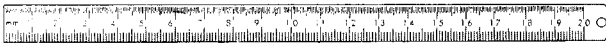

Metall		
03340-10	10 cm	4"
03340-15	15 cm	6"
03340-20	20 cm	8"
03340-30	30 cm	12"
03340-50	50 cm	20"



45075-00

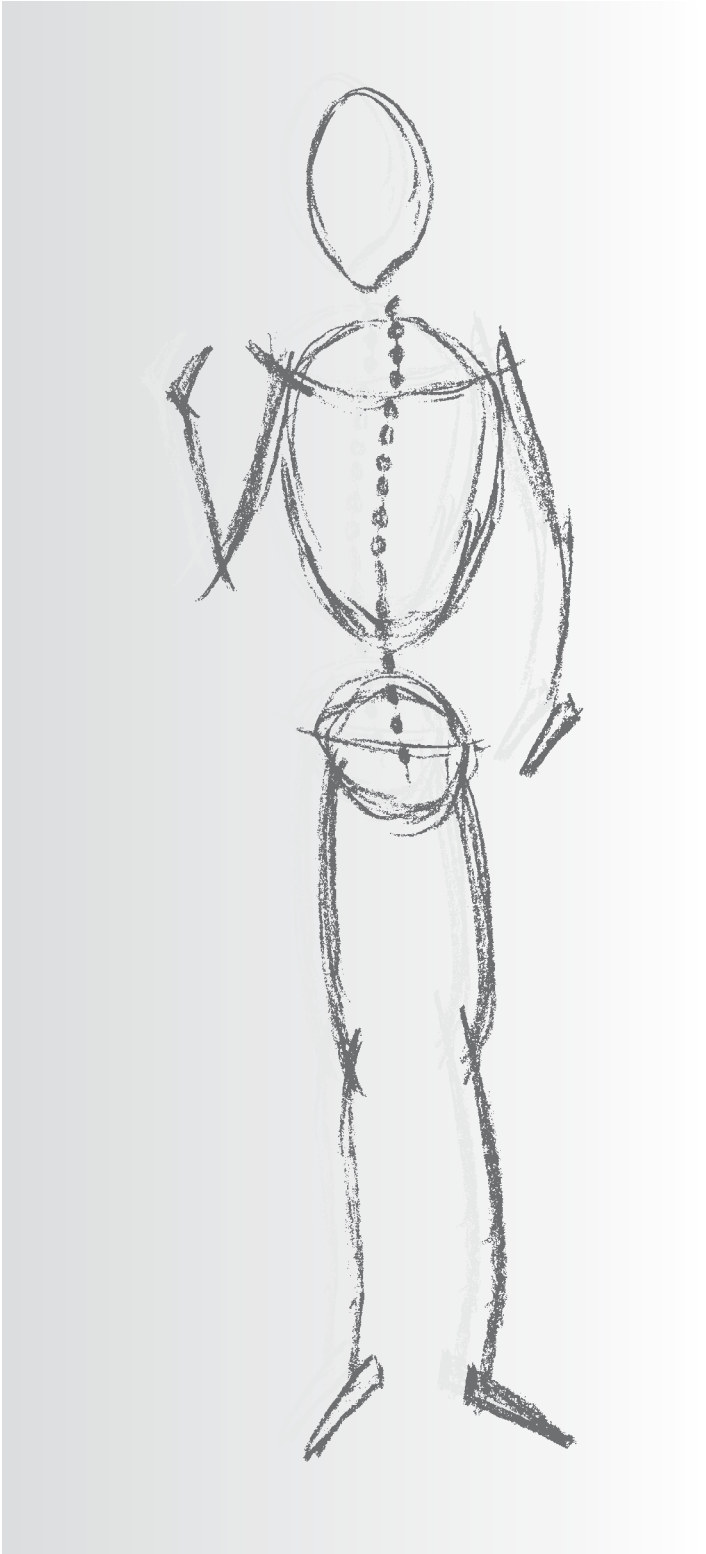

Reda Instrumente GmbH
Gänsäcker 34 - P.O. Box 131
D-78532 Tuttlingen

SKALPELLE

SCALPELS

BISTURÍES

BISTURI

Skalpell-Griffe
Scalpel Handles
Mangos de bisturios
Manici per lame bisturi

passend zu den Klängen
for blades
para las hojas
per lame bisturi

Ⓐ No. 10, 11, 12, 13, 14, 15, 16, 17, 18, 19



07103-00
Fig. 3

Ⓐ



07103-01
Fig. 3 grad.

Ⓐ



07106-01
14,5 cm 5¾"

Ⓐ

Skalpelli-Griffe
 Scalpel Handles
 Mangos de bisturíes
 Manici per lame bisturi

passend zu den Klängen
 for blades
 para las hojas
 per lame bisturi

Ⓐ No. 10, 11, 12, 13, 14, 15, 16, 17, 18, 19



07107-00
 Fig. 7
 Ⓐ



07107-01
 Fig. 7K
 Ⓐ



07109-10 10,0 cm, 4"
 07109-13 13,0 cm, 5"
 07109-15 15,5 cm, 6"



07161-00



07162-00



07165-00



07167-00

Packung mit 10 Stück
 box of 10
 en cajas de 10 pzas
 confezione di 10

Skalpelli-Griffe
 Scalpel Handles
 Mangos de bisturios
 Manici per lame bisturi



CASPAR



93380-13
 135 mm / 5½"



93380-15
 155 mm / 6"



93380-18
 180 mm / 7"



93380-20
 200 mm / 8"



LANDOLT
 93385-21 210 mm / 8¼"
 93385-25 250 mm / 10"

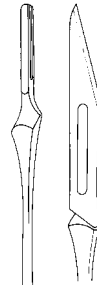

horizontal

LANDOLT
 93390-21 210 mm / 8¼"



Klingenbrecher
Blade Breakers
Rompe-hojas
Rompi lama di rasoio



TROUTMAN-CHRIS
07290-09 9 cm, 3½"



REDA
07291-11 11 cm, 4¾"



CASTROVIEJO
07294-13 13 cm, 5½"

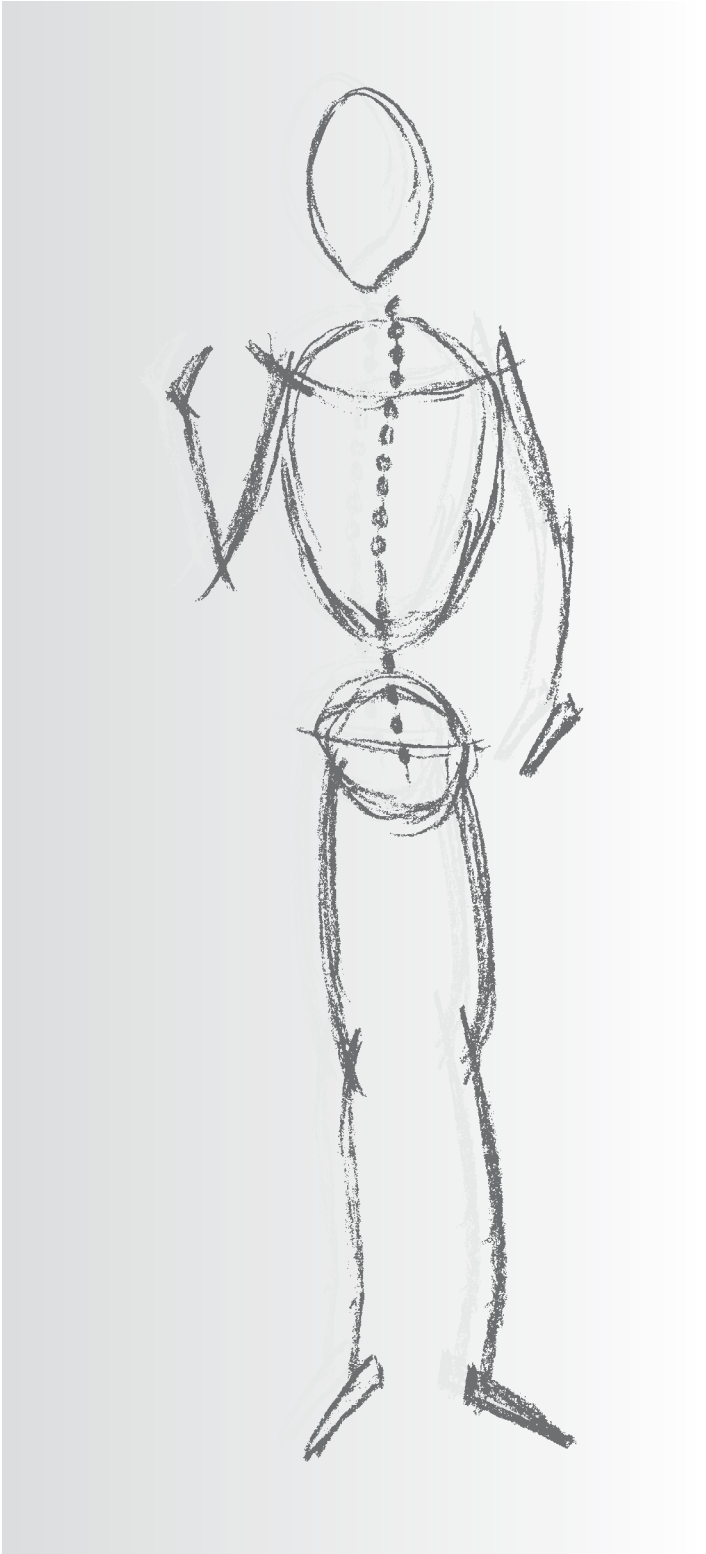

Reda Instrumente GmbH
Gänsäcker 34 - P.O. Box 131
D-78532 Tuttlingen

SCHEREN

SCISSORS

TIJERAS

FORBICI

Chirurgische Scheren
 Operating Scissors
 Tijeras para cirugía
 Forbici per chirurgia



STANDARD —
 09102-13 13,0 cm, 5"
 09102-14 14,5 cm, 5¾"
09104-14 TC
 09102-16 16,5 cm, 6½"
 09102-18 18,5 cm, 7¼"



STANDARD —
 09110-13 13,0 cm, 5"
 09110-14 14,5 cm, 5¾"
09114-14 TC
 09110-16 16,5 cm, 6½"
 09110-18 18,5 cm, 7¼"



STANDARD —
 09120-13 13,0 cm, 5"
 09120-14 14,5 cm, 5¾"
09124-14 TC
 09120-16 16,5 cm, 6½"
 09120-18 18,5 cm, 7¼"

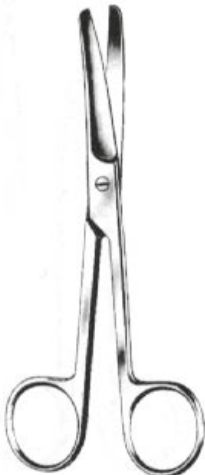

STANDARD —
 09103-13 13,0 cm, 5"
 09103-14 14,5 cm, 5¾"
09105-14 TC
 09103-16 16,5 cm, 6½"
 09103-18 18,5 cm, 7¼"



STANDARD —
 09111-13 13,0 cm, 5"
 09111-14 14,5 cm, 5¾"
09115-14 TC
 09111-16 16,5 cm, 6½"
 09111-18 18,5 cm, 7¼"



STANDARD —
 09121-13 13,0 cm, 5"
 09121-14 14,5 cm, 5¾"
09125-14 TC
 09121-16 16,5 cm, 6½"
 09121-18 18,5 cm, 7¼"

Chirurgische Scheren
Operating Scissors
Tijeras para cirugía
Forbici per chirurgia

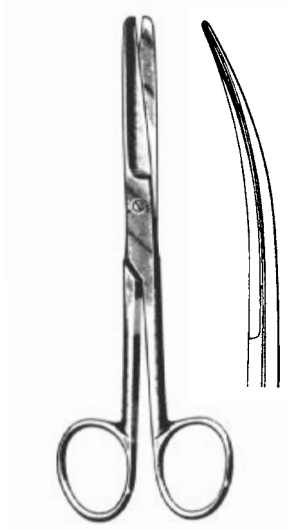

DEAVER
09130-14 14 cm 09131-14
5½"

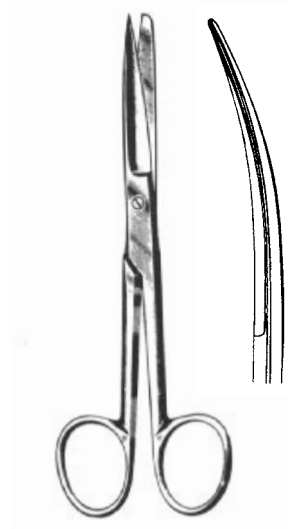

DEAVER
09140-14 14 cm 09141-14
5½"

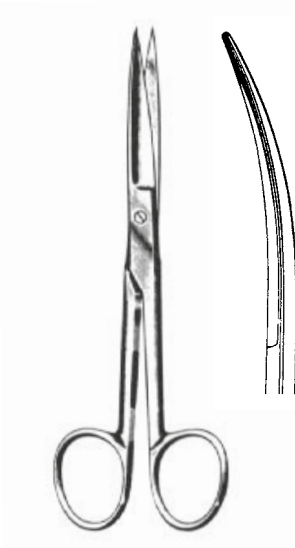

DEAVER
09150-14 14 cm 09151-14
5½"

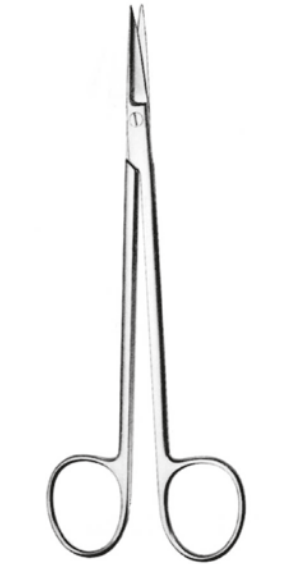

KELLY
09540-16 09541-16
09542-16 TC 09543-16 TC
16 cm, 6¼"

Präparierscheren
Dissecting Scissors
Tijeras de disección
Forbici per dissezione



MAYO

09160-14	14,5 cm	09161-14
09164-14 TC	14,5 cm	09165-14 TC
	5¾"	
09160-17	17,0 cm	09161-17
09164-17 TC	17,0 cm	09165-17 TC
	6¾"	
09160-23	23,0 cm	09161-23
09164-23 TC	23,0 cm	09165-23 TC
	9"	



MAYO-STILLE

09170-15	15,0 cm	09171-15
09174-15 TC	15,0 cm	09175-15 TC
	6"	
09170-17	17,0 cm	09171-17
09174-17 TC	17,0 cm	09175-17 TC
	6¾"	
09170-21	21,0 cm	09171-21
09174-21 TC	21,0 cm	09175-21 TC
	8¾"	

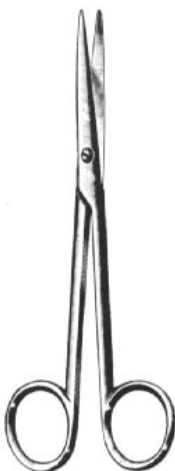

LEXER

09190-16
09194-16 TC
16 cm, 6¼"

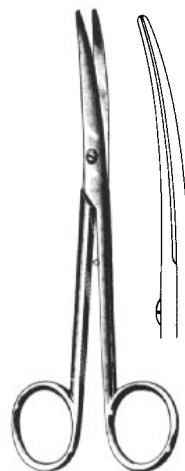

LEXER

09191-16
09195-16 TC
16 cm, 6¼"

Präparierscheren
Dissecting Scissors
Tijeras de disección
Forbici per dissezione



- METZENBAUM**
- 09280-12 **09284-12 TC**
12 cm, 4¾"
 - 09280-15 **09284-15 TC**
15 cm, 6"
 - 09280-18 **09284-18 TC**
18 cm 7"
 - 09280-20 **09284-20 TC**
20 cm 8"
 - 09280-23 **09284-23 TC**
23 cm 9"
 - 09280-25 **09284-25 TC**
25 cm 10"



- METZENBAUM**
- 09281-12 **09285-12 TC**
12 cm, 4¾"
 - 09281-15 **09285-15 TC**
15 cm 6"
 - 09281-18 **09285-18 TC**
18 cm, 7"
 - 09281-20 **09285-20 TC**
20 cm, 8"
 - 09281-23 **09285-23 TC**
23 cm, 9"
 - 09281-25 **09285-25 TC**
25 cm, 10"



- METZENBAUM FINO**
- 09282-15 **09286-15 TC**
15 cm, 6"
 - 09282-18 **09286-18 TC**
18 cm, 7"
 - 09282-20 **09286-20 TC**
20 cm, 8"
 - 09282-23 **09286-23 TC**
23 cm, 9"
 - 09282-25 **09286-25 TC**
25 cm, 10"

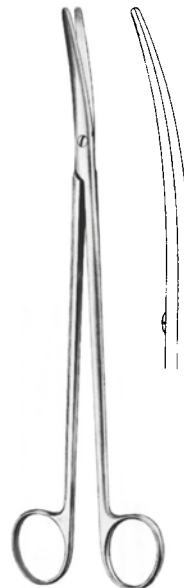

- METZENBAUM FINO**
- 09283-15 **09287-15 TC**
15 cm, 6"
 - 09283-18 **09287-18 TC**
18 cm, 7"
 - 09283-20 **09287-20 TC**
20 cm, 8"
 - 09283-23 **09287-23 TC**
23 cm, 9"
 - 09283-25 **09287-25 TC**
25 cm, 10"

Präparierscheren
Dissecting Scissors
Tijeras de disección
Forbici per dissezione



METZENBAUM BLACK



09281-15B
14,5 cm, 5¾"



09281-18B
18 cm, 7"



09281-20B
20 cm, 8"



09283-18B
18 cm, 7"

fein
delicate
fina
delicate



09283-20B
20 cm, 8"

fein
delicate
fina
delicate

Präparierscheren
Dissecting Scissors
Tijeras de disección
Forbici per dissezione



fein
delicate
fina
delicate

BABY-METZENBAUM BLACK
09283-15B
14,5 cm, 5¾"



fein
delicate
fina
delicate

BLACK
09371-11B
11,5 cm, 4½"

Präparierscheren
Dissecting Scissors
Tijeras de disección
Forbici per dissezione

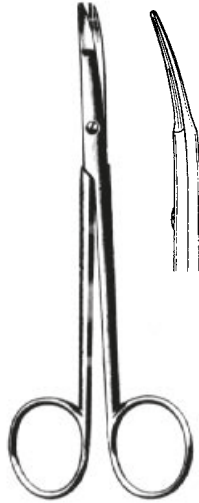

KILNER

- 09310-12 12 cm, 4³/₄" **09314-12 TC**
- 09310-15 15 cm, 6"
- 09312-12 12 cm, 4³/₄"



fein
delicate
fina
delicate

JAMESON WERBER
09322-13 13 cm, 5"

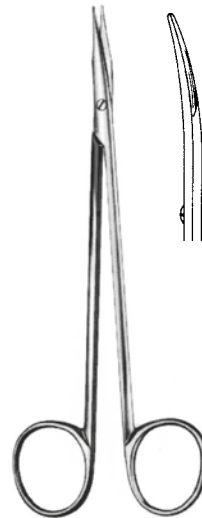

REYNOLDS -
09321-15 15 cm, 6"
09321-18 18 cm, 7"
09325-15 TC 15 cm, 6"

Feine Scheren, Nerv-Präparierscheren
 Delicate Scissor, Nerve Dissecting Scissors
 Tijeras finas, Tijeras de diseccion para nervios
 Forbici delicate per preparazione nervi

Iris - Standard



abgewinkelt
 angled
 angulada
 angolata

09340-09	9 cm, 3½"	09341-09	09346-11	11 cm, 4¾"
09340-10	10 cm, 4"	09341-10		
09340-11	11 cm, 4¾"	09341-11		
09344-11 TC	11 cm, 4¾"	09345-11 TC		

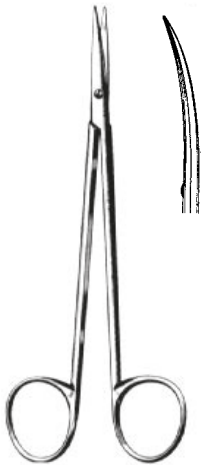

09582-15 09583-15
 15 cm, 6"



TOENNIS-ADSON
 09610-18
 18 cm, 7"

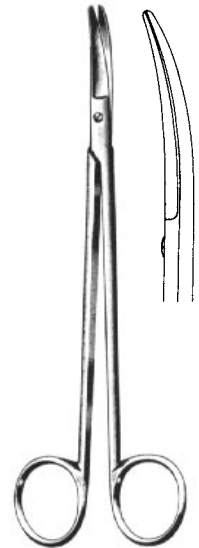

TOENNIS-ADSON
 09611-18
 18 cm, 7"

Feine Scheren
Delicate Scissors
Tijeras finas
Forbici delicate

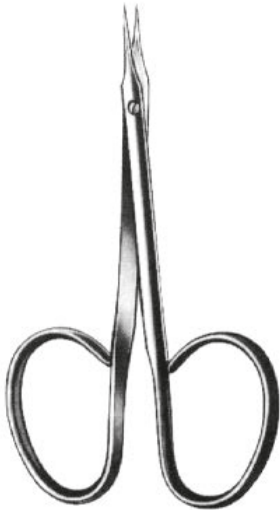

— GRADLE —
09350-09 09351-09
9,5 cm, 3³/₄"



— —
09352-09 09353-09
9,5 cm, 3³/₄"



09360-11



09361-11



09362-11

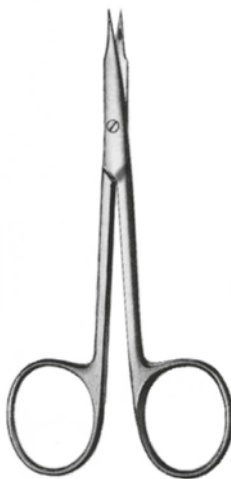

STEVENS
11 cm, 4³/₈"



09363-11

Gefäßscheren
Vascular Scissors
Tijeras vasculares
Forbici vascolari

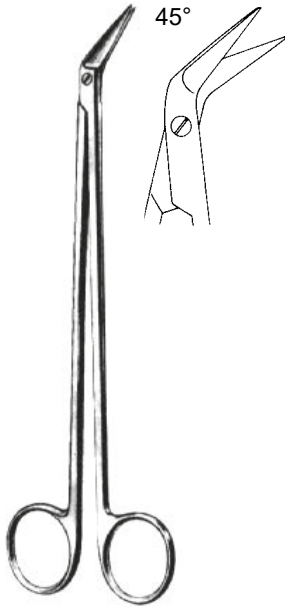

POTTS-DE MARTEL
09473-21
21 cm, 8¼"



MILLS
09474-22
22 cm, 8¾"



DIETRICH



09475-25
09476-25 TC
18 cm, 7"



09475-45
09476-45 TC
18 cm, 7"

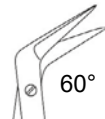

09475-60
09476-60 TC
17,5 cm, 6.9"

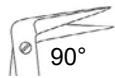

09475-90
09476-90 TC
17 cm, 6¾"



09475-00
09476-00 TC
17 cm, 6¾"

Gefäßscheren
Vascular Scissors
Tijeras vasculares
Forbici vascolari



DIETRICH
09477-01
17 cm, 6¾"

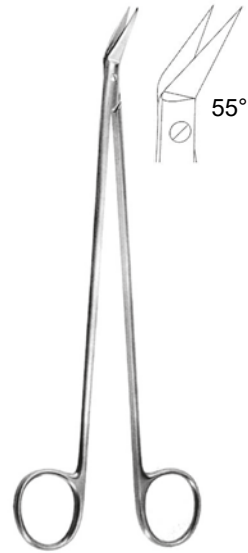

POTTS-SMITH
09480-18
18,5 cm, 7¼"

Scheren mit Hartmetalleinsätzen
Scissors with Tungsten Carbide
Tijeras con carburo de tungsteno
Forbici con carburo di tungsteno

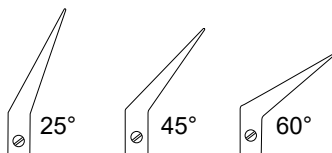

09478-25 09478-45 09478-60
19 cm 19 cm 19 cm
7½" 7½" 7½"

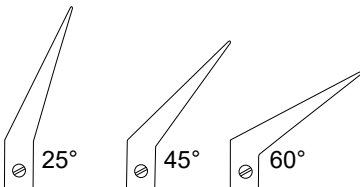

09479-25 09479-45 09479-60
23 cm 23 cm 23 cm
9" 9" 9"



DE BAKHEY
(POTTS-SMITH)

Gefäßscheren
Vascular Scissors
Tijeras vasculares
Forbici vascolari

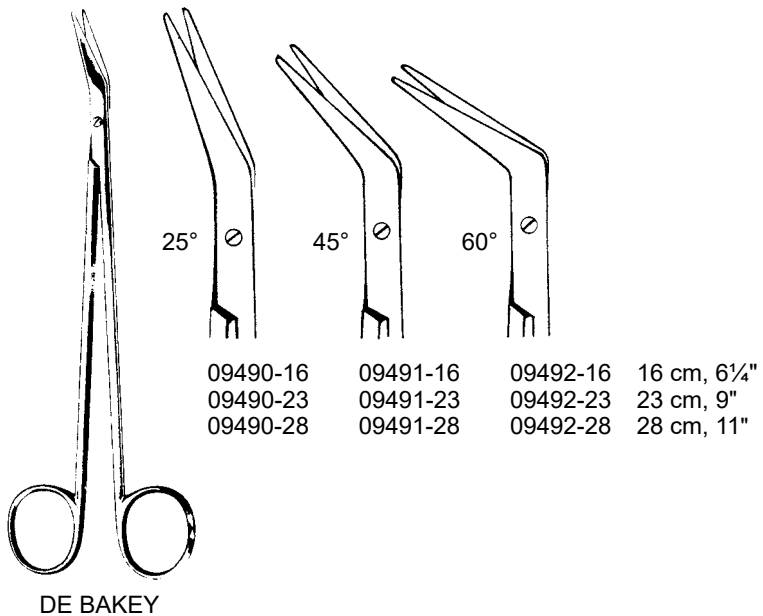
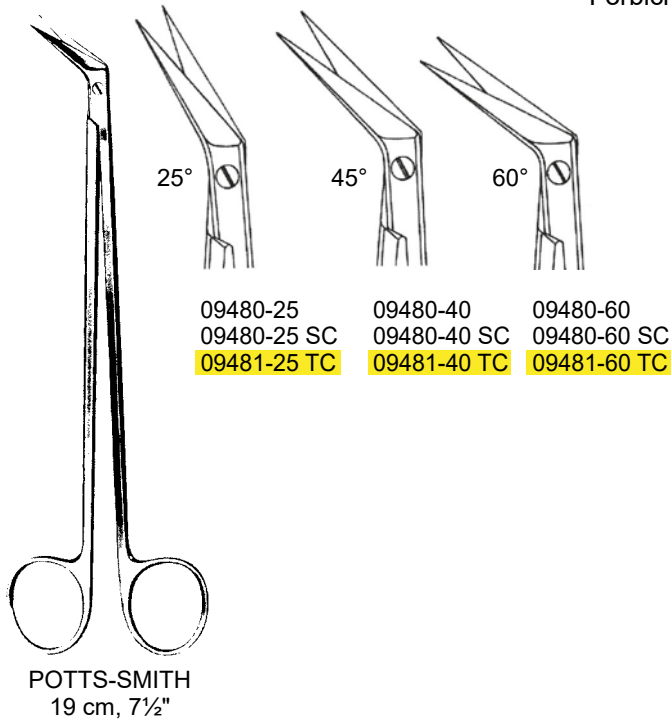

Gefäßscheren
Vascular Scissors
Tijeras vasculares
Forbici vascolari

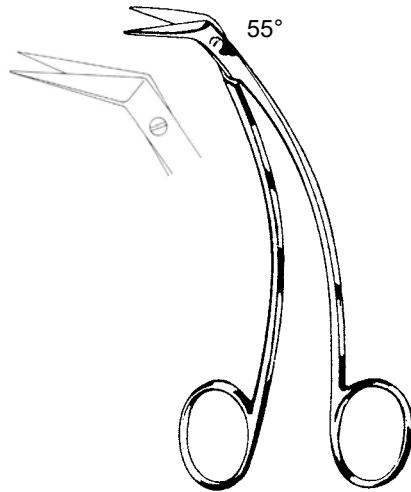

FAVALORO
09496-15 15 cm, 5.9"

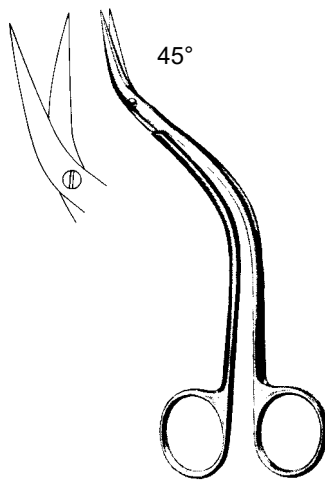

DE BAKEY
09497-15 15,5 cm, 6"

Trigeminusscheren
Trigeminal Scissors
Tijera para trigémino
Forbici per trigemino

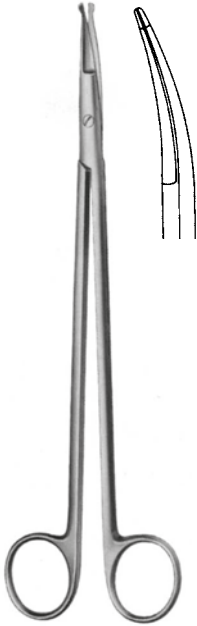

STRULLY
09601-22
22 cm, 8¾"



DANDY
09617-17
17 cm, 6¾"



gezahnt
toothed
dentada
dentate

OLIVECRONA
09620-23
23 cm, 9"

Duraschere
Dura Scissors
Tijeras para duramadre
Forbici per dura-madre



SCHMIEDEN-TAYLOR
09619-17
17 cm, 6¾"

Draht-, Blehschere
Wire and plate scissors
Tijeras para alambre y láminas
Forbici per filo di metallo e lamiera



UNIVERSAL
09831-12 12 cm, 4¾"
09835-12 TC 12 cm, 4¾"

Mikro-Federscheren, bajonettförmig
Micro Scissors (Spring Type), bayonet-shaped
Micro tijeras, forma bayoneta
Micro forbici a baionetta

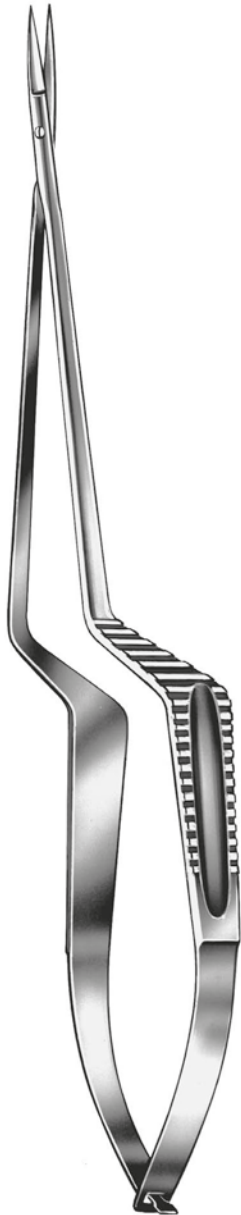

190 mm
7½"



10120-18



10121-18



10122-18



10123-18

Mikro-Federscheren
Micro Scissors (Spring Type)
Micro tijeras
Micro forbici

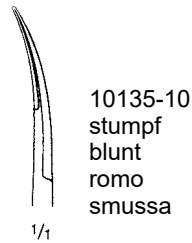
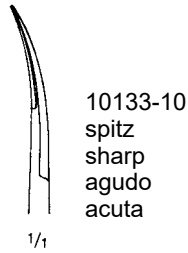

Mikro-Federscheren
Micro Scissors (Spring Type)
Micro tijeras
Micro forbici



10140-08



10141-08



10143-08

Mikro Scheren
 Micro Scissors
 Micro tijeras
 Micro Forbice

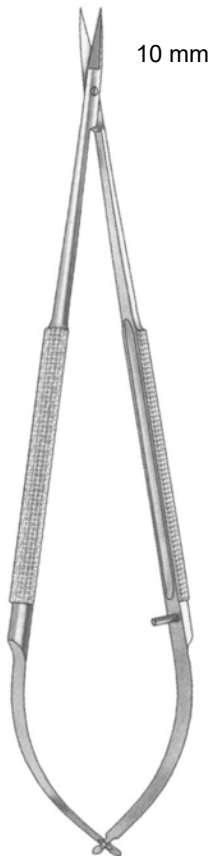

11 cm
 4³/₈"

10202-11

10203-11

14,5 cm
 5³/₄"

10202-14
10202-14T

10203-14
10203-14T

18 cm
 7"

10202-18
10202-18T

10203-18
10203-18T

21 cm
 8¹/₄"

10202-21
10202-21T

10203-21
10203-21T

23 cm
 9"

10202-23

10203-23

T = Titan, titanium, titanio, titanio

Mikro Scheren
Micro Scissors
Micro tijeras
Micro Forbice

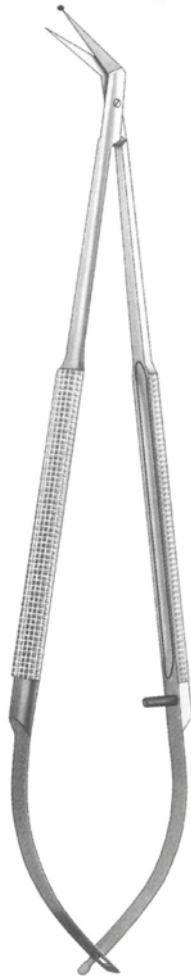

18 cm, 7"



25°

10220-25

10220-25T

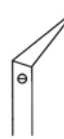

45°

10220-45

10220-45T



60°

10220-60

10220-60T



90°

10220-90

10220-90T



125°





10220-00

10220-00T

T = Titan, titanium, titanio, titanio

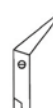
Mikro Scheren
 Micro Scissors
 Micro tijeras
 Micro Forbice



	11 cm 4 ³ / ₈ "	14,5 cm 5 ³ / ₄ "	18 cm 7"	21 cm 8 ¹ / ₄ "	23 cm 9"
 25°	10226-11	10226-14	10226-18 10226-18T	10226-21	10226-23
 45°	10227-11	10227-14	10227-18 10227-18T	10227-21	10227-23
 60°	10228-11	10228-14	10228-18 10228-18T	10228-21	10228-23
 90°	10229-11	10229-14	10229-18 10229-18T	10229-21	10229-23
 125°	10230-11	10230-14	10230-18 10230-18T	10230-21	10230-23

T = Titan, titanium, titanio, titanio

Mikro-Federscheren, bajonettförmig
 Micro Scissors (Spring Type), bayonet-shaped
 Micro tijeras, forma bayoneta
 Micro forbici a baionetta



YASARGIL



93094-16 165 mm / 6½"
 93094-20 200 mm / 8"



93095-16 165 mm / 6½"
 93095-20 200 mm / 8"



93097-20 200 mm / 8"



93098-20 200 mm / 8"
 Präparierscheren
 Dissecting Scissors
 Tijeras de disección
 Forbici per dissezione



93099-20 200 mm / 8"
 Präparierscheren
 Dissecting Scissors
 Tijeras de disección
 Forbici per dissezione

Mikro-Federschere, bajonettförmig
 Micro Scissors (Spring Type), bayonet-shaped
 Micro tijeras, forma bayoneta
 Micro forbici a baionetta



93100-22 225 mm / 9"
 93101-22 225 mm / 9"

YASARGIL
 Schneiden gezahnt
 toothed blades
 ramas dentadas
 tagli dentellati



93102-22 225 mm / 9" VANNAS



93103-22 225 mm / 9"
 93103-24 245 mm / 9¾"

YASARGIL



93105-22 225 mm / 9" VANNAS



93107-22 225 mm / 9" YASARGIL



93108-22 225 mm / 9" YASARGIL
 Präparierscheren
 Dissecting Scissors
 Tijeras de disección
 Forbici per dissezione



93109-22 225 mm / 9" YASARGIL
 Präparierscheren
 Dissecting Scissors
 Tijeras de disección
 Forbici per dissezione

Mikro-Federscheren, bajonettförmig
Micro Scissors (Spring Type), bayonet-shaped
Micro tijeras, forma bayoneta
Micro forbici a baionetta



NAGEL



45°

93111-20 200 mm / 8"



45°

93113-20 200 mm / 8"

mit Kopf
with probe-pointed blade
punta abotonada
punta bottonuta



125°

93115-19 190 mm / 7½"

Mikro-Federscheren
 Micro Scissors (Spring Type)
 Micro tijeras
 Micro forbici



93180-12	120 mm / 4 $\frac{3}{4}$ "	
93180-16	160 mm / 6 $\frac{1}{4}$ "	
93182-16	160 mm / 6 $\frac{1}{4}$ "	MILLES
	Schneiden gezahnt	←
	toothed blades	
	ramas dentadas	
	tagli dentellati	
93180-18	185 mm / 7 $\frac{1}{4}$ "	YASARGIL



93181-12	120 mm / 4 $\frac{3}{4}$ "	
93181-16	160 mm / 6 $\frac{1}{4}$ "	
93183-16	160 mm / 6 $\frac{1}{4}$ "	MILLES
	Schneiden gezahnt	←
	toothed blades	
	ramas dentadas	
	tagli dentellati	
93181-18	185 mm / 7 $\frac{1}{4}$ "	JACOBSON



93190-12	120 mm / 4 $\frac{3}{4}$ "	VANNAS
93190-16	160 mm / 6 $\frac{1}{4}$ "	



93191-12	120 mm / 4 $\frac{3}{4}$ "	VANNAS
93191-16	160 mm / 6 $\frac{1}{4}$ "	

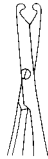

93192-13	130 mm / 5 $\frac{1}{8}$ "	BIEMER
	Venenschere	
	Vein Scissors	
	Tijera para venas	
	Forbice per vene	



93193-12	120 mm / 4 $\frac{3}{4}$ "	VANNAS
----------	----------------------------	--------

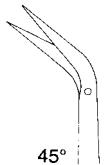

93195-18	185 mm / 7 $\frac{1}{4}$ "	POTTS-YASARGIL
----------	----------------------------	----------------

45°

Mikro-Federscheren
Micro Scissors (Spring Type)
Micro tijeras
Micro forbici

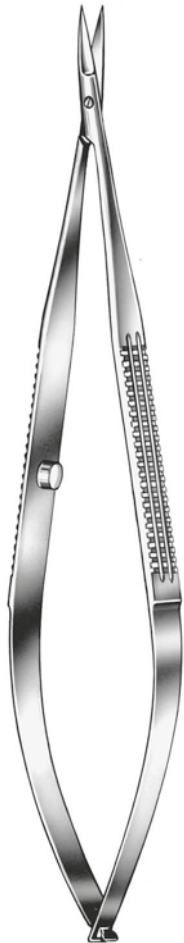

93210-12	120 mm / 4 ³ / ₄ "	
93210-16	160 mm / 6 ¹ / ₄ "	
93212-16	160 mm / 6 ¹ / ₄ "	MILLES
	Schneiden gezahnt	←
	toothed blades	
	ramas dentadas	
	tagli dentellati	
93210-18	185 mm / 7 ¹ / ₄ "	YASARGIL



93211-12	120 mm / 4 ³ / ₄ "	
93211-16	160 mm / 6 ¹ / ₄ "	
93213-16	160 mm / 6 ¹ / ₄ "	MILLES
	Schneiden gezahnt	←
	toothed blades	
	ramas dentadas	
	tagli dentellati	

93211-18	185 mm / 7 ¹ / ₄ "	JACOBSON
----------	--	----------



93216-12	120 mm / 4 ³ / ₄ "	VANNAS
93216-16	160 mm / 6 ¹ / ₄ "	



93217-12	120 mm / 4 ³ / ₄ "	VANNAS
93217-16	160 mm / 6 ¹ / ₄ "	



93218-13	130 mm / 5 ¹ / ₈ "	BIEMER
	Venenschere	
	Vein Scissors	
	Tijera para venas	
	Forbice per vene	



93219-12	120 mm / 4 ³ / ₄ "	VANNAS
----------	--	--------

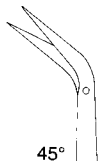

93221-18	185 mm / 7 ¹ / ₄ "	POTTS-YASARGIL
----------	--	----------------

45°

Mikro-Federscheren
 Micro Scissors (Spring Type)
 Micro tijeras
 Micro forbici



93270-14 145 mm / 5¾"
 93270-18 180 mm / 7"



93270-23 230 mm / 9"



93271-14 145 mm / 5¾"
 93271-18 180 mm / 7"

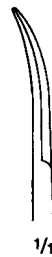

93273-14 145 mm / 5¾"
 93273-18 180 mm / 7"

Mikro Präparierscheren
 Micro dissecting Scissors
 Micro tijeras de disección
 Micro forbici per dissezione

Tumorschere
Tumor scissors
Tijera para tumores
Forbice per tumori

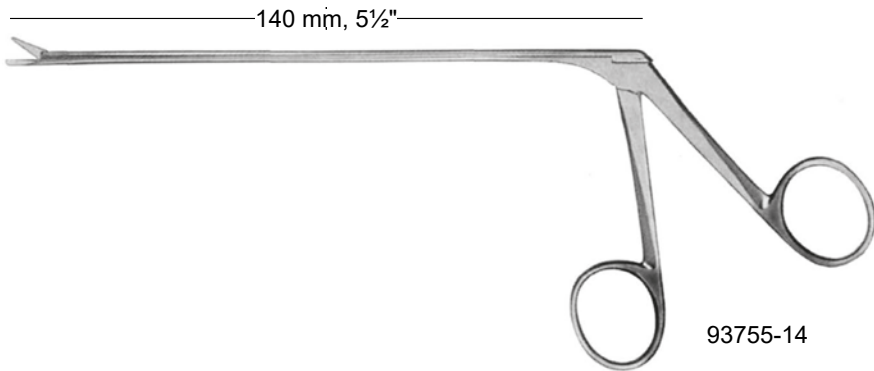

93755-14

gerade
straight
recta
retta



93756-14

rechts gebogen
curved right
curva hacia la derecha
curva a destra



93757-14

links gebogen
curved left
curva hacia la izquierda
curva a sinistra



Rippenscheren
Rib Shears
Costótomos
Costotomi



SAUERBRUCH
57131-26
26 cm, 10¼"

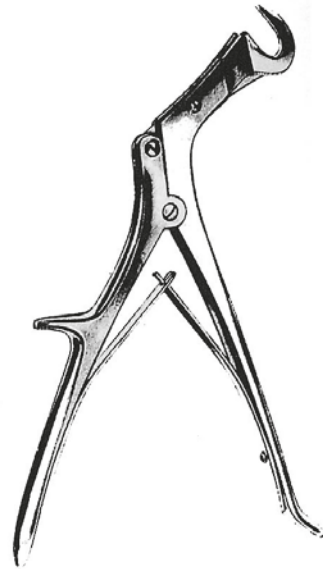

GIERTZ-STILLE
57137-27
27 cm, 10½"



SAUERBRUCH-FREY
57141-36
36 cm, 14.2"

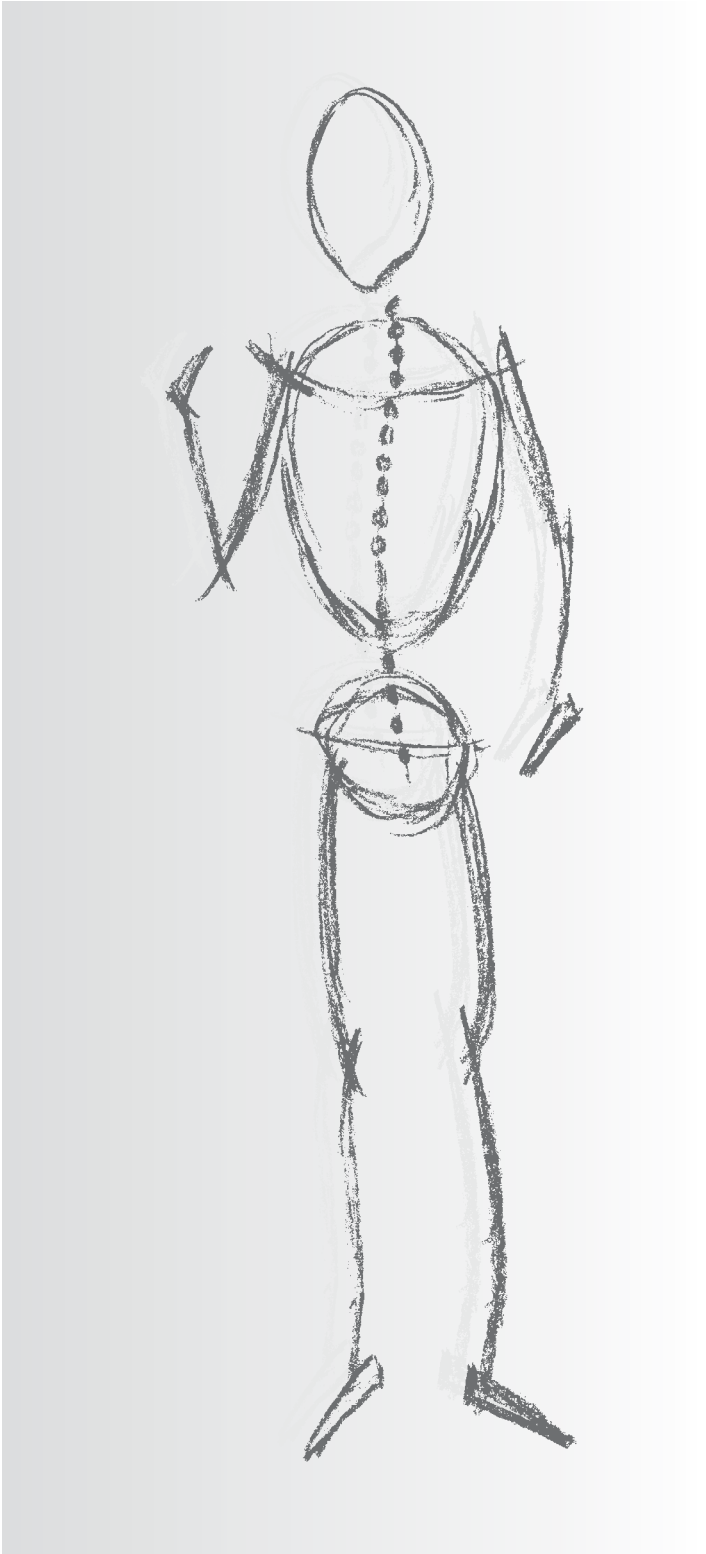

Reda Instrumente GmbH
Gänsäcker 34 - P.O. Box 131
D-78532 Tuttlingen

PINZETTEN

FORCEPS

PINZAS

PINZETTE

Anatomische und chirurgische Pinzetten
 Dressing and Tissue Forceps
 Pinzas de disección, sin/con dientes
 Pinze per dissezione, chirurgiche/anatomiche



POTTS-SMITH

- | | | |
|----------|------------|-------------|
| 11112-18 | 18 cm, 7" | 11116-18 TC |
| 11112-21 | 21 cm, 8¼" | 11116-21 TC |
| 11112-25 | 25 cm, 10" | 11116-25 TC |



1x2

POTTS-SMITH

- | | |
|----------|------------|
| 11126-18 | 18 cm, 7" |
| 11126-21 | 21 cm, 8¼" |
| 11126-25 | 25 cm, 10" |

Anatomische und chirurgische Pinzetten
 Dressing and Tissue Forceps
 Pinzas de disección, sin/con dientes
 Pinze per dissezione, chirurgiche/anatomiche



ADSON
 11170-12 12,0 cm, 4¾"
 11170-15 15,0 cm, 6"



ADSON
 11174-12 TC 12,0 cm, 4¾"
 11174-15 TC 15,0 cm, 6"



ADSON micro
 11176-12 12,0 cm, 4¾"
 11176-15 15,0 cm, 6"

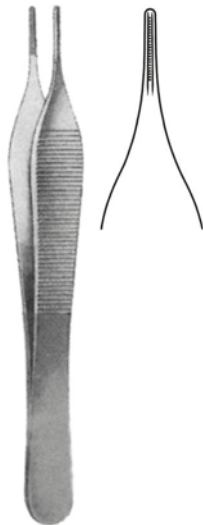

ADSON-DE BAKEY Atrauma
 11177-12
 12,0 cm, 4¾"

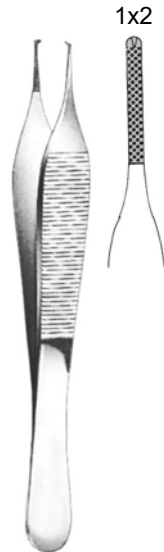

ADSON
 11178-12
 12,0 cm, 4¾"



ADSON
 11179-12
 12 cm, 4¾"

Anatomische und chirurgische Pinzetten
 Dressing and Tissue Forceps
 Pinzas de disección, sin/con dientes
 Pinze per dissezione, chirurgiche/anatomiche



ADSON
 11180-12 12,0 cm, 4¾"
 11180-15 15,0 cm, 6"

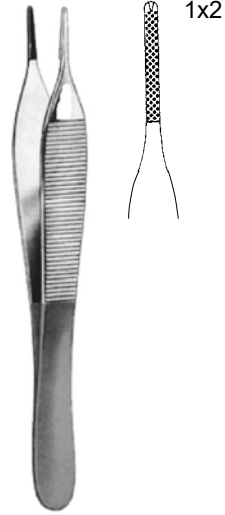

ADSON
 11181-12 TC 12,0 cm, 4¾"
 11181-15 TC 15,0 cm, 6"



ADSON micro
 11186-12 12,0 cm, 4¾"
 11186-15 15,0 cm, 6"



ADSON
 11187-12
 12 cm, 4¾"



ADSON-BROWN
 11188-12 12,0 cm, 4¾"
 11188-15 15,0 cm, 6"
 11189-12 TC 12,0 cm, 4¾"

Anatomische und chirurgische Pinzetten
 Dressing and Tissue Forceps
 Pinzas de disección, sin/con dientes
 Pinze per dissezione, chirurgiche/anatomiche



9x9

BROWN

- 11189-15 15,0 cm, 6"
- 11189-20 20,0 cm, 8"
- 11189-25 25,0 cm, 10"



1x2

WAUGH

- 11187-18 18 cm, 7"
- 11187-20 20 cm, 8"
- 11187-25 25 cm, 10"
- 11187-30 30 cm, 11¾"



11220-17
 11224-17 TC



11221-17

CUSHING
 17 cm, 6¾"



11222-17
 11225-17 TC

1x2



11223-17

CUSHING
 17 cm, 6¾"

Anatomische und chirurgische Pinzetten
 Dressing and Tissue Forceps
 Pinzas de disección, sin/con dientes
 Pinze per dissezione, chirurgiche/anatomiche



BROPHY
 11231-20
 20,0 cm, 8"



BROPHY
 11233-20
 20,0 cm, 8"



11234-20



11235-20



BROPHY
 20,0 cm, 8"



ADLERKREUTZ
 11236-15 15,0 cm, 6"
 11236-20 20,0 cm, 8"

Anatomische und chirurgische Pinzetten
Dressing and Tissue Forceps
Pinzas de disección, sin/con dientes
Pinze per dissezione, chirurgiche/anatomiche



DUEHRSEN
11237-20
20 cm, 8"

1x2



McINDOE
11257-15
15,0 cm, 6"



McINDOE
11258-15 15,0 cm, 6"
11259-15 TC 15,0 cm, 6"

Anatomische und chirurgische Pinzetten
 Dressing and Tissue Forceps
 Pinzas de disección, sin/con dientes
 Pinze per dissezione, chirurgiche/anatomiche



SEMKEN
 11260-12 12,5 cm, 5"
 11260-15 15,5 cm, 6"
 11261-15 TC 15,5 cm, 6"



1x2

SEMKEN
 11270-12 12,5 cm, 5"
 11270-15 15,5 cm, 6"
 11271-15 TC 15,5 cm, 6"
 11271-18 TC 18,0 cm, 7"



1x2

GILLIES
 11272-15 15,5 cm, 6"
 11273-15 TC 15,5 cm, 6"



15,5 cm, 6"



11274-06
 0,6 mm

11274-08
 0,8 mm

11274-10
 1,0 mm



GERALD
 11302-17 17,5 cm, 6.9"
 11302-23 23,0 cm, 9"
 11304-17 TC 17,0 cm, 6¾"



GERALD
 11303-17
 17,5 cm, 6.9"

Anatomische und chirurgische Pinzetten
 Dressing and Tissue Forceps
 Pinzas de disección, sin/con dientes
 Pinze per dissezione, chirurgiche/anatomiche



GERALD
 11305-17
 17,5 cm, 6.9"



GERALD
 11310-17 17,5 cm, 6.9"
 11312-17 TC 17,5 cm, 6.9"

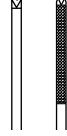

1x2



GERALD
 11311-17
 17,5 cm, 6.9"

1x2



CUSHING-TAYLOR
 11312-18 TC 18,5 cm, 7 1/4"



GERALD
 11313-17 17,5 cm, 6.9"

1x2

Anatomische und chirurgische Pinzetten
 Dressing and Tissue Forceps
 Pinzas de disección, sin/con dientes
 Pinze per dissezione, chirurgiche/anatomiche

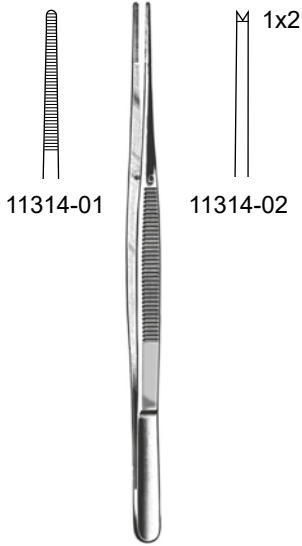

TAYLOR
 17 cm, 6¾"

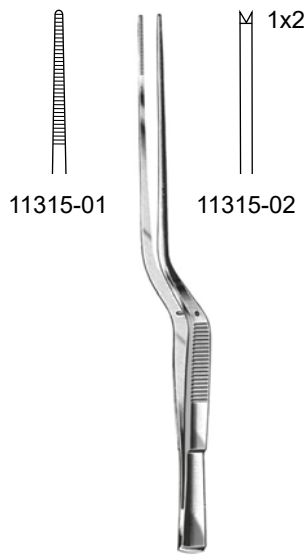

TAYLOR
 17 cm, 6¾"



WANGENSTEEN
 11324-23 23 cm, 9"



WANGENSTEEN
 11325-15 TC 15 cm, 6"
 11325-23 TC 23 cm, 9"
 11325-25 TC 25 cm, 10"



MAYO
 11326-23 23 cm, 9"

Uhrmacherpinzette
Jeweler Type Forceps
Pinzas de relojero
Pinze da orologiaio

Fig. 1



11401-01
12 cm, 4³/₄"

Fig. 3



11403-03
12 cm, 4³/₄"

Fig. 3c



11403-04
11 cm, 4³/₈"

Fig. 4



11404-04
11 cm, 4³/₈"

Fig. 5



11405-05
11 cm, 4³/₈"

Fig. 7



11407-07
12 cm, 4³/₄"

Gefäßdilatoren
 Vessel dilators
 Dilatadores vasculares
 Pinze dilatatori vascolari



0,2 mm

0,3 mm

0,2 mm

0,3 mm



11408-01
 11 cm, 4³/₈"

11408-02
 11 cm, 4³/₈"

11408-03
 13,5 cm, 5¹/₄"

11408-04
 13,5 cm, 5¹/₄"

Juwelierpinzette/Uhrmacherpinzette
 Jeweler's Forceps/Jeweler Type Forceps
 Pinzas para joyero/Pinzas de relojero
 Pinze per gioielliere/Pinze da orologiaio

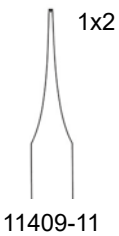

11,5 cm, 4¹/₂"



0,3 mm



11 cm, 4³/₈"



Mikro Knüpppinzetten
 Micro Suture Tying Forceps
 Micro Pinzas para ligaduras
 Micro Pinze per legature



	0,3 mm	0,8 mm
12 cm, 4¾"	12102-12	
	12102-12D	
15 cm, 6"	12104-15	
	12104-15D	
18 cm, 7"		12108-18
		12108-18D
21 cm, 8¼"		12102-21
		12102-21D
23 cm, 9"		12102-23
		12102-23D



	0,3 mm	0,8 mm
12 cm, 4¾"	12103-12	
	12103-12D	
15 cm, 6"	12103-15	
	12103-15D	
18 cm, 7"		12109-18
		12109-18D
21 cm, 8¼"		12109-21
		12109-21D
23 cm, 9"		12109-23
		12109-23D

1x2



	0,3 mm	0,3 mm
15 cm, 6"	12090-15D	12091-15D
	0,4 mm	0,4 mm
18 cm, 7"	12090-18D	12091-18D
	0,8 mm	0,8 mm
21 cm, 8¼"	12090-21D	12091-21D
23 cm, 9"	12090-23D	12091-23D

1x2



D = mit diamantiertem Maul
 with diamond jaw
 con boca de diamante
 con morso diamantato

Mikro Knüpfpinzetten
Micro Suture Tying Forceps
Micro Pinzas para ligaduras
Micro Pinze per legature



LAZAR



93340-15 155 mm / 6"
Spitzen 0,5 mm
tips 0,5 mm
puntas de 0,5 mm
punte 0,5 mm



93342-15 155 mm / 6"
Spitzen 0,8 mm
tips 0,8 mm
puntas de 0,8 mm
punte 0,8 mm



93342-18 185 mm / 7¼"
Spitzen 0,5 mm
tips 0,5 mm
puntas de 0,5 mm
punte 0,5 mm

Mikro Knüpfpinzetten
 Micro Suture Tying Forceps
 Micro Pinzas para ligaduras
 Micro Pinze per legature



WISE

0,3 mm

93350-12
 120 mm / 4¾"



0,3 mm

93350-13
 135 mm / 5¼"



0,3 mm

93351-13
 135 mm / 5¼"



1x2



93360-09
 95 mm
 3¾"

0,2 mm

93360-09
 95 mm / 3¾"



0,8 mm

93370-14
 140 mm / 5½"



93370-18
 180 mm / 7" AUSTIN

Ultra-Light-Pinzetten
Ultra-Light-Forceps
Pinzas-Ultra-Ligeras
Pinza-Ultra-Leggera

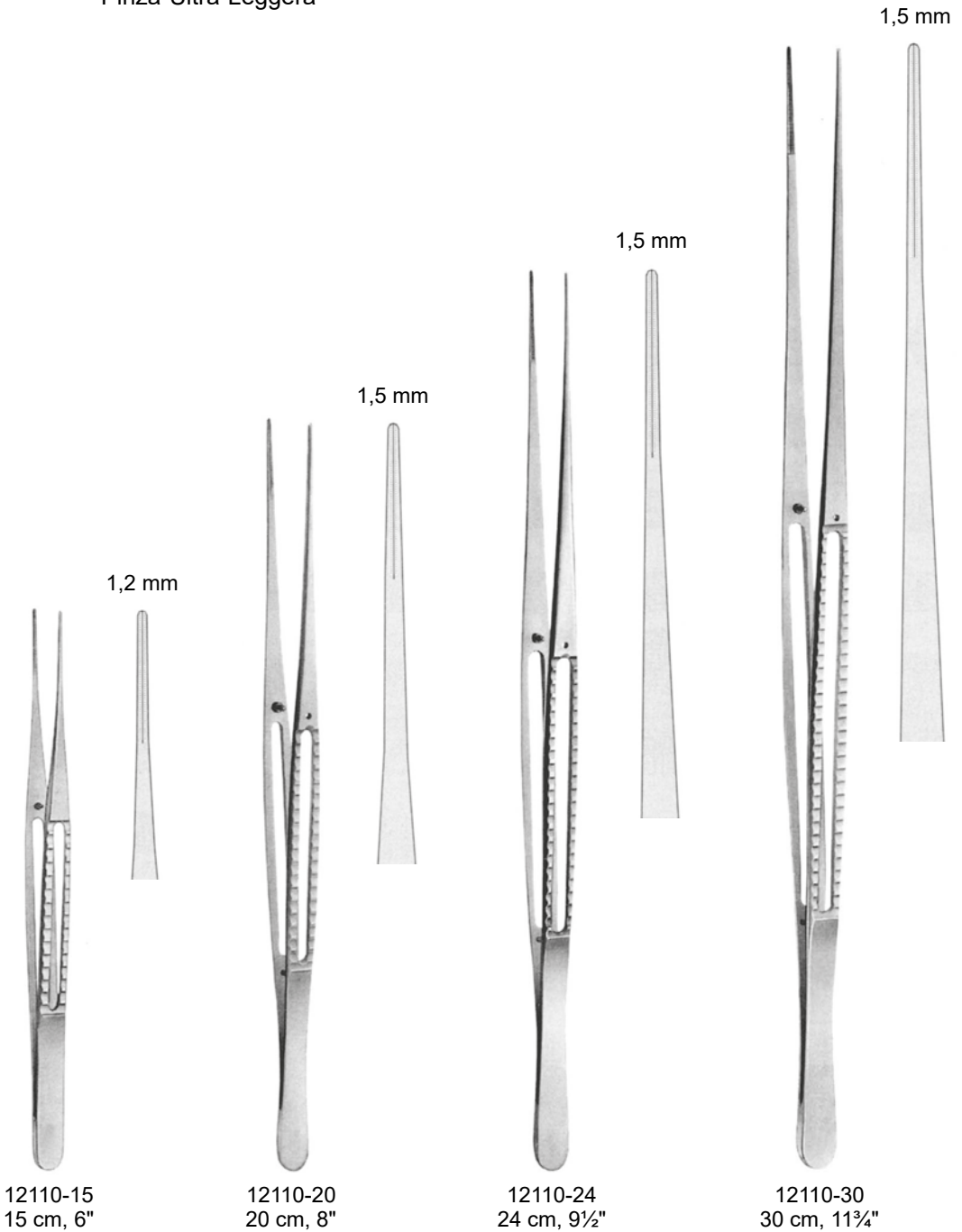

Mikro Ring Pinzetten
 Micro Ring Forceps
 Micro Pinzas
 Micro Pinza

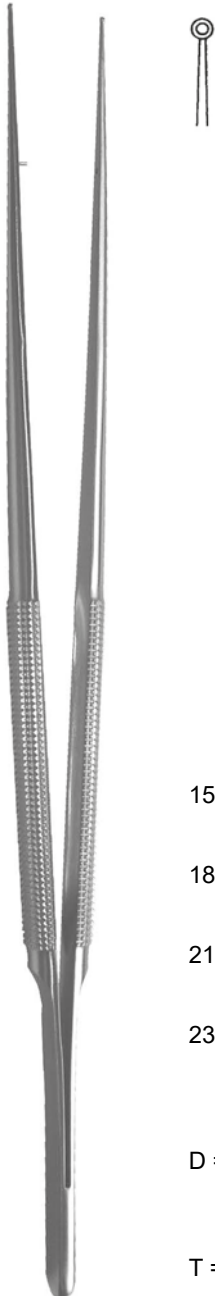

	Ø 1 mm x 0,5 mm	Ø 2 mm x 1 mm
15 cm, 6"	12112-15D 12112-15T	12114-15D 12114-15T
18 cm, 7"	12112-18D 12112-18T	12114-18D 12114-18T
21 cm, 8¼"	12112-21D 12112-21T	12114-21D 12114-21T
23 cm, 9"	12112-23D 12112-23T	12114-23D 12114-23T

D = mit diamantiertem Maul
 with diamond jaw
 con boca de diamante
 con morso diamantato

T = Titan, titanium, titanio, titanio

Atrauma Mikro Pinzetten
 Atrauma Micro Forceps
 Micro Pinzas Atraumáticas
 Micro Pinza Atraumatica



	1,2 mm	2,0 mm
15 cm, 6"	12115-15 12115-15T	12116-15
18 cm, 7"	12115-18 12115-18T	12116-18
21 cm, 8¼"	12115-21 12115-21T	12116-21
23 cm, 9"	12115-23 12115-23T	12116-23

T = Titan, titanium, titanio, titanio

DE BAKEY

TC Atrauma Pinzetten
TC Atrauma Forceps
Pinzas Atraumáticas con TC
Pinza Atraumatica TC



	1,2 mm	2,0 mm
18 cm, 7"	12117-18 TC	12118-18 TC
21 cm, 8¼"	12117-21 TC	12118-21 TC
23 cm, 9"	12117-23 TC	12118-23 TC

DE BAKEY TC

Atraumatische Pinzetten
 Atraumatic Tissue Forceps
 Pinzas Atraumáticas
 Pinze Atraumatiche



1 mm

DE BAKEY
 12302-16 16 cm, 6¼"
 12302-20 20 cm, 8"
 12302-24 24 cm, 9½"



1,5 mm

DE BAKEY
 12306-16 16 cm, 6¼"
 12306-20 20 cm, 8"
 12306-24 24 cm, 9½"
 12306-30 30 cm, 11¼"



2,0 mm

DE BAKEY
 12308-16 16 cm, 6¼"
 12308-20 20 cm, 8"
 12308-24 24 cm, 9½"
 12308-30 30 cm, 11¼"

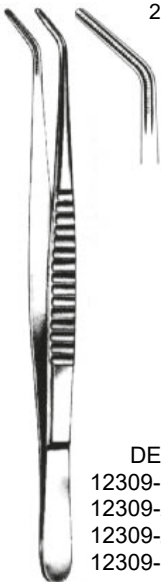

2,0 mm

DE BAKEY
 12309-16 16 cm, 6¼"
 12309-20 20 cm, 8"
 12309-24 24 cm, 9½"
 12309-30 30 cm, 11¼"



2,7 mm

DE BAKEY
 12304-16 16 cm, 6¼"
 12304-20 20 cm, 8"
 12304-24 24 cm, 9½"
 12304-30 30 cm, 11¼"



3,5 mm

DE BAKEY
 12310-16 16 cm, 6¼"
 12310-20 20 cm, 8"
 12310-24 24 cm, 9½"
 12310-30 30 cm, 11¼"

Pinzetten zum Fassen von Gewebe, Tumoren
 Forceps for grasping tissue, tumors
 Pinzas para coger tejidos y tumores
 Pinze per afferrare tessuti e tumori

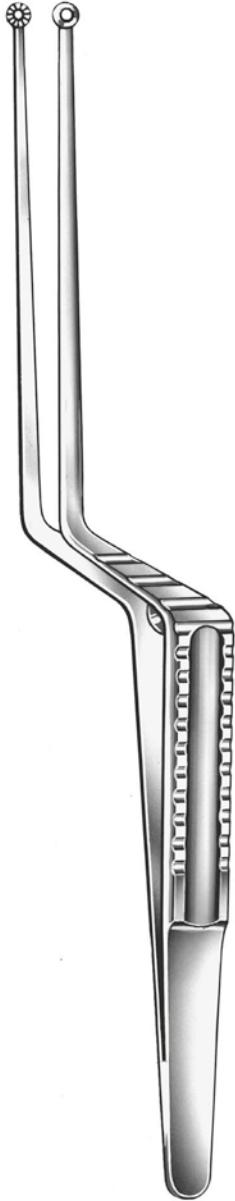

Ø 3 mm

12295-22 200 mm / 8" YASARGIL

Maul flach, gezahnt
 flat jaw, serrated
 boca plana, dentada
 morso piatto, striato



Ø 5 mm

12297-22 200 mm / 8" HUNT

Maul flach, gezahnt
 flat jaw, serrated
 boca plana, dentada
 morso piatto, striato



12300-18 185 mm / 7¼"

feine Spitzen
 fine tips
 puntas finas
 punte acute



12302-18 185 mm / 7¼"

breite Spitzen
 broad tips
 puntas anchas
 punte smusse



12303-18 185 mm / 7¼"

breite Spitzen
 broad tips
 puntas anchas
 punte smusse

Pinzetten zum Fassen von Gewebe, Tumoren
Forceps for grasping tissue, tumors
Pinzas para coger tejidos y tumores
Pinze per afferrare tessuti e tumori

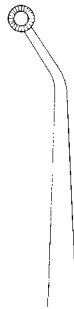

Ø 5 mm

Maul flach, gezahnt
flat jaw, serrated
boca plana, dentada
morso piatto, striato

HUNT
12305-20
200 mm
8"

Pinzetten zum Fassen von Gewebe, Tumoren
 Forceps for grasping tissue, tumors
 Pinzas para coger tejidos y tumores
 Pinze per afferrare tessuti e tumori



	93300-22 220 mm / 8¾" YASARGIL Ø 3 mm 93300-24 240 mm / 9½" YASARGIL-SAMII	
	Maul löffelförmig jaw spoon-shaped boca en forma de cucharilla morso forma cucchiaio liscio	
		93302-22 220 mm / 8¾" YASARGIL Ø 5 mm 93302-24 240 mm / 9½" YASARGIL-SAMII
		Maul löffelförmig jaw spoon-shaped boca en forma de cucharilla morso forma cucchiaio liscio
		93304-24 240 mm / 9½" YASARGIL-SAMII
		Maul löffelförmig jaw spoon-shaped boca en forma de cucharilla morso forma cucchiaio liscio
		93306-22 220 mm / 8¾" YASARGIL
		Maul flach, gezahnt flat jaw, serrated boca plana, dentada morso piatto, striato
	93308-22 220 mm / 8¾" YASARGIL	
	Maul flach, gezahnt flat jaw, serrated boca plana, dentada morso piatto, striato	
	93310-22 220 mm / 8¾" HEIFETZ	
	Maul kürettenförmig curette jaw, toothed boca en forma de cureta, estriada morso forma curetta, striato	
	93312-22 220 mm / 8¾" HEIFETZ	
	Maul kürettenförmig curette jaw, toothed boca en forma de cureta, estriada morso forma curetta, striato	

Pinzetten zum Fassen von Gewebe, Tumoren
Forceps for grasping tissue, tumors
Pinzas para coger tejidos y tumores
Pinze per afferrare tessuti e tumori

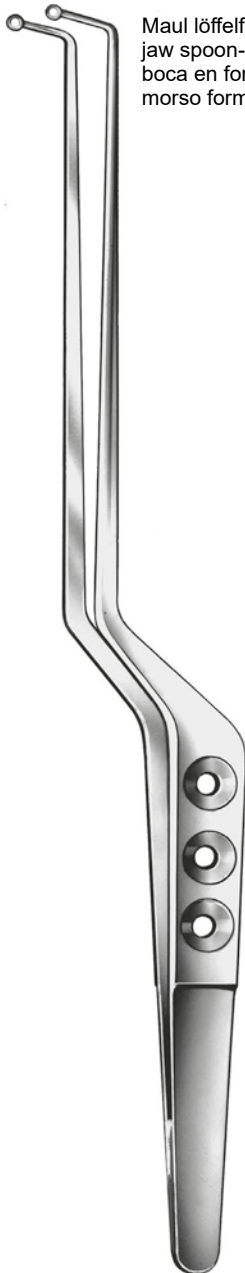

Maul löffelförmig
jaw spoon-shaped
boca en forma de cucharilla
morso forma cucchiaino liscio

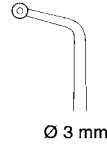

93321-23

Ø 3 mm

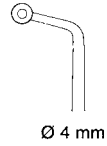

93323-23

Ø 4 mm



93325-23

Ø 5 mm



93327-23

Ø 3 mm



93329-23

Ø 4 mm

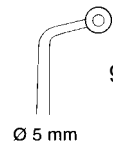

93331-23

Ø 5 mm

SAMII
230 mm, 9"

Pinzette, bajonettförmig
 Forceps, bayonet-shaped
 Pinzas, forma bayoneta
 Pinze, forma di baionetta



LUCAE
 45206-14 14 cm, 5½"



LUCAE
 45206-16 16 cm, 6¼"



COTTLE
 45208-14 14 cm, 5½"



JANSEN-GRUENWALD
 47154-20 20 cm, 8"



JANSEN
 47155-20 20 cm, 8"

Mikro Pinzetten, bajonettförmig
 Micro Forceps, bayonet-shaped
 Micro Pinzas, forma bayoneta
 Micro Pinze, forma di baionetta



YASARGIL



- 93290-16 160 mm / 6¼"
- 93290-18 180 mm / 7"
- 93290-20 200 mm / 8"
- 93290-22 220 mm / 8¾"
- 93290-24 240 mm / 9½"

Spitzen 0,6 mm
 tips 0,6 mm
 puntas de 0,6 mm
 punte 0,6 mm



- 93292-16 160 mm / 6¼"
- 93292-18 180 mm / 7"
- 93292-20 200 mm / 8"
- 93292-22 220 mm / 8¾"
- 93292-24 240 mm / 9½"

Spitzen 0,9 mm
 tips 0,9 mm
 puntas de 0,9 mm
 punte 0,9 mm

1.5 mm



- 93294-18 180 mm / 7"

1 x 2 Zähne
 1 x 2 teeth
 1 x 2 dientes
 1 x 2 denti

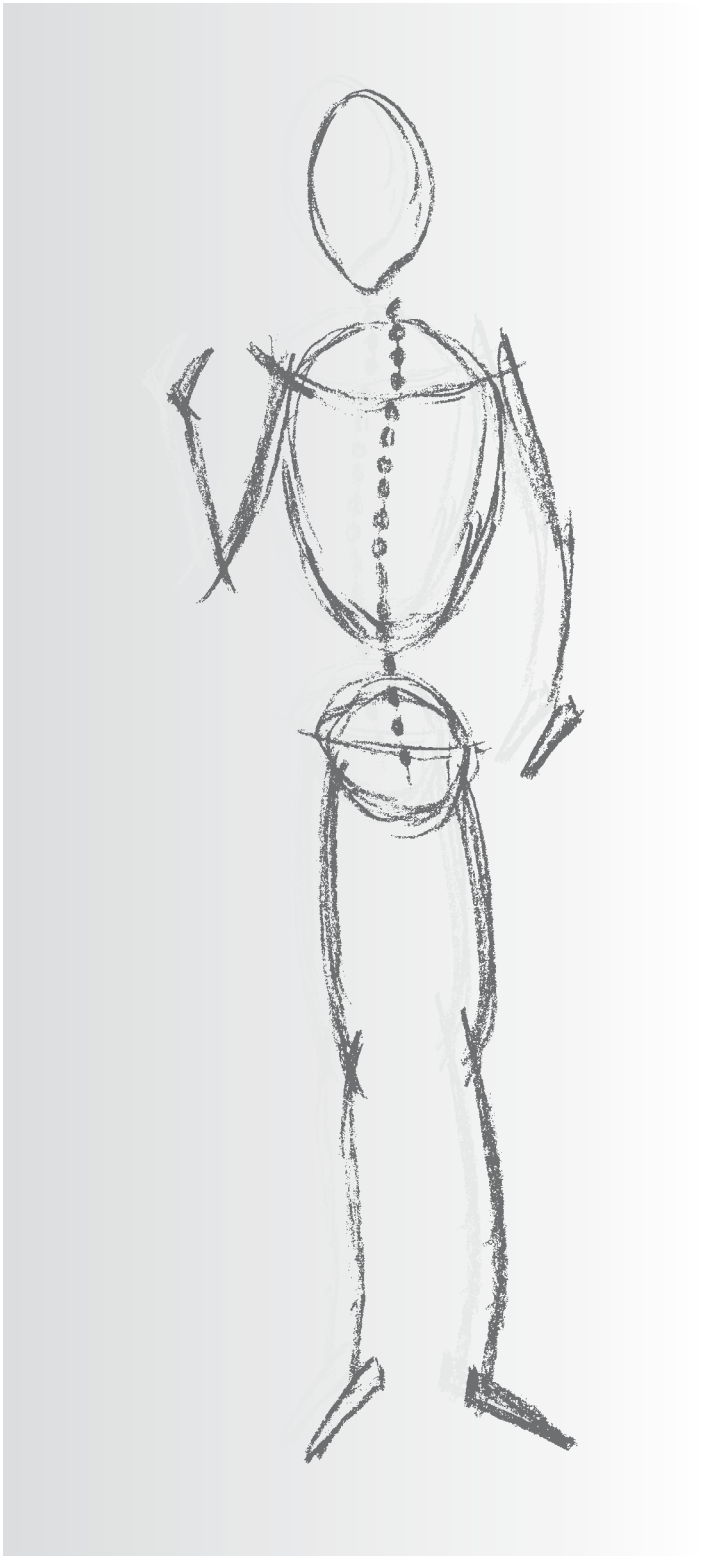

Reda Instrumente GmbH
Gänsäcker 34 - P.O. Box 131
D-78532 Tuttlingen

KLEMMEN

CLAMPS

PINZAS

PINZE

Mini-Bulldogklemmen
Mini Bulldog Clamps
Clamps Bulldog Mini
Pinze Bulldog Mini

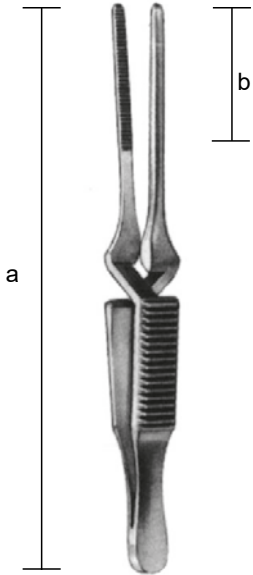

DIETHRICH

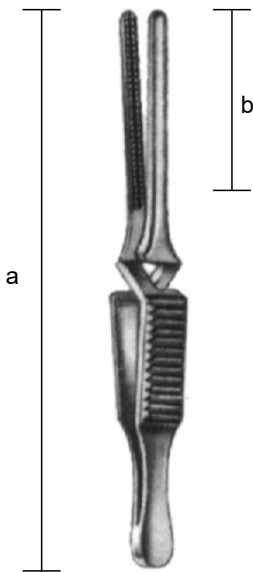
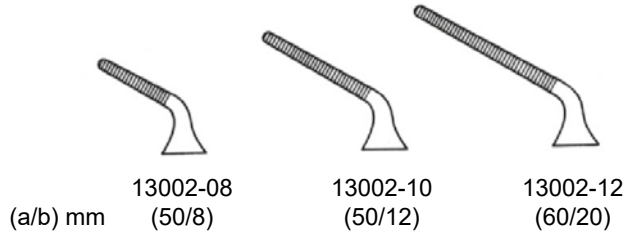
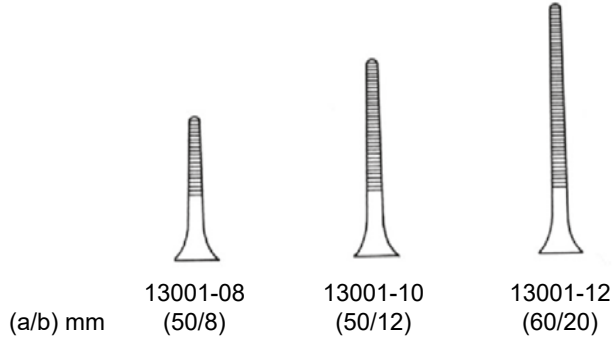

DE BAKEY-DIETHRICH

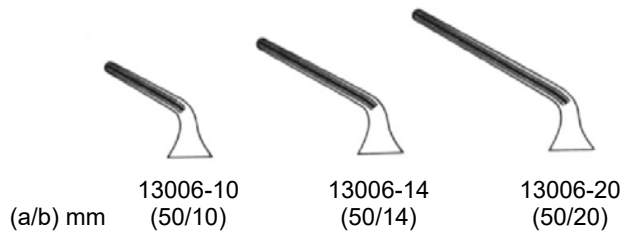
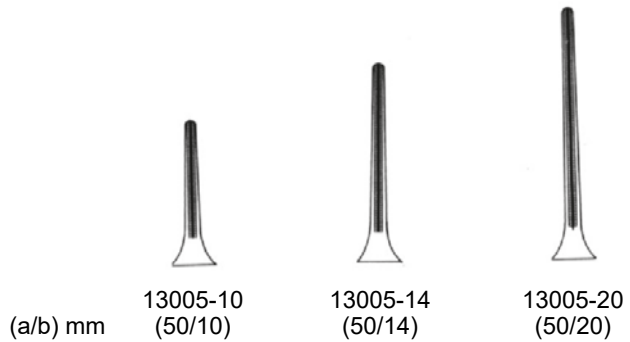

Titan-Atrauma-Bulldogklemmen
 Titanium Atrauma Bulldog Clamps
 Titan Clamps Atrauma Bulldog
 Titan Pinze Atrauma Bulldog

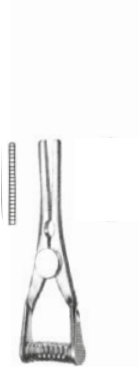

3 cm, 1.2"

Vene **13010-30**
 Arterie **13011-30**

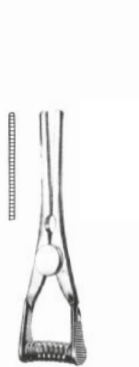

3,5 cm, 1.4"

13010-35
13011-35

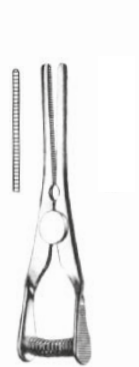

4 cm, 1½"

13010-40
13011-40



5 cm, 2"

13010-50
13011-50



3 cm, 1.2"

Vena **13012-30**
 Arteria **13013-30**



3,5 cm, 1.4"

13012-35
13013-35

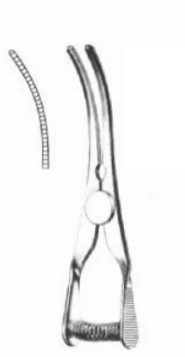

4 cm, 1½"

13012-40
13013-40

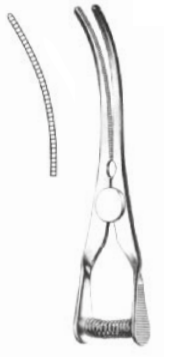

5 cm, 2"

13012-50
13013-50

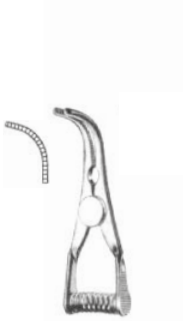

3 cm, 1.2"

Vene **13014-30**
 Arterie **13015-30**



3,5 cm, 1.4"

13014-35
13015-35



4 cm, 1½"

13014-40
13015-40

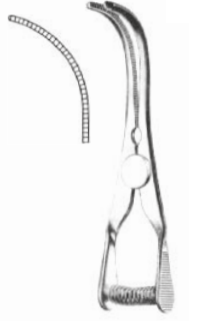

5 cm, 2"

13014-50
13015-50

Atrauma-Bulldogklemmen
Atrauma-Bulldog Clamps
Clamps Atrauma Bulldog
Pinze Atrauma Bulldog



13090-40
40 mm / 1½"

13090-45
45 mm / 1¾"

13090-50
50 mm / 2"



13091-40
40 mm / 1½"

13091-45
45 mm / 1¾"

13091-50
50 mm / 2"

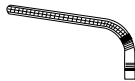

GLOVER
13098-06
57 mm
2⅜"



DE BAKEY
13099-07
73 mm
2¾"

Atrauma-Bulldogklemmen
 Atrauma Bulldog Clamps
 Clamps Atrauma Bulldog
 Pinze Atrauma Bulldog



DE BAKEY

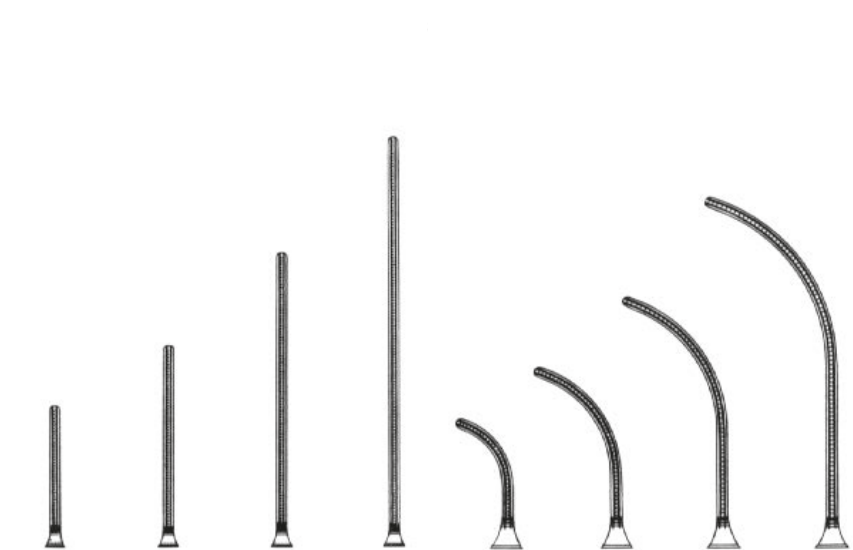

13092-07	13092-08	13092-10	13092-12	13093-07	13093-08	13093-10	13093-12
7,5 cm	8,5 cm	10,5 cm	12 cm	7 cm	8 cm	10 cm	11,5 cm
3"	3.4"	4"	4¾"	2¾"	8⅝"	4"	4½"

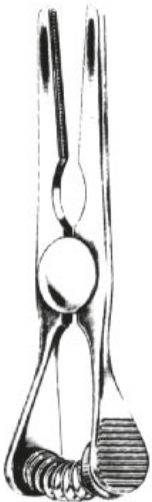

GLOVER



13096-06	13096-07	13096-09	13096-11	13097-06	13097-07	13097-09	13097-11
6 cm	7 cm	9 cm	11 cm	5,5 cm	6,5 cm	8,5 cm	10,5 cm
2¼"	2¾"	3½"	4¾"	2"	2½"	3¼"	4"

Atrauma-Bulldogklemmen
Atrauma-Bulldog Clamps
Clamps Atrauma Bulldog
Pinze Atrauma Bulldog

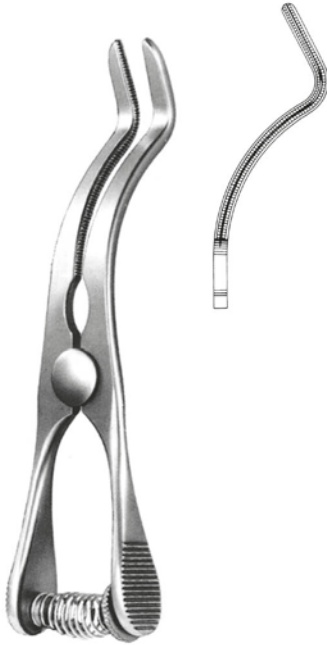

DE BAKEY
13094-09
9 cm, 3½"

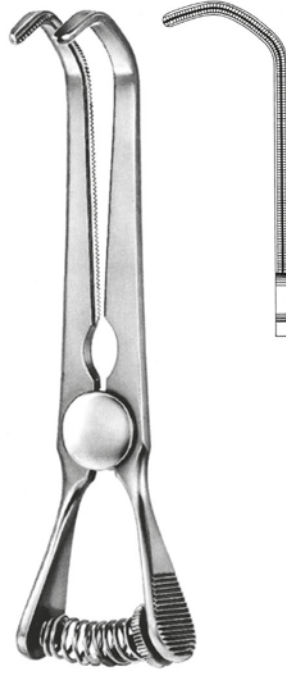

DE BAKEY
13095-10
10 cm, 4"



3 cm, 1.2"

Mauillänge
Jaw length
Largo de la boca
Lunghezza del morso

DE BAKEY-HESS
13113-03

Gefäßklemmen, Bulldogklemmen, Arterienklemmen
 Bulldog Clamps, Hemostatic Forceps
 Pinzas serra-finas, Pinzas hemostáticas
 Pinze serrafina, Pinze emostatiche



DIEFFENBACH
 13102-04 3,5 cm, 1.4"
 13102-05 5,5 cm, 2.2"



gerade
 straight
 recta
 rette

gebogen
 curved
 curva
 curve

JOHNS-HOPKINS

13110-50	5,0 cm, 2"	13111-50
13110-55	5,5 cm, 2.2"	13111-55
13110-65	6,5 cm, 2.6"	13111-65
13110-70	7,0 cm, 2¾"	13111-70
13110-75	7,5 cm, 3"	13111-75
13110-90	9,0 cm, 3½"	13111-90



DIEFFENBACH
 13103-04 3,5 cm, 1.4"
 13103-05 5,5 cm, 2.2"

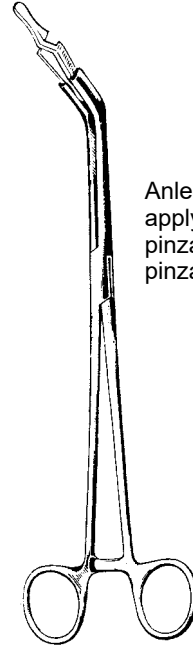

Anlegezange
 applying Forceps
 pinza aplicadora
 pinza applicatrice

13115-00
 23 cm, 9"

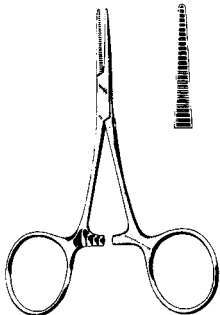

HARTMANN
 13210-10
 10 cm, 4"

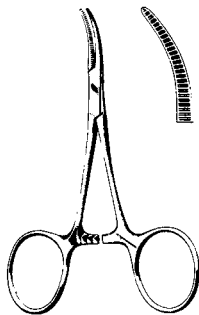

HARTMANN
 13211-10
 10 cm, 4"

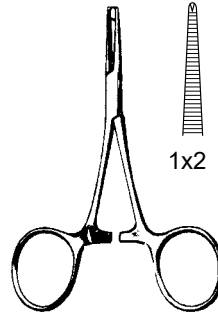

HARTMANN
 13212-10
 10 cm, 4"

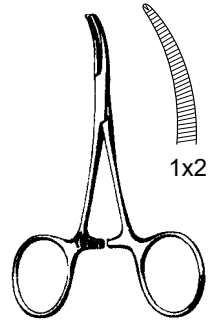

HARTMANN
 13213-10
 10 cm, 4"

Micro-HARTMANN
 13214-10
 10 cm, 4"

Micro-HARTMANN
 13215-10
 10 cm, 4"

Arterienklemmen
 Hemostatic Forceps
 Pinzas hemostáticas
 Pinze emostatiche

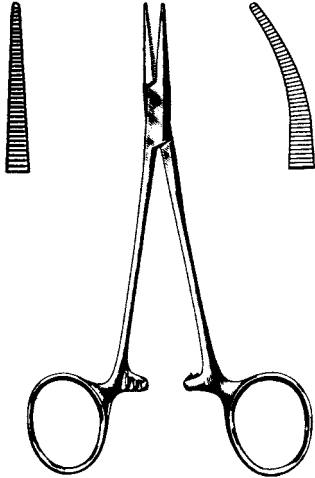

HALSTED-MOSQUITO

TITAN

13224-12

13220-12 12,5 cm, 5"

13220-14 14,0 cm, 5½"

13220-18 18,0 cm, 7"

TITAN

13225-12

13221-12

13221-14

13221-18

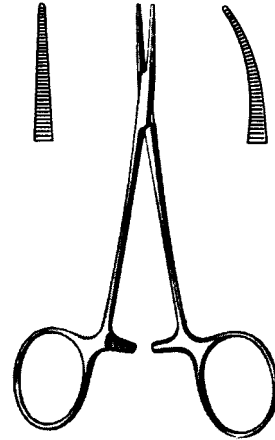

HALSTED-MOSQUITO micro

13222-12 12,5 cm, 5" 13223-12

JACOBSON micro

13226-12 12,5 cm, 5" 13227-12

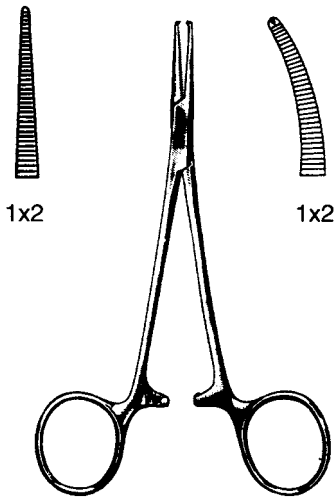

HALSTED-MOSQUITO

13230-12 12,5 cm, 5" 13231-12

13230-14 14,0 cm, 5½" 13231-14

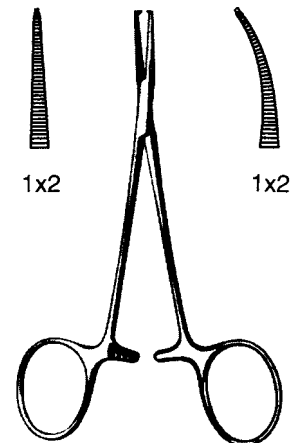

HALSTED-MOSQUITO micro

13232-12 12,5 cm, 5" 13233-12

Arterienklemmen
Hemostatic Forceps
Pinzas hemostáticas
Pinze emostatiche

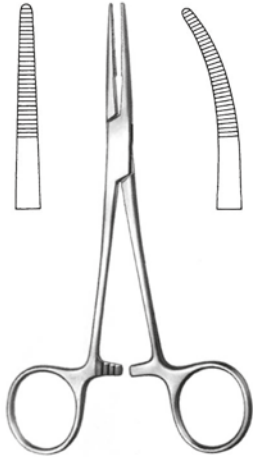

KELLY
 13240-14 14 cm, 5½" 13241-14
 13240-18 18 cm, 7" 13241-18
 13244-14 14 cm, 5½" 13245-14
 TITAN TITAN

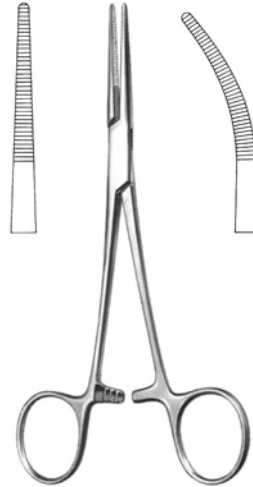

KELLY-RANKIN
 13242-16 16 cm, 6¼" 13243-16

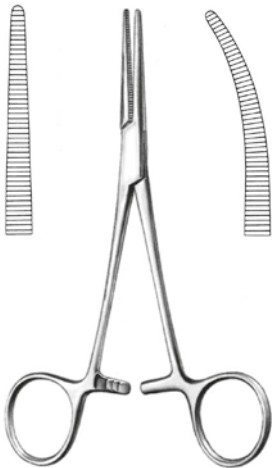

CRILE
 13250-14 14 cm, 5½" 13251-14
 13250-18 18 cm, 7" 13251-18
 13254-14 14 cm, 5½" 13255-14
 TITAN TITAN

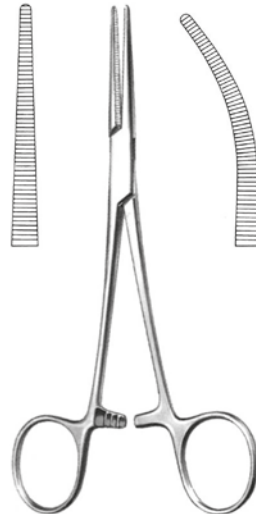

CRILE-RANKIN
 13262-16 16 cm, 6¼" 13263-16

Arterienklemmen
Hemostatic Forceps
Pinzas hemostáticas
Pinze emostatiche

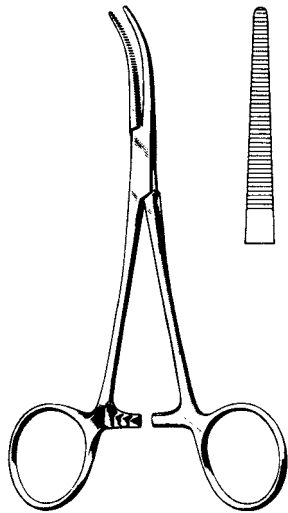

DANDY

13345-12 12 cm, 4 $\frac{3}{4}$ "
13345-14 14 cm, 5 $\frac{1}{2}$ "

Kopfschwartenzangen
Scalp Flap Forceps
Pinzas para el cuero cabelludo
Pinze per cuoio capelluto

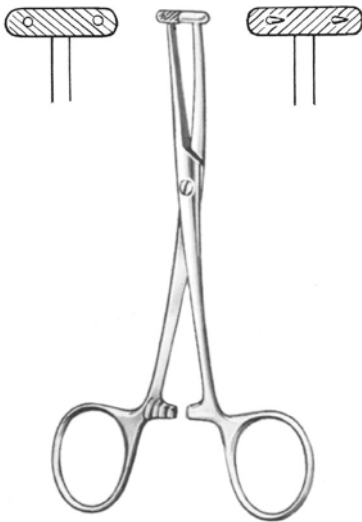

MARTEL
13364-14 14 cm, 5½"

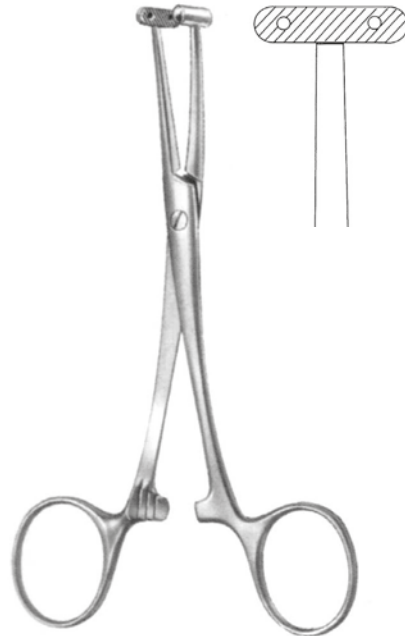

WILLET MARTEL
13366-19 19 cm, 7½"

Präparier- und Ligaturklemmen
Dissecting and Ligature Forceps
Pinzas para preparaciones y para ligaduras
Pinze per preparazione e per legatura



FUCHSIG
13414-20 19 cm, 7½"



ADSON BABY
13415-14 14,0 cm, 5½"
13415-18 18,5 cm, 7¼"

Präparier- und Ligaturklemmen
Dissecting and Ligature Forceps
Pinzas para preparaciones y para ligaduras
Pinze per preparazione e per legatura



GEMINI

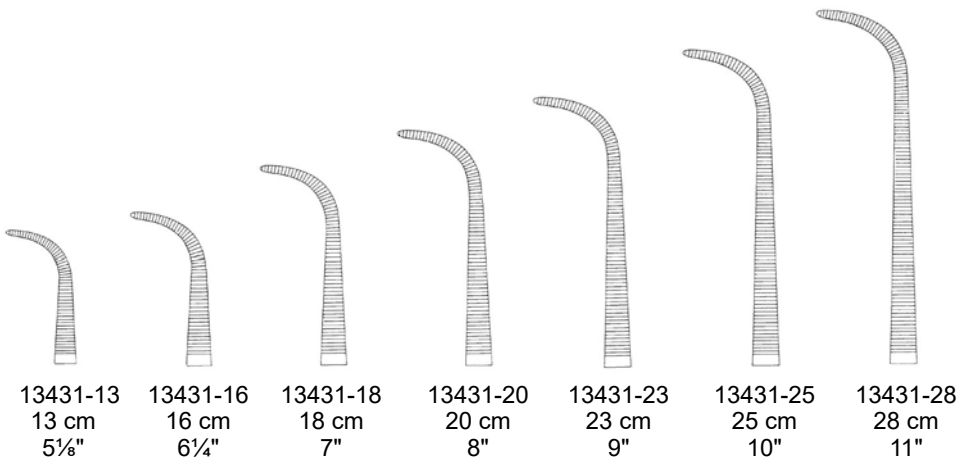

Präparier- und Ligaturklemmen
Dissecting and Ligature Forceps
Pinzas para preparaciones y para ligaduras
Pinze per preparazione e per legatura

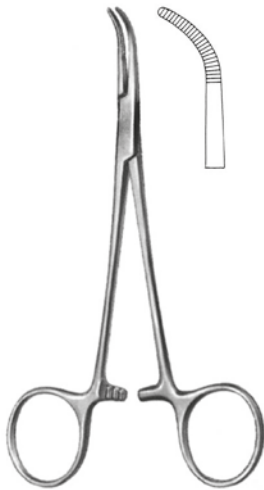

MIXTER BABY
13475-14
14 cm, 5½"



MIXTER BABY
13475-18
18 cm, 7"

Sehnenfaßzange
Tendon grasping Forceps
Pinza para agarrar tendones
Pinze da presa per tendini



CAROLL
33966-11
11 cm, 4 $\frac{3}{8}$ "

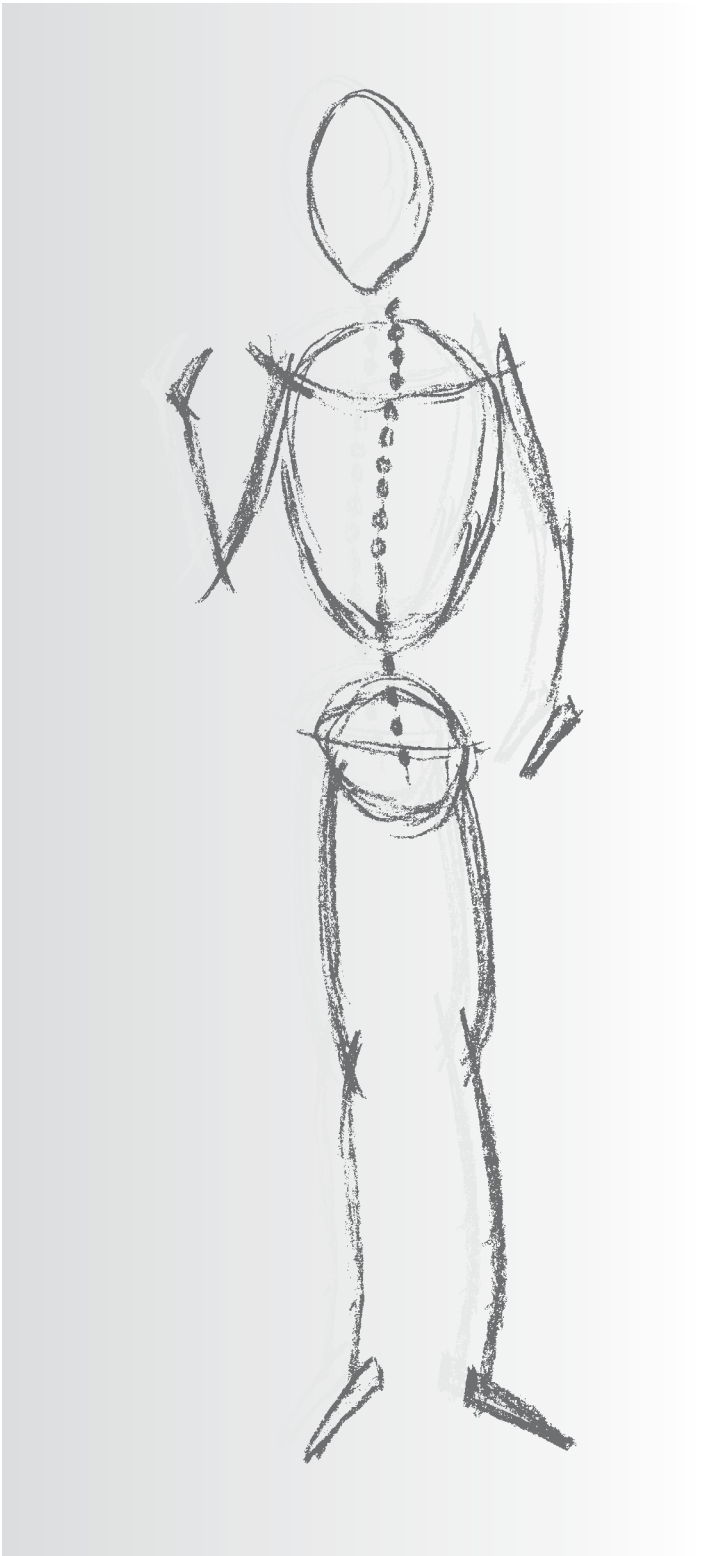

Reda Instrumente GmbH
Gänsäcker 34 - P.O. Box 131
D-78532 Tuttlingen

NADELHALTER

NEEDLE HOLDERS

PORTA-AGUJAS

PORT'AGHI

Nadelhalter
 Needle Holders
 Porta-agujas
 Port'aghi

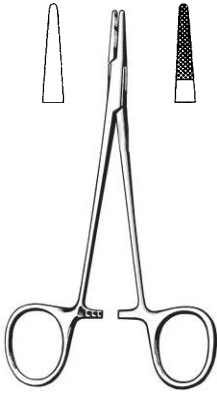

HALSEY
 25130-13 25140-13
 25134-13 TC 25144-13 TC
 13 cm, 5 1/8"

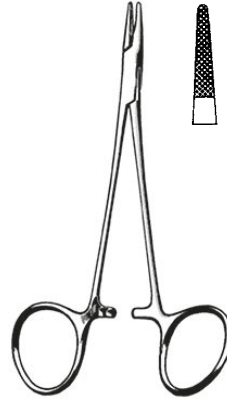

NEIVERT
 25148-13 TC
 13 cm, 5 1/8"



BAUMGARTNER
 25150-14 25154-14 TC
 14 cm, 5 1/2"



CRILE-WOOD
 25160-15 15 cm, 6" 25164-15 TC
 25160-18 18 cm, 7" 25164-18 TC
 25160-20 20 cm, 8" 25164-20 TC
 25160-23 23 cm, 9" 25164-23 TC

Nadelhalter
Needle Holders
Porta-agujas
Port'aghi

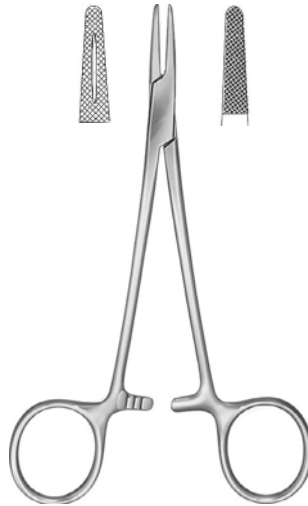

MAYO-HEGAR

25180-14	14 cm, 5½"	25184-14 TC
25180-16	16 cm, 6¼"	25184-16 TC
25180-18	18 cm, 7"	25184-18 TC
25180-20	20 cm, 8"	25184-20 TC
25180-24	24 cm, 9¼"	25184-24 TC
25180-26	26 cm, 10¼"	25184-26 TC



DE BAKEY

25214-16 TC	16 cm, 6¼"
25214-18 TC	18 cm, 7"
25214-20 TC	20 cm, 8"
25214-23 TC	23 cm, 9"
25214-26 TC	26 cm, 10¼"

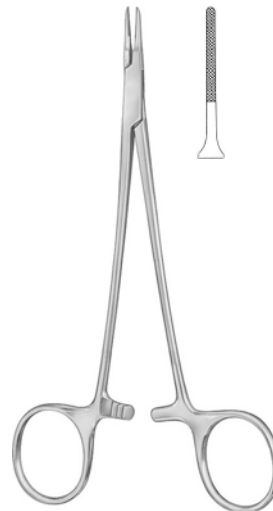

RYDER 1 mm

25224-13 TC	13 cm, 5⅝"
25224-15 TC	15 cm, 6"
25224-18 TC	18 cm, 7"
25224-20 TC	20 cm, 8"
25224-23 TC	23 cm, 9"
25224-26 TC	26 cm, 10¼"

RYDER 2 mm

25225-13 TC
25225-15 TC
25225-18 TC
25225-20 TC
25225-23 TC
25225-26 TC

Mikro-Nadelhalter
 Micro Needle Holders
 Micro-porta-agujas
 Micro portaghi

ohne Sperre
 without lock
 sin cremallera
 senza cremagliera

mit Sperre
 with lock
 con cremallera
 con cremagliera



11,5 cm, 4½"
 13,0 cm, 5⅙"
 14,0 cm, 5½"
 18,0 cm, 7"
 21,0 cm, 8¼"
 23,0 cm, 9"

25660-12
 25660-13
 25660-14
 25700-18

25661-12
 25661-13
 25661-14
 25701-18

25720-12
 25720-13
 25720-14
 25730-18
 25730-21
 25730-23

25731-12
 25731-13
 25731-14
 25731-18
 25731-21
 25731-23

mit diamantiertem Maul
 with diamond jaw
 con boca de diamante
 con morso diamantato

11,5 cm, 4½"
 13,0 cm, 5⅙"
 14,0 cm, 5½"
 18,0 cm, 7"
 21,0 cm, 8¼"
 23,0 cm, 9"

25720-12D
 25720-13D
 25720-14D
 25730-18D
 25730-21D
 25730-23D

25671-12D
 25671-13D
 25671-14D
 25731-18D
 25731-21D
 25731-23D

T = Titan, titanium, titanio, titanio



15,0 cm, 6"
 18,0 cm, 7"
 21,0 cm, 8¼"

93250-15T
 93250-18T
 93250-21T

93251-15T
 93251-18T
 93251-21T

93260-15T
 93260-18T
 93260-21T

93261-15T
 93261-18T
 93261-21T



BARRAQUER

Mikro-Nadelhalter mit Sperre
 Micro Needle Holders, with lock
 Micro-porta-agujas con cremallera
 Micro portaghi, con cremagliera

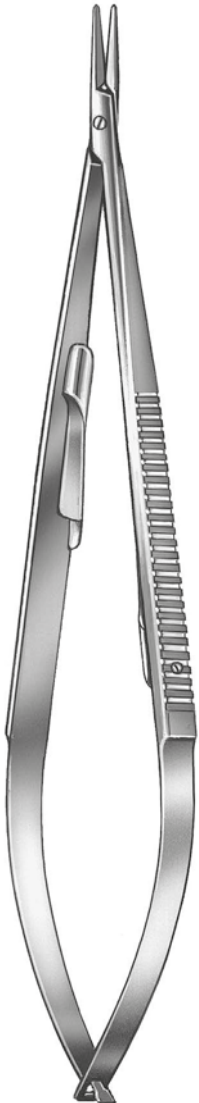

14,0 cm, 5½"
 18,0 cm, 7"
 21,5 cm, 8½"
 23,0 cm, 9"



25670-14
 25670-18
 25670-21



25671-14
 25671-18



25672-14
 25672-18
 25672-21
 25672-23



25673-14
 25673-18

mit TC 1,4 mm
 with TC jaw 1,4 mm
 con TC 1,4 mm
 con morso in TC 1,4 mm

14,0 cm, 5½"
 18,0 cm, 7"
 21,5 cm, 8½"
 23,0 cm, 9"

25674-14	25675-14	25676-14	25677-14
25674-18	25675-18	25668-18	25691-18
25674-21		25668-21	
		25668-23	

mit diamantiertem Maul 0,8 mm
 with diamond jaw 0,8 mm
 con boca de diamante 0,8 mm
 con morso diamantato 0,8 mm

14,0 cm, 5½"
 18,0 cm, 7"
 21,5 cm, 8 ½"
 23,0 cm, 9"

25672-14D	25673-14D
25672-18D	25673-18D
25672-21D	
25672-23D	

T = Titan, titanium, titanio, titanio
 Maul/jaw/boca/morso 0,4mm

14,0 cm, 5 ½"
 18,0 cm, 7"
 21,5 cm, 8½"

25672-14T	25673-14T
25672-18T	25673-18T
25672-21T	25673-21T

CASTROVIEJO

Mikro-Nadelhalter, bajonettförmig
Micro Needle Holders, bayonet-shaped
Micro-porta-agujas, forma bayoneta
Micro port'aghi, forma baionetta



93092-20	200 mm / 8"
93092-22	225 mm / 9"



93093-16	165 mm / 6½"
93093-20	200 mm / 8"
93093-22	225 mm / 9"
93093-24	245 mm / 9¾"

YASARGIL

Mikro-Nadelhalter
Micro Needle Holders
Micro-porta-agujas
Micro port'aghi



93170-16 160 mm / 6¼"
93170-18 185 mm / 7¼"
ohne Sperre
without catch
sin cremallera
senza cremagliera



93171-16 160 mm / 6¼"
93171-18 185 mm / 7¼"
ohne Sperre
without catch
sin cremallera
senza cremagliera



Mikro-Nadelhalter
Micro Needle Holders
Micro-porta-agujas
Micro port'aghi



93200-16
93200-18

160 mm / 6¼"
185 mm / 7¼"

ohne Sperre
without catch
sin cremallera
senza cremagliera

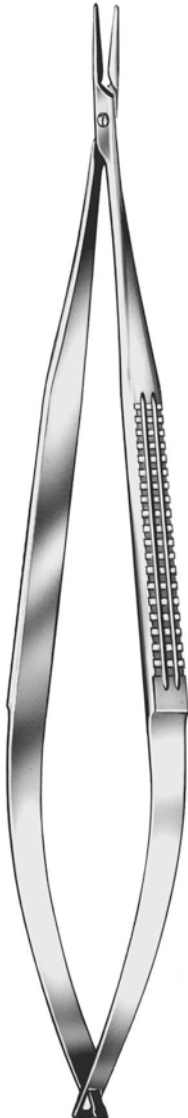

93201-16
93201-18

160 mm / 6¼"
185 mm / 7¼"

ohne Sperre
without catch
sin cremallera
senza cremagliera

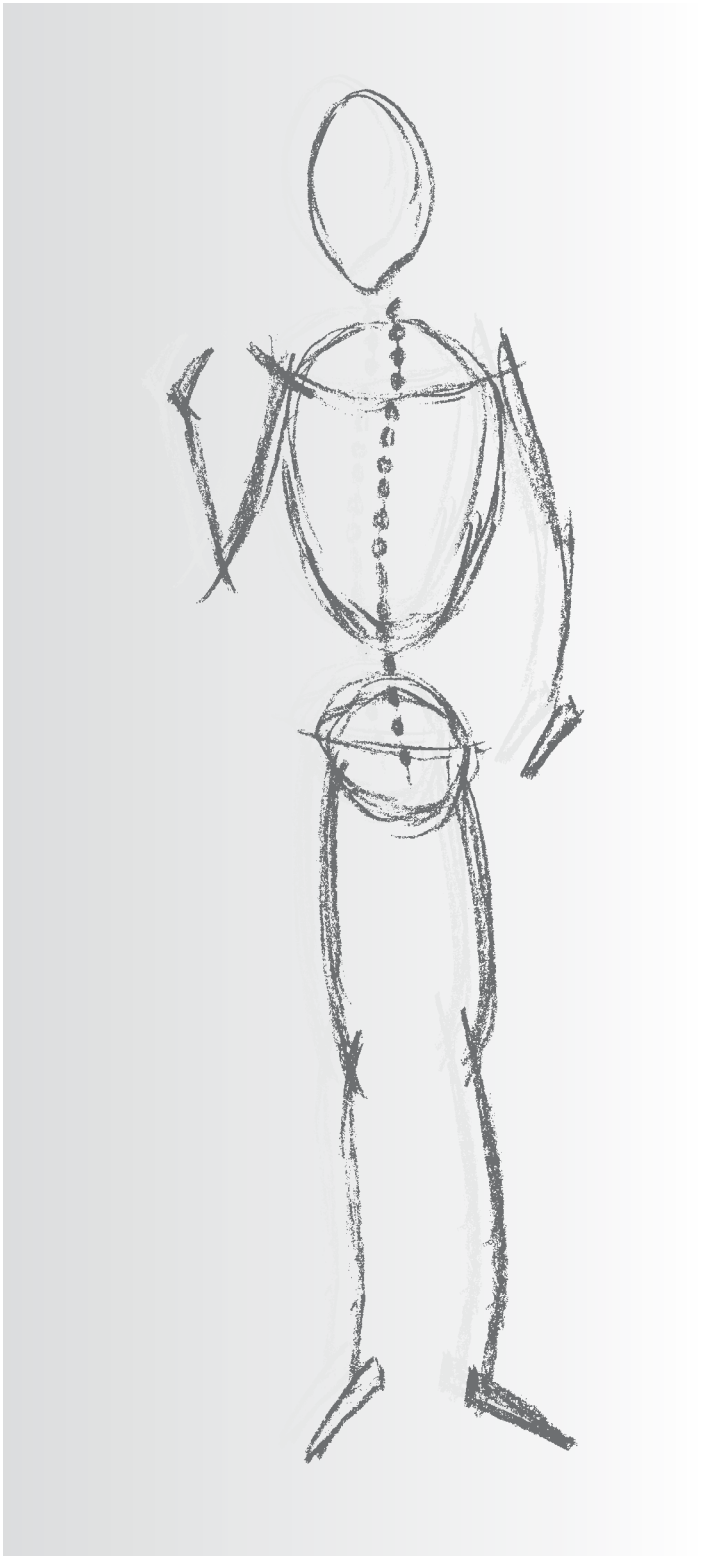

Reda Instrumente GmbH
Gänsäcker 34 - P.O. Box 131
D-78532 Tuttlingen

HAKEN

HOOKS

GANCHOS

UNCINI

Hauthäkchen
 Skin Hooks
 Ganchos para la piel
 Uncini per pelle



scharf
 sharp
 agudo
 acuto
 A



stumpf
 blunt
 romo
 smusso
 B

FRAZIER

- A 19214-13 13 cm, 5"
- A 19214-18 18 cm, 7"
- B 19215-13 13 cm, 5"
- B 19215-18 18 cm, 7"



19216-01
 1 mm



19216-02
 2 mm



19216-05
 5 mm



19216-07
 7 mm



19216-10
 10 mm

JOSEPH
 16 cm, 6¼"



FREER
 47558-15
 15 cm, 6"



Fig. 1
 47560-18



Fig. 2
 47562-18

GILLIES
 18 cm, 7"

Wundhaken
Retractors
Separadores
Divaricatori



Blattretractor
blade retractor
separador de hoja
lama divaricatore

CLOWARD
19128-18 18 mm
19128-20 20 mm
19128-23 23 mm



CUSHING
19234-20
20 cm, 8"



CUSHING
19235-21
21,5 cm, 8½"

Wundhaken
Retractors
Separadores
Divaricatori

- 19314-07 35x 7 mm
- 19314-10 35x10 mm
- 19314-12 80x12 mm
- 19314-14 70x14 mm
- 19314-15 35x15 mm
- 19314-16 80x16 mm
- 19314-20 60x20 mm
- 19315-06 25x 6 mm
- 19330-40 40x12 mm
- 19330-55 55x11 mm

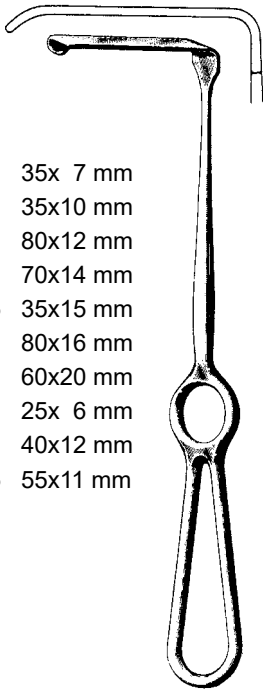

KOCHER-LANGENBECK
21 cm, 8¼"

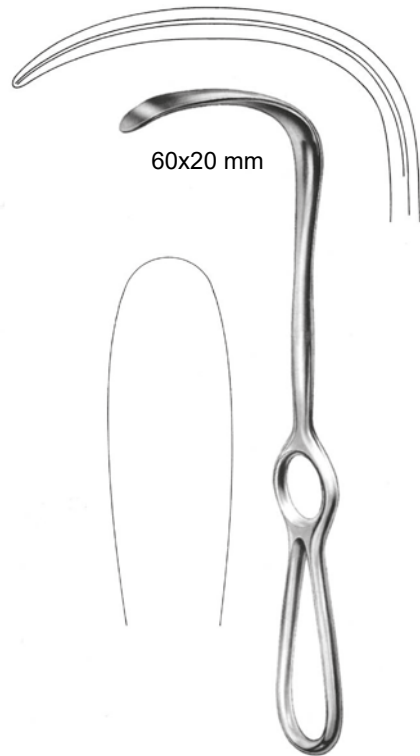

LANGENBECK
19315-21
21 cm, 8¼"

Wundhaken
Retractors
Separadores
Divaricatori

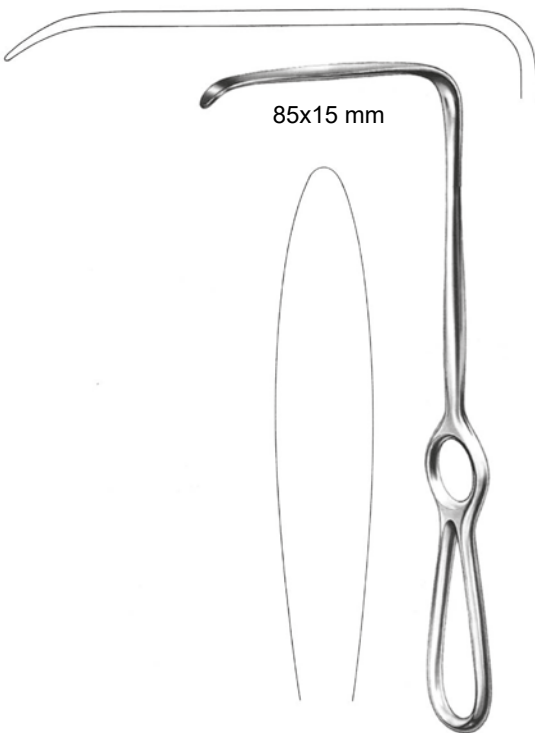

85x15 mm

LANGENBECK
19317-21
21 cm, 8¼"

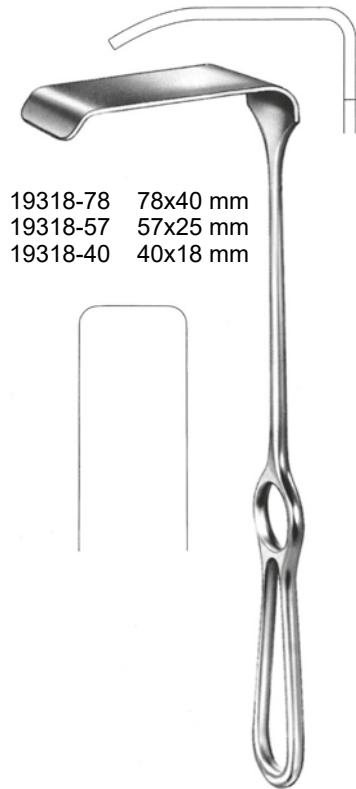

19318-78 78x40 mm
19318-57 57x25 mm
19318-40 40x18 mm

KOCHER
23 cm, 9"

Wundhaken
Retractors
Separadores
Divaricatori

19694-01
50 x 16 mm
20 cm, 8"



19694-02
75 x 25 mm
23 cm, 9"



19694-03
90 x 50 mm
24 cm, 9½"

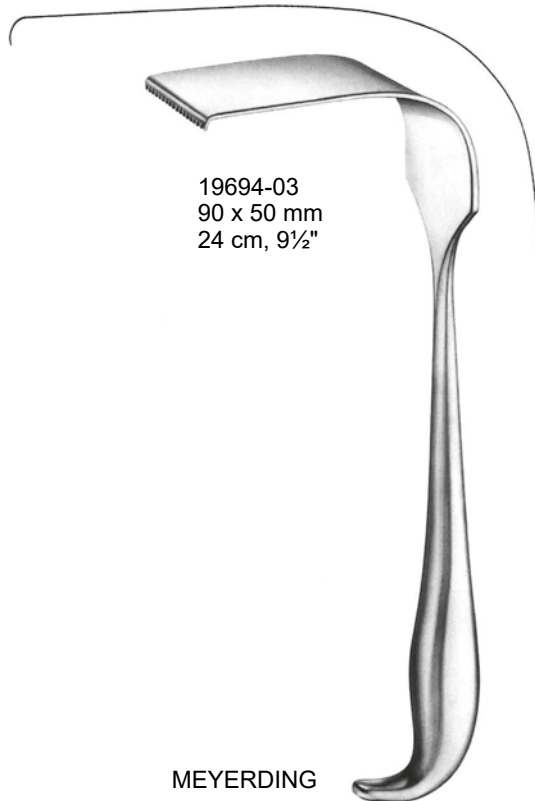

MEYERDING

Spinalhaken
Spinal retractors
Separadores espinales
Divaricatori spinali



TAYLOR
16,5 cm, 6½"
33831-16 75 x 30 mm
33833-16 100 x 30 mm

Nervhaken, Durahaken
Nerve Hooks, Dura Hooks
Ganchos para nervios y para dura-madre
Unicini per nervi e per dura-madre



DANDY
41051-20
20 cm, 8"



DANDY
41052-20
20 cm, 8"



DANDY
41053-20
20 cm, 8"

Nervhaken, Durahaken
Nerve Hooks, Dura Hooks
Ganchos para nervios y para dura-madre
Unicini per nervi e per dura-madre



CRILE
41054-20
20 cm, 8"

Fig. 1



CUSHING
41056-18 18 cm, 7"
41056-28 28 cm, 11"

Fig. 2



CUSHING
41058-18 18 cm, 7"
41058-28 28 cm, 11"

Nervhaken, Durahaken
Nerve Hooks, Dura Hooks
Ganchos para nervios y para dura-madre
Unicini per nervi e per dura-madre



GRAHAM
41061-16
16,5 cm, 6½"



SACHS
41064-16
18,5 cm, 7¼"



ADSON
41068-20
20 cm, 8"



ADSON
41069-20
20 cm, 8"



SMITHWICK
41070-29
29 cm, 11.4"

Nervwurzelhaken
Nerve Root Retractors
Separadores de raiz de nervios
Uncini per le radici dei nervi



SCOVILLE
41074-23
23 cm, 9"



HOLSHER
41075-24
24 cm, 9½"

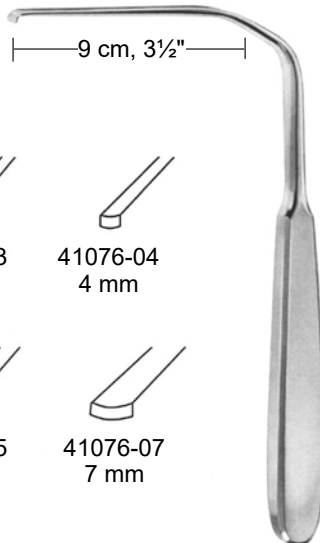

HESS
17,5 cm, 7"



41076-03
3 mm



41076-04
4 mm



41076-05
5 mm



41076-07
7 mm

Nervwurzelnhaken
Nerve Root Retractors
Separadores de raiz de nervios
Uncini per le radici dei nervi



CASPAR
24 cm, 9½"

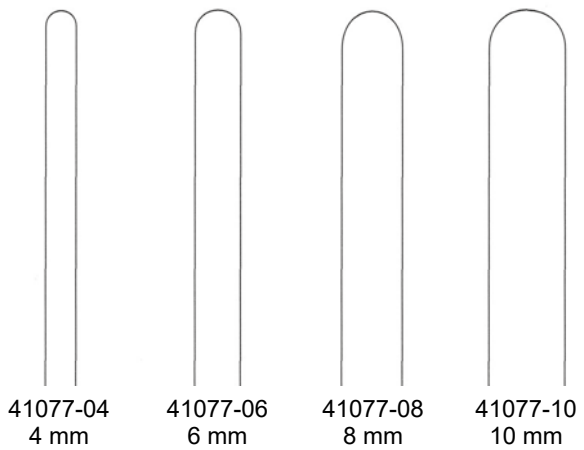

Nervwurzelhaken
Nerve Root Retractors
Separadores de raiz de nervios
Uncini per le radici dei nervi



D'ERRICO
41078-23
23 cm, 9"



LOVE
41079-21
21 cm, 8¼"

Nervwurzelnhaken, Galea Haken
 Nerve Root Retractors, Galea Hooks
 Separadores de raiz de nervios, Gancho para galea
 Uncini per le radici dei nervi, Uncini galea

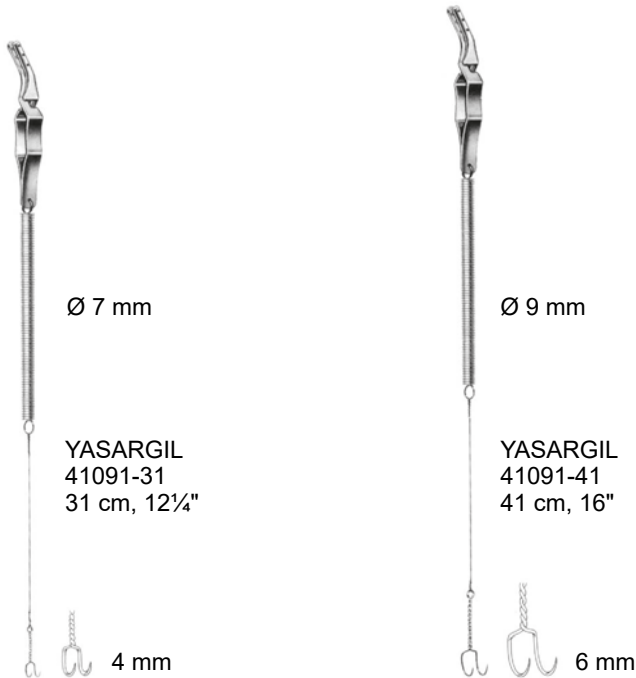
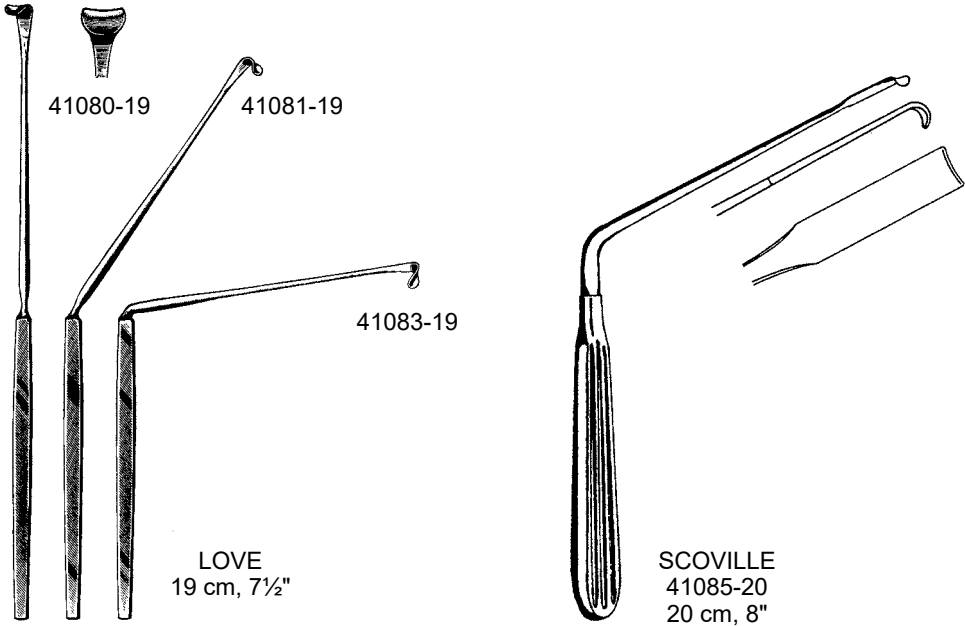

Explorations- und Koagulationshäkchen
 Exploration- and Coagulation Hooks
 Ganchos para exploración y coagulación
 Uncini per esplorazione e coagulazione



CASPAR
 245 mm
 9 3/4"

5 mm



93400-01

isoliert / insulated
 aislado / isolato

93400-02

nicht isoliert / not insulated
 no-aislado / non isolato

8 mm



93401-01

isoliert / insulated
 aislado / isolato

93401-02

nicht isoliert / not insulated
 no-aislado / non isolato

11 mm



93402-01

isoliert / insulated
 aislado / isolato

93402-02

nicht isoliert / not insulated
 no-aislado / non isolato



93403-01

isoliert / insulated
 aislado / isolato

93403-02

nicht isoliert / not insulated
 no-aislado / non isolato

Fadenführer, Nerv- und Gefäßhäkchen
 Ligature Guides, Nerve- and Vessel Hooks
 Guia para ligaduras, ganchos para nervios y vasos
 Conduttori per legature, uncini per nervi e vasi



YASARGIL
 185 mm / 7¼"

Fadenführer geknöpft
 Ligature Guides, probe pointed
 Guiador abotonado
 Conduttore bottonuto per legature



93405-01



93405-02



93405-03



93405-04



41242-19



41243-19

KRAYENBÜHL
 185 mm / 7¼"

Nerv- und Gefäßhäkchen
 Nerve- and Vessel Hooks
 Ganchos para nervios y vasos
 Uncini per nervi e vasi



41244-19



41245-19

Mikro-Häkchen, Mikro-Gefäßmesser
 Micro Hooks, Micro Vessel Knives
 Micro-ganchitos y micro-cuchillos
 Micro uncinetti e micro coltelli per vasi



}	93450-01	230 mm / 9" scharf sharp agudo acuto	
}	93450-02	230 mm / 9" stumpf blunt romo smusso	
90° }	41236-19	185 mm / 7¼" scharf, gebogen sharp, curved agudo, curvado acuto, curva	FISCH
90° }	41237-19	185 mm / 7¼" scharf, abgewinkelt sharp, angled agudo, angulado acuto, angolato	FISCH
}	93450-04	185 mm / 7¼" Mikro-Gefäßmesser Micro Vessel Knife Micro-cuchillo Micro coltello per vasi	JACOBSON

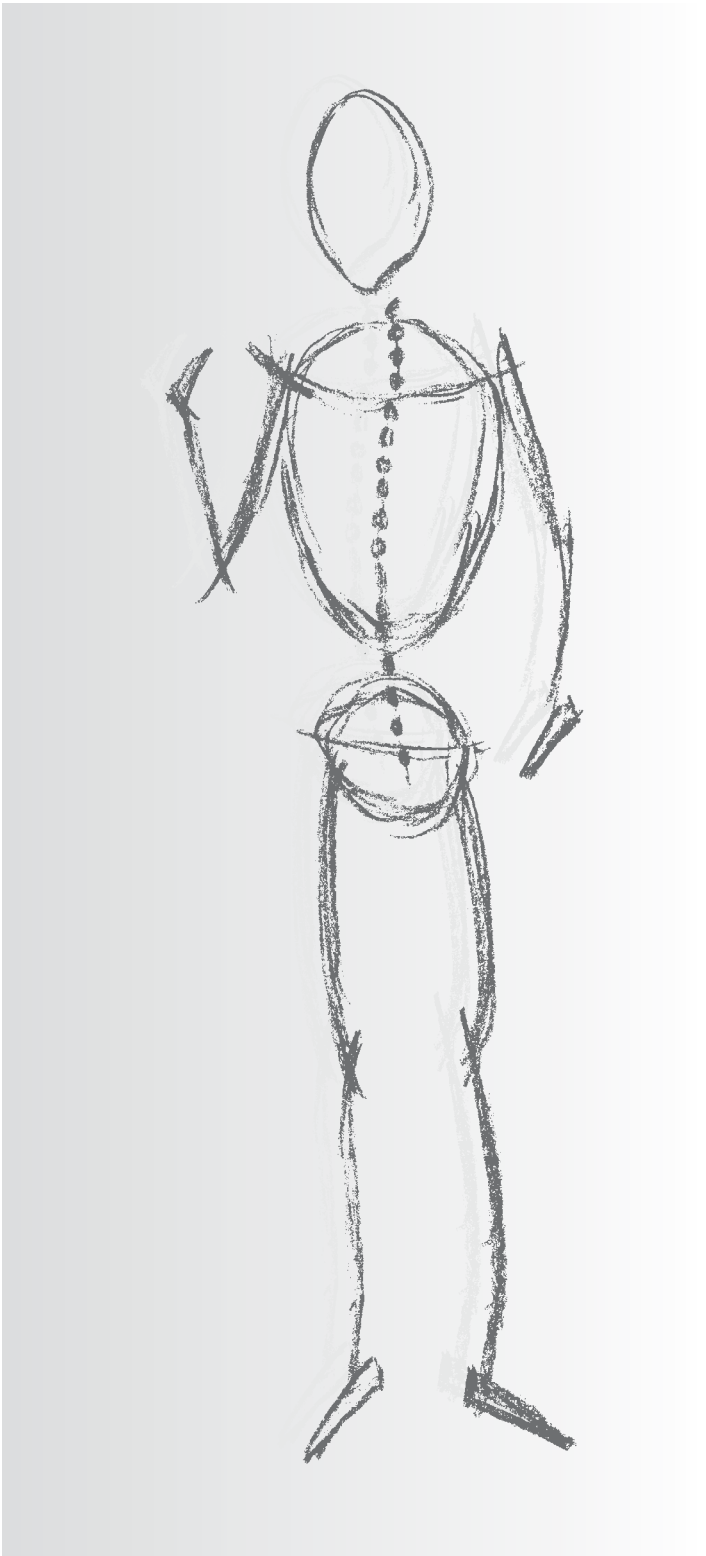

Reda Instrumente GmbH
Gänsäcker 34 - P.O. Box 131
D-78532 Tuttlingen

SPREIZER

SPREADER

SEPARADORES

DIVARICATORI

Wundspreizer
 Self-retaining Retractors
 Separadores autoestáticos
 Divaricatori autostatici

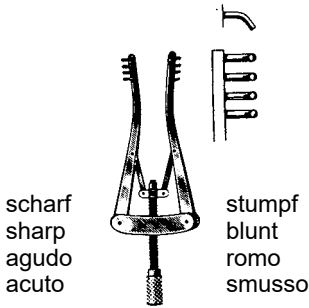

scharf
 sharp
 agudo
 acuto

stumpf
 blunt
 romo
 smusso

ALM

19620-07 7 cm, 2¾"
 19620-10 10 cm, 4"

19621-07
 19621-10

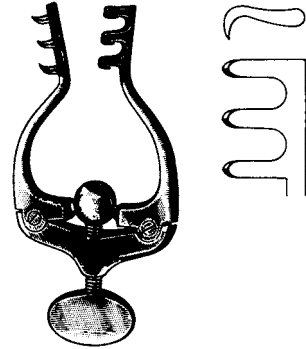

JANSEN
 19630-10
 10 cm, 4"

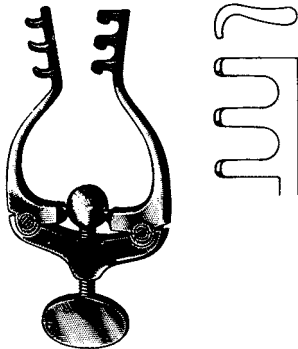

JANSEN
 19631-10
 10 cm, 4"

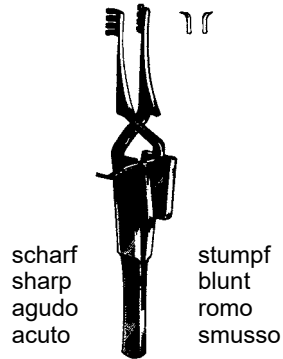

scharf
 sharp
 agudo
 acuto

stumpf
 blunt
 romo
 smusso

HOLZHEIMER
 19634-10 19635-10
 10 cm, 4"

Wundspreizer
Self-retaining Retractors
Separadores autoestáticos
Divaricatori autostatici

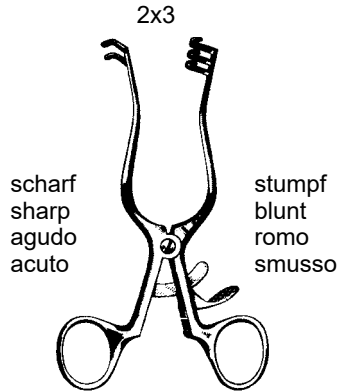

WEITLANER
19650-10 19651-10
11,5 cm, 4½"

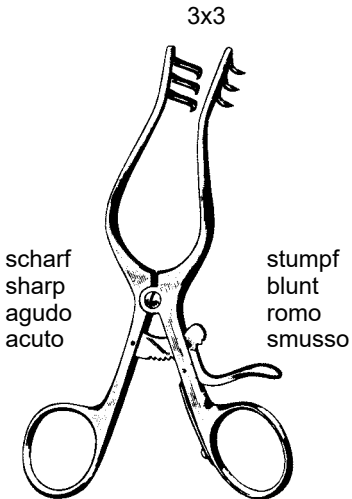

WEITLANER-WULLSTEIN
19654-13 19655-13
13 cm, 5⅛"

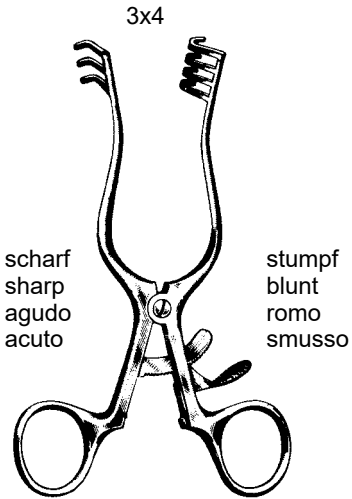

WEITLANER
19670-14 14,0 cm, 5½" 19671-14
19670-16 16,5 cm, 6½" 19671-16
19670-20 20,0 cm, 8" 19671-20
19670-24 24,0 cm, 9½" 19671-24

Wundspreizer
Self-retaining Retractors
Separadores autoestáticos
Divaricatori autostatici

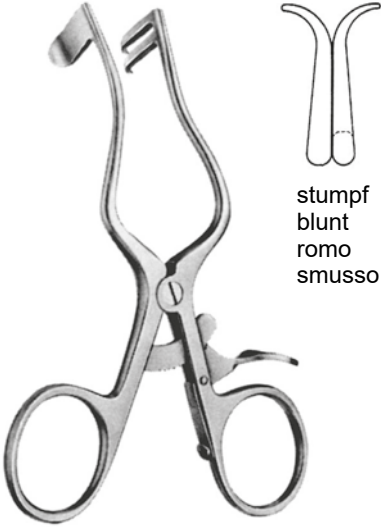

stumpf
blunt
romo
smusso

PLESTER
19672-11 11 cm, 4 $\frac{3}{8}$ "

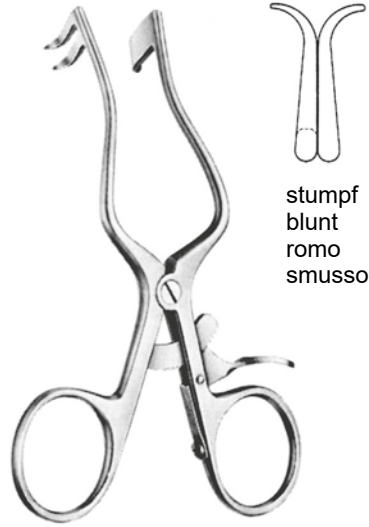

stumpf
blunt
romo
smusso

PLESTER
19673-11 11 cm, 4 $\frac{3}{8}$ "

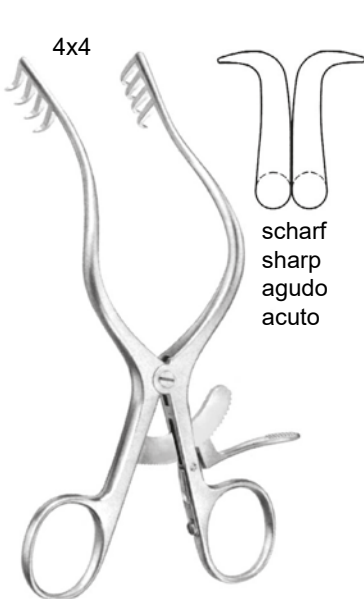

4x4

scharf
sharp
agudo
acuto

MOLLISON
19674-15 15 cm, 6"

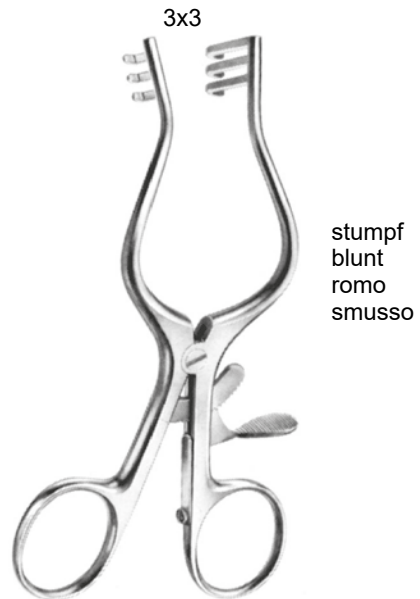

3x3

stumpf
blunt
romo
smusso

WULLSTEIN
19675-13 13 cm, 5 $\frac{1}{8}$ "

Wundspreizer
Self-retaining Retractors
Separadores autoestáticos
Divaricatori autostatici

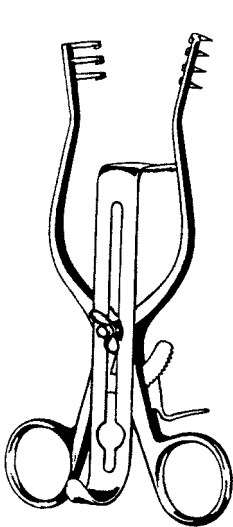

HENLEY
16,5 cm, 6½"



19675-00 komplett, stumpf, 3x4 Z. und 3 Valven
19675-00 complete, blunt, 3x4 teeth and 3 blades
19675-00 completo, romo, 3x4 dientes y 3 valvas
19675-00 completo, smusso, 3x4 d. e 3 valve

19676-00 komplett, scharf, 3x4 Z. und 3 Valven
19676-00 complete, sharp, 3x4 teeth and 3 blades
19676-00 completo, agudo, 3x4 dientes y 3 valvas
19676-00 completo con retr. acuto 3x4 d. e 3 valve

19678-05 Retraktor allein, stumpf 3x4 Zähne
19678-05 Retractor only, blunt 3x4 teeth
19678-05 Separador solo, romo, 3x4 dientes
19678-05 Retrattore solo, smusso 3x4 denti

19678-06 Retraktor allein, scharf 3x4 Zähne
19678-06 Retractor only, sharp 3x4 teeth
19678-06 Separador solo, agudo, 3x4 dientes
19678-06 Retrattore solo, acuto 3x4 denti

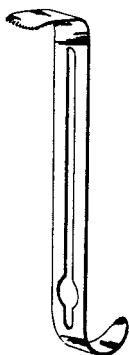

19677-19
16x19 mm
5/8" x 3/4"

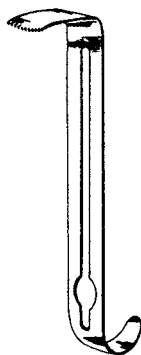

19677-25
16x25 mm
5/8" x 1"

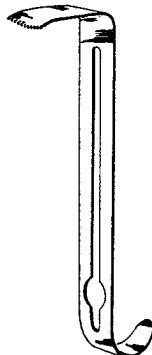

19677-32
16x32 mm
5/8" x 1¼"

Wundspreizer
Self-retaining Retractors
Separadores autoestáticos
Divaricatori autostatici



PLESTER
19677-13 13 cm, 5 1/8"

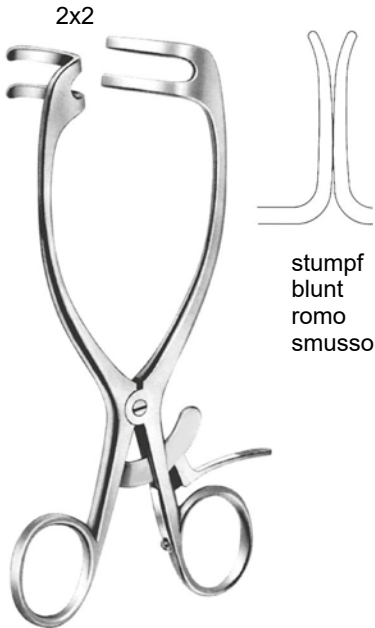

MAYO-ADAMS
19678-16 16,5 cm, 6 1/2"

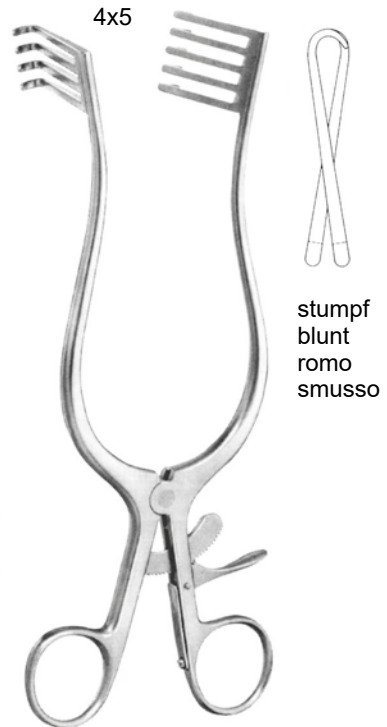

NORFOLK-NORWICH
19679-22 22 cm, 8 3/4"

Wundspreizer
 Self-retaining Retractors
 Separadores autoestáticos
 Divaricatori autostatici



4x4

scharf
 sharp
 agudo
 acuto

ADSON
 19680-19 19 cm, 7½" 19681-19



4x5



stumpf
 blunt
 romo
 smusso

TRAVERS
 19681-21 21,5 cm, 8½"

stumpf
 blunt
 romo
 smusso

Wundspreizer
Self-retaining Retractors
Separadores autoestáticos
Divaricatori autostatici

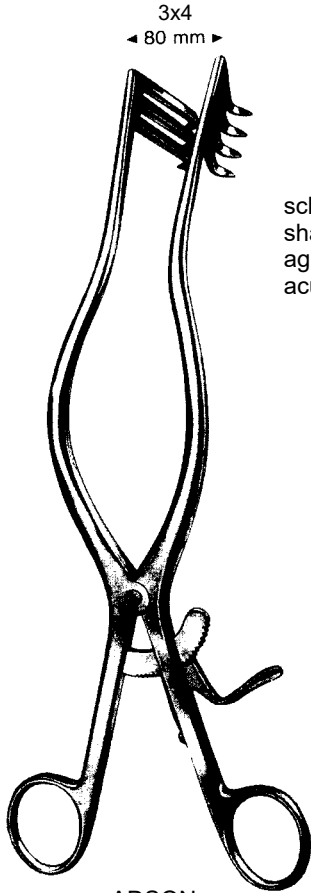

ADSON
26,5 cm, 10½"

3x4
◀ 80 mm ▶

scharf
sharp
agudo
acuto

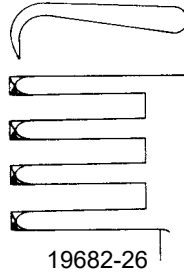

19682-26

stumpf
blunt
romo
smusso

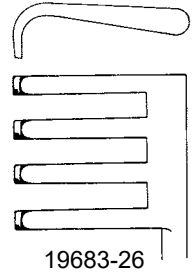

19683-26

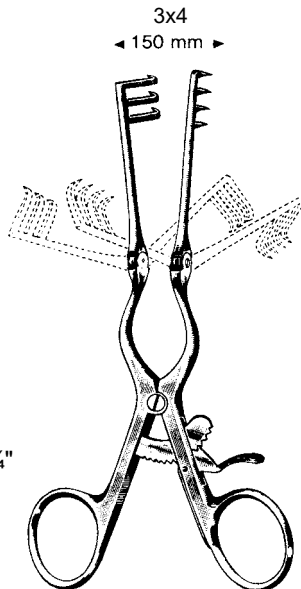

BECKMANN-ADSON (CONE)

3x4
◀ 150 mm ▶

- 19684-14 14 cm, 5½"
- 19684-16 16 cm, 6¼"
- 19684-20 20 cm, 8"
- 19684-26 26 cm, 10¼"

scharf
sharp
agudo
acuto

- 19685-14 14 cm, 5½"
- 19685-16 16 cm, 6¼"
- 19685-20 20 cm, 8"
- 19685-26 26 cm, 10¼"

stumpf
blunt
romo
smusso

Kopfhautspreizer
Scalp Retractor
Separador para el cuero cabelludo
Divaricatore autostatico per cuoio capelluto

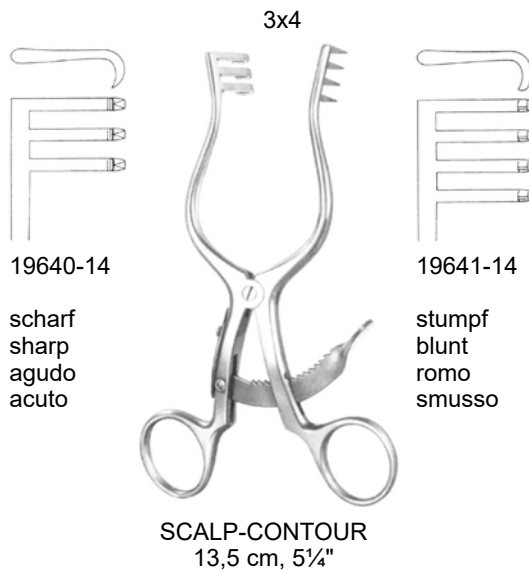

Zerebellum-Spreizer
 Cerebellar Retractor
 Separador para cerebello
 Divaricatore per cervelletto

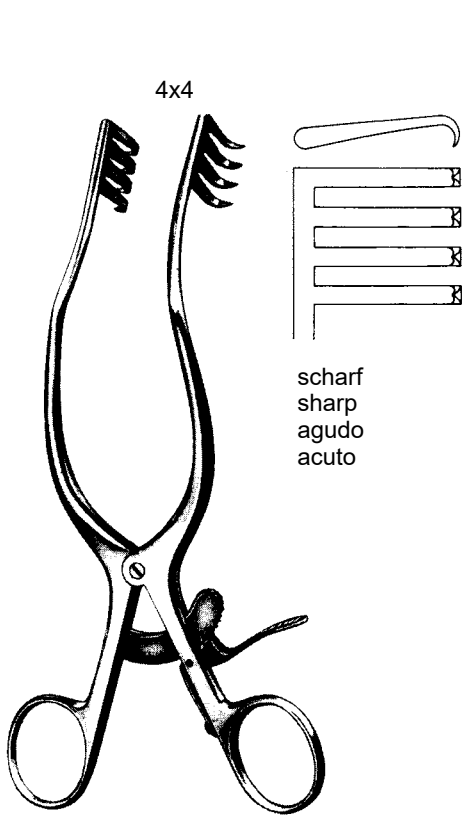

ANDERSON ADSON
 19679-20 19,5 cm, 7¾"

scharf
 sharp
 agudo
 acuto

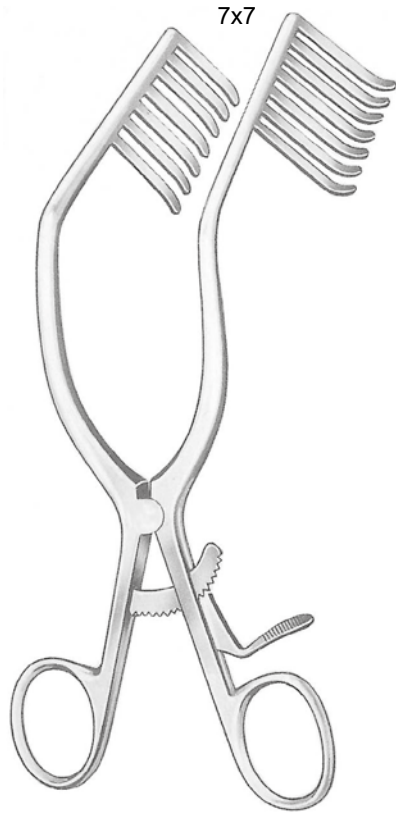

MISKIMON
 22 cm, 8¾"

19693-01
 scharf
 sharp
 agudo
 acuto

19693-02
 stumpf
 blunt
 romo
 smusso

Laminektomie-Wundspreizer
Laminectomy Retractors
Separadores para laminectomía
Divaricatori per laminectomia



ADSON
19686-32
32 cm, 12³/₄"

Laminektomie-Wundspreizer
 Laminectomy Retractors
 Separadores para laminectomía
 Divaricatori per laminectomia

4x4



BECKMANN-ADSON
 31 cm, 12³/₄"

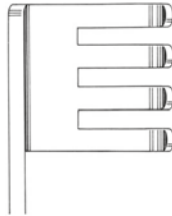

19687-01
 25 x 27 mm
 stumpf
 blunt
 romo
 smusso

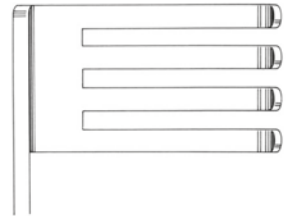

19688-01
 45 x 27 mm
 stumpf
 blunt
 romo
 smusso

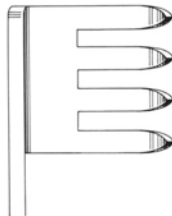

19687-02
 25 x 27 mm
 scharf
 sharp
 agudo
 acuto

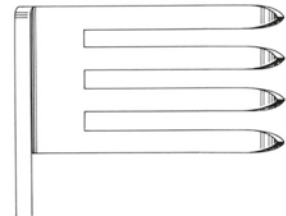

19688-02
 45 x 27 mm
 scharf
 sharp
 agudo
 acuto

Laminektomie-Wundspreizer
Laminectomy Retractors
Separadores para laminectomía
Divaricatori per laminectomia



28,5 cm, 11¼"

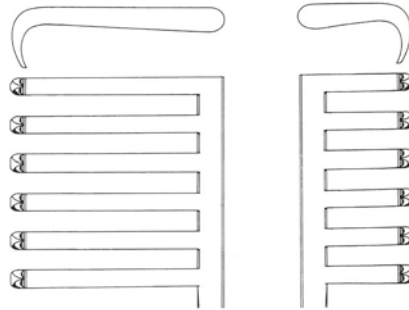

19689-01

scharf, lange Zähne links
sharp, long teeth on left side
agudo, dientes largos a la izquierda
acuto, denti lunghi a sinistra

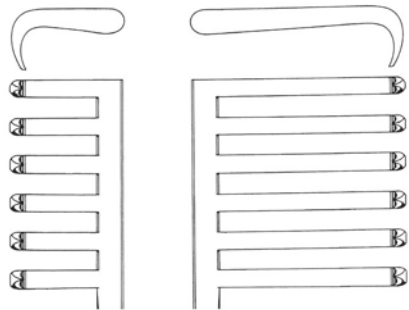

19689-02

scharf, lange Zähne rechts
sharp, long teeth on right side
agudo, dientes largos a la derecha
acuto, denti lunghi a destra

Laminektomie-Wundspreizer
Laminectomy Retractors
Separadores para laminectomía
Divaricatori per laminectomia

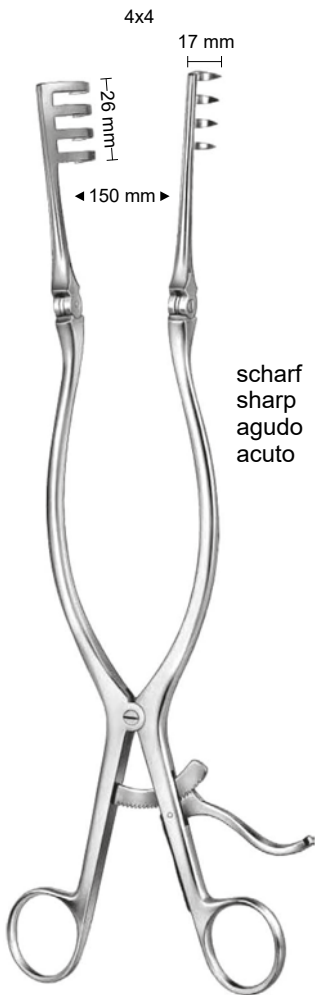

scharf
sharp
agudo
acuto

BECKMANN
19690-31
31 cm, 12¼"

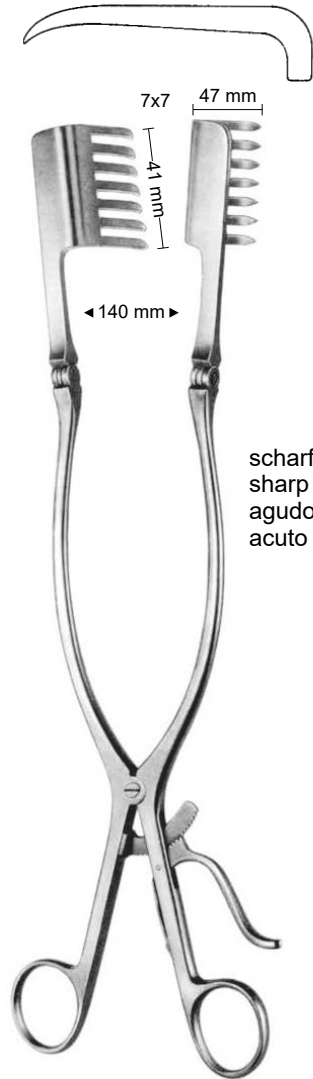

scharf
sharp
agudo
acuto

BECKMANN-EATON
19692-32
32 cm, 12¾"

Laminektomie-Wundspreizer
Laminectomy Retractors
Separadores para laminectomía
Divaricatori per laminectomia

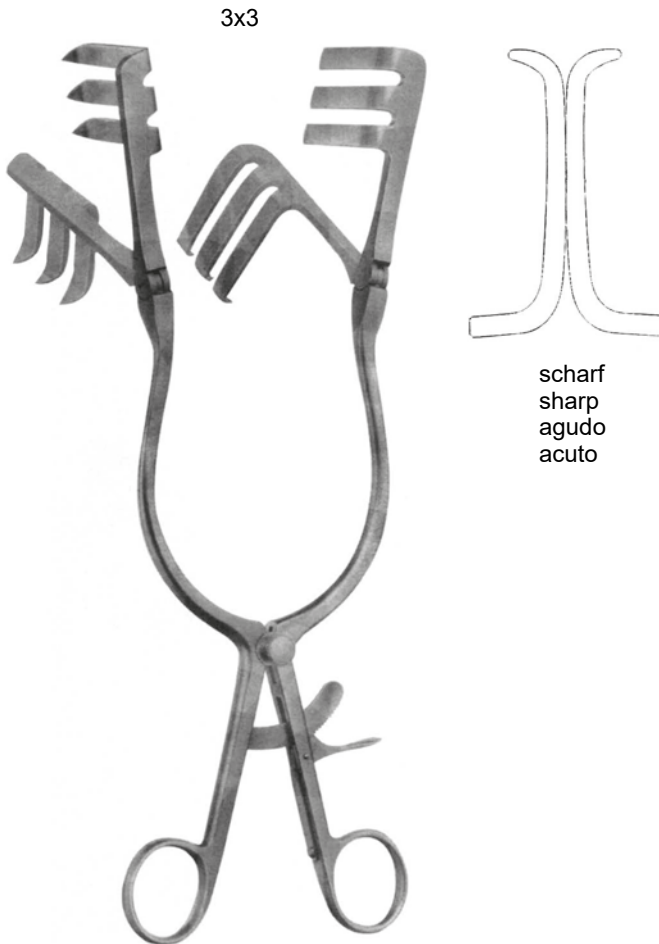

scharf
sharp
agudo
acuto

HARVEY-JACKSON
19693-28
28 cm, 11"

Laminektomie-Wundspreizer
Laminectomy Retractors
Separadores para laminectomía
Divaricatori per laminectomia

Blätter rechts
blades right hand side
valvas a la derecha
Lame destra



KNIGHTON
19694-18
18 cm, 7"

Blätter links
blades left hand side
valvas a la izquierda
Lame sinistra



KNIGHTON
19695-18
18 cm, 7"

Laminektomie-Wundspreizer
Laminectomy Retractors
Separadores para laminectomía
Divaricatori per laminectomia

Blätter rechts
blades right hand side
valvas a la derecha
Lame destra



WALTON
19695-01
18 cm, 7"

Blätter links
blades left hand side
valvas a la izquierda
Lame sinistra



WALTON
19695-02
18 cm, 7"

Laminektomie-Wundspreizer
 Laminectomy Retractors
 Separadores para laminectomía
 Divaricatori per laminectomia



19770-00 CASPAR
 Sperrer mit Haken 19772-38 und
 5 Blättern 19774-37 - 19774-57
 Retractor with hook 19772-38 and
 5 blades 19774-37 - 19774-57
 Retractor con gancho 19772-38 y
 5 hojas 19774-37 - 19774-57
 Divaricatore con gancio 19772-38 e
 5 valve 19774-37 - 19774-57

19770-11
 Sperrer, alleine
 Retractor, only
 Retractor, suelto
 Divaricatore solo



19779-00
 Drehschlüssel alleine
 Key only
 Llave sola
 Chiave sola



19772-38	Haken	38 mm
	Hook	38 mm
	gancho de	38 mm
	gancio	38 mm
19772-58	Haken	58 mm
	Hook	58 mm
	gancho de	58 mm
	gancio	58 mm



19774-32	32 x 22 mm
19774-37	37 x 22 mm
19774-43	43 x 22 mm
19774-47	47 x 22 mm
19774-52	52 x 22 mm
19774-57	57 x 22 mm
19774-62	62 x 22 mm
19774-67	67 x 22 mm

Blätter / blades
 hojas / valve



19776-32	32 x 37 mm
19776-37	37 x 37 mm
19776-43	43 x 37 mm
19776-47	47 x 37 mm
19776-52	52 x 37 mm
19776-57	57 x 37 mm
19776-62	62 x 37 mm
19776-67	67 x 37 mm

Blätter / blades
 hojas / valve



19778-32	32 x 52 mm
19778-37	37 x 52 mm
19778-43	43 x 52 mm
19778-47	47 x 52 mm
19778-52	52 x 52 mm
19778-57	57 x 52 mm
19778-62	62 x 52 mm
19778-67	67 x 52 mm

Blätter / blades
 hojas / valve

Laminektomiespreizer
Laminectomy Retractors
Separadores para laminectomia
Divaricatori per laminectomia

SCOVILLE-HAVERFIELD
19910-00
Rahmen allein
Frame only
Marco solo
Telaio solo

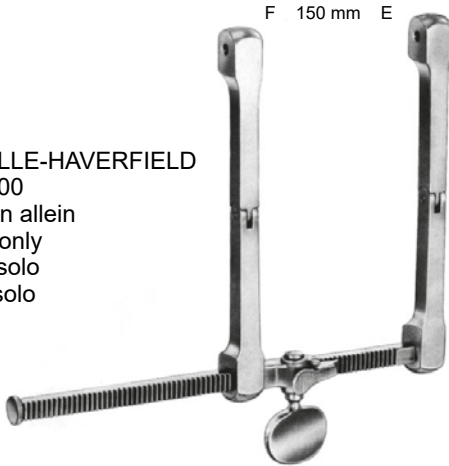

SCOVILLE
19911-00
Rahmen allein
Frame only
Marco solo
Telaio solo

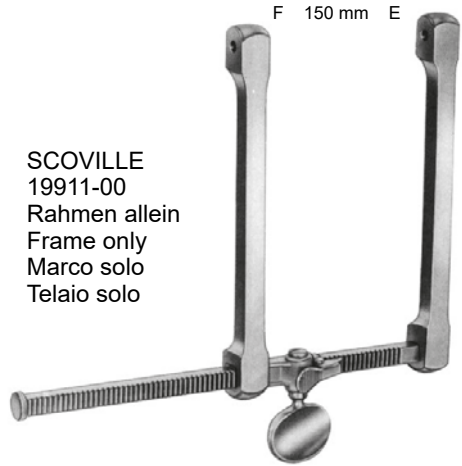

SCOVILLE-HAVERFIELD
19910-01
komplett bestehend aus:
complete consisting of:
completo con:
completo con:
19910-00 + 19913-50 + 19917-64

SCOVILLE
19911-01
komplett bestehend aus:
complete consisting of:
completo con:
completo con:
19911-00 + 19913-50 + 19917-64



SCOVILLE
19912-50
50 mm



SCOVILLE
19912-70
70 mm



SCOVILLE
19914-41 41 x 38 mm
19914-67 67 x 44 mm



TAYLOR
19915-48 48 x 50 mm
19915-64 64 x 50 mm
19916-64 64 x 64 mm
19916-80 80 x 57 mm



SCOVILLE
19913-50
50 mm



SCOVILLE
19913-70
70 mm



SCOVILLE
19917-64 64 x 25 mm
19918-64 64 x 50 mm
19918-88 88 x 25 mm

Laminektomiespreizer
Laminectomy Retractors
Separadores para laminectomia
Divaricatori per laminectomia

62 x 52 mm

62 x 37 mm



19919-02

1 Paar / 1 pair / 1 par / 1 paio



19919-03

47 x 51 mm

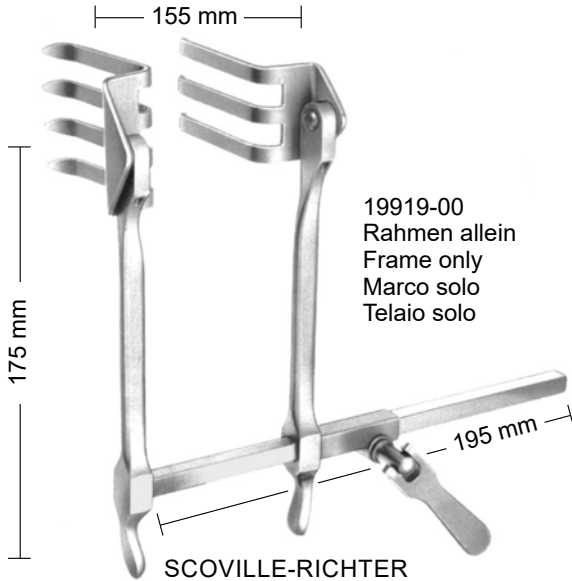

19919-00
Rahmen allein
Frame only
Marco solo
Telaio solo

SCOVILLE-RICHTER
19919-01

komplett / complete / completo / completo



19919-04

30 x 40 mm



19919-05

37 x 62 mm

Rahmen mit 1 Paar Valven 19919-02
frame with one pair of blades 19919-02
marco con 1 par de valvas 19919-02
divaricatore con valve 19919-02

Cervicalspreizer
Cervical Retractor
Separador cervical
Divaricatore cervicale



CLOWARD
25 cm, 10"

spitz
sharp
agudo
acuto

23 mm



15 mm

19710-40	40 x 15 / 23 mm
19710-45	45 x 15 / 23 mm
19710-50	50 x 15 / 23 mm
19710-55	55 x 15 / 23 mm
19710-60	60 x 15 / 23 mm

19710-01
Sperrer, alleine
Retractor, only
Retractor, suelto
Divaricatore solo

19710-00
Sperrer komplett mit 5 Valven spitz
Retractor complete with 5 blades sharp
Separador completo con 5 valvas agudas
Divaricatore completo con 5 valve acute

Cervicalspreizer
 Cervical Retractor
 Separador cervical
 Divaricatore cervicale



CLOWARD
 25 cm, 10"

stumpf
 blunt
 romo
 smusso



19711-40	40 x 15 / 23 mm
19711-45	45 x 15 / 23 mm
19711-50	50 x 15 / 23 mm
19711-55	55 x 15 / 23 mm
19711-60	60 x 15 / 23 mm

19710-01
 Sperrer, alleine
 Retractor, only
 Retractor, suelto
 Divaricatore solo

19712-00
 Sperrer komplett mit 5 Valven stumpf
 Retractor complete with 5 blades blunt
 Separador completo con 5 valvas romas
 Divaricatore completo con 5 valve smusse

Cervicalspreizer
Cervical Retractor
Separador cervical
Divaricatore cervicale

spitz
sharp
agudo
acuto



19710-40	40 x 15 / 23 mm
19710-45	45 x 15 / 23 mm
19710-50	50 x 15 / 23 mm
19710-55	55 x 15 / 23 mm
19710-60	60 x 15 / 23 mm



CLOWARD
16 cm, 6¼"

19711-01
Sperrer, alleine
Retractor, only
Retractor, suelto
Divaricatore solo

19711-00
Sperrer komplett mit 5 Valven spitz
Retractor complete with 5 blades sharp
Separador completo con 5 valvas agudas
Divaricatore completo con 5 valve acute

Cervicalspreizer
 Cervical Retractor
 Separador cervical
 Divaricatore cervicale

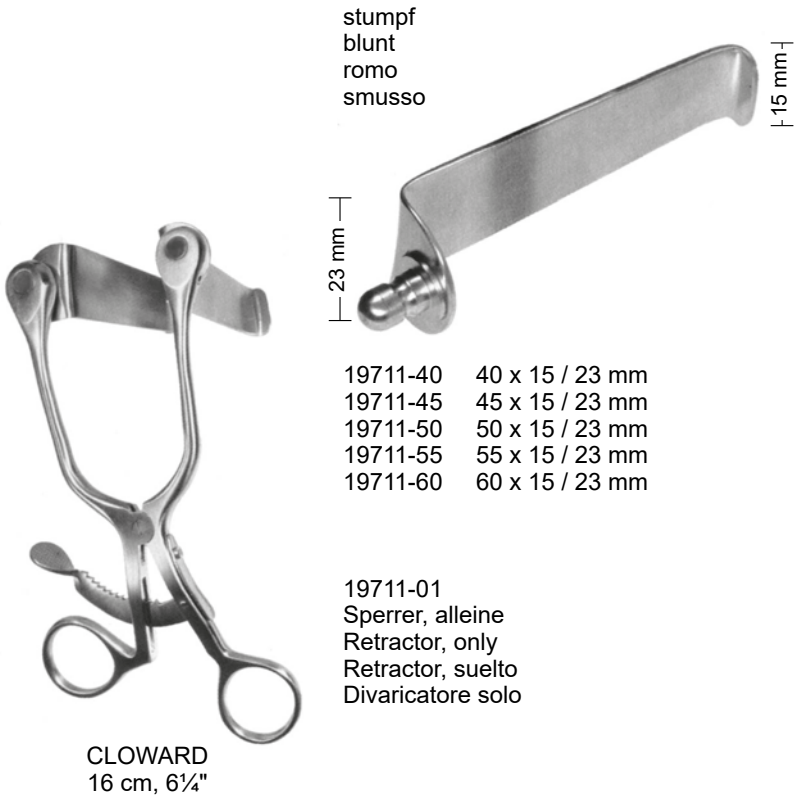

stumpf
 blunt
 romo
 smusso

23 mm

15 mm

- 19711-40 40 x 15 / 23 mm
- 19711-45 45 x 15 / 23 mm
- 19711-50 50 x 15 / 23 mm
- 19711-55 55 x 15 / 23 mm
- 19711-60 60 x 15 / 23 mm

19711-01
 Sperrer, alleine
 Retractor, only
 Retractor, suelto
 Divaricatore solo

CLOWARD
 16 cm, 6¼"

19713-00
 Sperrer komplett mit 5 Valven stumpf
 Retractor complete with 5 blades blunt
 Separador completo con 5 valvas romas
 Divaricatore completo con 5 valve smusse

Cervicalspreizer
Cervical Retractor
Separador cervical
Divaricatore cervicale



90 mm, 3 1/2"

CASPAR
19721-15
165 mm, 5 1/2"

Sperrer, alleine
Retractor, only
Retractor, suelto
Divaricatore solo



19726-01

Blätter-Wechselpinzette
Blade ejector
Pinza para cambiar hojas
Pinze per cambiare valve

19721-00 compl.

5 Valven / 5 blades / 5 valvas / 5 valve

Blätter, stumpf / blunt blades, only stainless steel /

hojas romas de acero inox. / valve smusse di acciaio inox

19738-45 45 x 23 mm

19738-50 50 x 23 mm

19738-55 55 x 23 mm

19738-60 60 x 23 mm

19738-65 65 x 23 mm



Titan Blätter, gefenestert
 Titanium blades, fenestrated
 Valvas de titanio, fenestradas
 Valve de titanio, fenestrata

- 19 mm x 25 mm 19727-25T
- 19 mm x 30 mm 19727-30T
- 19 mm x 35 mm 19727-35T
- 19 mm x 40 mm 19727-40T
- 19 mm x 45 mm 19727-45T
- 19 mm x 50 mm 19727-50T
- 19 mm x 55 mm 19727-55T
- 19 mm x 60 mm 19727-60T

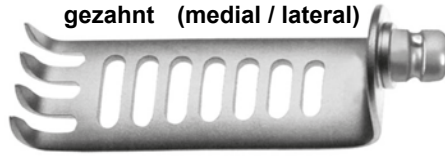

- 19 mm x 25 mm 19728-25T
- 19 mm x 30 mm 19728-30T
- 19 mm x 35 mm 19728-35T
- 19 mm x 40 mm 19728-40T
- 19 mm x 45 mm 19728-45T
- 19 mm x 50 mm 19728-50T
- 19 mm x 55 mm 19728-55T
- 19 mm x 60 mm 19728-60T

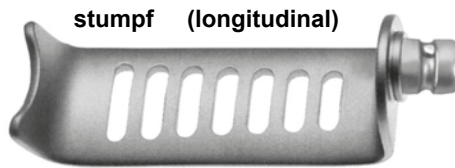

- 24 mm x 30 mm 19729-30T
- 24 mm x 35 mm 19729-35T
- 24 mm x 40 mm 19729-40T
- 24 mm x 45 mm 19729-45T
- 24 mm x 50 mm 19729-50T
- 24 mm x 55 mm 19729-55T
- 24 mm x 60 mm 19729-60T
- 24 mm x 65 mm 19729-65T
- 24 mm x 70 mm 19729-70T

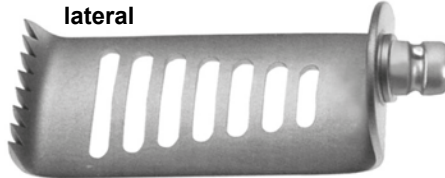

- 24 mm x 30 mm 19730-30T
- 24 mm x 35 mm 19730-35T
- 24 mm x 40 mm 19730-40T
- 24 mm x 45 mm 19730-45T
- 24 mm x 50 mm 19730-50T
- 24 mm x 55 mm 19730-55T
- 24 mm x 60 mm 19730-60T
- 24 mm x 65 mm 19730-65T
- 24 mm x 70 mm 19730-70T

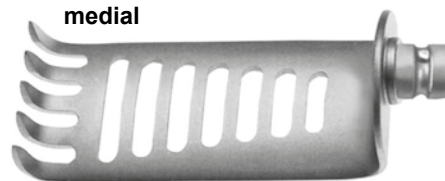

- 24 mm x 35 mm 19731-35T
- 24 mm x 40 mm 19731-40T
- 24 mm x 45 mm 19731-45T
- 24 mm x 50 mm 19731-50T
- 24 mm x 55 mm 19731-55T
- 24 mm x 60 mm 19731-60T
- 24 mm x 65 mm 19731-65T
- 24 mm x 70 mm 19731-70T
- 24 mm x 75 mm 19731-75T

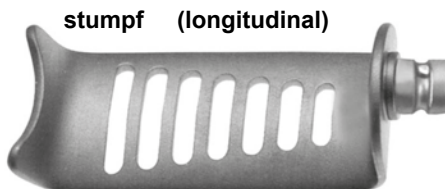

Blätter für Cervicalspreizer
Blades for cervical Retractors
Hojas sueltas para separador cervical
Valve per divaricatori cervicale



19724-55
55 x 20 mm

Blätter, medial / medial blades, only stainless steel /
hojas mediales de acero inox. / valve mediali di acciaio inox

19724-40	40 x 23 mm	19724-55	55 x 23 mm
19724-45	45 x 23 mm	19724-60	60 x 23 mm
19724-50	50 x 23 mm		

Blätter, medial, TITAN / medial blades, only, TITANIUM /
hojas mediales de TITANIO / valve mediali di TITANIO

19732-25 T	25 x 24 mm	19732-50 T	50 x 24 mm
19732-30 T	30 x 24 mm	19732-55 T	55 x 24 mm
19732-35 T	35 x 24 mm	19732-60 T	60 x 24 mm
19732-40 T	40 x 24 mm	19732-65 T	65 x 24 mm
19732-45 T	45 x 24 mm	19732-70 T	70 x 24 mm



19734-50
50 x 23 mm

Blätter, lateral / lateral blades, only stainless steel /
hojas laterales de acero inox. / valve laterali di acciaio inox

19725-40	40 x 23 mm	19725-55	55 x 23 mm
19725-45	45 x 23 mm	19725-60	60 x 23 mm
19725-50	50 x 23 mm		

Blätter, lateral, TITAN / lateral blades, only, TITANIUM /
hojas laterales de TITANIO / valve laterali di TITANIO

19736-25 T	25 x 24 mm	19736-50 T	50 x 24 mm
19736-30 T	30 x 24 mm	19736-55 T	55 x 24 mm
19736-35 T	35 x 24 mm	19736-60 T	60 x 24 mm
19736-40 T	40 x 24 mm	19736-65 T	65 x 24 mm
19736-45 T	45 x 24 mm	19736-70 T	70 x 24 mm

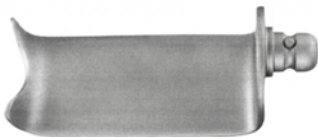

19738-55
55 x 23 mm

Blätter, stumpf / blunt blades, only stainless steel /
hojas romas de acero inox. / valve smusse di acciaio inox

19738-45	45 x 23 mm	19738-60	60 x 23 mm
19738-50	50 x 23 mm	19738-65	65 x 23 mm
19738-55	55 x 23 mm		

Blätter, stumpf, TITAN / blunt blades, only, TITANIUM /
hojas romas de TITANIO / valve smusse di TITANIO

19739-30 T	30 x 24 mm	19739-55 T	55 x 24 mm
19739-35 T	35 x 24 mm	19739-60 T	60 x 24 mm
19739-40 T	40 x 24 mm	19739-65 T	65 x 24 mm
19739-45 T	45 x 24 mm	19739-70 T	70 x 24 mm
19739-50 T	50 x 24 mm	19739-75 T	75 x 24 mm



Blätter, stumpf / blunt blades, only stainless steel /
hojas romas de acero inox. / valve smusse di acciaio inox

19740-50	50 x 25 mm
19740-60	60 x 25 mm

Hemilaminectomie Spreizer
 Hemilaminectomy Retractor
 Separadores para hemilaminectomía
 Divaricatori per emilaminectomia

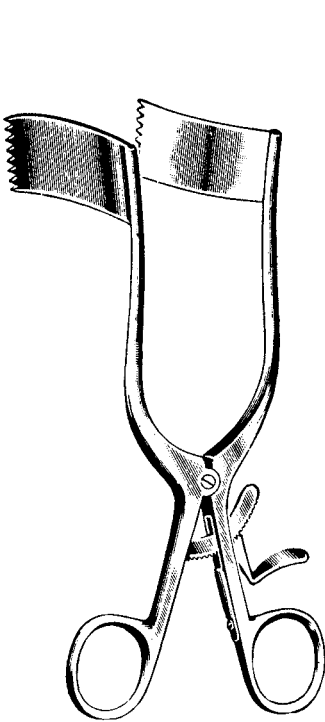

MEYERDING
 17 cm, 6¾"
 19748-01 2,5 x 3,2 cm
 19748-02 2,5 x 5,4 cm
 19748-03 1,9 x 6,0 cm
 19748-04 2,5 x 6,0 cm

25 x 50 mm



MARKHAM-MEYERDING
 19749-01
 18 cm, 7"

25 x 50 mm



MARKHAM-MEYERDING
 19749-02
 18 cm, 7"

Hemilaminectomie Spreizer
 Hemilaminectomy Retractor
 Separadores para hemilaminectomía
 Divaricatori per emilaminectomia



WILLIAMS
 20 cm, 8"

- | | |
|------------|----------------|
| 50 x 10 mm | 19750-01 |
| 60 x 10 mm | 19750-02 |
| 70 x 10 mm | 19750-03 |
| 50 x 20 mm | 19750-04 |
| 60 x 20 mm | 19750-05 |
| 70 x 20 mm | 19750-06 |
| | links |
| | left |
| | a la izquierda |
| | a sinistra |

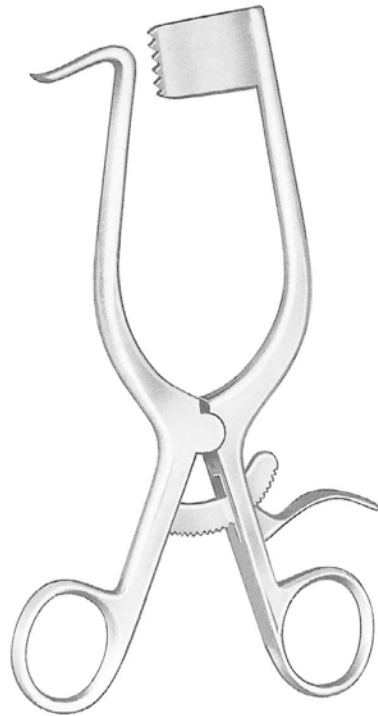

WILLIAMS
 20 cm, 8"

- | | |
|------------|--------------|
| 50 x 10 mm | 19751-01 |
| 60 x 10 mm | 19751-02 |
| 70 x 10 mm | 19751-03 |
| 50 x 20 mm | 19751-04 |
| 60 x 20 mm | 19751-05 |
| 70 x 20 mm | 19751-06 |
| | rechts |
| | right |
| | a la derecha |
| | a destra |

Wundspreizer
Retractors
Separadores
Divaricatori



GELPI

19802-09	9 cm, 3½"
19802-11	11 cm, 4¾"
19802-14	14 cm, 5½"
19802-16	16 cm, 6¼"
19802-18	18 cm, 7"

Lamina Spreizer
Lamina Retractor
Separadores para vertebrales
Separatori per vertebre



CLOWARD
41401-16
16 cm, 6¼"

Lamina Spreizer
Lamina Retractor
Separadores para vertebrales
Separatori per vertebre

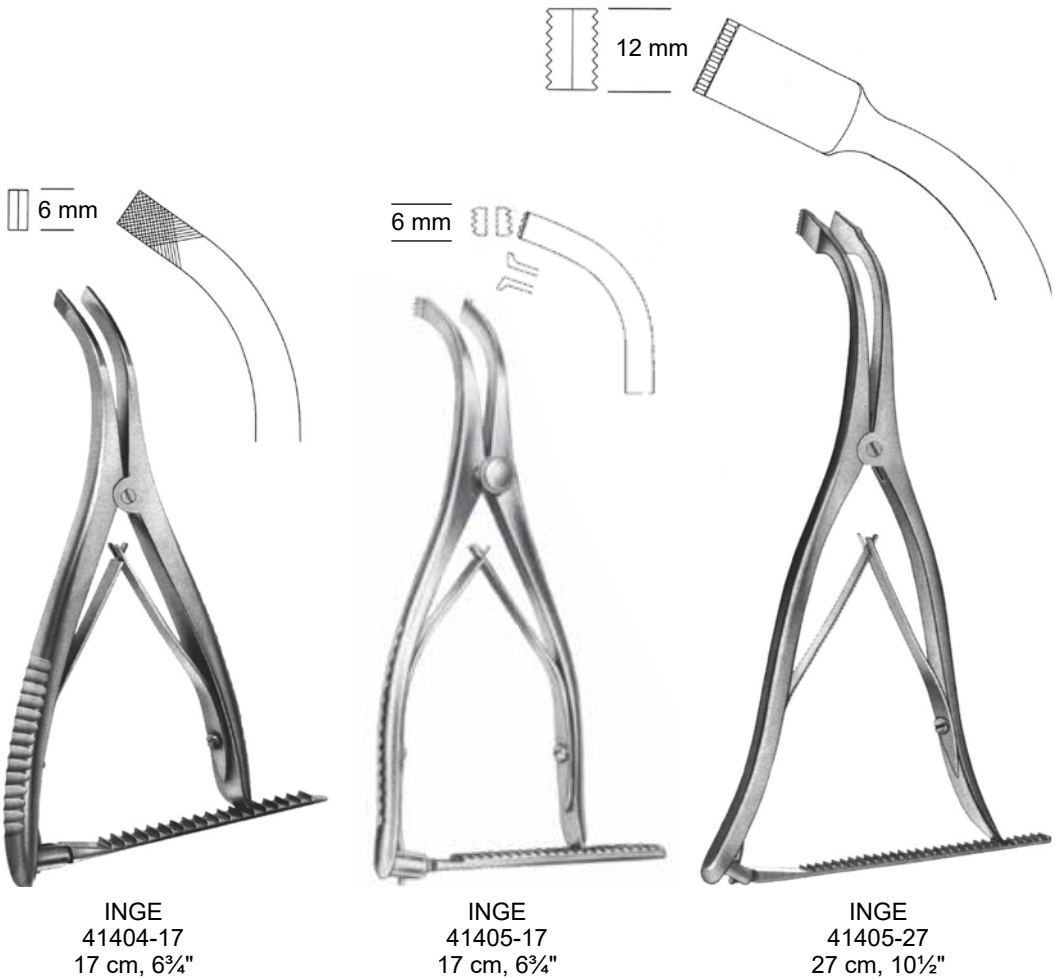

Lamina Spreizer
Lamina Retractor
Separadores para vertebrales
Separatori per vertebre

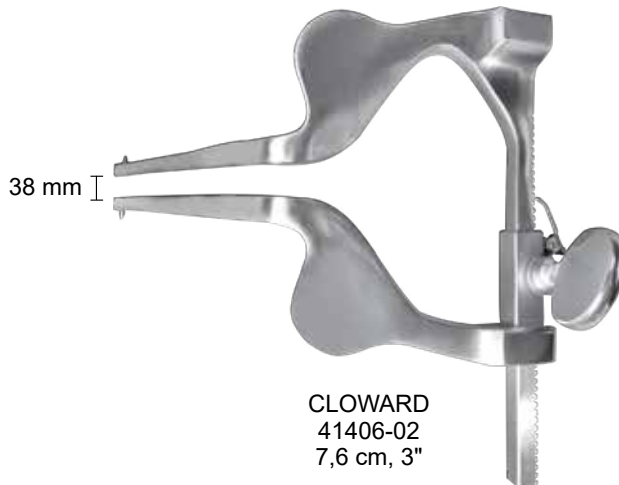

Lumbal-Wundspreizer
Lumbal Retractors
Separadores lumbales autoestáticos
Divaricatori autostatici lombari



19745-40
40 mm, 1½"



19745-45
45 mm, 1¾"



19745-60
60 mm, 2¼"



19745-50
50 mm, 2"



19745-65
65 mm, 2½"



19745-55
55 mm, 2⅛"



19745-70
70 mm, 2¾"

CASPAR
19744-00
compl. incl. 7 Blätter
compl. incl. 7 blades
completo con 7 valvas
complete di 7 valve

19744-17
ohne Blätter
without blades
sin valvas
senza valve

Spekula für lumbale Bandscheibenoperationen
Specula for lumbar operations
Especulas para operaciones lumbales
Specolo per ernia discale lombare



CASPAR

19748-40	40 mm / 1½"
19748-45	45 mm / 1¾"
19748-50	50 mm / 2"
19748-55	55 mm / 2⅛"
19748-60	60 mm / 2¼"
19748-65	65 mm / 2½"
19748-70	70 mm / 2¾"
19748-75	75 mm / 3"
19748-85	85 mm / 3¼"



Lumbal-Wundspreizer
 Lumbal Retractors
 Separadores lumbales autoestáticos
 Divaricatori autostatici lombari

19726-01 Blätter-Wechselpinzette
 Blade ejector
 Pinza para cambiar hojas
 Pinze per cambiare valve



60 mm

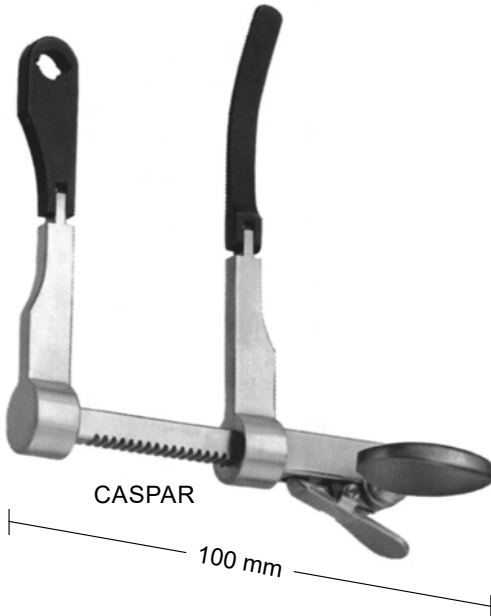

CASPAR

100 mm

19742-35 35 mm
 19742-40 40 mm
 19742-45 45 mm
 19742-50 50 mm
 19742-55 55 mm
 19742-60 60 mm



Valven, lateral / blades, lateral
 valvas, laterales / valve, laterali

19930-00 Gegensperrer, komplett mit 6 Blättern
 Counter Retractor, complete with 6 blades
 Contra-retractor, completo, con 6 hojas
 Divaricatore completo di 6 valve

19930-01 Gegensperrer, alleine
 Counter Retractor, only
 Contra-retractor, suelto
 Divaricatore solo

Lumbal-Wundspreizer
Lumbal Retractors
Separadores lumbal
Divaricatore lombare



19742-35	35 mm / 1¼"
19742-40	40 mm / 1½"
19742-45	45 mm / 1¾"
19742-50	50 mm / 2"
19742-55	55 mm / 2⅛"
19742-60	60 mm / 2¼"
19742-65	65 mm / 2½"
19742-75	75 mm / 3"
19742-85	85 mm / 3¼"

Blätter alleine, lateral
blades only, lateral
hojas sueltas, lateral
valve sole, laterale



19743-35	35 mm / 1¼"
19743-40	40 mm / 1½"
19743-45	45 mm / 1¾"
19743-50	50 mm / 2"
19743-55	55 mm / 2⅛"
19743-60	60 mm / 2¼"
19743-65	65 mm / 2½"

Blätter alleine, medial
blades only, medial
hojas sueltas, medial
valve sole, mediali

Cervicales Wirbelkörper Distraktions System
Cervical Vertebral Body Distraction System
Cervical Sistema de distracción vertebral
Sistema di distrazione vertebrale cervicale



19920-01 Distraktor alleine, rechts
Distractor only, right
Distractor suelto, lado derecho
Distrattore solo, a destra

19920-02 Distraktor alleine, links
Distractor only, left
Distractor suelto, lado izquierdo
Distrattore solo, a sinistra

19930-03 Distraktor alleine, rechts mit verlängerter Führungsstange für mehrere Distraktionen
Distractor only, right with elongated toothed bar for multilevel distraction
Distractor suelto, lado derecho, con guía alargada para distracciones multiples
Distrattore solo, a destra, allungato, per multi-distrazioni

19930-02 Distraktor alleine, links
Distractor only, left
Distractor suelto, lado izquierdo
Distrattore solo, a sinistra

Cervicales Wirbelkörper Distraktions System
Cervical Vertebral Body Distraction System
Cervical Sistema de distracción vertebral
Sistema di distrazione vertebrale cervicale



19940-01

19940-01
Bohrlehre, rechts, für Distraktor 19920-01 + 19930-01
Drill guide, right, for distractor 19920-01 + 19930-01
Guía, lado derecho, para distractor 19920-01 + 19930-01
Guida a destra per distrattore 19920-01 + 19930-01

19940-02
Bohrlehre, links, für Distraktor 19920-02 + 19930-02
Drill guide, left, for distractor 19920-02 + 19930-02
Guía, lado izquierdo, para distractor 19920-02 + 19930-02
Guida a sinistra per distrattore 19920-02 + 19930-02

Wirbelkörper Distraktions System
 Vertebral Body Distraction System
 Sistema de distracción vertebral
 Sistema di distrazione vertebrale



Bohrer Ø 1,7 mm
 für Distraktionsschrauben
 Bohrtiefe 8 mm
 Twist drill Ø 1,7 mm
 for distraction screws
 drilling depth: 8 mm
 perforador Ø 1,7 mm
 para tornillos de distracción
 profundidad de 8 mm
 perforatore Ø 1,7 mm
 per viti di distrazione
 profondità 8 mm

19950-14
 145 mm
 5¾"



Schraubendreher
 für Distraktionsschrauben
 Screw driver
 for distraction screws
 Atornillador
 para tornillos de distracción
 Cacciavite
 per viti di distrazione

19960-20
 200 mm
 8"



19970-12 12 mm
 19970-14 14 mm
 19970-16 16 mm
 19970-18 18 mm

Distraktionsschrauben
 Distraction screws
 Tornillos de distracción
 Vite distrattore

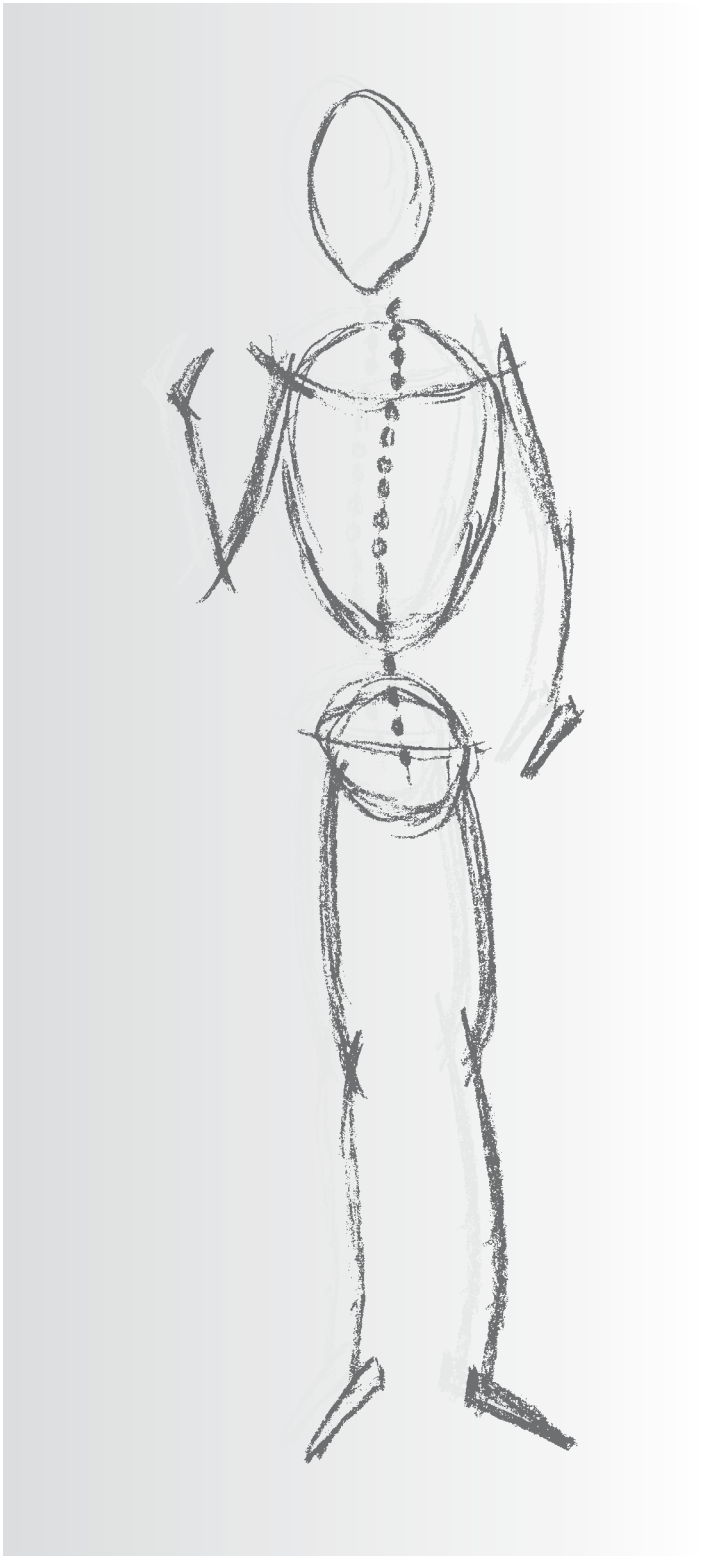

Reda Instrumente GmbH
Gänsäcker 34 - P.O. Box 131
D-78532 Tuttlingen

ZANGEN

FORCEPS

PINZAS

PINZE

Hohlmeißelzangen
 Bone Rongeurs
 Pinzas-gubias
 Pinze sgorbie

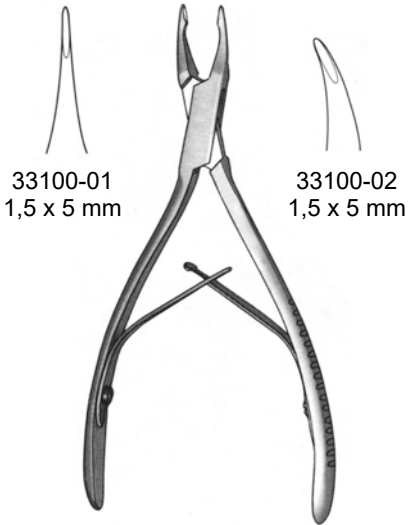

MICRO FRIEDMAN
 14 cm, 5½"



FRIEDMAN Mini
 33101-12 12 cm, 4¾"



FRIEDMAN
 33101-14 14 cm, 5½"

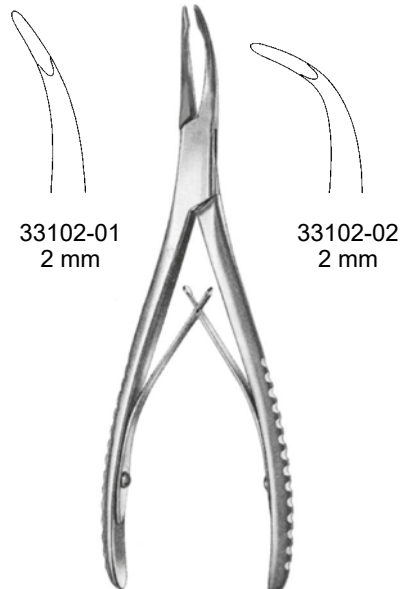

STELLBRINK
 17 cm, 6¾"

Hohlmeißelzangen
 Bone Rongeurs
 Pinzas-gubias
 Pinze sgorbie



4,5 mm

LUER
 33131-15 15 cm, 5.9"

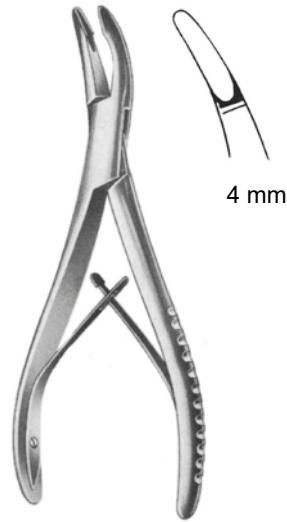

4 mm

LUER
 33133-15 15 cm, 5.9"

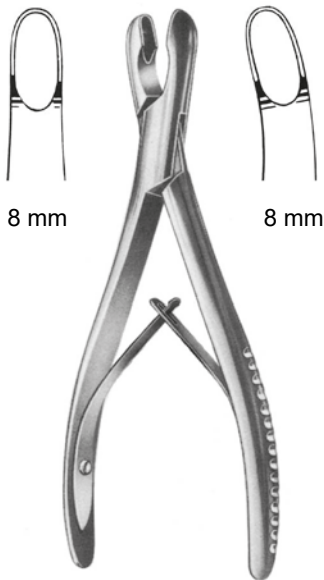

8 mm

8 mm

LUER
 33136-17 33137-17
 17 cm, 6 3/4"



9 mm

ADSON
 33142-20 33143-20
 20 cm, 7.9"

Hohlmeißelzangen
 Bone Rongeurs
 Pinzas-gubias
 Pinze sgorbie

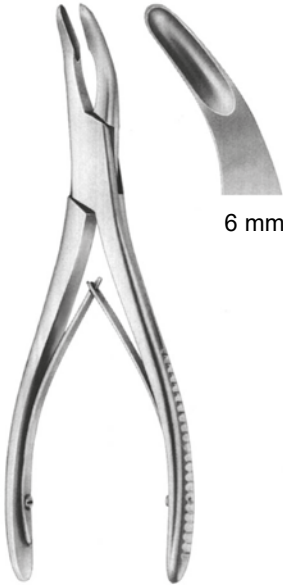

6 mm

OLIVECRONA
 33147-20 20 cm, 7.9"

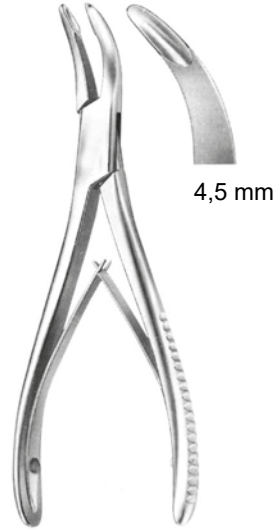

4,5 mm

BANE-HARTMANN
 33148-18 17,5 cm, 7"



3 mm

— LEMPERT —
 33150-16 33151-16
 16 cm, 6¼"



5 mm

— JANZEN —
 33152-17 33153-17
 17 cm, 6¾"

Hohlmeißelzangen
 Bone Rongeurs
 Pinzas-gubias
 Pinze sgorbie



— LEMPERT —
 33154-18 33155-18
 18,5 cm, 7¼"



BEYER
 33156-18
 18 cm, 7"

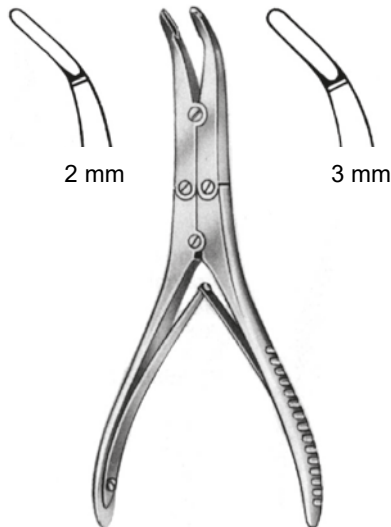

KLEINERT-KUTZ
 33157-02 33157-03
 15 cm, 6"

Hohlmeißelzangen
 Bone Rongeurs
 Pinzas-gubias
 Pinze sgorbie



SMITH-PETERSEN
 24 cm, 9½"

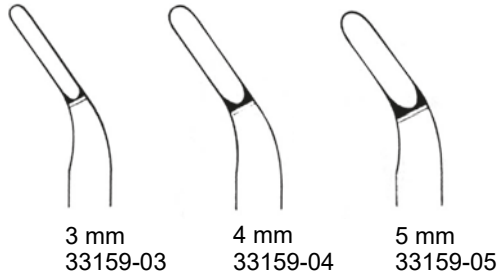
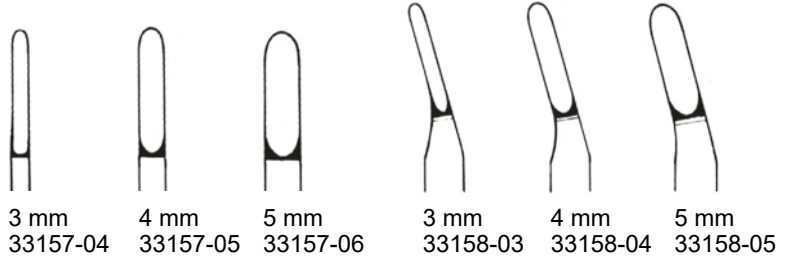

BACON
 33159-20
 20 cm, 8"

Hohlmeißelzangen
 Bone Rongeurs
 Pinzas-gubias
 Pinze sgorbie



BEYER
 33201-18
 18 cm, 7"



MAYFIELD
 33202-18
 18 cm, 7"



ZAUFAL-JANSEN
 33205-18
 18 cm, 7"



— BÖHLER —
 33211-15 33213-15
 15 cm, 6"

Hohlmeißelzangen
Bone Rongeurs
Pinzas-gubias
Pinze sgorbie

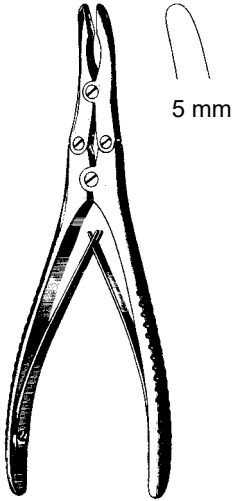

— RUSKIN —
33216-18 33217-18
18 cm, 7"

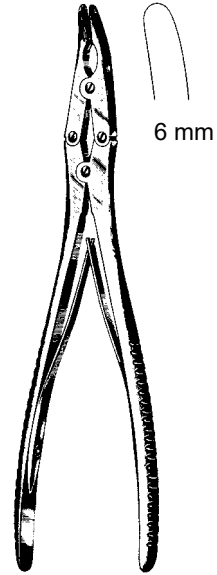

RUSKIN
33219-23 23 cm, 9"



MARQUARDT
33220-20 20 cm, 8"

Hohlmeißelzangen
 Bone Rongeurs
 Pinzas-gubias
 Pinze sgorbie

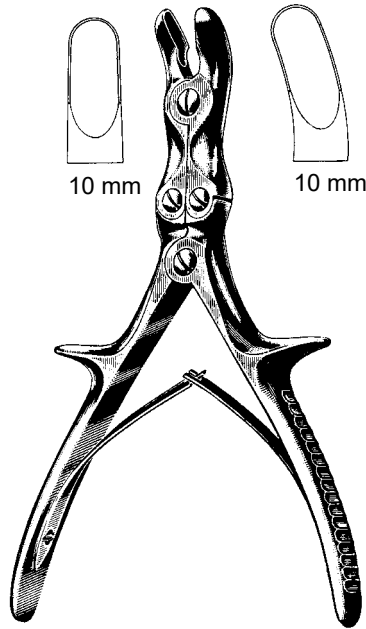

STILLE-LUER
 33230-22 22 cm, 8³/₄" 33231-22
 33230-26 26 cm, 10¹/₄" 33231-26

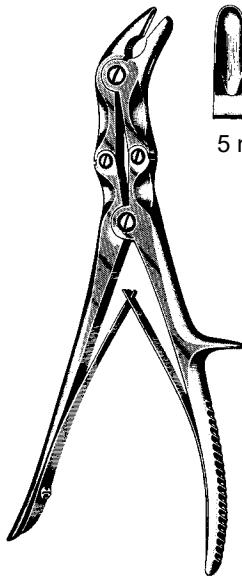

STILLE-LUER
 33235-23
 23 cm, 9"

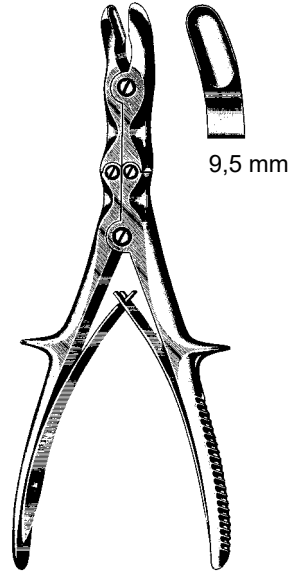

STILLE-RUSKIN
 33237-23
 23 cm, 9"

Hohlmeißelzangen
Bone Rongeurs
Pinzas-gubias
Pinze sgorbie

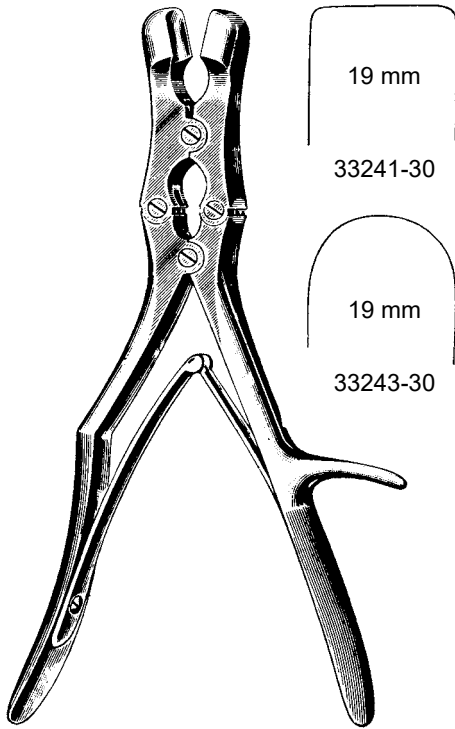

SAUERBRUCH
30 cm, 11 $\frac{3}{4}$ "

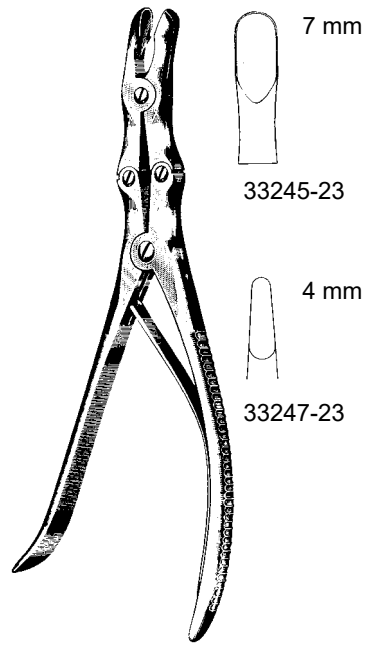

LEKSELL (STILLE)
23 cm, 9"

Hohlmeißelzangen
 Bone Rongeurs
 Pinzas-gubias
 Pinze sgorbie



ECHLIN
 23 cm, 9"



33257-23 2 mm



33258-23 3 mm



33259-23 4 mm



FRYKHOLM
 33260-24
 24 cm, 9½"



4,5 mm



SEMB
 33261-22
 22,5 cm, 8.9"



17 mm

Knochensplitterzangen
 Bone Cutting Forceps
 Pinzas cortantes para huesos
 Cesoie per ossa

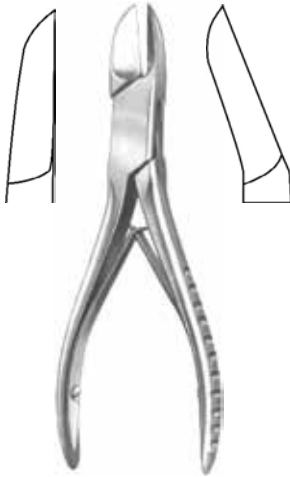

— LISTON —

33274-14 14 cm, 5½" 33275-14
 33274-17 17 cm, 6¾" 33275-17
 33274-19 19 cm, 7½" 33275-19



— BÖHLER —

33280-15 33281-15
 15 cm, 6"



COTTLE-KAZANJIAN

33282-19
 19 cm, 7½"



MC INDOE
 33283-17
 17 cm, 6¾"



STAMM
 33284-15
 15 cm, 6"



— RUSKIN-LISTON —
 33286-18 33289-18
 18 cm, 7"

Knochensplitterzangen
 Bone Cutting Forceps
 Pinzas cortantes para huesos
 Cesioie per ossa

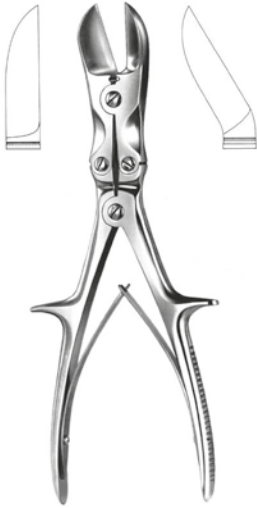

— STILLE-LISTON —
 33290-23 23 cm, 9" 33291-23
 33290-27 27 cm, 10½" 33291-27



STILLE-LISTON
 33292-26
 26 cm, 10¼"



STILLE-HORSLEY
 33293-27
 27 cm, 10½"



SEMB
 33295-24
 24 cm, 9½"

Anlegezangen, Klammerblock
 Applying Forceps, Clip Rack
 Pinzas aplicadoras, riel para grapas
 Pinza per applicare, porta-fermagli

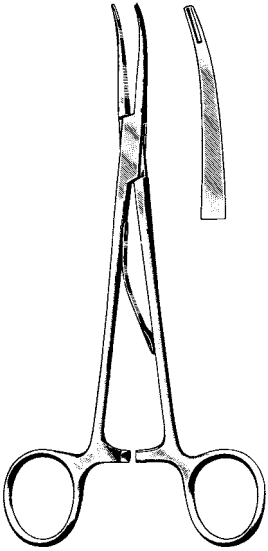

McKENZIE

41011-15 15 cm, 6"
 41011-19 19 cm, 7½"

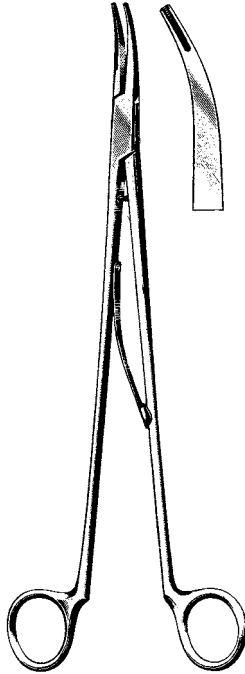

SMITHWICK

41015-23 23 cm, 9"
 41015-26 26 cm, 10¼"

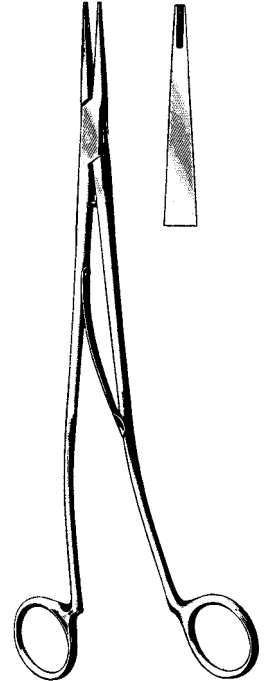

SWEET

41017-23 23 cm, 9"
 41017-26 26 cm, 10¼"

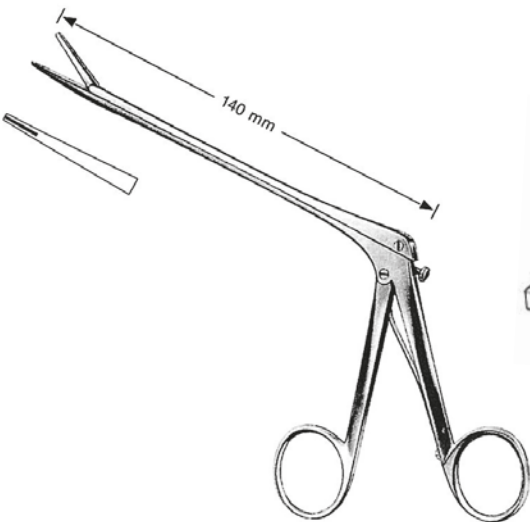

OLIVECRONA-TOENNIS
 41019-14

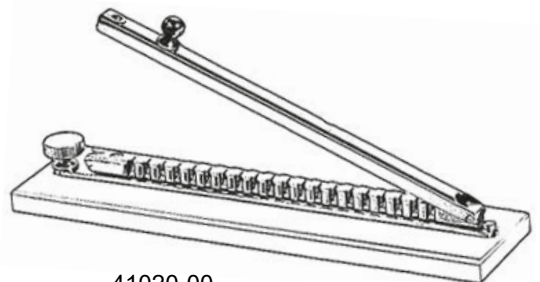

41020-00
 148 x 40 x 6 mm

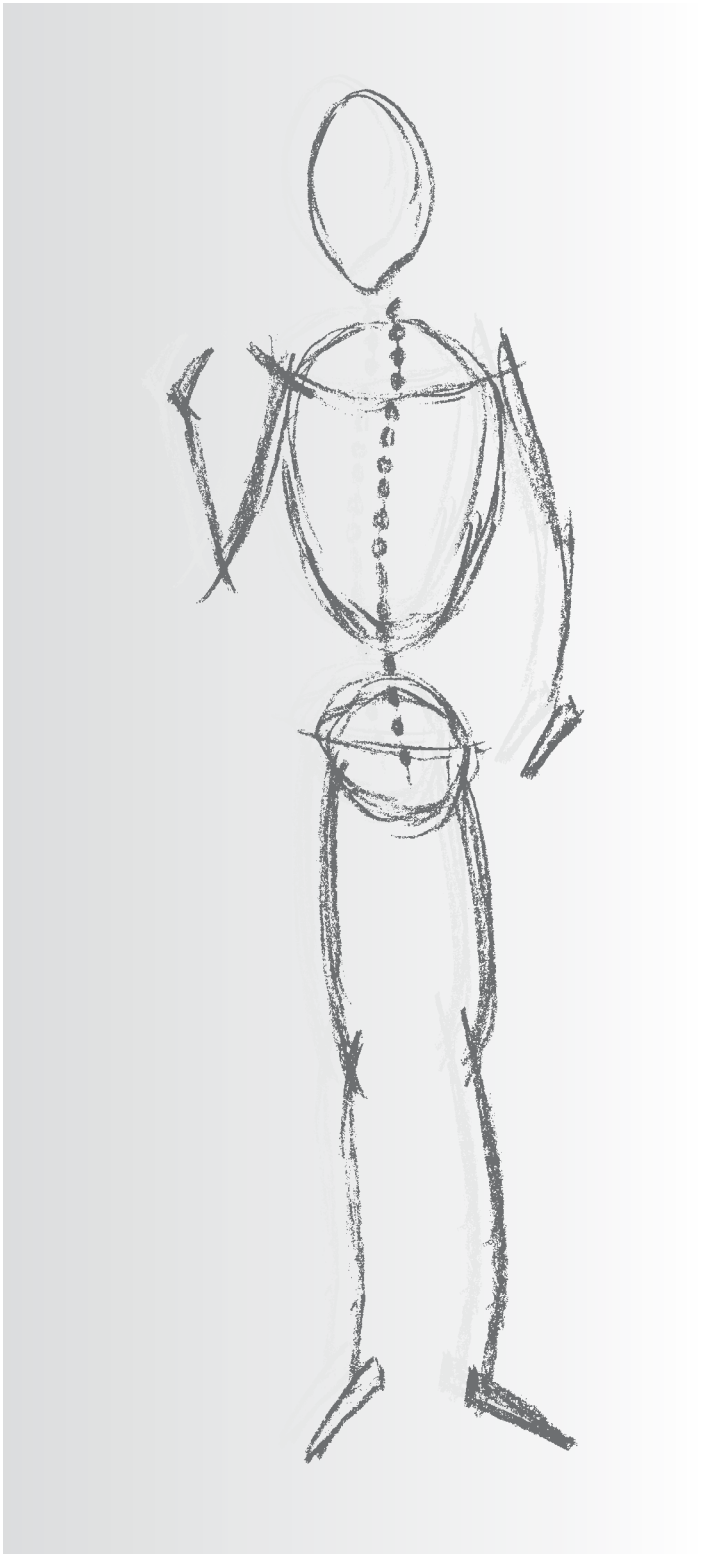

Reda Instrumente GmbH
Gänsäcker 34 - P.O. Box 131
D-78532 Tuttlingen

**SCHÄDELHALTER
DRAHTSÄGEN
TREPHINEN**

**SKULL HOLDER
WIRE SAWS
TREPHINE**

**CRÁNEO TITULAR
ALAMBRE DE SIERRAS
TREPANO**

**SKULL TITOLARE
SEGHE A FILO
TRAPANO**

Schädelhalter, Kopfhautklammer, Anlegezange
Cervical Traction Tongs, Clips, Applying Forceps
Pinzas de tracción craneal, Clips, pinza aplicadora para clips
Arco per trazione craniale, Pinza applicatrice

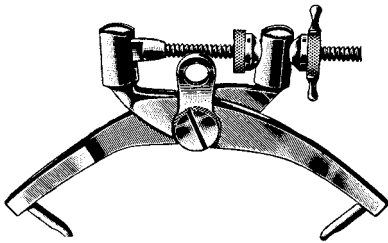

CRUTCHFIELD
41025-01



CRUTCHFIELD
41025-02



41026-35
3,5 mm Ø



41026-50
5 mm Ø

Stainless steel
Acciaio inox
acero inoxidable



RANEY
41027-00

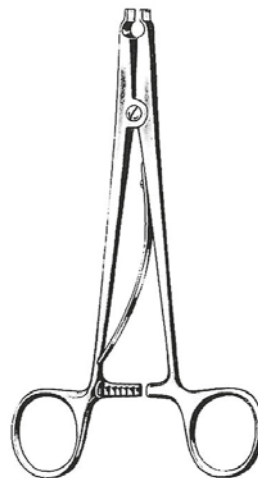

RANEY
41028-00 16 cm, 6¼"

Drahtsägen, Einführungsinstrument
 Wire Saws, Guiding Instruments
 Sierras de hilo de metal, Instrumentos para su introducción
 Seghe di filo d'acciaio, Strumenti introduttori



DeMARTEL
 41090-33
 33 cm, 13"

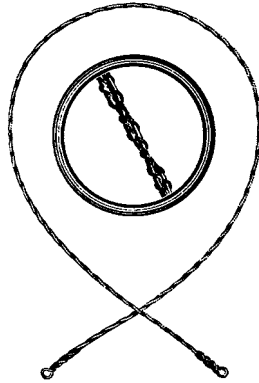

OLIVECRONA	cm
41092-30	30, 11¾"
41092-40	40, 15¾"
41092-50	50, 19¾"
41092-60	60, 23¾"
41092-70	70, 27½"



GIGLI STRULLY
 41093-00



GIGLI
 41094-00

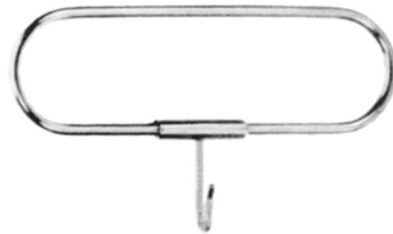

REDA
 41095-00

Schädelzange
Skull Punches
Pinzas sacabocado craneal
Pinza per craniotomia



DeVILBISS
41096-21
21 cm, 8¼"

Schädelstanze
Cranial Punch
Pinzas sacabocado craneal
Pinza per craniotomia



CONE
41097-22
22,5 cm, 9"

Bohrloch-Schutzzange
Bore hole protection Forceps
Pinzas para la protección de orificio
Pinze per la protezione del foro



41098-20
20,5 cm, 8"

Schädeltrephine
Skull Trepine
Trépanos craneales
Trapano cranico

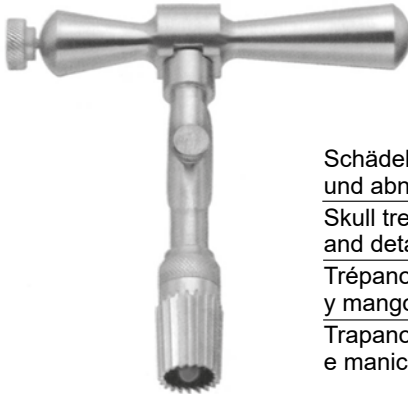

Schädeltrephine mit verstellbarem Dorn
und abnehmbarem Quergriff

Skull trephines with adjustable centering point
and detachable cross-bar handle

Trépano craneal con guía-central ajustable
y mango transversal desmontable

Trapano cranico con punta regolabile
e manico trasversale smontabile

GALT

34816-13 Ø 13 mm

34816-16 Ø 16 mm

34816-19 Ø 19 mm

Bohrlochzange
Drill Guide and Dura Protecting Forceps
Pinza guía taladros y protectora de duramadre
Pinze guida-perforatore e proteggi dura-madre

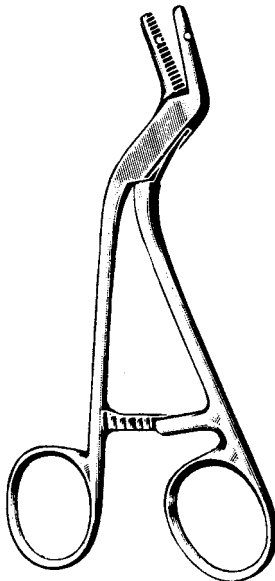

ADSON
34231-15
15 cm, 6"

Trepine
Trepine
Trepano
Punta trapano

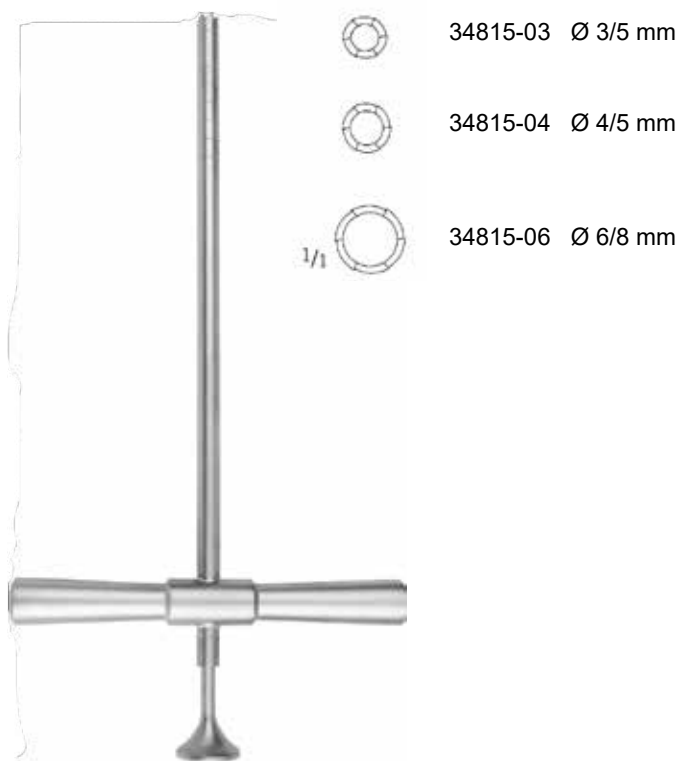

MICHELE

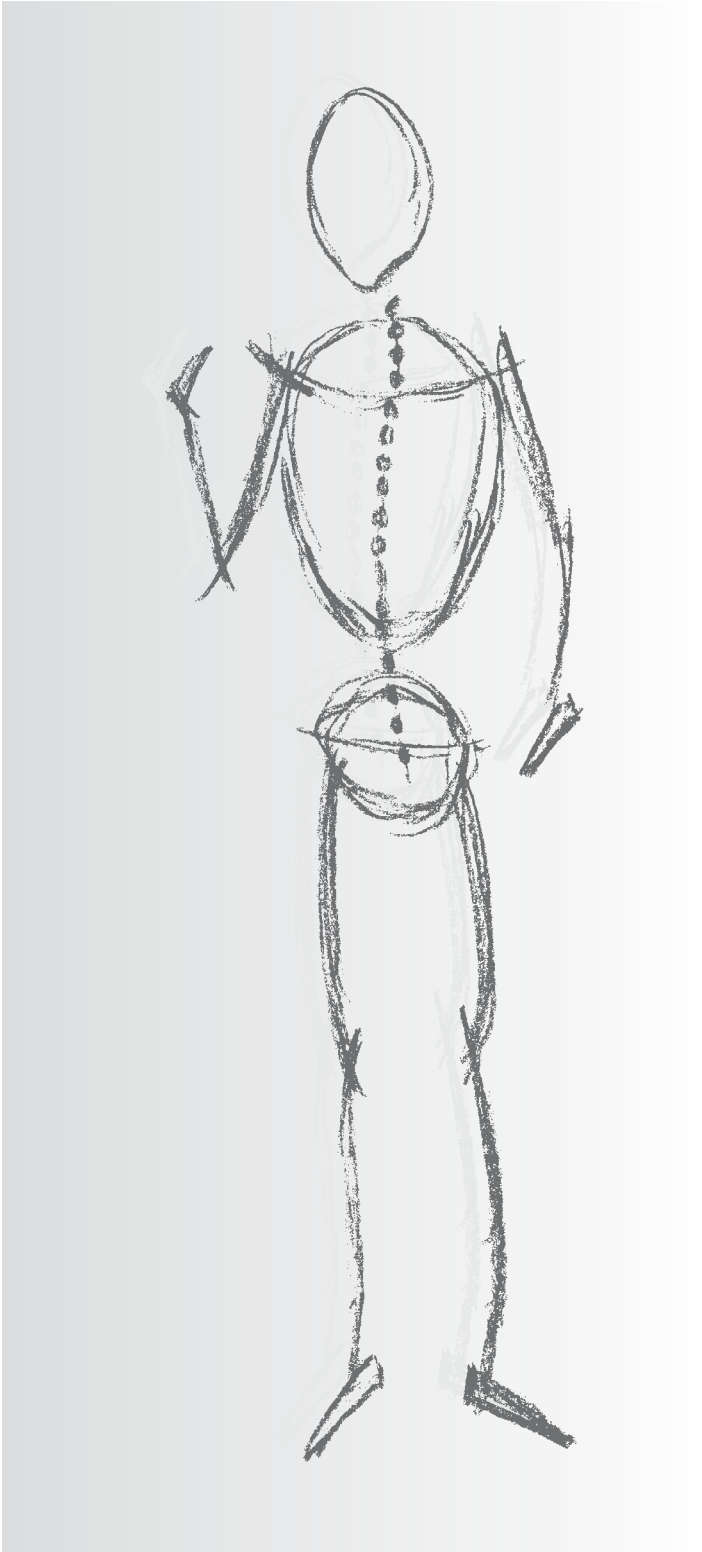

Reda Instrumente GmbH
Gänsäcker 34 - P.O. Box 131
D-78532 Tuttlingen

LÖFFEL, MEISSEL

CURETTES, CHISELS

CUCHARILLAS, CINCELES

CUCCHIAI, SCALPELLI

Scharfe Löffel
 Bone Curettes
 Cucharillas cortantes
 Curette taglienti

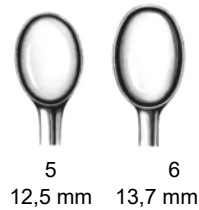
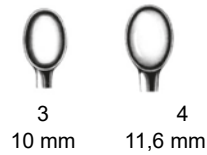
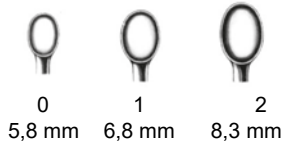

Fig.	
0000	33469-96
000	33469-97
00	33469-98
0	33470-00
1	33470-01
2	33470-02
3	33470-03
4	33470-04
5	33470-05
6	33470-06

VOLKMANN
 17 cm, 6¾"

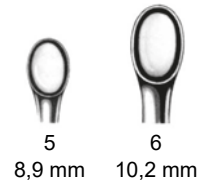
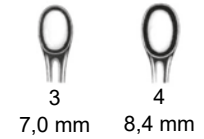
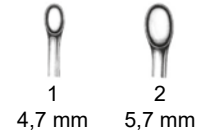
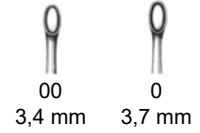
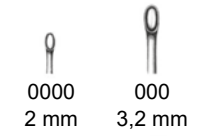

Fig.	
0000	33474-96
000	33474-97
00	33474-98
0	33475-00
1	33475-01
2	33475-02
3	33475-03
4	33475-04
5	33475-05
6	33475-06

SPRATT
 17 cm, 6¾"

Scharfe Löffel
Bone Currettes
Cucharillas cortantes
Curette taglienti



COBB
27,9 cm, 11"

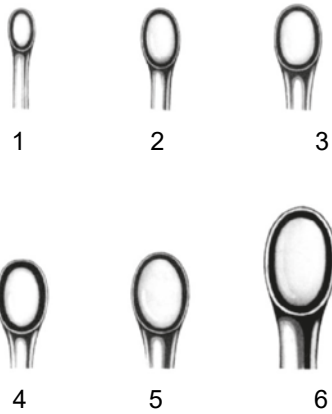
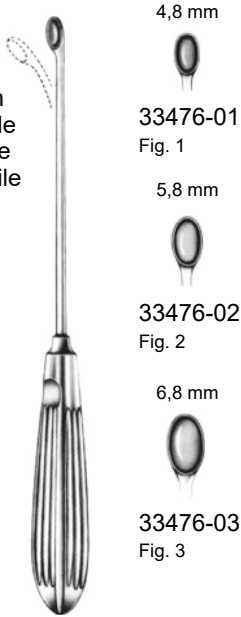

Fig.

1	33473-01	3,5 mm
2	33473-02	4,5 mm
3	33473-03	5,5 mm
4	33473-04	7,5 mm
5	33473-05	8,5 mm
6	33473-06	10,0 mm

Scharfe Löffel
 Bone Currettes
 Cucharillas cortantes
 Curette taglienti

biegsam
 malleable
 maleable
 malleabile



HALLÉ
 21 cm, 8¼"



SPINAL
 20 cm, 8"

Fig.		
000	33476-98	2,8 mm
00	33476-99	3,3 mm
0	33477-00	3,7 mm
1	33477-01	4,3 mm
2	33477-02	4,8 mm
3	33477-03	5,6 mm
4	33477-04	6,1 mm
5	33477-05	6,7 mm
6	33477-06	8,8 mm

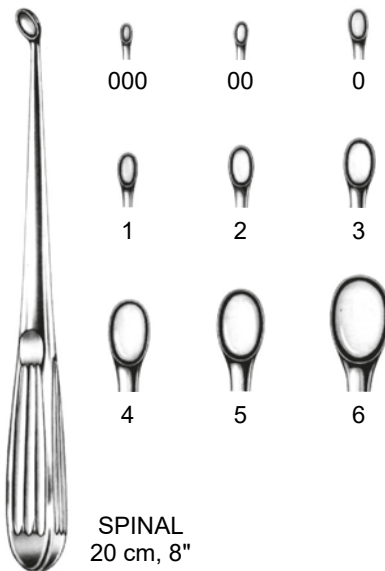

SPINAL
 20 cm, 8"

Fig.		
000	33478-98	2,8 mm
00	33478-99	3,3 mm
0	33479-00	3,7 mm
1	33479-01	4,3 mm
2	33479-02	4,8 mm
3	33479-03	5,6 mm
4	33479-04	6,1 mm
5	33479-05	6,7 mm
6	33479-06	8,8 mm

Scharfe Löffel
Bone Curettes
Cucharillas cortantes
Curette taglienti

gezahnt
toothed
dentada
dentate

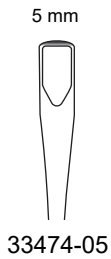
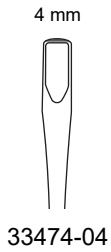

CASPAR
25 cm, 9³/₄"

gezahnt
toothed
dentada
dentate

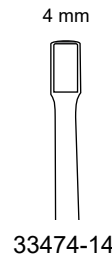
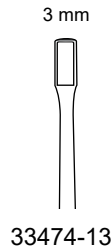

CASPAR
27 cm, 10³/₄"

4,7 mm



33482-01

4,7 mm



33482-02

4,7 mm



33482-03



SCOVILLE
25 cm, 9³/₄"

Scharfe Löffel
 Bone Curettes
 Cucharillas cortantes
 Curette taglianti



BRUNS
 23 cm, 9"



BRUNS
 23 cm, 9"



BRUNS
 23 cm, 9"

Fig.

000	33480-97	2,0 mm	33482-97	2,8 mm	33484-97	2,8 mm
00	33480-98	2,5 mm	33482-98	3,3 mm	33484-98	3,3 mm
0	33481-00	3,3 mm	33483-00	3,7 mm	33485-00	3,7 mm
1	33481-01	3,8 mm	33483-01	4,3 mm	33485-01	4,3 mm
2	33481-02	4,8 mm	33483-02	4,8 mm	33485-02	4,8 mm
3	33481-03	5,3 mm	33483-03	5,6 mm	33485-03	5,6 mm
4	33481-04	6,0 mm	33483-04	6,1 mm	33485-04	6,1 mm
5	33481-05	6,7 mm	33483-05	6,7 mm	33485-05	6,7 mm
6	33481-06	7,3 mm	33483-06	8,8 mm	33485-06	8,8 mm

Scharfe Löffel
 Bone Curettes
 Cucharillas cortantes
 Curette taglienti

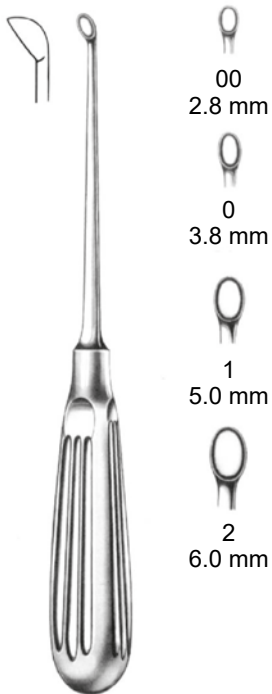

DAUBENSPECK
 20 cm, 8"

- Fig. 00 33487-99
 0 33488-00
 1 33488-01
 2 33488-02

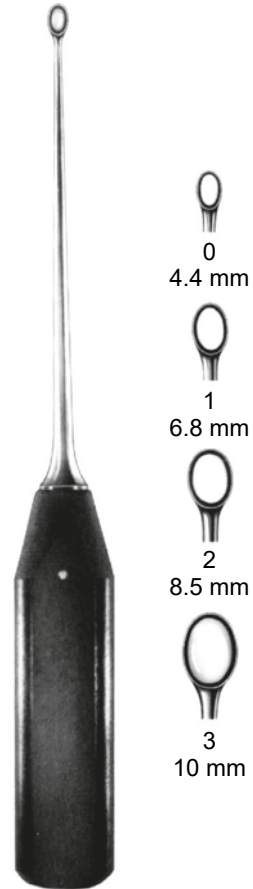

27 cm, 10½"

- Fig. 0 33489-00
 1 33489-01
 2 33489-02
 3 33489-03

Scharfe Löffel
 Bone Currettes
 Cucharillas cortantes
 Curette taglienti

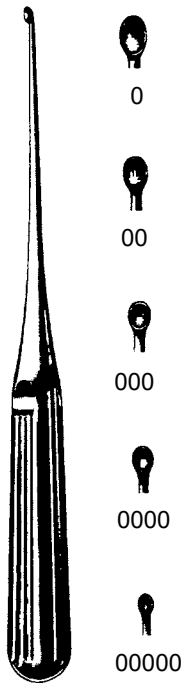

LEMPERT
 17,5 cm, 7"

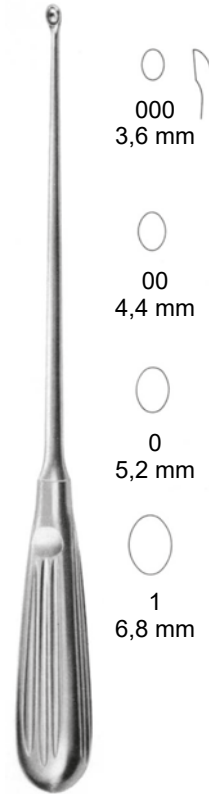

REDA
 25 cm, 10"

Fig. 0	33490-10	3,3 mm
00	33490-20	3,0 mm
000	33490-30	2,7 mm
0000	33490-40	2,4 mm
00000	33490-50	2,0 mm

Fig. 000	33491-01
00	33491-02
0	33491-03
1	33491-04

Scharfe Löffel
 Bone Curettes
 Cucharillas cortantes
 Curette taglienti

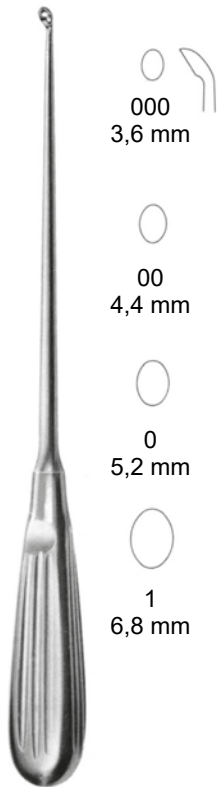

REDA
 25 cm, 10"

- Fig. 000 33491-05
- 00 33491-06
- 0 33491-07
- 1 33491-08

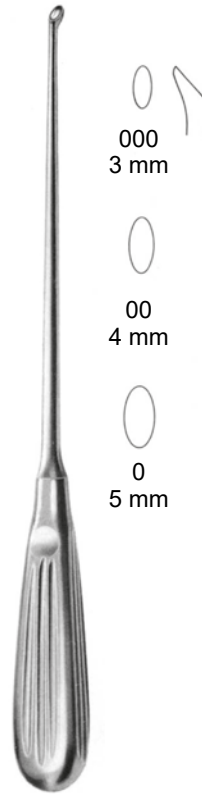

BUSHE
 25 cm, 10"

- Fig. 000 33500-01
- 00 33500-02
- 0 33500-03

Scharfe Löffel
 Bone Currettes
 Cucharillas cortantes
 Curette taglienti



33492-13	6.8 mm
33492-16	9.0 mm
33492-20	11.1 mm

33492-13	6.3 mm
33492-16	7.0 mm
33492-20	9.1 mm



VOLKMANN

33492-13	13 cm, 5 ¹ / ₈ "
33492-16	16 cm, 6 ¹ / ₄ "
33492-20	20 cm, 8"

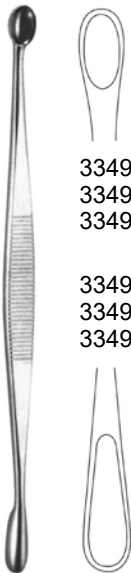

33494-13	6.4 mm
33494-14	6.6 mm
33494-17	6.8 mm

33494-13	6.3 mm
33494-14	6.9 mm
33494-17	7.3 mm



VOLKMANN

33494-13	13 cm, 5 ¹ / ₈ "
33494-14	14 cm, 5 ¹ / ₂ "
33494-17	17 cm, 6 ³ / ₄ "



5.2 mm

3.5 mm

JANSEN

33495-16	16 cm, 6 ¹ / ₄ "
----------	--

Mikro-Löffel
Micro Scoops
Micro-cucharillas
Micro curette



93430-01 230 mm / 9"
scharf
sharp
cortante
tagliente



93430-02 230 mm / 9"
scharf
sharp
cortante
tagliente

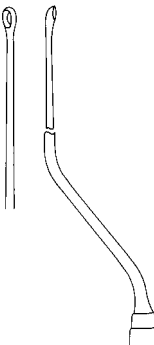

93430-03 185 mm / 7¼" YASARGIL
scharf
sharp
cortante
tagliente

Knochenspanhalter und Einsetzinstrument
Bone graft holder and impactor
Injerto óseo titular y impactador
Sostegno osseo e impattatore



CASPAR
33508-22
220 mm, 8 $\frac{3}{4}$ "

Stößel
Hemostats
Hemostáticos
Pistoni



CASPAR
200 mm, 8"

- 33509-03
Ø 3 mm
- 33509-05
Ø 5 mm
- 33509-08
Ø 8 mm



200 mm, 8"

- 33510-12
Ø 12 mm
- 33510-14
Ø 14 mm
- 33510-16
Ø 16 mm

Flachmeißel, Osteotome, Hohlmeißel
 Chisels, Osteotomes, Gouges
 Cinceles, Osteotomos, Gubias
 Scalpelli, Osteotomi, sgorbie



STILLE
20 cm, 8"



STILLE
20 cm, 8"

6 mm	33630-06	
8 mm	33630-08	
10 mm	33630-10	33631-10
12 mm	33630-12	33631-12
15 mm	33630-15	33631-15
20 mm	33630-20	33631-20
25 mm	33630-25	33631-25
30 mm	33630-30	33631-30



STILLE
20 cm, 8"



STILLE
20 cm, 8"



STILLE
20 cm, 8"

6 mm	33632-06	33633-06	33634-06
8 mm	33632-08	33633-08	33634-08
10 mm	33632-10	33633-10	33634-10
12 mm	33632-12	33633-12	33634-12
15 mm	33632-15	33633-15	33634-15
20 mm	33632-20	33633-20	33634-20
25 mm	33632-25	33633-25	33634-25
30 mm	33632-30	33633-30	33634-30

Osteotome, Hohlmeißel
 Osteotomes, Gouges
 Osteotomos, Gubias
 Osteotomi, sgorbie



SMITH-PETERSEN
 20 cm, 8"

6 mm	33644-06	33645-06	33647-06	
9 mm	33644-09	33645-09	33647-09	33649-09
13 mm	33644-13	33645-13		
14 mm			33647-14	33649-14
16 mm	33644-16	33645-16	33647-16	33649-16
19 mm	33644-19	33645-19	33647-19	33649-19
25 mm	33644-25	33645-25	33647-25	33649-25
32 mm	33644-32	33645-32	33647-32	33649-32

Osteotome
 Osteotomes
 Osteotomos
 Osteotomi

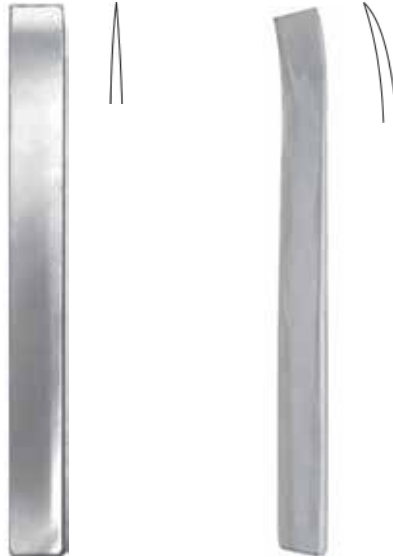

LAMBOTTE

24 cm, 9½"		24 cm, 9½"	
33650-04	4 mm	33651-04	
33650-06	6 mm	33651-06	
33650-08	8 mm	33651-08	
33650-10	10 mm	33651-10	
33650-13	13 mm	33651-13	
33650-16	16 mm	33651-16	
33650-18	18 mm	33651-18	
33650-20	20 mm	33651-20	
33650-25	25 mm	33651-25	
33650-30	30 mm	33651-30	
33650-38	38 mm	33651-38	
33650-44	44 mm	33651-44	
33650-50	50 mm	33651-50	

Osteotome
 Osteotomes
 Osteotomos
 Mini Osteotomi

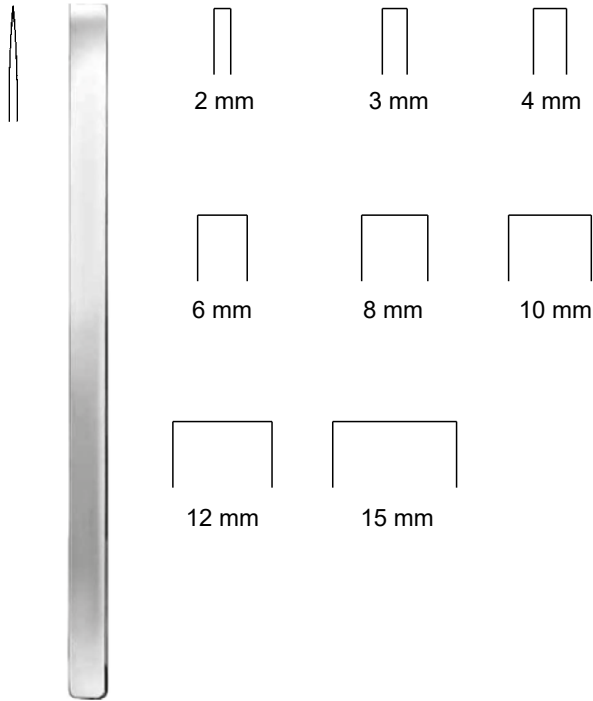

MINI-LAMBOTTE

	12,5 cm, 5"		17 cm, 6¾"
33654-02	2 mm	33652-02	
33654-03	3 mm	33652-03	
33654-04	4 mm	33652-04	
33654-06	6 mm	33652-06	
33654-08	8 mm	33652-08	
33654-10	10 mm	33652-10	
33654-12	12 mm	33652-12	
33654-15	15 mm	33652-15	

Hohlmeißel mit Ferrozellgriff
Gouges with Ferrozell-Handle
Gubias con mango de Ferrozell
Sgorbie con manico di Ferrozell

8 mm



COBB
28 cm, 11"
33656-28

8 mm



COBB
28 cm, 11"
33657-28

8 mm



COBB
28 cm, 11"
33658-28

8 mm



COBB
28 cm, 11"
33659-28

Osteotome, Hohlmeißel mit Ferrozell-Griff
 Osteotomes, Gouges with Ferrozell-Handle
 Osteotomos, Gubias con mango de Ferrozell
 Sgorbie, Osteotomo, con manico di Ferrozell

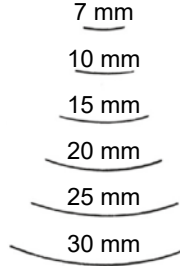
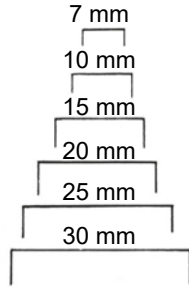

33660-07	7 mm	33661-07
33660-10	10 mm	33661-10
33660-15	15 mm	33661-15
33660-20	20 mm	33661-20
33660-25	25 mm	33661-25
33660-30	30 mm	33661-30

Auch mit Peek Griff verfügbar!
 Also available with Peek handle!
 Tambien disponible con mango Peek!
 Anche disponibile con impugnatura Peek!

LEXER
 22 cm, 8³/₄"

LEXER
 22 cm, 8³/₄"

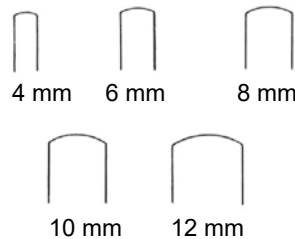
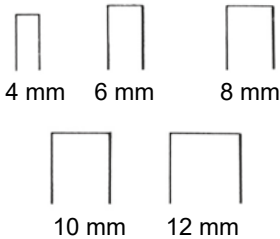

33664-04	4 mm	33665-04
33664-06	6 mm	33665-06
33664-08	8 mm	33665-08
33664-10	10 mm	33665-10
33664-12	12 mm	33665-12

LEXER MINI
 18 cm, 7"

LEXER MINI
 18 cm, 7"

Flachmeißel, Hohlmeißel
Chisels, Gouges
Cinceles, Gubias
Scalpelli, sgorbie



33665-24
24,5 cm, 9¾"

33665-26
26,5 cm, 10½"

ZIELKE
23 cm, 9"
33665-55 5,5 mm
33665-90 9,0 mm

33666-22
22 cm, 8¾"

Meißel
Gouges
Gubias
Sgorbie

Wirbelsäulenmeißel
Lamina gouge
Gubias para la columna vertebral
Sgorbie per la colonna vertebrale



CAPENER
23,5 cm, 9¼"
33667-06 6 mm
33667-08 8 mm
33667-11 11 mm
33667-16 16 mm

Hohlmeißel mit NOVOTEX-Griff
Gouges with NOVOTEX-Handle
Gubias con mango de NOVOTEX
Sgorbie con manico di NOVOTEX

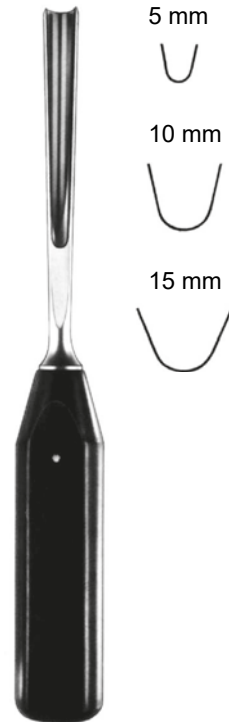

— 25 cm, 10" —
33669-05 5 mm 33670-05
33669-10 10 mm 33670-10
33669-15 15 mm 33670-15

Septum Osteotom
Rhinoplastic Osteotome
Osteotomos para la plástica nasal
Osteotomo per plastica nasale

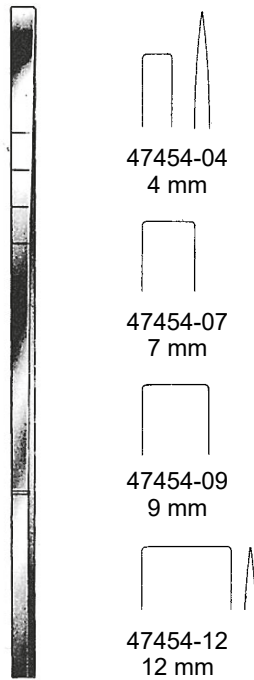

COTTLE
18 cm, 7"

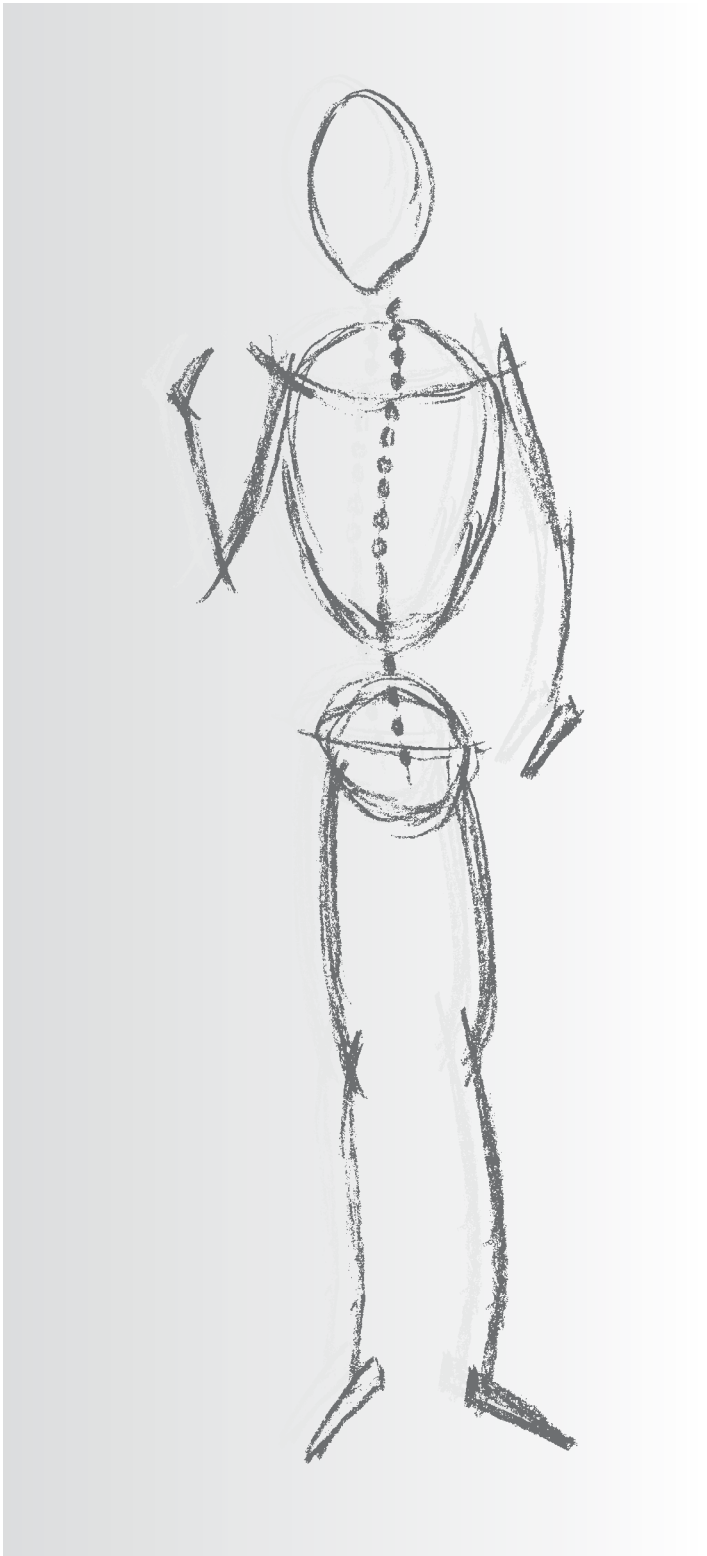

Reda Instrumente GmbH
Gänsäcker 34 - P.O. Box 131
D-78532 Tuttlingen

**ELEVATORIEN
RASPATORIEN
DISSEKTOREN**

**ELEVATORS
RASPATORIES
DISSECTORS**

**ELEVADORES
PERIOSTÓTOMOS
DISECTORES**

**ELEVATORI
PERIOSTOTOMI
DISSETTORI**

Elevatorien, Raspatorien, Dissektoren
Elevators, Raspatories, Dissectors
Elevadores, Periostótomos, Disectores
Elevatori, Periostotomi, Dissettori

15 mm

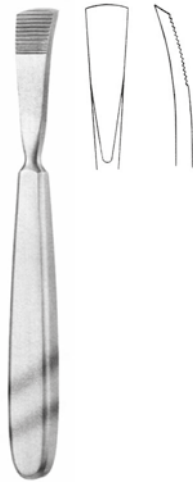

JANSEN
33701-16
16,5 cm, 6½"

12,5 mm



FARABEUF
33702-15
15 cm, 5.9"

12,5 mm



FARABEUF
33703-15
15 cm, 5.9"

11 mm



FARABEUF-COLLIN
33704-01
15,5 cm, 6"

Elevatoren, Raspatorien, Dissektoren
 Elevators, Raspatories, Dissectors
 Elevadores, Periostótomos, Disectores
 Elevatori, Periostotomi, Dissettori

11 mm

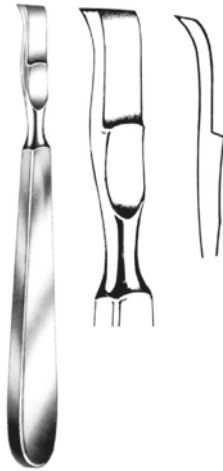

FARABEUF-COLLIN
 33704-02
 15,5 cm, 6"



LAMBOTTE
 21 cm, 8¼"
 33705-05 5 mm
 33705-10 10 mm
 33705-15 15 mm
 33705-20 20 mm
 33705-25 25 mm

18 mm



SEDILLOT
 33706-18
 18 cm, 7"

6 mm



**CUSHING
 (LITTLE-JOKER)**
 33707-15
 15 cm, 5.9"

Elevatoriën, Raspatoriën, Dissektoren
 Elevators, Raspatories, Dissectors
 Elevadores, Periostótomos, Disectores
 Elevatori, Periostotomi, Dissettori

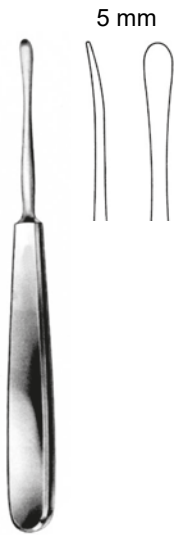

SEBILLEAU
 33707-17
 17,5 cm, 7"

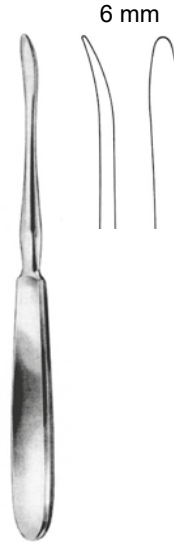

QUERVAIN
 33708-19
 19,5 cm, 7¾"

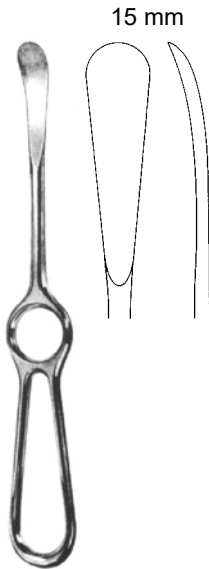

SEDILLOT
 33709-21
 21 cm, 8¼"

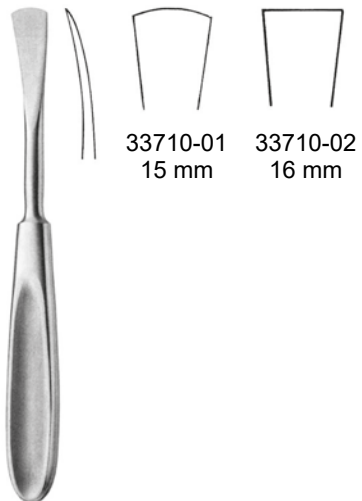

CUSHING
 18 cm, 7"

Elevatoren, Raspatorien, Dissektoren
 Elevators, Raspatories, Dissectors
 Elevadores, Periostótomos, Disectores
 Elevatori, Periostotomi, Dissettori

halbscharf
 semi-sharp
 semi agudo
 semiacuto



HOEN
 18 cm, 7"



7 mm

33710-07



15 mm

33710-15



20 mm

33710-20

16 mm



LANGENBECK
 33710-19
 19 cm, 7½"

14 mm



LANGENBECK
 33711-18
 18 cm, 7"



LANGENBECK
 20 cm, 8"
 33711-20 8 mm
 33711-21 10 mm

Elevatorien, Raspatorien, Dissektoren
 Elevators, Raspatories, Dissectors
 Elevadores, Periostótomos, Disectores
 Elevatori, Periostotomi, Dissettori

4 mm



WILLIGER
 33711-16
 16 cm, 6¼"

6,5 mm



WILLIGER
 33712-16
 16 cm, 6¼"

5 mm



WILLIGER
 33713-16
 16 cm, 6¼"

5,5 mm



WILLIGER
 33713-17
 17 cm, 6¾"

5 mm

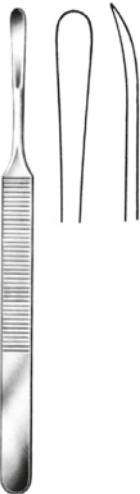

KÖNIG
 33714-15
 15,5 cm, 6"

12 mm

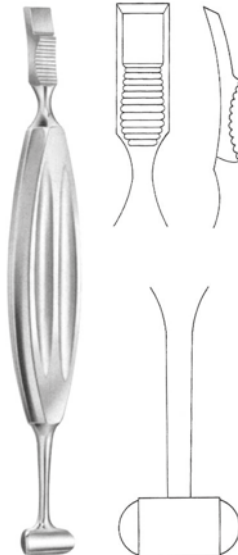

ALEXANDER
 33715-20
 21 cm, 8¼"

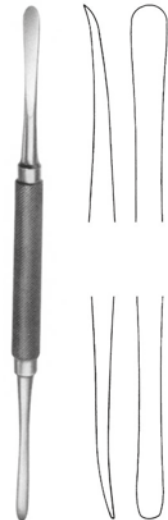

MOLT
 33716-18
 18 cm, 7"

Elevatori, Raspatori, Dissektoren
Elevators, Raspatories, Dissectors
Elevadores, Periostótomos, Disectores
Elevatori, Periostotomi, Dissettori

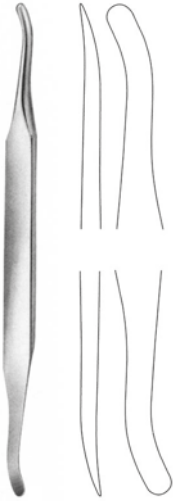

SELDIN
33717-19-01
19,5 cm, 7¾"

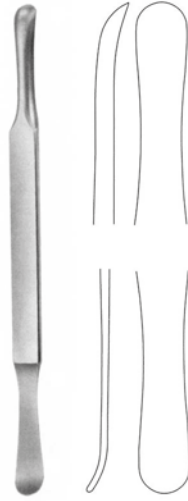

SELDIN
33717-19-02
19,5 cm, 7¾"

4 mm



JOSEPH
33718-16
16 cm, 6¼"

4 mm



FOMON
33719-17
17 cm, 6¾"

9 mm

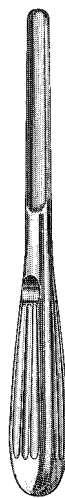

BOIES
33720-19
19 cm, 7½"



GORNEY
33720-21
21 cm, 8¼"

Elevatoren, Raspatorien, Dissektoren
Elevators, Raspatories, Dissectors
Elevadores, Periostótomos, Disectores
Elevatori, Periostotomi, Dissettori

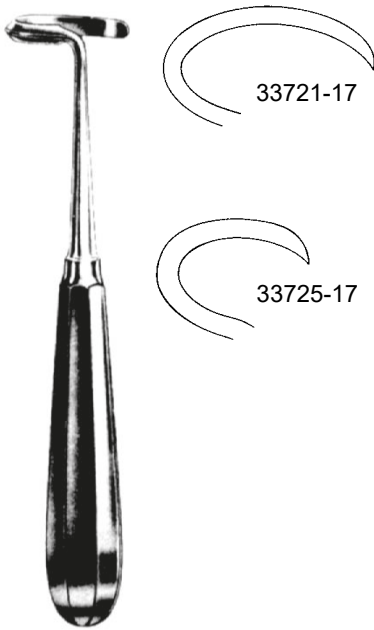

DOYEN
17 cm, 6¾"

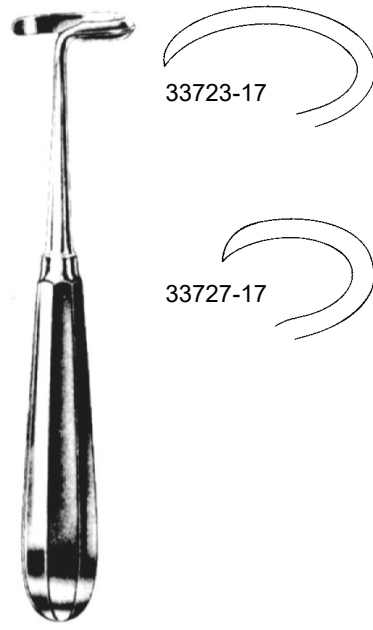
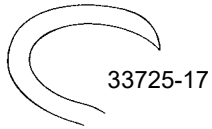

DOYEN
17 cm, 6¾"

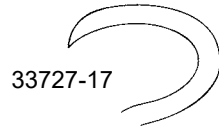

Elevatoren, Raspatorien, Dissektoren
Elevators, Raspatories, Dissectors
Elevadores, Periostótomos, Disectores
Elevatori, Periostotomi, Dissettori



17 cm, 6¾"

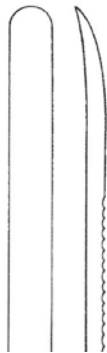

33722-06
6 mm

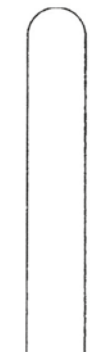

33722-08
8 mm

Hohlheft
hollow handle
mango hueco
manico vuoto



33728-24



33729-24



DOYEN
24 cm, 9½"

Elevatorien, Raspatorien, Dissektoren
Elevators, Raspatories, Dissectors
Elevadores, Periostótomos, Disectores
Elevatori, Periostotomi, Dissettori

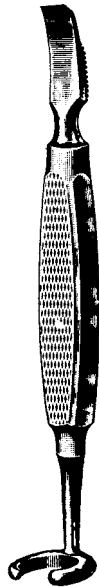

MATSON-ALEXANDER
33731-22
22 cm, 8 $\frac{3}{4}$ "

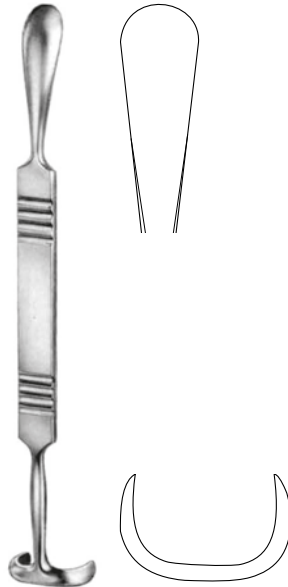

MATSON
33733-22
22 cm, 8 $\frac{3}{4}$ "

Elevatorien, Raspatorien, Dissektoren
 Elevators, Raspatories, Dissectors
 Elevadores, Periostótomos, Disectores
 Elevatori, Periostotomi, Dissettori



33740-19
 19 cm, 7½"



33741-18
 18,5 cm, 7¼"



33742-18
 18,5 cm, 7¼"



33743-18
 18,5 cm, 7¼"

Auch mit Peek Griff verfügbar!
 Also available with Peek handle!
 Tambien disponible con mango Peek!
 Anche disponibile con impugnatura Peek!

Elevatoren, Raspatorien, Dissektoren
 Elevators, Raspatories, Dissectors
 Elevadores, Periostótomos, Disectores
 Elevatori, Periostotomi, Dissettori



33745-19
 18,5 cm, 7¼"



33746-19
 19,5 cm, 7¾"



33747-18
 18,5 cm, 7¼"

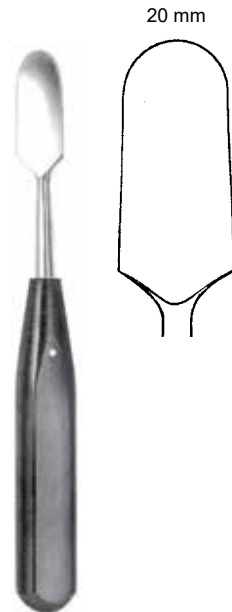

33748-20
 20 cm, 8"

Auch mit Peek Griff verfügbar!
 Also available with Peek handle!
 También disponible con mango Peek!
 Anche disponibile con impugnatura Peek!

Elevatoren, Raspatorien, Dissektoren
 Elevators, Raspatories, Dissectors
 Elevadores, Periostótomos, Disectores
 Elevatori, Periostotomi, Dissettori

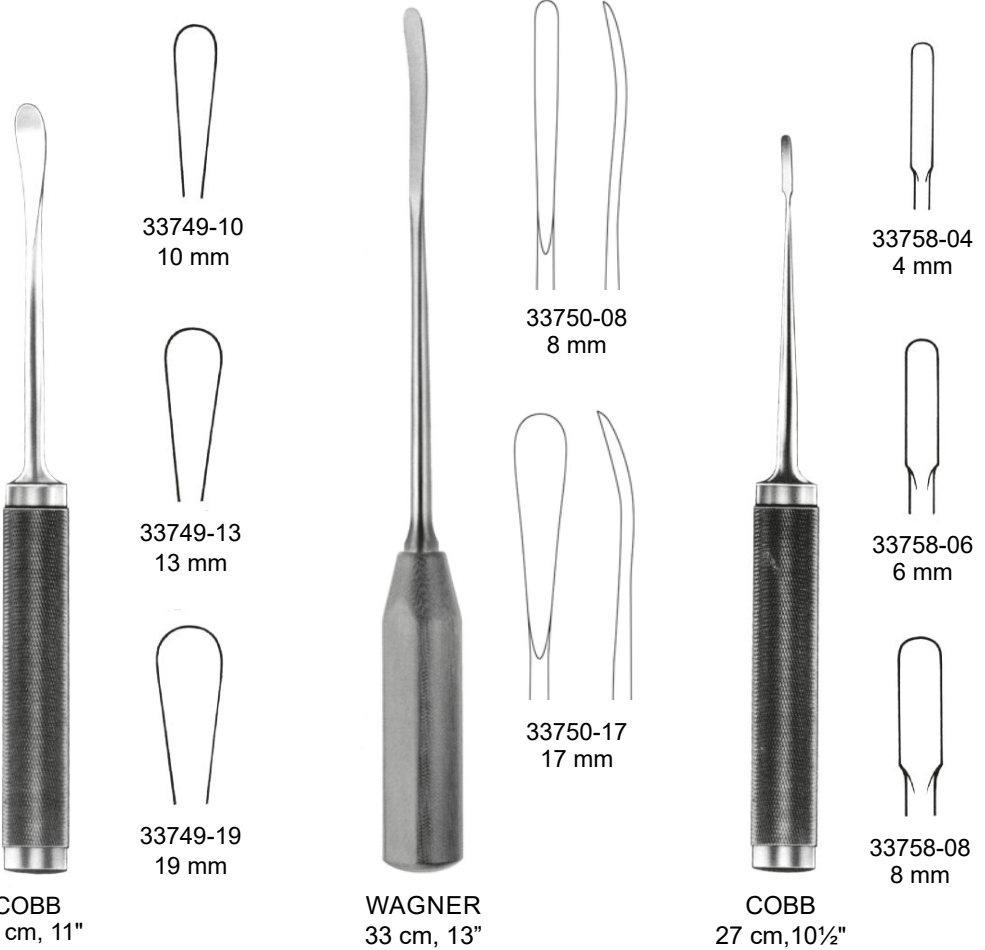

mit NOVOTEX-Kunststoffgriff
 with NOVOTEX plastic handle
 con mango de materia plástica NOVOTEX
 con manico di materia plastica NOVOTEX

Elevatorien, Raspatorien, Dissektoren
 Elevators, Raspatories, Dissectors
 Elevadores, Periostótomos, Disectores
 Elevatori, Periostotomi, Dissettori



ADSON
 17 cm, 6¾"



33754-17



33755-17



33756-17



33757-17



KEY
 33759-06 - 33759-25
 19 cm, 7½"

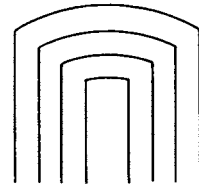

33759-06	6 mm
33759-12	12 mm
33759-19	19 mm
33759-25	25 mm

Elevatoren, Raspatorien, Dissektoren
 Elevators, Raspatories, Dissectors
 Elevadores, Periostótomos, Disectores
 Elevatori, Periostotomi, Dissettori

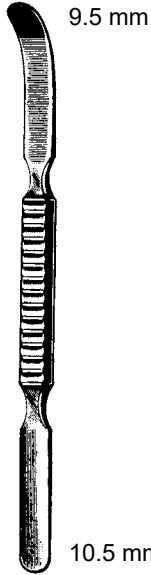

WATSON-CHEYNE
 33765-17
 17,5 cm, 7"

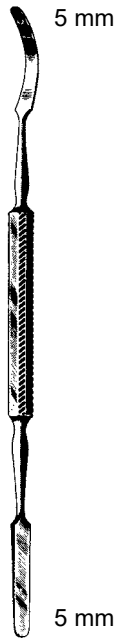

MC DONALD
 33767-19
 19 cm, 7½"



JOSEPH
 47411-16
 16 cm, 6¼"



SEWALL
 47412-20
 20 cm, 8"

Elevatoren, Raspatorien, Dissektoren
Elevators, Raspatories, Dissectors
Elevadores, Periostótomos, Disectores
Elevatori, Periostotomi, Dissettori

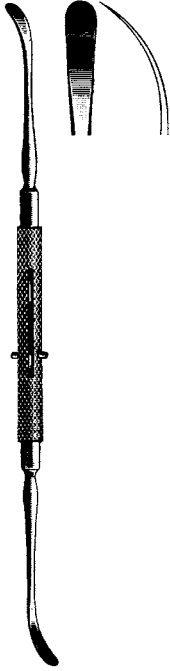

ROGER
47413-19
19 cm, 7½"

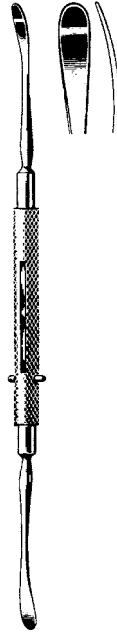

FREER
47415-18
18 cm, 7"

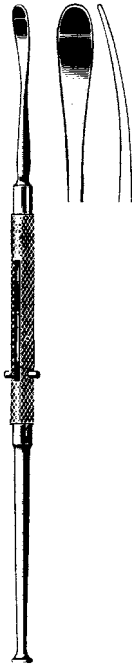

FREER
47417-19
19 cm, 7½"

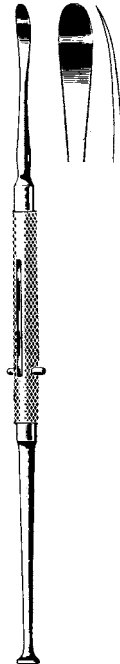

FREER
47419-19
19 cm, 7½"

Dura Dissektoren
Dura Dissectors
Disectores para duramadre
Dissettori per dura-madre



SACHS
41143-21
21 cm, 8¼"



TOENNIS
41141-25
25 cm, 10"

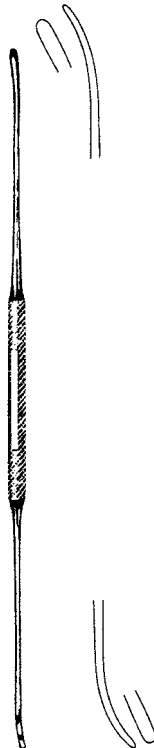

OLIVECRONA
41146-18 18 cm, 7"
41146-24 24 cm, 9½"



DAVIS
41142-19
19 cm, 7½"

Dura Dissektoren
Dura Dissectors
Disectores para duramadre
Dissettori per dura-madre

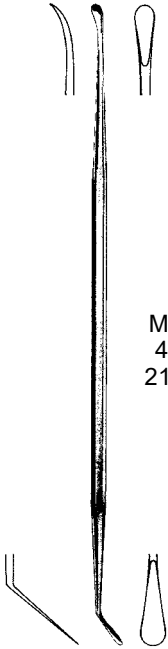

MILLIGAN
41147-21
21 cm, 8 $\frac{1}{4}$ "

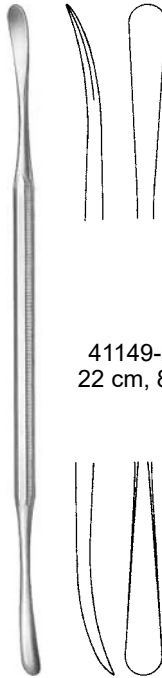

41149-22
22 cm, 8 $\frac{3}{4}$ "

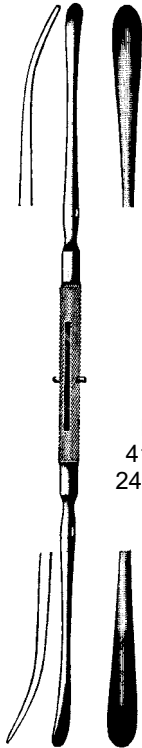

DAVIS
41151-24
24 cm, 9 $\frac{1}{2}$ "

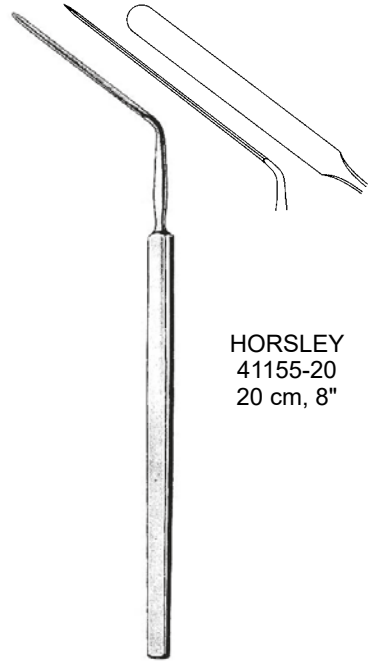

HORSLEY
41155-20
20 cm, 8"

Dura Dissektoren
Dura Dissectors
Disectores para duramadre
Dissettori per dura-madre



WOODSON
41156-18
18 cm, 7"

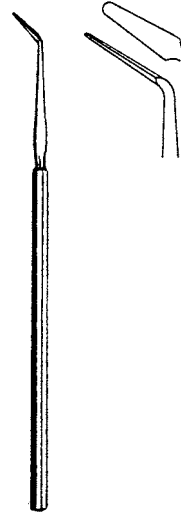

FRAZIER
41158-01
15 cm, 6"

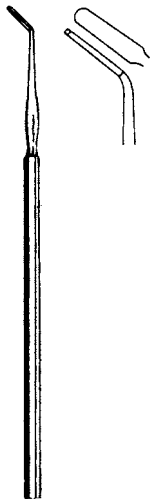

HOEN
41158-02
15 cm, 6"

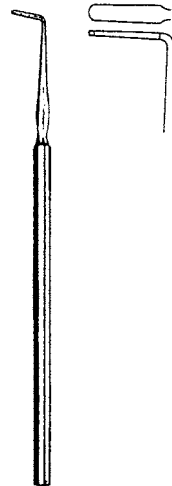

HOEN
41158-03
15 cm, 6"

Dissektoren, doppelendig
 Dissectors, double ended
 Disectores, de doble extremo
 Dissettori, doppio

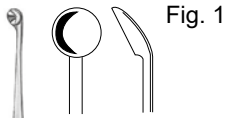

PENFIELD
 41161-01
 175 mm, 7"



 **Fig. 2**



PENFIELD
 41161-02
 195 mm, 7¾"



 **Fig. 3**



PENFIELD
 41161-03
 195 mm, 7¾"



Fig. 4



PENFIELD
 41161-04
 205 mm, 8"



Fig. 5

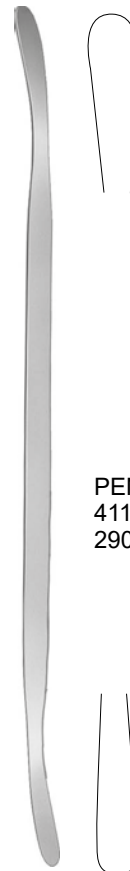

PENFIELD
 41161-05
 290 mm, 11½"



Mikro-Raspatorien
 Micro-Raspatories
 Legras para micro-cirugía
 Micro periostotomi

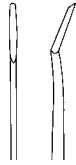

93410-01 185 mm / 7¼" YASARGIL

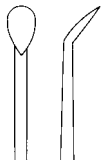

93410-02 185 mm / 7¼" YASARGIL



93410-03 185 mm / 7¼" YASARGIL



93410-05 185 mm / 7¼" YASARGIL

2,0 mm

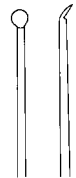

93410-06 230 mm / 9"
 plattenförmig
 round blade
 redondo
 rotondo piatto

3,0 mm



93410-07 230 mm / 9"
 plattenförmig
 round blade
 redondo
 rotondo piatto

Mikro-Raspatorien
Micro-Raspatories
Legras para micro-cirugía
Micro periostotomi

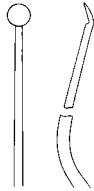

93420-01 230 mm / 9"

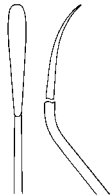

93420-02 185 mm / 7¼" YASARGIL

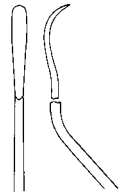

93420-03 185 mm / 7¼" YASARGIL

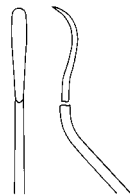

93420-04 185 mm / 7¼" YASARGIL

Mikro-Dissektoren
Micro Dissectors
Micro dissectores
Micro scollatori



4,5 mm



CASPAR
93480-23
230 mm / 9"

1,0 mm



CASPAR
93481-20
200 mm / 8"

1,4 mm



93482-23
230 mm / 9"

2,0 mm



93483-23
230 mm / 9"

1,8 mm



93484-23
230 mm / 9"

3,0 mm



93485-18
185 mm / 7 1/4"

3,0 mm

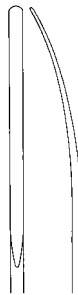

93486-21
215 mm / 8 1/4"



YASARGIL
93487-18
185 mm / 7 1/4"

Mikro-Dissektoren
 Micro Dissectors
 Micro dissectores
 Micro scollatori

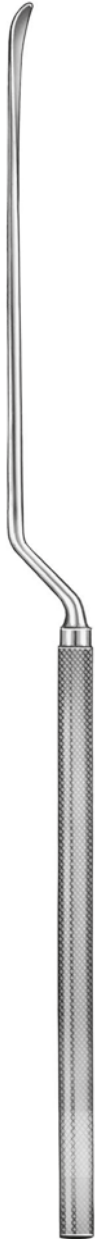

93490-01 230 mm / 9" CASPAR



93490-02 230 mm / 9" CASPAR



93490-03 210 mm / 8¼" CASPAR



93490-04 210 mm / 8¼" CASPAR



93490-05 230 mm / 9"



93490-06 230 mm / 9"

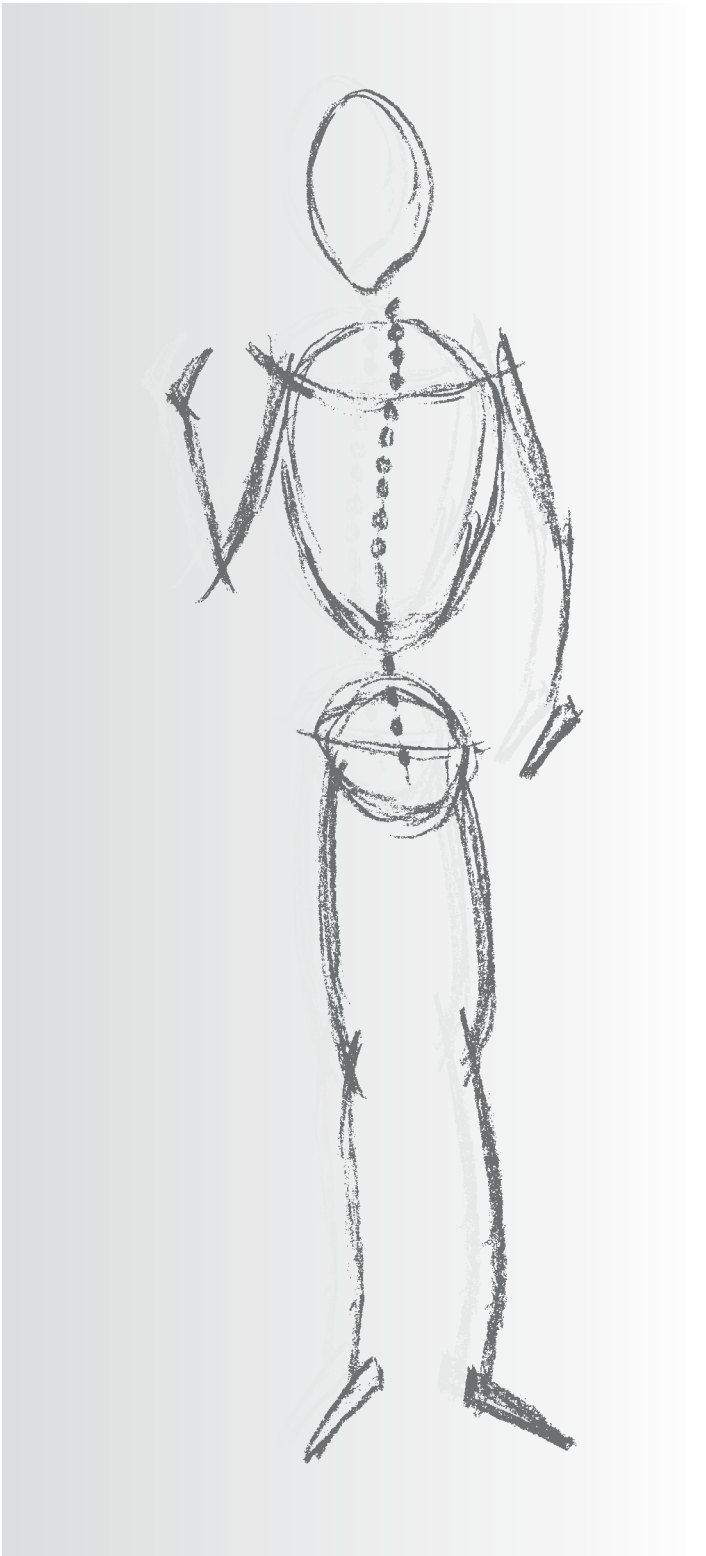

Reda Instrumente GmbH
Gänsäcker 34 - P.O. Box 131
D-78532 Tuttlingen

SAUGROHRE

SUCTION TUBES

TUBOS DE ASPIRACIÓN

TUBI D'ASPIRAZIONE

Saugrohre
Suction Tubes
Tubos de aspiración
Tubi aspirazioni



ADSON
41290-21
21 cm, 8¼"
ø 4 mm

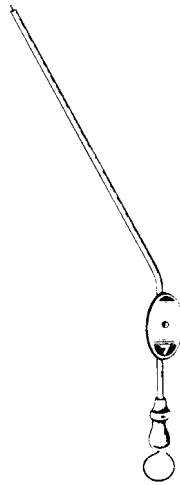

BARON
16 cm, 6¼"
41299-03 3FR 1,0 mm
41299-05 5FR 1,6 mm
41299-07 7FR 2,3 mm



FERGUSON
41294-40
18 cm, 7"
ø 4 mm, 90°

isoliert
insolated
aislado
isolato

Punktionskanüle, Saugrohre
 Puncture Cannulas, Suction Tubes
 Tubo de punción, Tubos de aspiración
 Cannula per punzione, Tubi aspirazioni,



Arbeitslänge Working Length Longitud de trabajo Lunghezza di lavoro	13 cm, /5 $\frac{1}{8}$ "	16 cm, /6 $\frac{1}{4}$ "	20 cm, /7 $\frac{1}{8}$ "
Gesamtlänge Total Length Longitud total Lunghezza totale	19,5 cm, /7 $\frac{3}{4}$ "	24,5 cm, /8 $\frac{1}{2}$ "	28 cm, /11"
Charr. F.G.	8	10	12
	41295-08-13	41295-10-13	41295-12-13
	41295-08-16	41295-10-16	41295-12-16
	41295-08-20	41295-10-20	41295-12-20

FERGUSSON

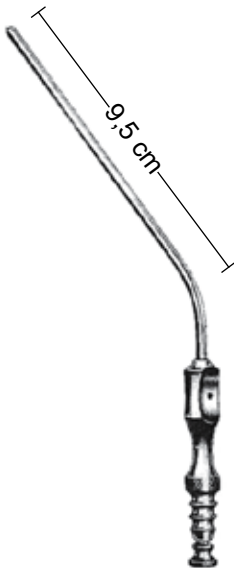

Charr.	30°	75°
F.G.	4	5
	41295-04	41295-05
	6	7
	41295-06	41295-07
	8	9
	41295-08	41295-09
	10	11
	41295-10	41295-11
	12	15
	41295-12	41295-15

FRAZIER/FERGUSSON
 41295-04 – 41297-15
 19 cm, 7 $\frac{1}{2}$ "

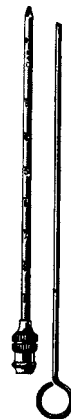

FRAZIER/FERGUSSON
 41298-12
 12 cm, 4 $\frac{3}{4}$ " / 3 mm

Saugrohre
Suction Tubes
Tubos de aspiración
Tubi aspirazioni

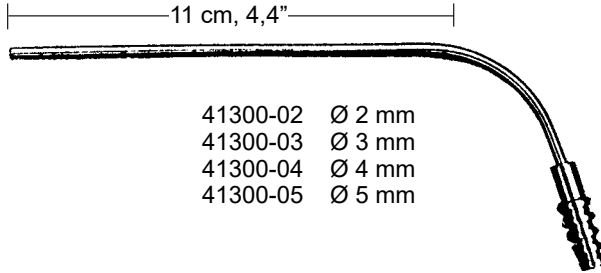

- 41300-02 Ø 2 mm
- 41300-03 Ø 3 mm
- 41300-04 Ø 4 mm
- 41300-05 Ø 5 mm

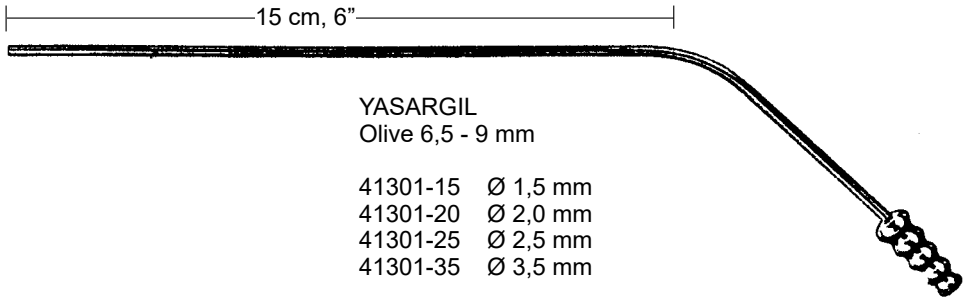

YASARGIL
Olive 6,5 - 9 mm

- 41301-15 Ø 1,5 mm
- 41301-20 Ø 2,0 mm
- 41301-25 Ø 2,5 mm
- 41301-35 Ø 3,5 mm

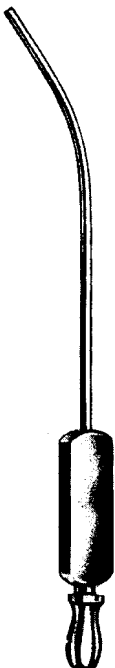

ZÖLLNER
41302-01



ZÖLLNER
41302-02



- 0,5 mm Ø 41306-05
- 0,7 mm Ø 41306-07
- 0,9 mm Ø 41306-09
- 1,2 mm Ø 41306-12

Kanüle für Sauggriff
für Zöllner und Wullstein

Tip for Suction Handle
for Zöllner and Wullstein

Cánula para mango
para Zöllner y Wullstein

Cannula per manico di aspirazione
per Zöllner e Wullstein

Saugrohre
Suction Tubes
Tubos de aspiración
Tubi aspirazioni

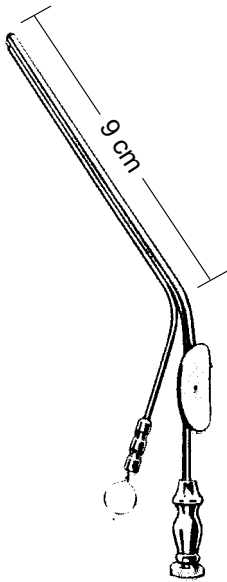

HOUSE
9 cm, 3½"

- 41303-09 Ø 0,9 x 0,7 mm
- 41303-12 Ø 1,2 x 0,9 mm
- 41303-15 Ø 1,5 x 1,2 mm
- 41303-18 Ø 1,8 x 1,8 mm
- 41303-25 Ø 2,5 x 2,0 mm
- 41303-30 Ø 3,0 x 2,0 mm
- 41303-45 Ø 4,5 x 2,0 mm



PLESTER 30°

- Charr. 6 41304-06
- Charr. 8 41304-08
- Charr. 10 41304-10

Saugrohre
Suction Tubes
Tubos de aspiración
Tubi aspirazioni

Mikro-Saugkanüle
Micro suction cannula
Micro tubo de aspiración
Micro-cannula d'aspirazione

Saugraspatorium
Suction Raspatory
Legra de succión
Raspatorio con aspiratore

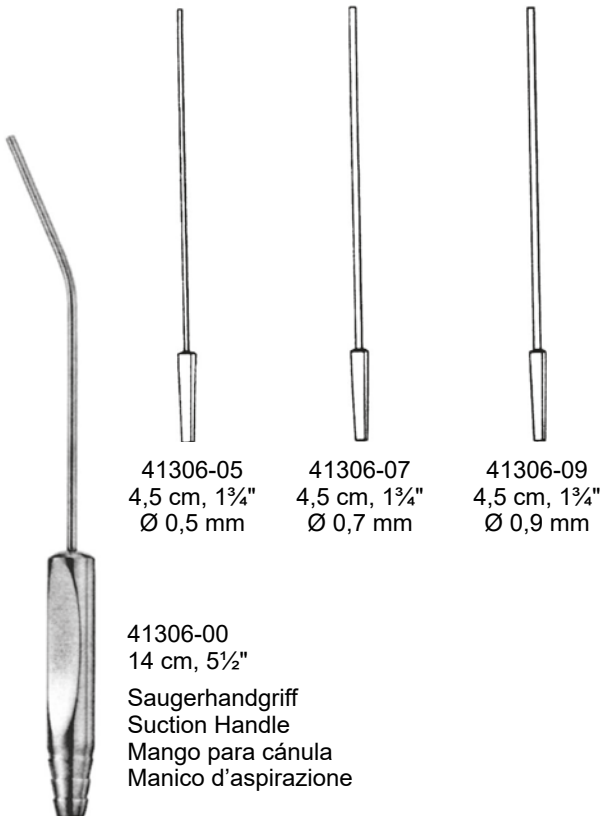

WULLSTEIN
41308-00

komplett, mit Griff und drei Aufsätzen
complete, with handle and 3 tips
completo, con mango y 3 puntas
completo, con manico e 3 punte



GUILLEN
47347-20
19 cm, 7 $\frac{1}{2}$ "

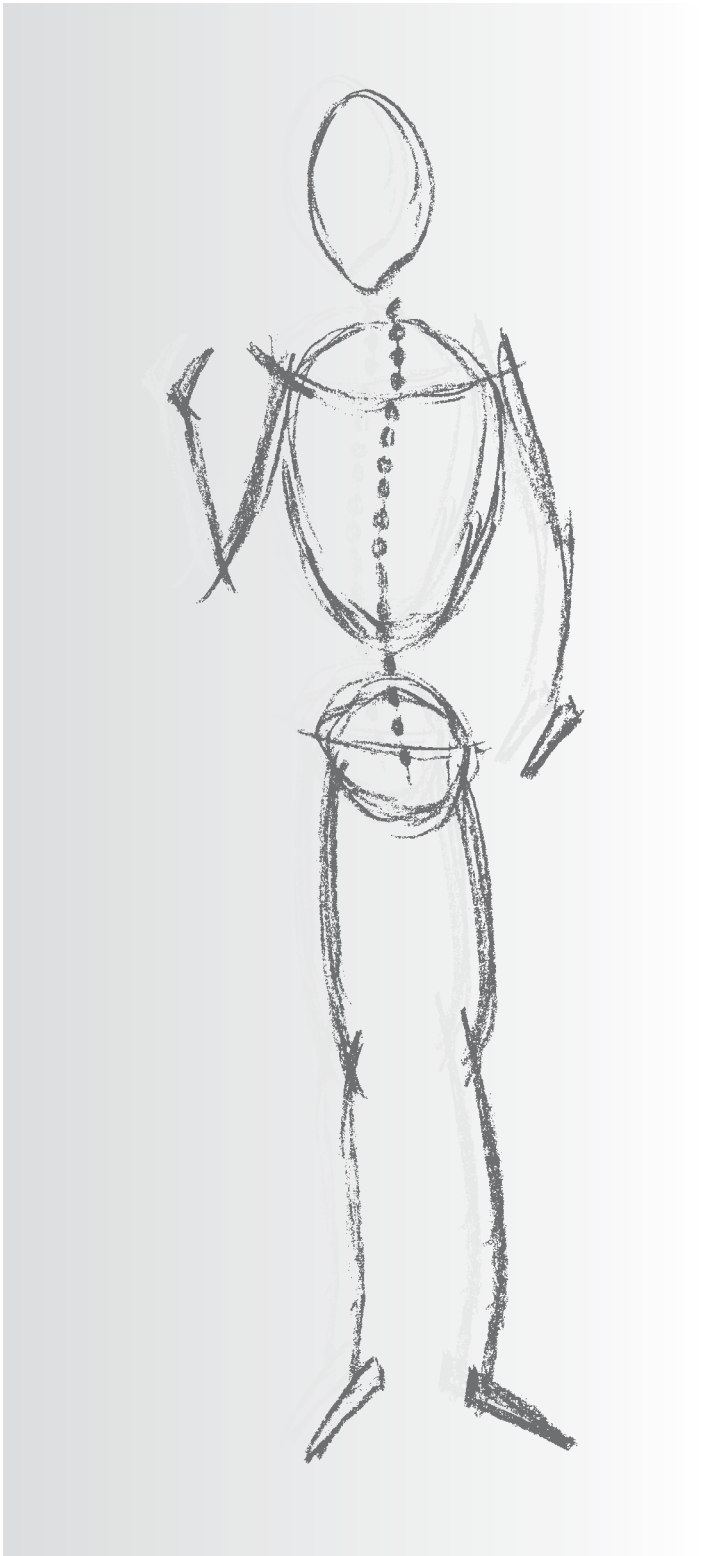

Reda Instrumente GmbH
Gänsäcker 34 - P.O. Box 131
D-78532 Tuttlingen

LAMINEKTOMIE

LAMINECTOMY

LAMINECTOMIA

LAMINECTOMIA

Laminektomie Zangen
 Laminectomy Forceps
 Pinzas para laminectomia
 Pinze per laminectomia

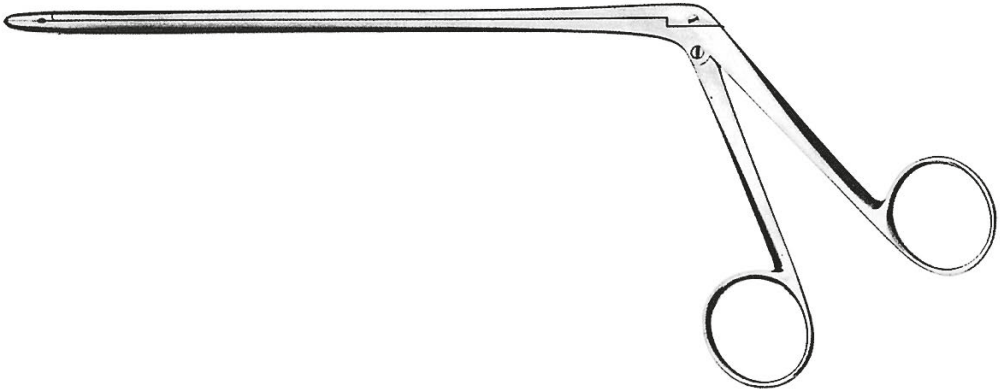

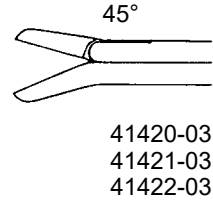
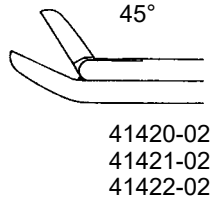
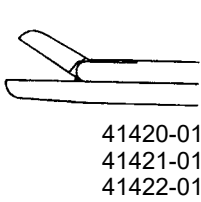

 CUSHING
 2 x 10 mm

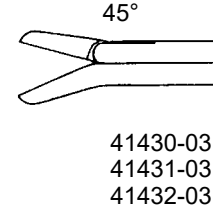
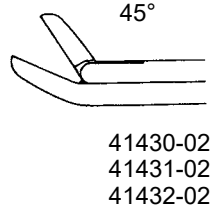
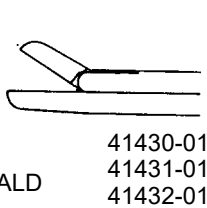

125 mm / 5"
 150 mm / 6"
 180 mm / 7"

 LOVE-GRUENWALD
 3 x 10 mm



125 mm / 5"
 150 mm / 6"
 180 mm / 7"

 SPURLING
 4 x 10 mm

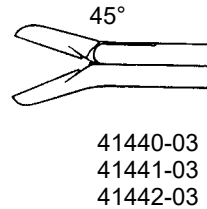
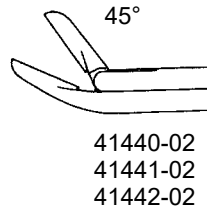
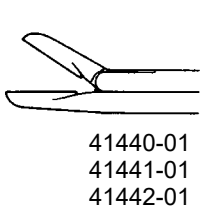

125 mm / 5"
 150 mm / 6"
 180 mm / 7"

Laminektomie Zangen
Laminectomy Forceps
Pinzas para laminectomia
Pinze per laminectomia

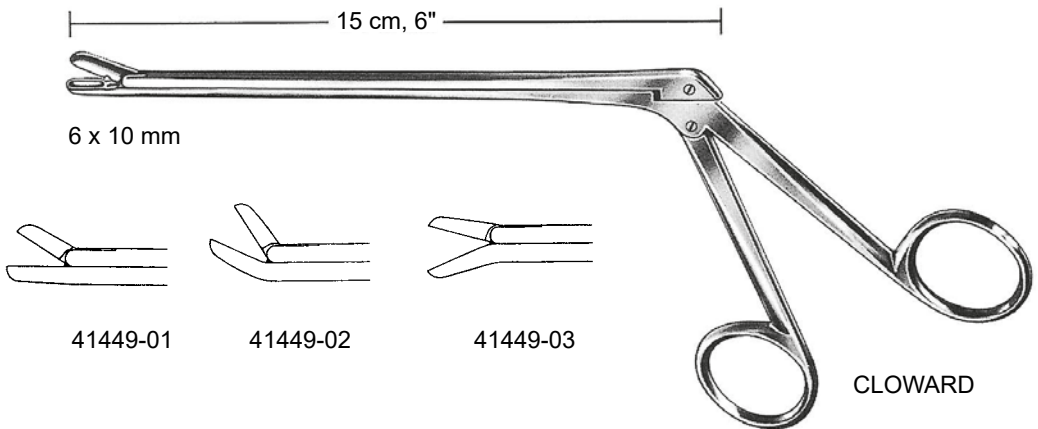
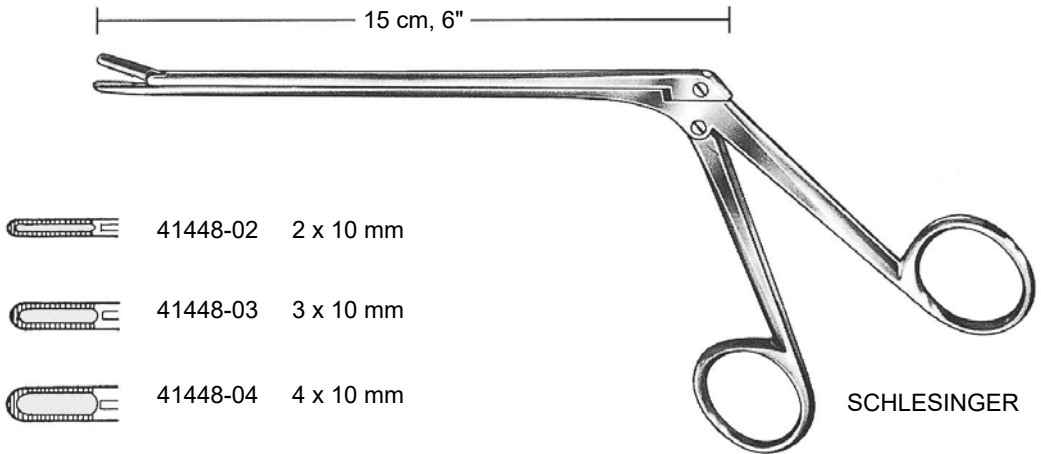

Laminektomie Zangen
Laminectomy Forceps
Pinzas para laminectomia
Pinze per laminectomia

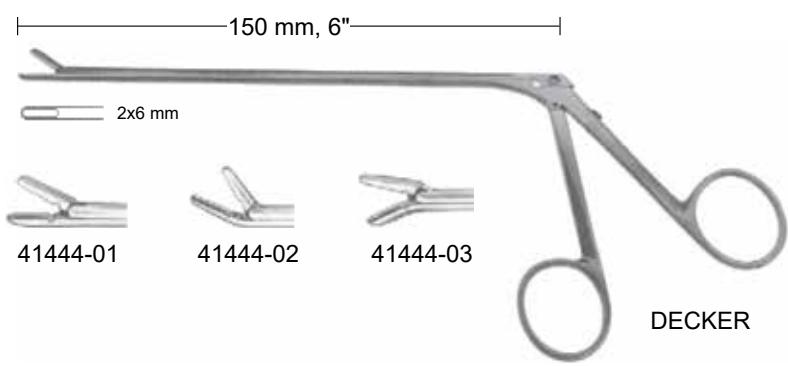
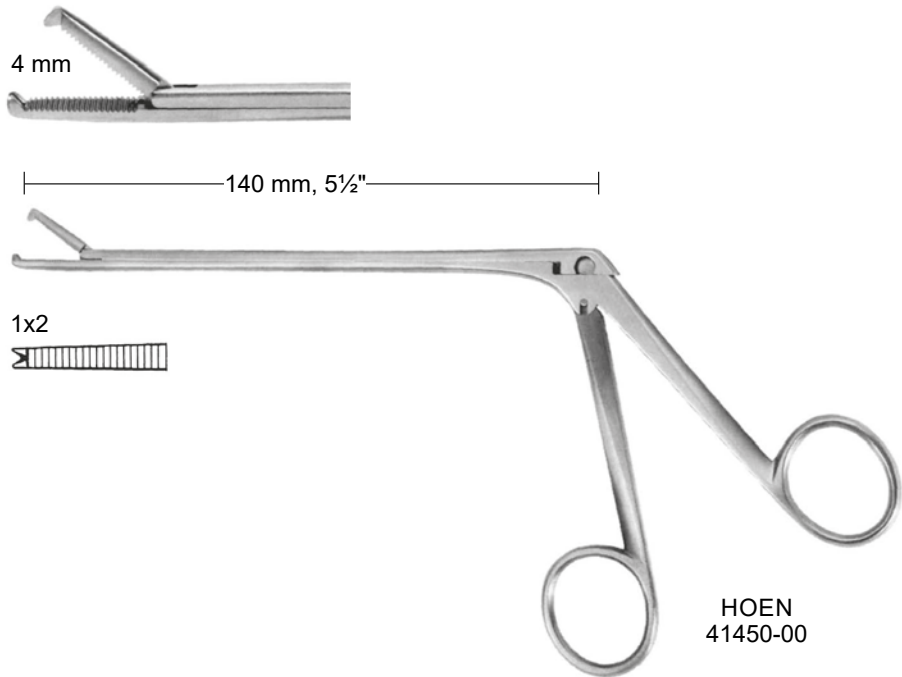

Laminektomie Zangen
Laminectomy Forceps
Pinzas para laminectomia
Pinze per laminectomia

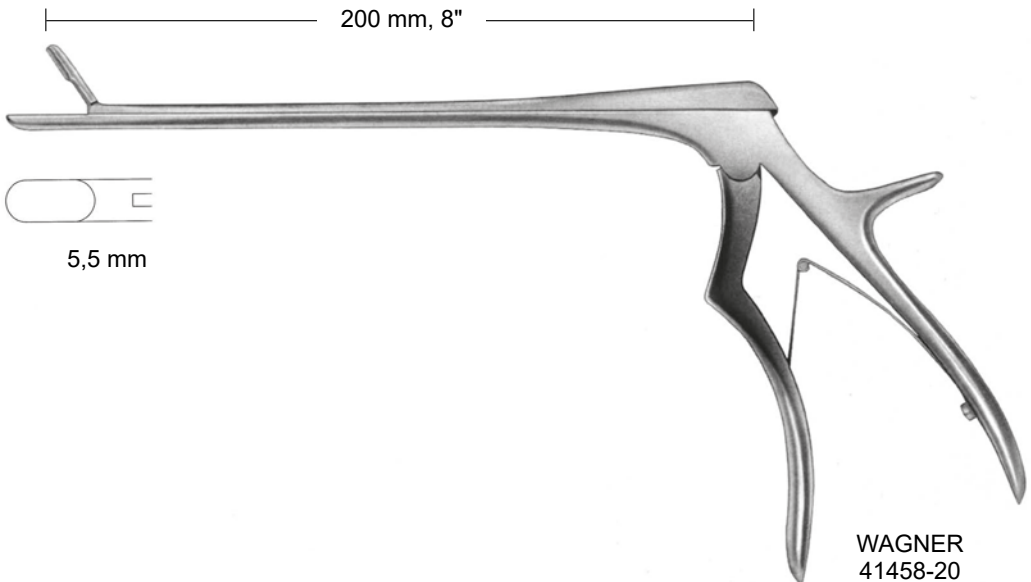
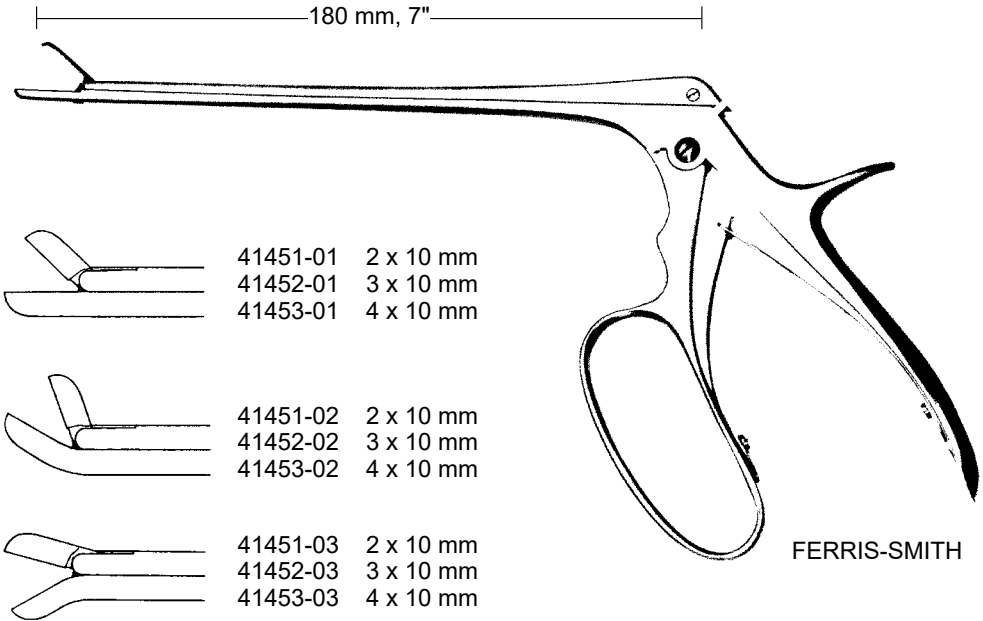

Laminektomie Zangen
 Laminectomy Forceps
 Pinzas para laminectomia
 Pinze per laminectomia

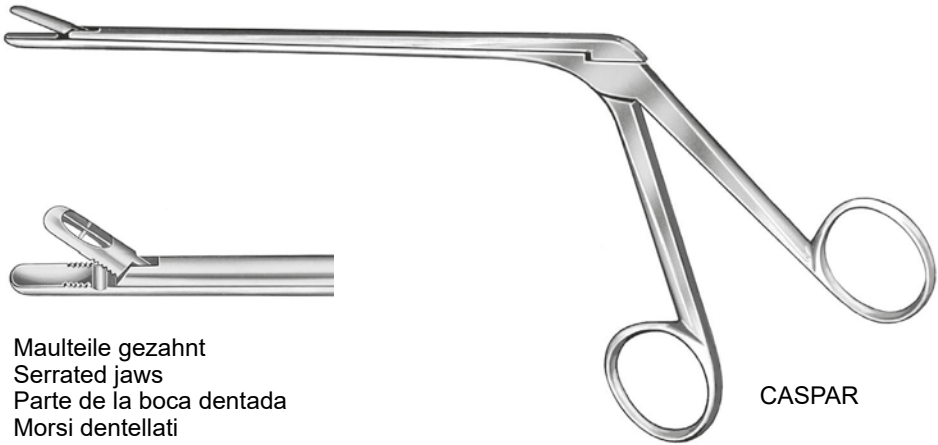

Maulteile gezahnt
 Serrated jaws
 Parte de la boca dentada
 Morsi dentellati

CASPAR

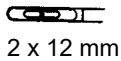
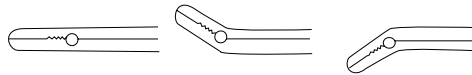

2 x 12 mm

41460-01
 41461-01
 41462-01

41460-02
 41461-02
 41462-02

41460-03
 41461-03
 41462-03

140 mm / 5½"
 160 mm / 6¼"
 185 mm / 7¼"

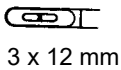

3 x 12 mm

41465-01
 41466-01
 41467-01

41465-02
 41466-02
 41467-02

41465-03
 41466-03
 41467-03

140 mm / 5½"
 160 mm / 6¼"
 185 mm / 7¼"

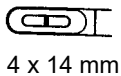

4 x 14 mm

41470-01
 41471-01
 41472-01

41470-02
 41471-02
 41472-02

41470-03
 41471-03
 41472-03

140 mm / 5½"
 160 mm / 6¼"
 185 mm / 7¼"

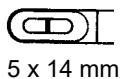

5 x 14 mm

41475-01
 41476-01
 41477-01

41475-02
 41476-02
 41477-02

41475-03
 41476-03
 41477-03

140 mm / 5½"
 160 mm / 6¼"
 185 mm / 7¼"

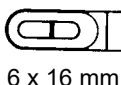

6 x 16 mm

41480-01
 41481-01
 41482-01

41480-02
 41481-02
 41482-02

41480-03
 41481-03
 41482-03

140 mm / 5½"
 160 mm / 6¼"
 185 mm / 7¼"

Laminektomie Zangen
Laminectomy Forceps
Pinzas para laminectomia
Pinze per laminectomia

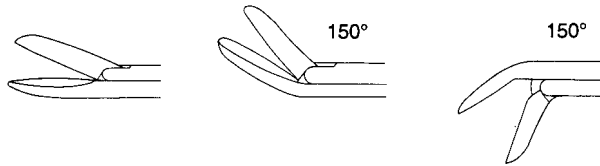
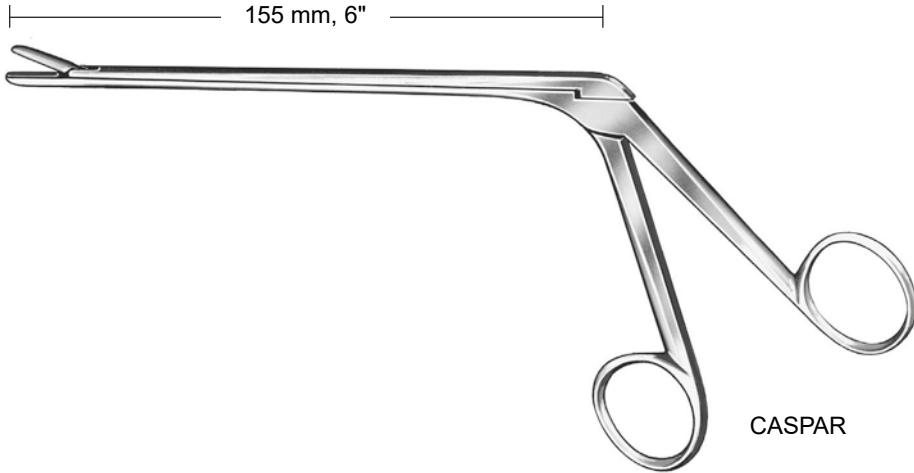

2 mm

41490-01

41490-02

41490-03

3 mm

41492-01

41492-02

41492-03

4 mm

41494-01

41494-02

41494-03

5 mm

41496-01

41496-02

41496-03

Laminektomie Zangen
 Laminectomy Forceps
 Pinzas para laminectomia
 Pinze per laminectomia

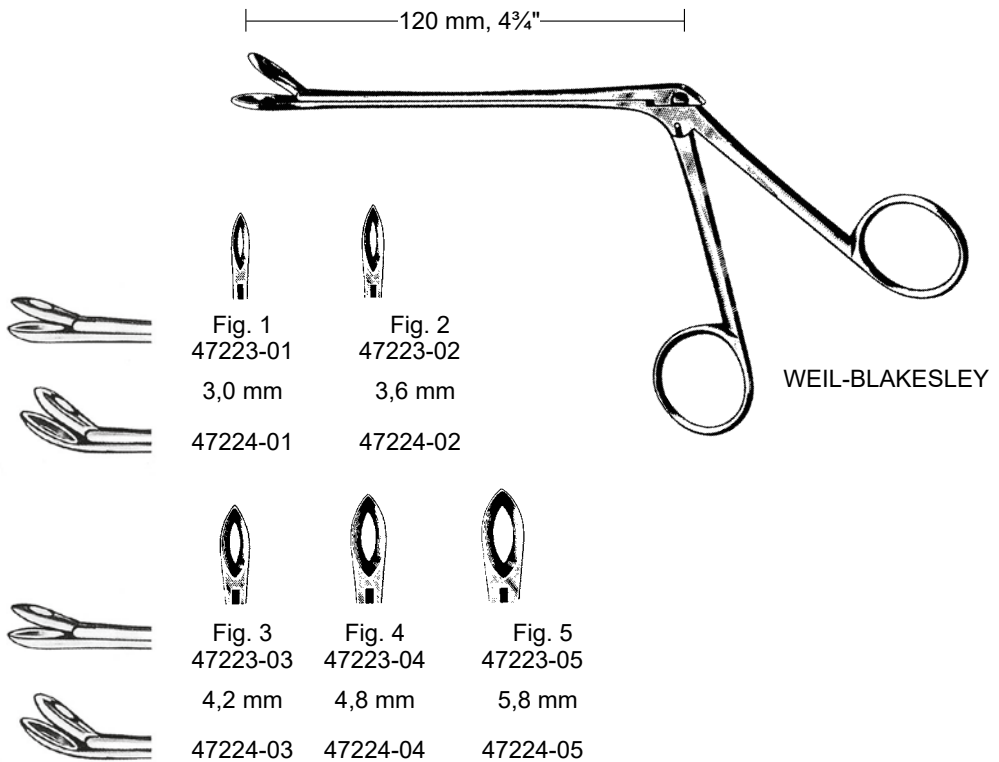

Hypophysen- und Tumorzangen
 Pituitary Rongeurs and Tumor Grasping Forceps
 Pinzas cortantes para hipófisis y para tumores
 Pinze per ipofisi e tumori



41445-25

180 mm / 7"

OLDBERG

Scharfe Hypophysenzange
 Sharp Pituitary Rongeur
 Pinza para hipófisis cortante
 Pinze per ipofisi tagliente



41446-02

190 mm / 7½"

LANDOLT

Scharfe Hypophysenzange
 Sharp Pituitary Rongeur
 Pinza para hipófisis cortante
 Pinze per ipofisi tagliente



41446-03

190 mm / 7½"

YASARGIL

Scharfe Hypophysenzange
 Sharp Pituitary Rongeur
 Pinza para hipófisis cortante
 Pinze per ipofisi tagliente



41446-09

200 mm / 8"

LANDOLT

Tumor-Faßzange, stumpf
 Tumor Grasping Forceps, blunt
 Pinza para tumores, roma
 Pinze per ipofisi smussa

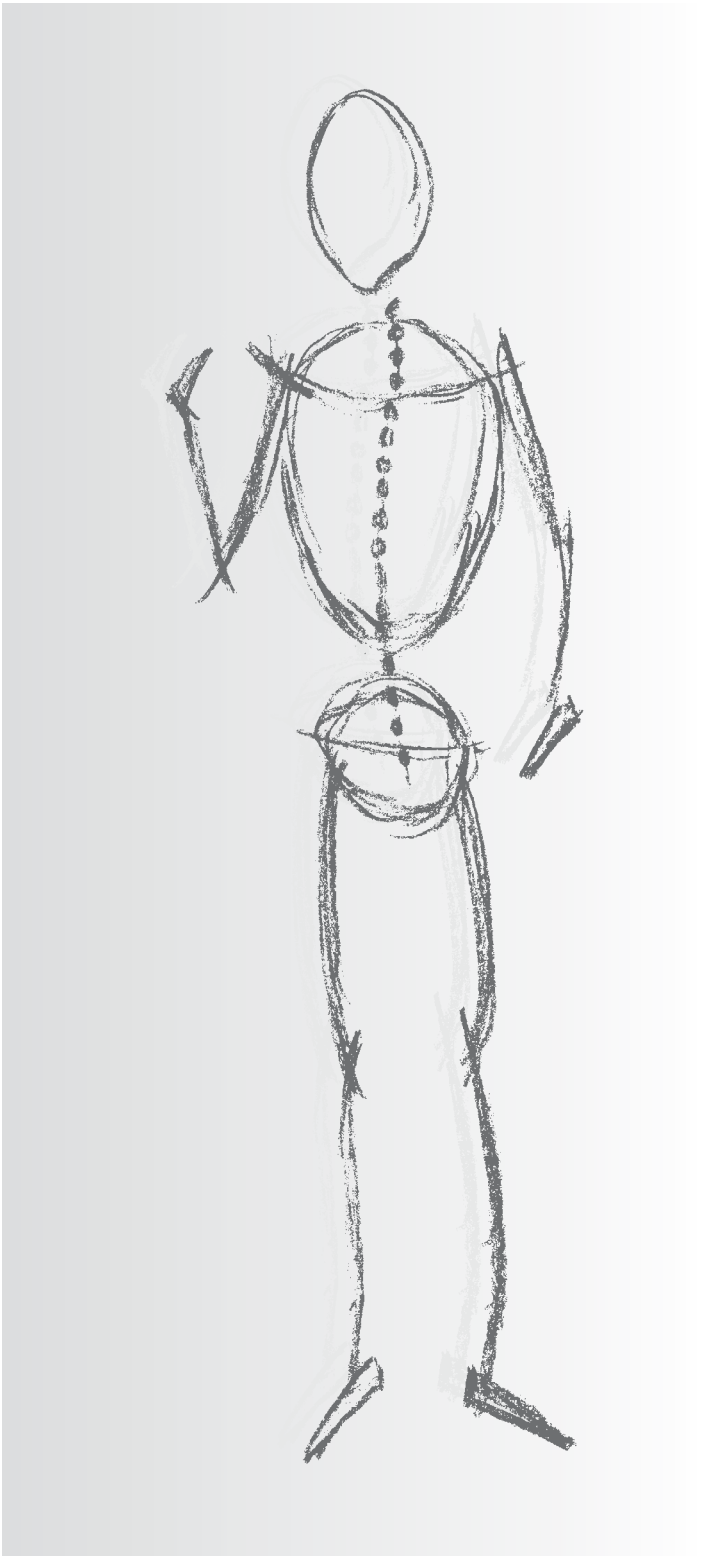

Reda Instrumente GmbH
Gänsäcker 34 - P.O. Box 131
D-78532 Tuttlingen

**MIKRO-RUNDGRIFF-
INSTRUMENTE**

**MICRO INSTRUMENTS
WITH ROUND HANDLE**

**INSTRUMENTOS PARA
MICROCIRUGÍA CON
MANGOS REDONDOS**

**STRUMENTI PER
MICROCHIRURGIA CON
MANICO ROTONDO**

Mikro Gefäßmesser
 Micro Vessel Knives
 Micro cuchillos
 Micro coltelli per vasi



41230-01 185 mm / 7¼" KOOS



41230-02 185 mm / 7¼" KOOS



41230-03 185 mm / 7¼" KOOS



41230-05 185 mm / 7¼" YASARGIL



41230-06 185 mm / 7¼" YASARGIL

Messer, Haken, Sonden
Knives, Hooks, Probes
Bisturies, Ganchos, Sondas
Bisturi, Uncino, Sonde

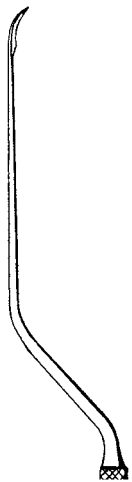

KOOS
41231-19
19 cm, 7½"

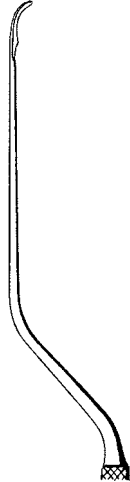

KOOS
41232-19
19 cm, 7½"

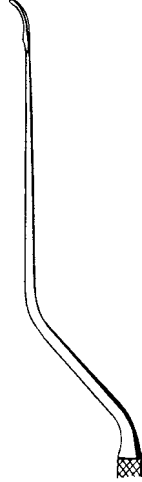

KOOS
41233-19
19 cm, 7½"

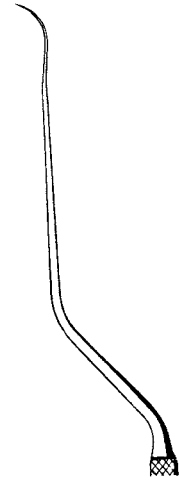

KOOS
41234-19
19 cm, 7½"



FISCH
41236-19
19 cm, 7½"

Durahaken
Dura Hook
Ganchito para dura-madre
Uncino dura madre



FISCH
41237-19
19 cm, 7½"

Feines Hákchen
Delicate Hook
Ganchito muy fino
Uncino molto fino



JACOBSON
41238-19
19 cm, 7½"

Knopfsonde
Buttoned Probe
Sonda abotonada
Sonda bottonuta



JACOBSON
41239-19
19 cm, 7½"

Doppelsonde
Twin Probe
Sonda doble
Sonda doppia

Gefäßdilatoren, Gefäßspreizer
Vessel dilators, Vessel Spreader
Dilatadores vasculares, Separador para vasos
Dilatatori vascolari, Divaricatore per vasi

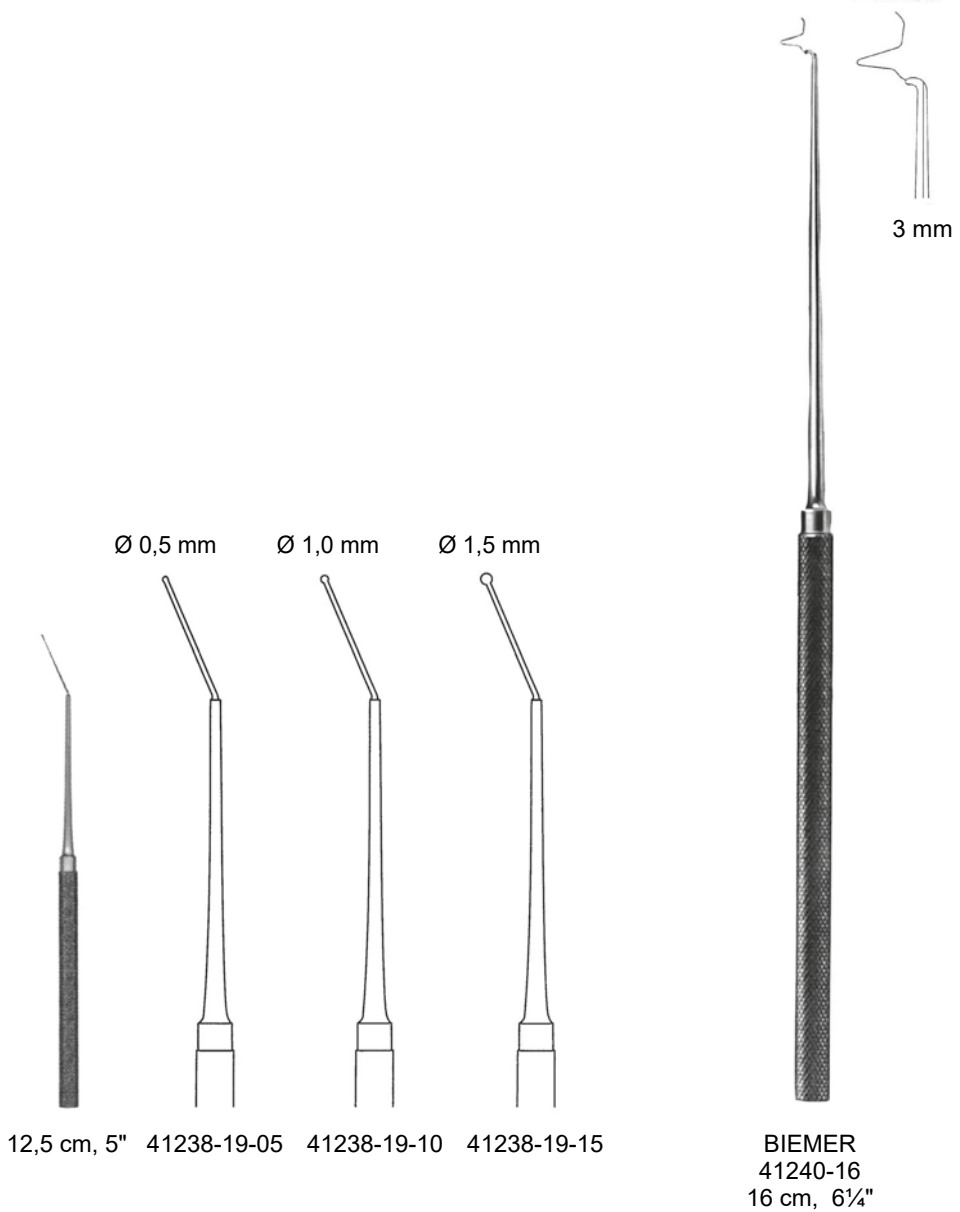

Tumormesser
Knives for tumor tissue
Cuchillos para tumores
Coltelli per tumori



SAMII



1,0 mm

93460-20 200 mm / 8"
93460-23 230 mm / 9"



1,5 mm

93461-20 200 mm / 8"
93461-23 230 mm / 9"



2,0 mm

93462-20 200 mm / 8"
93462-23 230 mm / 9"



2,5 mm

93463-20 200 mm / 8"
93463-23 230 mm / 9"



3,0 mm

93464-20 200 mm / 8"
93464-23 230 mm / 9"

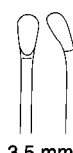

3,5 mm

93465-20 200 mm / 8"
93465-23 230 mm / 9"



4,0 mm

93466-20 200 mm / 8"
93466-23 230 mm / 9"



5,0 mm

93467-20 200 mm / 8"
93467-23 230 mm / 9"

Tumormesser
Knives for tumor tissue
Cuchillos para tumores
Coltelli per tumori



SAMII

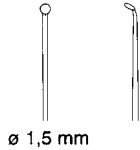

93470-20 200 mm / 8"
93470-23 230 mm / 9"

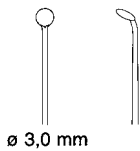

93471-20 200 mm / 8"
93471-23 230 mm / 9"

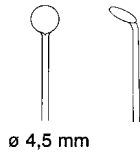

93472-20 200 mm / 8"
93472-23 230 mm / 9"

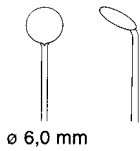

93473-20 200 mm / 8"
93473-23 230 mm / 9"

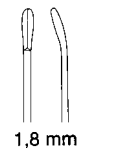

93474-23 230 mm / 9"
Lanzettenmesser
Lancet knives
Cuchillo lanceolar
Coltelli lanceolari

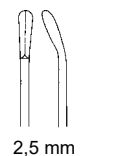

93475-23 230 mm / 9"
Lanzettenmesser
Lancet knives
Cuchillo lanceolar
Coltelli lanceolari

Fadengabel
Suture Pusher
Empujadores de suturas
Sonda Condutrice a forchetta



93500-18 185 mm / 7¼" JACOBSON

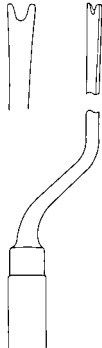

93501-23 230 mm / 9" CASPAR

Tumorgabeln
Tumor Forks
Horquillas para tumores
Forchetta per tumori



OKONEK-YASARGIL
23 cm, 9"

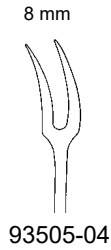
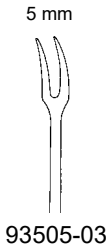
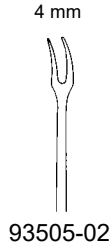
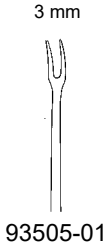

YASARGIL
20 cm, 8"



Gewebekralle
Tissue Pick
Garra para tejido
Uncini per tessuti

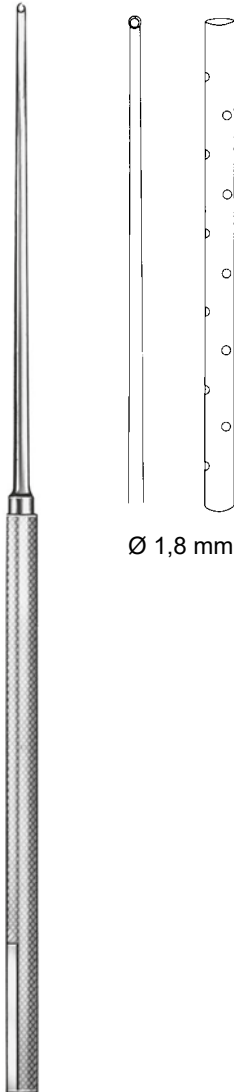

Ø 1,8 mm

mit Schutzkappe
with guard
con protector
con capuccio di protezione

93510-18
185 mm, 7¼"

Mikro-Rundgriffinstrumente
 Micro Instruments with round Handle
 Instrumentos para microcirugía con mangos redondos
 Strumenti per Microchirurgia con manico rotondo



41170-01
 Ø 1 mm
 Raspatorium
 Raspatories
 Legra
 Periostotomi

41170-07
 Ø 1,2 mm
 Dissektor
 Dissector
 Disector
 Dissettore

41170-11
 2 mm 90°
 Häkchen, halbscharf
 Hook, semi-sharp
 Gancho, semi agudo
 Gancio, semiacuto

41170-02
 Ø 2 mm
 Raspatorium
 Raspatories
 Legra
 Periostotomi

41170-08
 Ø 2,8 mm
 Dissektor
 Dissector
 Disector
 Dissettore

41170-12
 2 mm 90°
 Häkchen, stumpf
 Hook, blunt
 Gancho, romo
 Gancio, smusso

41170-03
 Ø 3 mm
 Raspatorium
 Raspatories
 Legra
 Periostotomi

41170-13
 3 mm 45°
 Häkchen, halbscharf
 Hook, semi-sharp
 Gancho, semi agudo
 Gancio, semiacuto

41170-04
 Ø 1 mm
 Dissektor, spatelförmig
 Dissector, spatula
 Disector, espatulado
 Dissettore, spatulate

41170-05
 Ø 1,5 mm
 Dissektor, spatelförmig
 Dissector, spatula
 Disector, espatulado
 Dissettore, spatulate

41170-09
 1 x 2 mm
 Scharfe Löffel, oval
 Curette, oval
 Cucharilla, oval
 Curette, ovale

41170-14
 Nadel, halbscharf
 Needle, semi-sharp
 Aguja, semi agudo
 Ago, semiacuto

41170-06
 Ø 2 mm
 Dissektor, spatelförmig
 Dissector, spatula
 Disector, espatulado
 Dissettore, spatulate

41170-10
 1 x 2 mm 45°
 Scharfe Löffel, oval
 Curette, oval
 Cucharilla, oval
 Curette, ovale

41170-15
 90°
 Knopfsonde
 Buttoned probes
 Sonda abotonada
 Sonda bottonute

RHOTON
 19 cm, 7½"

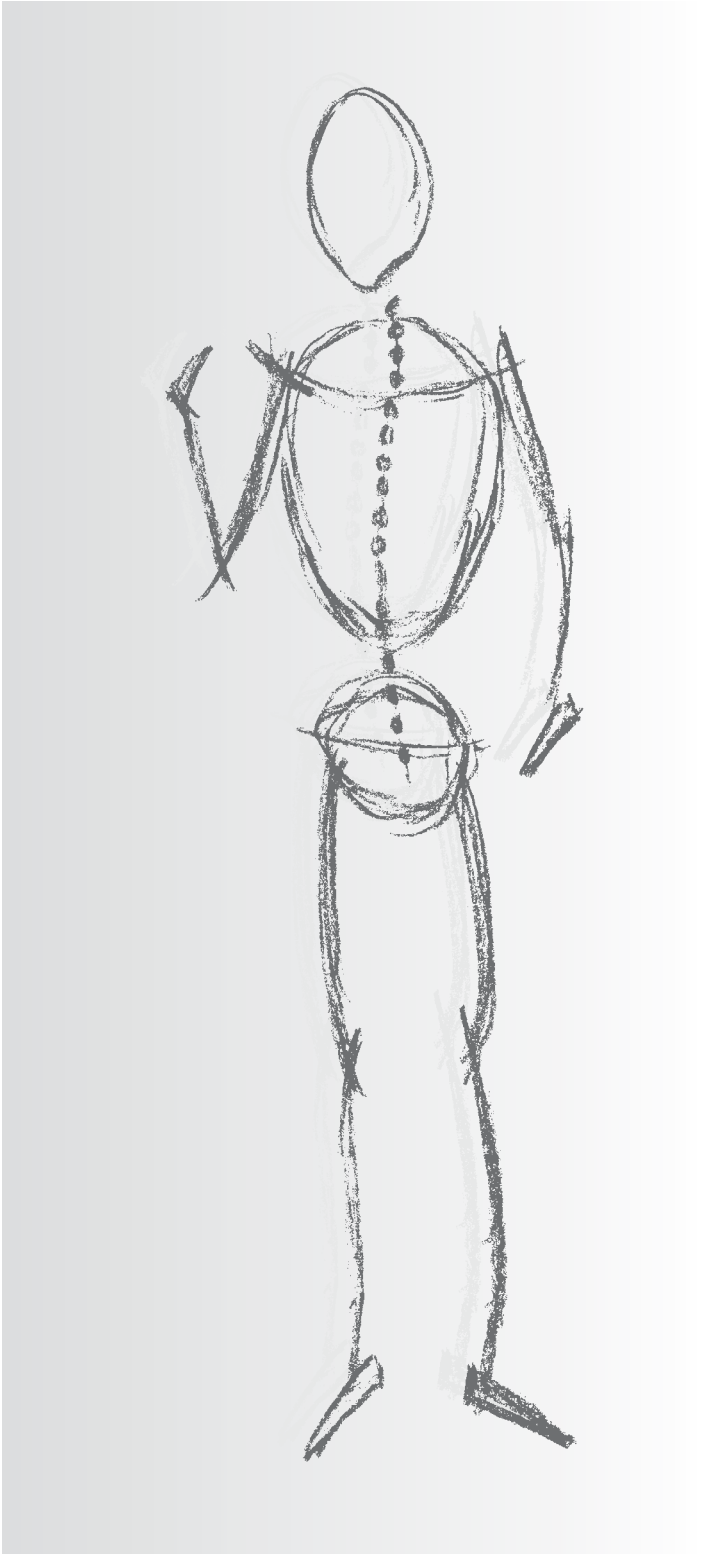

Reda Instrumente GmbH
Gänsäcker 34 - P.O. Box 131
D-78532 Tuttlingen

HYPOPHYSEKTOMIE

HYPOPHYSECTOMY

HIPOFISECTOMÍA

IPOFISECTOMIA

Ringküretten
Ring Curettes
Curetas anulares
Curette anulari

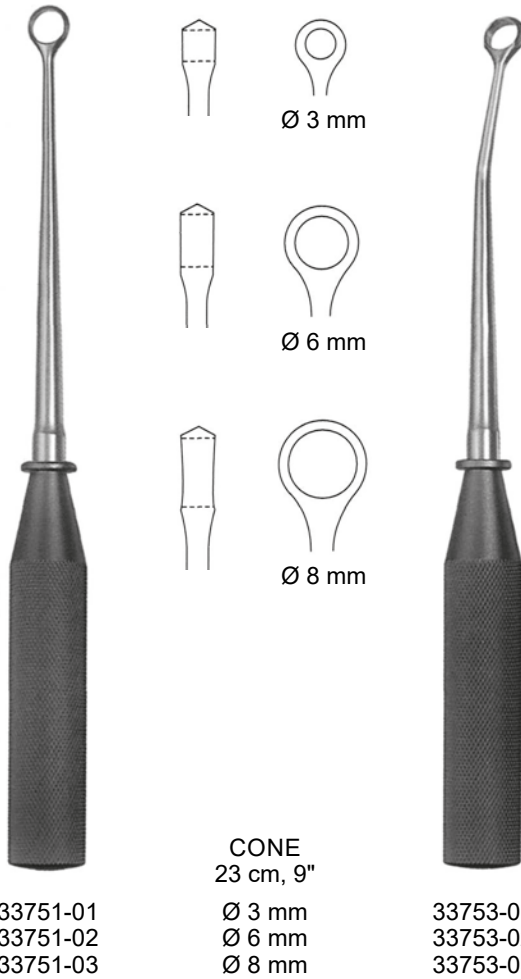

Hypophyse Pinzetten
Hypophyseal Forceps
Pinzas para hipófisis
Pinze per ipofisi



ADSON
41210-23
23 cm, 9"



ADSON
41213-23
23 cm, 9"

ADSON
41211-23
23 cm, 9"

Küretten
Curette
Curetas
Curette



41221-00
19 cm, 7½"



41222-00
19 cm, 7½"

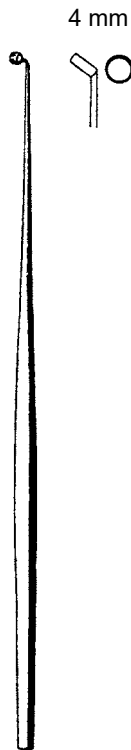

41223-00
19 cm, 7½"

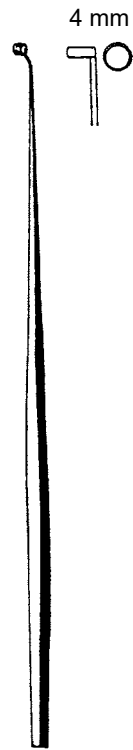

41224-00
19 cm, 7½"

Hypophysektomie Instrumente
Pituitary Instruments
Instrumentos para hipófisis
Strumenti per ipofisi



CUSHING-LANDOLT

93600-01 70 x 15 mm

93600-02 90 x 15 mm

93600-03 110 x 15 mm

Spekula für trans-sphenoidale Hypophysektomie
specula for trans-sphenoidale hypophysectomy
especulos para hipofisectomía transfenoidal
specoli per ipofisectomia trasfenoidale



Spreizzange zum Spreizen der Spekula
spreader for specula
pinza para abrir el especulo
pinze per aprire gli specoli

LANDOLT
93605-21
210 mm, 8¼"

Hypophysektomie Instrumente
 Pituitary Instruments
 Instrumentos para hipófisis
 Strumenti per ipofisi



PAPAVERO-CASPAR
 93610-11 80 x 11 mm
 93610-13 90 x 13 mm
 93610-15 100 x 15 mm

Spekula für trans-sphenoidale Hypophysektomie
 specula for trans-sphenoidale hypophysectomy
 espéculos para hipofisectomía trasfenoidal
 specoli per ipofisectomia trasfenoidale



PAPAVERO-HARTMANN
 93615-01
 140 mm, 5½"

Spreizer für Spekula
 spreader for specula
 pinza para abrir el espéculo
 pinze per aprire gli specoli

140 mm, 5½"



LANDOLT
 93620-14
 215 mm, 8 ½"

Hypophysektomie-Instrumente
 Pituitary Instruments
 Instrumentos para hipófisis
 Strumenti per ipofisi

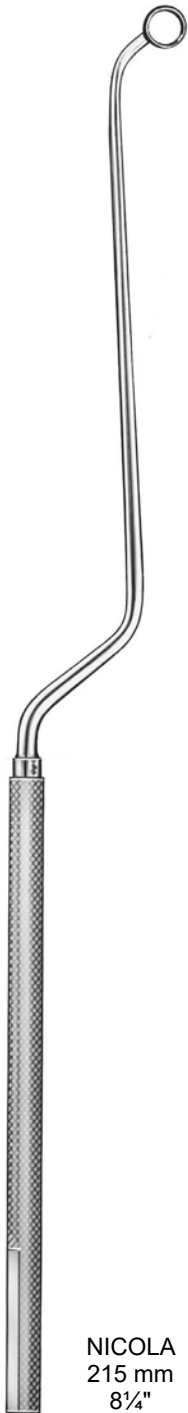

NICOLA
 215 mm
 8 1/4"

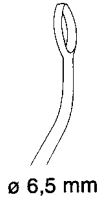

93660-01

Kürette, biegsam, nach rechts schneidend
 curette, malleable, cutting to the right
 cureta, maleable, cortante hacia la derecha
 curetta, malleabile, tagliente a destra

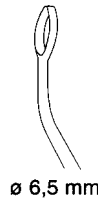

93660-02

Kürette, biegsam, nach links schneidend
 curette, malleable, cutting to the left
 cureta, maleable, cortante hacia la izquierda
 curetta, malleabile, tagliente a sinistra



93660-03

Kürette, biegsam
 curette, malleable
 cureta, maleable
 curetta, malleabile

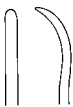

93660-04

Raspatorium
 raspatory
 legra
 raspatore

Hypophysektomie-Instrumente
 Pituitary Instruments
 Instrumentos para hipófisis
 Strumenti per ipofisi



	93670-01	245 mm / 9 ³ / ₄ "	rechts/right/derecha/a destra	HARDY
	93670-02	245 mm / 9 ³ / ₄ "	links/left/izquierda/a sinistra	
	Eukleator, stumpf enucleator, blunt enucleador, romo enucleatore, smusso			
	93670-05	245 mm / 9 ³ / ₄ "	rechts/right/derecha/a destra	HARDY
	93670-06	245 mm / 9 ³ / ₄ "	links/left/izquierda/a sinistra	
	Eukleator, scharf enucleator, sharp enucleador, cortante enucleatore, tagliente			
	93670-09	245 mm / 9 ³ / ₄ "	HARDY	
	Implantationsgabel implant fork horquilla de implante forchetta per trapianti			
	93670-10	245 mm / 9 ³ / ₄ "	HARDY-FAHLBUSCH	
	Dissektor, innen scharf dissector sharpened inner edge disector, lado interno cortante dissettore, lato interno sinistro tagliente			
	93670-12	245 mm / 9 ³ / ₄ "	HARDY-FAHLBUSCH	
	Dissektor, innen scharf dissector sharpened inner edge disector, lado interno cortante dissettore, lato interno destro tagliente			

Hypophysektomie-Instrumente
 Pituitary Instruments
 Instrumentos para hipófisis
 Strumenti per ipofisi



93680-01 260 mm / 10³/₄" LANDOLT
 rechts/right/derecha/a destra

93680-02 260 mm / 10³/₄"
 links/left/izquierda/a sinistra

Enukleator, stumpf, biegsam
 enucleator, blunt, malleable
 enucleador, romo, maleable
 enucleatore, smusso, malleabile

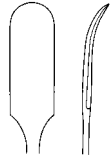

93680-05 260 mm / 10³/₄" LANDOLT

Kürette, biegsam
 curette, malleable
 cureta, maleable
 curetta, malleabile

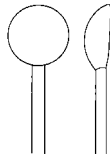

93680-06 260 mm / 10³/₄" LANDOLT

Löffel, biegsam
 scoop, malleable
 cucharilla, maleable
 cucchiaio, malleabile



93680-07 260 mm / 10³/₄" LANDOLT

stumpfes Häkchen, biegsam
 blunt hook, malleable
 gancho, romo, maleable
 uncino smusso, malleabile



93690-01 260 mm / 10³/₄" HOSOBUCHI

gabelförmige Spatel, fest
 fork spatula, rigid
 espatula forma horquilla, rígida
 spatola forma a forchetta, rigida

Hypophysenküretten
 Pituitary Cures
 Cureta para hipófisis
 Curetta per ipofisi

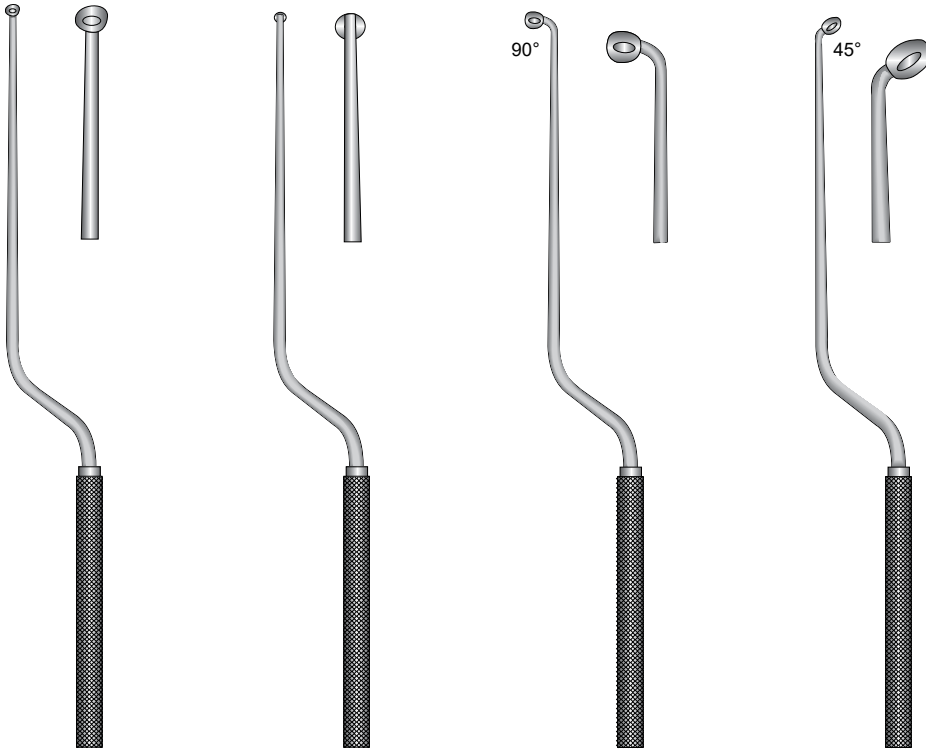

HARDY

24 cm, 9½"

93700-03 3 mm

93700-05 5 mm

aufwärts gewinkelt
 angled up
 en ángulo hacia arriba
 angolato verso l'alto

HARDY

24 cm, 9½"

93701-03 3 mm

93701-05 5 mm

abwärts gewinkelt
 angled down
 ángulo hacia abajo
 angolato verso il basso

HARDY

24 cm, 9½"

93702-03 3 mm

93702-05 5 mm

links gewinkelt
 left curved
 curvo hacia la izquierda
 curva a destra

HARDY

24 cm, 9½"

93703-03 3 mm

93703-05 5 mm

rechts gewinkelt
 right curved
 curvo hacia la derecha
 curva a sinistra

Hypophysektomie-Instrumente
Pituitary Instruments
Instrumentos para hipófisis
Strumenti per ipofisi



HARDY
93704-24
23,5 cm, 9¼"

Löffel, biegsam
Spoon, malleable
Cucharilla, maleable
Cucchiaio, malleabile

5 mm





HARDY
93705-00
23 cm, 9"

Mikrospiegel
Micro mirror
Micro espejo
Micro-specchio

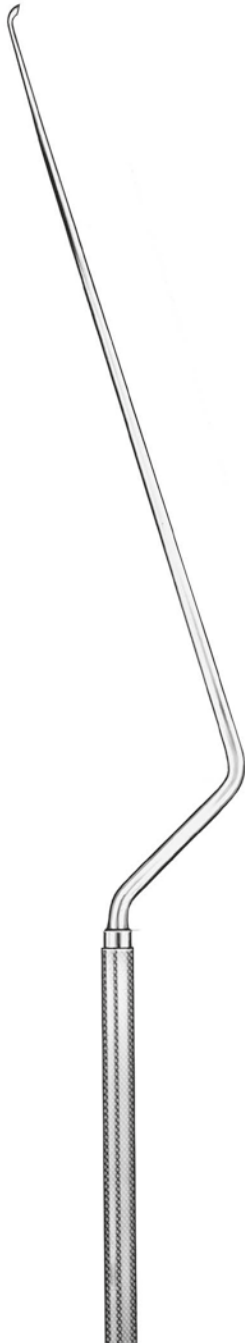
Hypophysektomie-Instrumente
 Pituitary Instruments
 Instrumentos para hipófisis
 Strumenti per ipofisi

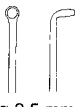
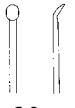
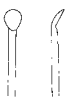
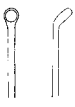

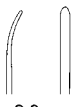
- | | | | |
|---|----------|---------------|--|
|  | 93710-01 | 260 mm / 10¼" | FAHLBUSCH |
| | | | Löffel, biegsam
scoop, malleable
cucharilla, maleable
cucchiaio, malleabile |
|  | 93710-02 | 260 mm / 10¼" | FAHLBUSCH |
| ø 2,5 mm | | | Kürette, biegsam
curette, malleable
cureta, maleable
curetta, malleabile |
|  | 93710-03 | 260 mm / 10¼" | LANDOLT-REULEN |
| ø 2,2 mm | | | Raspatorium, fest
raspatories, rigid
legra, rígida
raspatore, rigido |
|  | 93710-04 | 260 mm / 10¼" | LANDOLT-REULEN |
| ø 3,2 mm | | | Raspatorium, fest
raspatories, rigid
legra, rígida
raspatore, rigido |
|  | 93710-05 | 260 mm / 10¼" | LANDOLT-REULEN |
| ø 2,5 mm | | | Kürette, fest
curette, rigid
cureta, rígida
curetta, rigido |
|  | 93710-06 | 260 mm / 10¼" | LANDOLT-REULEN |
| 1,7 mm | | | stumpfes Hákchen, fest
blunt hook, rigid
gancho, romo, rígido
uncino smusso, rigida |
|  | 93710-07 | 260 mm / 10¼" | LANDOLT-REULEN |
| 2,0 mm | | | Dissektor, fest
dissector, rigid
disector, rigido
dissetto, rigida |

Hypophysektomie-Instrumente
 Pituitary Instruments
 Instrumentos para hipófisis
 Strumenti per ipofisi

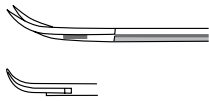
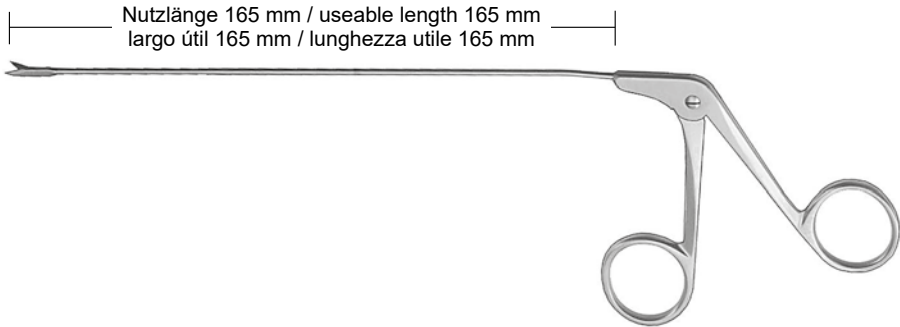

93720-01 165 mm / 6½" FAHLBUSCH
 Mikro-Schere, gebogen, horizontal schneidend
 Micro scissors, horizontal cutting
 Micro-tijera, curva, cortante en forma horizontal
 Micro forbice, curva, tagliente orizzontale

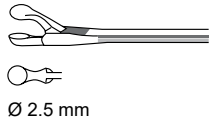

93720-02 165 mm / 6½" NICOLA
 Scharfe Zange
 Forceps scoop-shaped
 Pinza en forma de cuchara, cortante
 Pinze tagliente

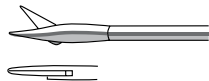

93720-03 165 mm / 6½" NICOLA
 Mikro-Schere, gerade
 Micro Scissors, straight
 Micro-tijera, recta
 Micro forbice, retta

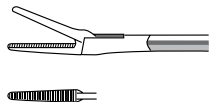

93720-04 165 mm / 6½" YASARGIL-NICOLA
 Faßzange
 Grasping Forceps
 Pinza de agarre
 Pinze da presa

Hypophysektomie-Instrumente
 Pituitary Instruments
 Instrumentos para hipófisis
 Strumenti per ipofisi

Nutzlänge 80 mm / useable length 80 mm
 largo útil 80 mm / lunghezza utile 80 mm

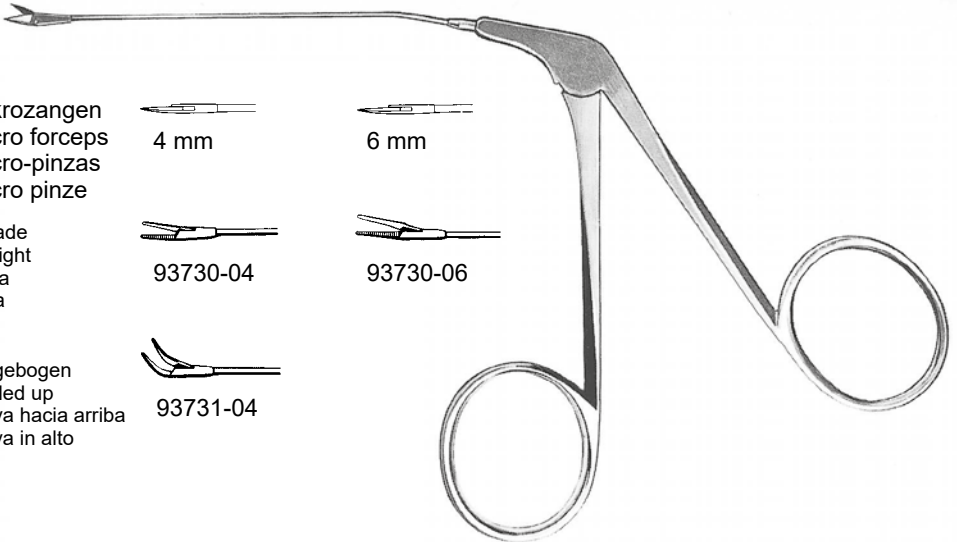

Mikrozangen
 Micro forceps
 Micro-pinzas
 Micro pinze



4 mm



6 mm

gerade
 straight
 recta
 retta



93730-04



93730-06

aufgebogen
 angled up
 curva hacia arriba
 curva in alto



93731-04

Löffelzangen
 Cup-shaped Forceps
 Pinzas en forma de cuchara
 Pinze, morso a forma di cucchiaio

gerade
 straight
 recta
 retta

rund
 round
 redondo
 rotondo



93740-01

oval
 oval
 oval
 ovale

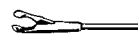

93740-02

Mikro-Scheren
 Micro Scissors
 Micro tijeras
 Micro Forbici

gerade
 straight
 recta
 retta



93750-01

rechts gebogen
 curved right
 curva hacia la derecha
 curva a destra



93750-03

aufgebogen
 angled up
 curva hacia arriba
 curva in alto



93750-02

links gebogen
 curved left
 curva hacia la izquierda
 curva a sinistra



93750-04

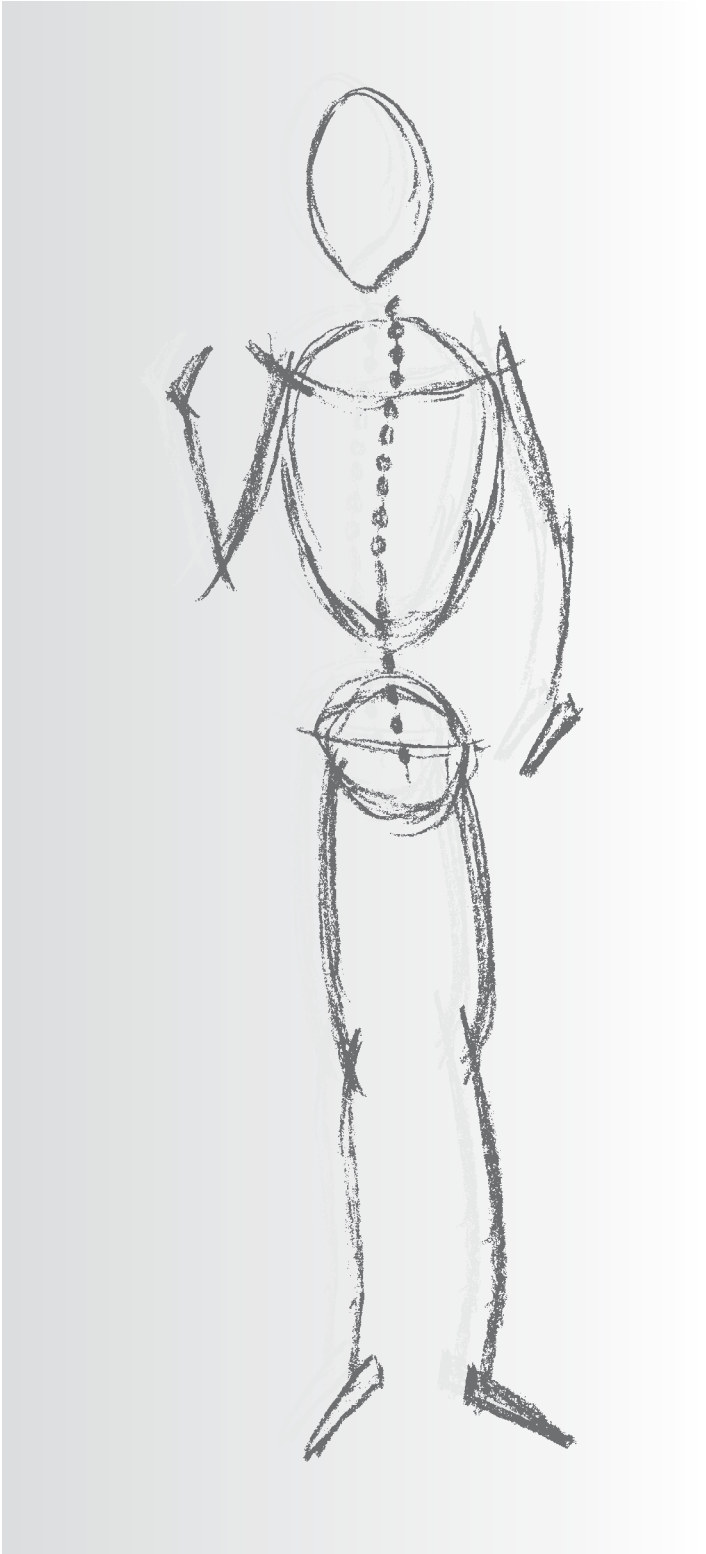

Reda Instrumente GmbH
Gänsäcker 34 - P.O. Box 131
D-78532 Tuttlingen

HIRNSPATEL

BRAIN SPATULAS

ESPÁTULAS CEREBRALES

SPATOLE CEREBRALI

Hirnspatel
Brain Spatulas
Espátulas cerebrales
Spatole cerebrali



biegsam
malleable
maleable
malleabile

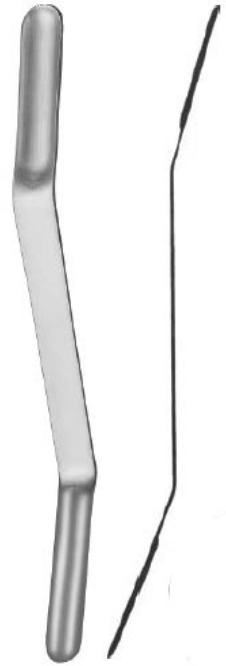

AACHEN

- 41249-07 7/8 x 200 mm
- 41249-10 10/11 x 200 mm
- 41249-13 13/14 x 200 mm
- 41249-16 16/17 x 200 mm
- 41249-19 19/20 x 200 mm
- 41249-22 22/25 x 200 mm

CUSHING

- 41250-11 8 x 10 mm
- 41250-15 13 x 15 mm
- 41250-18 16 x 18 mm

OLIVECRONA

- 41253-07 7/9 mm
- 41253-11 11/13 mm
- 41253-15 15/18 mm
- 41253-18 18/22 mm

Hirnspatel
Brain Spatulas
Espátulas cerebrales
Spatole cerebrali



biegsam
malleable
maleable
malleabile

DAVIS
18 cm, 7"

41254-06	6 mm
41254-10	9 mm
41254-13	13 mm
41254-16	16 mm
41254-19	19 mm
41254-25	25 mm
41254-32	32 mm
41254-38	38 mm

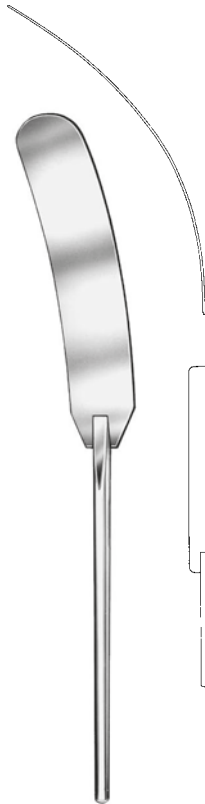

200 mm / 8"
41860-14 14 mm
41860-17 17 mm
41860-20 20 mm



155 mm / 6"
41870-08 8 mm
41870-11 11 mm
41870-14 14 mm
41870-17 17 mm

HEIFETZ

biegsam
malleable
maleable
malleabile



biegsam
malleable
maleable
malleabile

41880-01	9 x 200 mm, 8"
41880-02	12 x 200 mm, 8"
41880-03	12 x 250 mm, 10"

LEYLA Retraktor System
 LEYLA Retractor System
 Separador de sistema LEYLA
 LEYLA Sistema di fissaggio

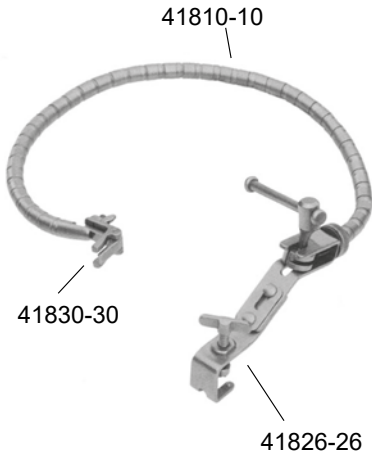

YASARGIL

41801-01 Hirnspatelhalter, flexibel, für 1 flachen Spatel, komplett, bestehend aus:
 brain retractor, flexible, for 1 flat spatula, complete, consisting of:
 separador autorententivo, flexible, para espátula con 1 brazo flexible, completo, compuesto de:
 divaricatore autostatico, flessibile, per spatole piatte, con 1 braccio flessibile, completo, composto da:

41810-10 flexibler Spannarm
 flexible arm
 brazo flexible
 braccio flessibile

41826-26 Fixiervorrichtung für 1 flexiblen Spannarm
 fixation base for 1 flexible arm
 fijador para 1 brazo flexible
 fissatore per 1 braccio al braccio rigido

41830-30 Spatelhalter für flache Spatel
 support for flat brain spatula
 soporte para espátulas cerebrales planas
 sostegno per spatole piatte

YASARGIL

41802-02 Hirnspatelhalter, flexibel für 2 flache Spatel, komplett, bestehend aus:
 brain retractor, flexible, for 2 flat spatulas, complete, consisting of:
 separador autorententivo, flexible, para 2 espátulas planas con 2 brazos flexibles, completo, compuesto de:
 divaricatore autostatico, flessibile, per spatole piatte, con 2 bracci flessibili, completo, composto da:



41810-10 flexibler Spannarm (2x)
 flexible arm (2x)
 brazo flexible (2x)
 braccio flessibile (2x)

41822-22 Fixiervorrichtung für 2 flexible Spannarme
 fixation base for 2 flexible arms
 fijador para 2 brazos
 fissatore per 2 bracci al cranio

41830-30 Spatelhalter für flache Spatel (2x)
 support for flat brain spatula (2x)
 soporte para espátulas cerebrales planas (2x)
 sostegno per spatole piatte (2x)

LEYLE Retraktor System
 LEYLE Retractor System
 Separador de sistema LEYLE
 LEYLE Sistema di fissaggio

41821-21

Fixiervorrichtung für 1 flexiblen Spannarm zum Festschrauben an Rohrteilen bis \varnothing 16 mm

Fixation base for mounting on bars up to \varnothing 16 mm, for 1 flexible arm

Fijador para 1 brazo flexible, para atornillar a tubos hasta 16 mm

Fissatore per 1 braccio al braccio rigido

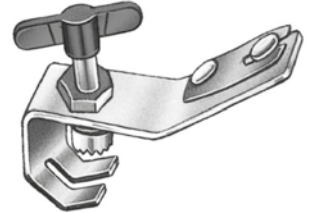

41822-22

Fixiervorrichtung für 2 flexible Spannarme zum Festschrauben am Schädel

Fixation base for skull mounting, holding 2 flexible arms

Fijador para 2 brazos flexibles, para atornillar al cráneo

Fissatore per 2 bracci al cranio



41826-26

Fixiervorrichtung für 1 flexiblen Spannarm zum Festschrauben am Schädel

Fixation base for skull mounting, holding 1 flexible arm

Fijador para 1 brazos flexibles, para atornillar al cráneo

Fissatore per 1 braccio al cranio

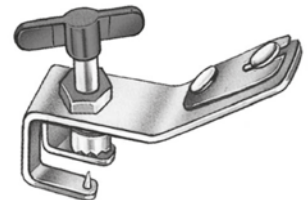

41830-30

Spatelhalter für flache Hirnspatel zur Befestigung am Spannarm

Support for flat brain spatula

Soporte para espátulas cerebrales planas para fijación al brazo flexible

Sostegno per spatole piatte



41832-32

Halter für Hirnspatel mit rundem Schaft bis \varnothing 5,5 mm zur Befestigung am Spannarm

Support for brain spatula with round shaft

Soporte para espátulas cerebrales con mango redondo hasta \varnothing 5,5 mm para

fijación al brazo flexible

Sostegno flessibile per spatola cerebrale



LEYLA Retraktor System
 LEYLA Retractor System
 Separador de sistema LEYLA
 LEYLA Sistema di fissaggio



YASARGIL

41810-10 flexibler Spannarm, allein
 flexible arm, only
 brazo flexible, suelto
 braccio flessibile, solo

YASARGIL

41803-01 Ohrspekulahalter, komplett, bestehend aus:
ear specula holder, complete, consisting of:
soporte para espejos auriculares completo,
compuosto de:
 sostegno per specchio auricolare, completo
 composto da:

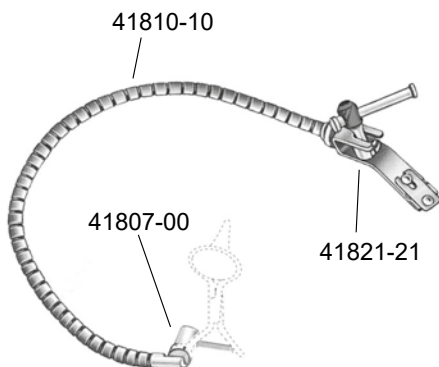

41810-10 flexibler Spannarm
 flexible arm, only
 brazo flexible, suelto
 braccio flessibile, solo

41821-21 Fixiervorrichtung zum Befestigen an Rohrteilen
bis Ø 16 mm
clamp for fixation on bars up to Ø 16 mm
fijador para 1 brazo flexible, para atornillar a
tubos hasta 16 mm
fissatore al braccio rigido Ø 16 mm

41807-00 Ohrtrichterhalter, allein
 ear specula holder, only
 soporte para espejos auriculares, suelto
 sostegno per specchio auricolare

LEYLA Retraktor System
 LEYLA Retractor System
 Separador de sistema LEYLA
 LEYLA Sistema di fissaggio

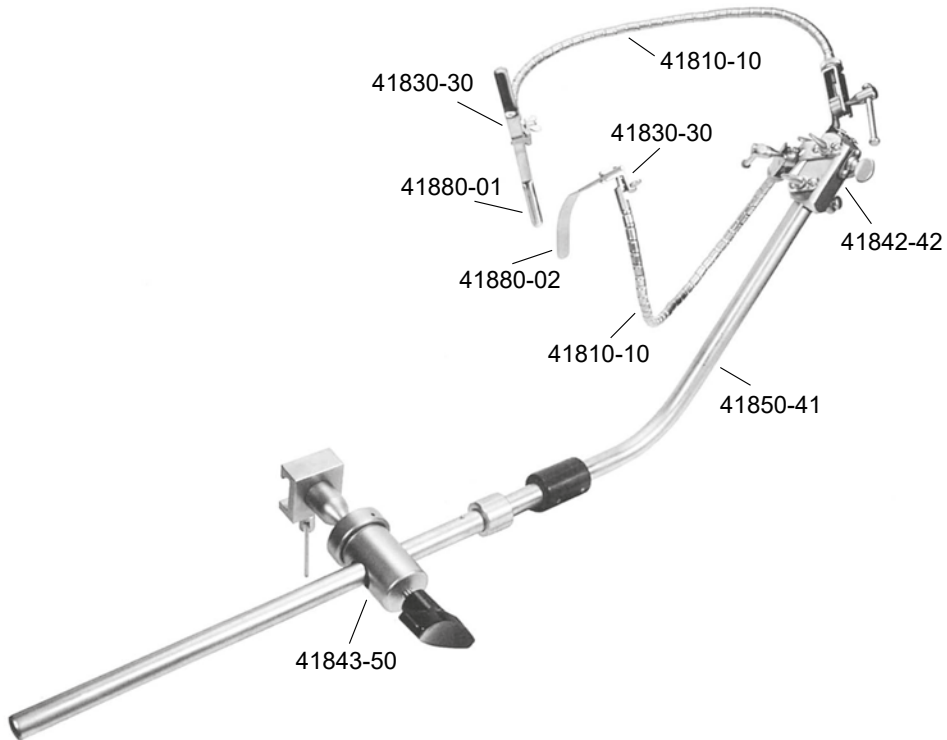

41802-00 LEYLA-Retraktor-System zum Fixieren am OP-Tisch komplett, bestehend aus:
 LEYLA Self-Retraining Retractor for fixation to operating table, complete, consisting of:
 Separador LEYLA para fijacion a la mesa de operaciones, completo, compuesto de:
 LEYLA Sistema di fissaggio al tavolo operatorio, composto da:

- | | |
|---|--|
| 41843-50 Kugelgelenkkloben (1x)
ball and socket joint (1x)
articulacion esferica (1x)
giunto per fissare (1x) | 41830-30 Spatelhalter für flache Spatel (2x)
support for flat brain spatula (2x)
soporte para espátulas cerebrales planas (2x)
sostegno per spatole piatte (2x) |
| 41850-41 starrer Haltearm (1x)
rigid holding rod (1x)
brazo de fijación rigido (1x)
braccio di fissaggio rigido (1x) | 41880-01 CUSHING Hirnspatel (1x)
CUSHING brain spatula (1x)
CUSHING espatula para cerebro (1x)
CUSHING spatola cerebrale (1x) |
| 41842-42 Kupplungskopf (1x)
coupling head (1x)
cabeza de acoplamiento (1x)
giunto per combinare (1x) | 41880-02 CUSHING Hirnspatel (1x)
CUSHING brain spatula (1x)
CUSHING espatula para cerebro (1x)
CUSHING spatola cerebrale (1x) |
| 41810-10 flexibler Spannarm (2x)
flexible arm, only (2x)
brazo flexible, suelto (2x)
braccio flessibile, solo (2x) | |

LEYLA Retraktor System
 LEYLA Retractor System
 Separador de sistema LEYLA
 LEYLA Sistema di fissaggio



- 41843-50 Kugelgelenkkloben zum Befestigen an der OP-Tischschiene und zur Aufnahme des Haltearms 41850-41
 ball and socket joint for fixation of holding rod 41850-41 at the operating table
 articulacion esferica, para sujetar el brazo de soporte rigido sobre la mesa de operaciones 9 x 32 mm
 giunto per fissare il braccio, articolato 9 x 32 mm



- 41850-41 starrer Haltearm, auseinandernehmbar, zur Fixation im Kugelgelenkkloben 41843-50 und zur wahlweisen Aufnahme der Kupplungsköpfe 41842-42, 41842-44 und 41842-46
 holding rod, detachable, for fixation in ball and socket joint 41843-50 and to hold a desired coupling head 41842-42, 41842-44 or 41842-46
 brazo de soporte rigido, desmontable, para fijacion a la articulacion esferica 41843-50 y opcionalmente a las cabezas 41842-42, 41842-44 y 41842-46
 braccio di sostegno rigido, per fissaggio al giunto 41843-50 e dei giunti 41842-42, 41842-44 e 41842-46

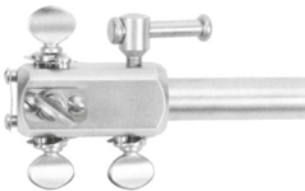

- 41842-42 Kupplungskopf, zur Aufnahme von max. 5 flexiblen Spannarmen 41810-10
 coupling head to hold 5 flexible arms 41810-10
 cabeza de acoplamiento para fijar hasta 5 brazos flexibles
 giunto per combinare 5 bracci



- 41842-44 Kupplungskopf, drehbar, zur Aufnahme von 1 flexiblen Spannarm 41810-10
 coupling head, turnable, to hold 1 flexible arm 41810-10
 acoplamiento, girable y se puede fijar en todas las posturas para sujetar un brazo flexible 41810-10
 giunto per combinare, rotabile, per sostegno del braccio 41810-10

- 41842-46 Kupplungskopf, seitlich offen zur Aufnahme von 1 flexiblen Spannarm 41810-10
 coupling head, lateral open, to hold 1 flexible arm 41810-10
 acoplamiento, abierto al lado, para un brazo flexible 41810-10
 giunto per fissare il braccio, per 41810-10

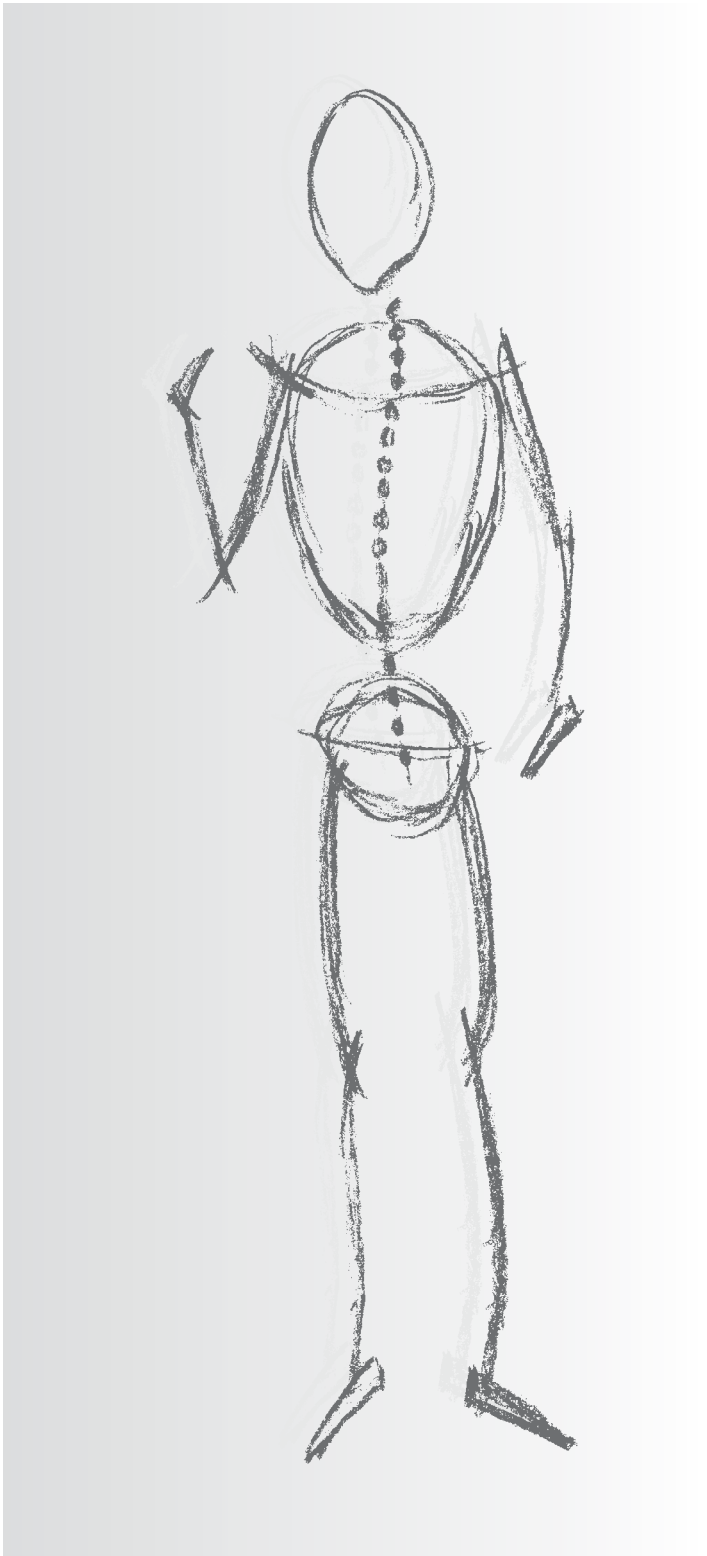

Reda Instrumente GmbH
Gänsäcker 34 - P.O. Box 131
D-78532 Tuttlingen

STANZEN

PUNCHES

PINZAS SACABOCADO

PINZE LAMINOTOMO

Bandscheibenstanzen
 Intervertebral Disc Rongeurs
 Pinzas sacabocado para discos intervertebrales
 Pinze taglienti per dischi intervertebrali

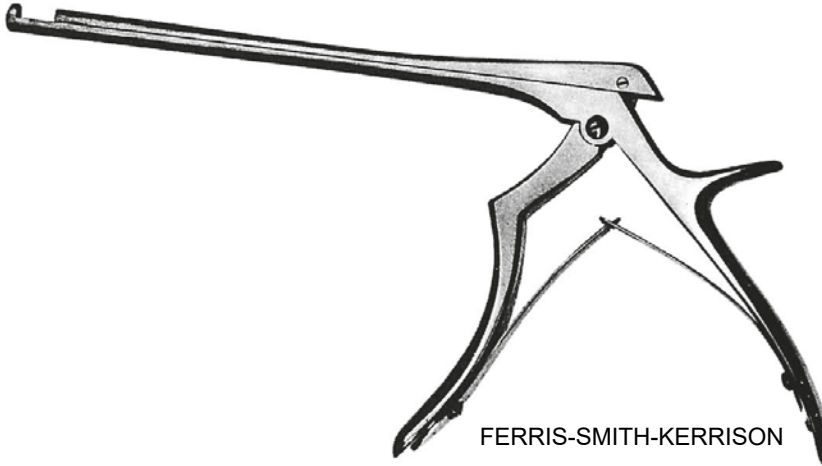

	90°		90°		90°		45°		45°
18 cm, 7"	41510-01	1 mm	41511-01	1 mm	41512-01	1 mm	41512-01	1 mm	41512-01
20 cm, 8"	41513-01	1 mm	41514-01	1 mm	41515-01	1 mm	41515-01	1 mm	41515-01
23 cm, 9"	41513-01-23	1 mm	41514-01-23	1 mm	41515-01-23	1 mm	41515-01-23	1 mm	41515-01-23
18 cm, 7"	41510-02	2 mm	41511-02	2 mm	41512-02	2 mm	41512-02	2 mm	41512-02
20 cm, 8"	41513-02	2 mm	41514-02	2 mm	41515-02	2 mm	41515-02	2 mm	41515-02
23 cm, 9"	41513-02-23	2 mm	41514-02-23	2 mm	41515-02-23	2 mm	41515-02-23	2 mm	41515-02-23
18 cm, 7"	41510-03	3 mm	41511-03	3 mm	41512-03	3 mm	41512-03	3 mm	41512-03
20 cm, 8"	41513-03	3 mm	41514-03	3 mm	41515-03	3 mm	41515-03	3 mm	41515-03
23 cm, 9"	41513-03-23	3 mm	41514-03-23	3 mm	41515-03-23	3 mm	41515-03-23	3 mm	41515-03-23
18 cm, 7"	41510-04	4 mm	41511-04	4 mm	41512-04	4 mm	41512-04	4 mm	41512-04
20 cm, 8"	41513-04	4 mm	41514-04	4 mm	41515-04	4 mm	41515-04	4 mm	41515-04
23 cm, 9"	41513-04-23	4 mm	41514-04-23	4 mm	41515-04-23	4 mm	41515-04-23	4 mm	41515-04-23
18 cm, 7"	41510-05	5 mm	41511-05	5 mm	41512-05	5 mm	41512-05	5 mm	41512-05
20 cm, 8"	41513-05	5 mm	41514-05	5 mm	41515-05	5 mm	41515-05	5 mm	41515-05
23 cm, 9"	41513-05-23	5 mm	41514-05-23	5 mm	41515-05-23	5 mm	41515-05-23	5 mm	41515-05-23

auch lieferbar mit Dünnpfuß und/oder mit Auswerfer
 also available with thin foot plate and/or with ejector
 tambien disponible con lámina de punzonar estrecha y/o con expulsor
 anche disponibile con morso sottile e/o con espulsore

Bandscheibenstanzen
 Intervertebral Disc Rongeurs
 Pinzas sacabocado para discos intervertebrales
 Pinze taglianti per dischi intervertebrali

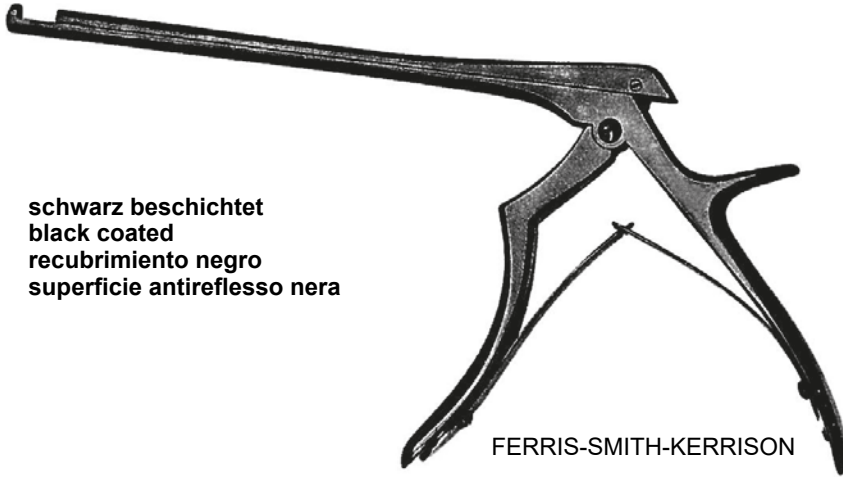

schwarz beschichtet
black coated
recubrimiento negro
superficie antireflesso nera

FERRIS-SMITH-KERRISON

	90°		45°
18 cm, 7"	41510-01B 1 mm		41512-01B 1 mm
20 cm, 8"	41513-01B 1 mm		41515-01B 1 mm
23 cm, 9"	41513-01-23B 1 mm		41515-01-23B 1 mm
18 cm, 7"	41510-02B 2 mm		41512-02B 2 mm
20 cm, 8"	41513-02B 2 mm		41515-02B 2 mm
23 cm, 9"	41513-02-23B 2 mm		41515-02-23B 2 mm
18 cm, 7"	41510-03B 3 mm		41512-03B 3 mm
20 cm, 8"	41513-03B 3 mm		41515-03B 3 mm
23 cm, 9"	41513-03-23B 3 mm		41515-03-23B 3 mm
18 cm, 7"	41510-04B 4 mm		41512-04B 4 mm
20 cm, 8"	41513-04B 4 mm		41515-04B 4 mm
23 cm, 9"	41513-04-23B 4 mm		41515-04-23B 4 mm
18 cm, 7"	41510-05B 5 mm		41512-05B 5 mm
20 cm, 8"	41513-05B 5 mm		41515-05B 5 mm
23 cm, 9"	41513-05-23B 5 mm		41515-05-23B 5 mm

auch lieferbar mit Dünnfuß und/oder mit Auswerfer
 also available with thin foot plate and/or with ejector
 tambien disponible con lámina de punzonar estrecha y/o con expulsor
 anche disponibile con morso sottile e/o con espulsore

Bandscheibenstanzen, zerlegbar
 Intervertebral Disc Rongeurs, dismantable
 Pinzas sacabocado para discos intervertebrales, desmontable
 Pinze taglianti per dischi intervertebrali, smontabile a fucile

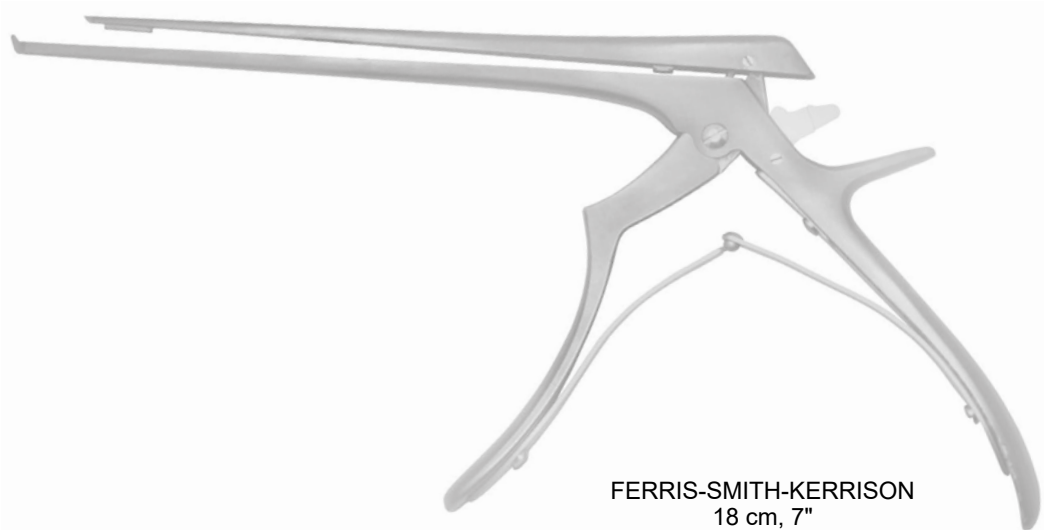

FERRIS-SMITH-KERRISON
 18 cm, 7"

90°



130°



18 cm, 7"	41540-01	1 mm	41542-01	1 mm
20 cm, 8"	41544-01	1 mm	41543-01	1 mm
23 cm, 9"	41544-01-23	1 mm	41543-01-23	1 mm
18 cm, 7"	41540-02	2 mm	41542-02	2 mm
20 cm, 8"	41544-02	2 mm	41543-02	2 mm
23 cm, 9"	41544-02-23	2 mm	41543-02-23	2 mm
18 cm, 7"	41540-03	3 mm	41542-03	3 mm
20 cm, 8"	41544-03	3 mm	41543-03	3 mm
23 cm, 9"	41544-03-23	3 mm	41543-03-23	3 mm
18 cm, 7"	41540-04	4 mm	41542-04	4 mm
20 cm, 8"	41544-04	4 mm	41543-04	4 mm
23 cm, 9"	41544-04-23	4 mm	41543-04-23	4 mm
18 cm, 7"	41540-05	5 mm	41542-05	5 mm
20 cm, 8"	41544-05	5 mm	41543-05	5 mm
23 cm, 9"	41544-05-23	5 mm	41543-05-23	5 mm

auch lieferbar mit Dünnfuß und/oder mit Auswerfer
 also available with thin foot plate and/or with ejector
 tambien disponible con lámina de punzonar estrecha y/o con expulsor
 anche disponibile con morso sottile e/o con espulsore

Bandscheibenstanzen, zerlegbar
 Intervertebral Disc Rongeurs, dismountable
 Pinzas sacabocado para discos intervertebrales, desmontable
 Pinze taglienti per dischi intervertebrali, smontabile a fucile

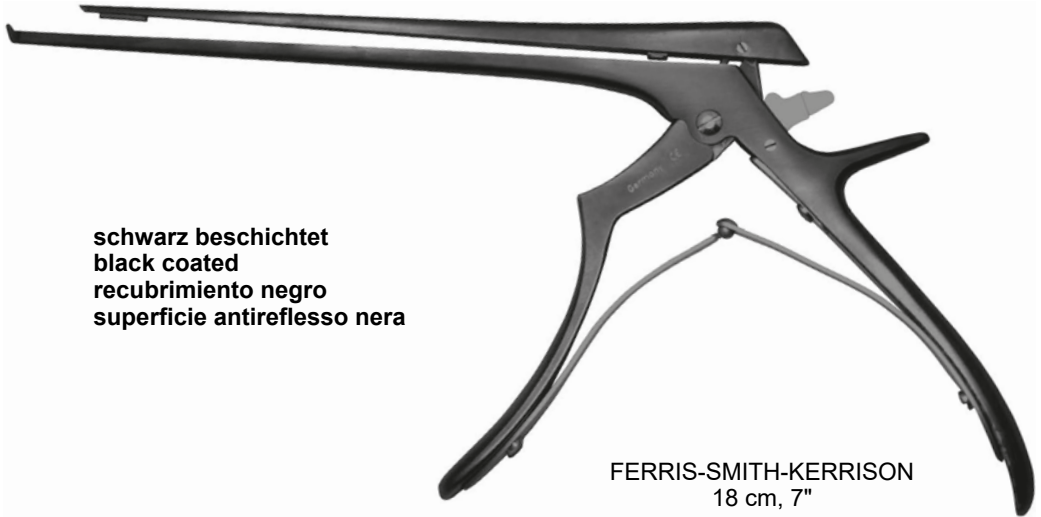

schwarz beschichtet
black coated
recubrimiento negro
superficie antireflesso nera

FERRIS-SMITH-KERRISON
 18 cm, 7"

90°

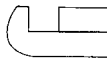

130°



18 cm, 7"	41540-01B	1 mm	41542-01B	1 mm
20 cm, 8"	41544-01B	1 mm	41543-01B	1 mm
23 cm, 9"	41544-01-23B	1 mm	41543-01-23B	1 mm
18 cm, 7"	41540-02B	2 mm	41542-02B	2 mm
20 cm, 8"	41544-02B	2 mm	41543-02B	2 mm
23 cm, 9"	41544-02-23B	2 mm	41543-02-23B	2 mm
18 cm, 7"	41540-03B	3 mm	41542-03B	3 mm
20 cm, 8"	41544-03B	3 mm	41543-03B	3 mm
23 cm, 9"	41544-03-23B	3 mm	41543-03-23B	3 mm
18 cm, 7"	41540-04B	4 mm	41542-04B	4 mm
20 cm, 8"	41544-04B	4 mm	41543-04B	4 mm
23 cm, 9"	41544-04-23B	4 mm	41543-04-23B	4 mm
18 cm, 7"	41540-05B	5 mm	41542-05B	5 mm
20 cm, 8"	41544-05B	5 mm	41543-05B	5 mm
23 cm, 9"	41544-05-23B	5 mm	41543-05-23B	5 mm

auch lieferbar mit Dünnfuß und/oder mit Auswerfer
 also available with thin foot plate and/or with ejector
 tambien disponible con lámina de punzonar estrecha y/o con expulsor
 anche disponibile con morso sottile e/o con espulsore

Bandscheibenstanzen
 Intervertebral Disc Rongeurs
 Pinzas sacabocado para discos intervertebrales
 Pinze taglianti per dischi intervertebrali

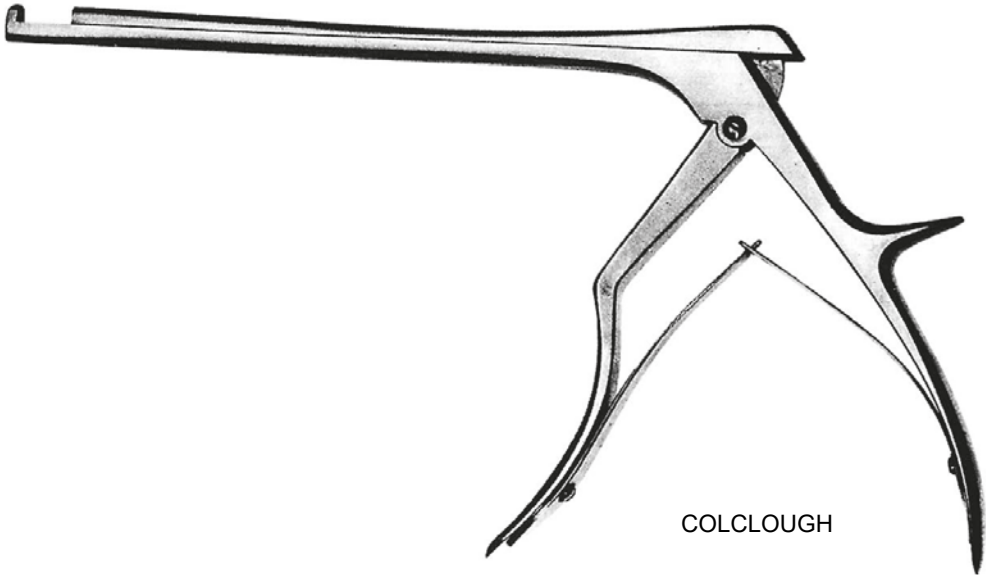

COLCLOUGH

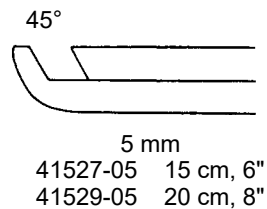
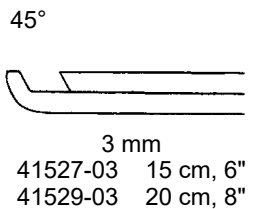
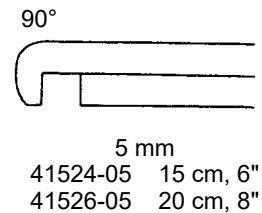
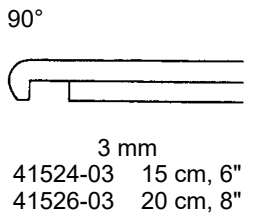
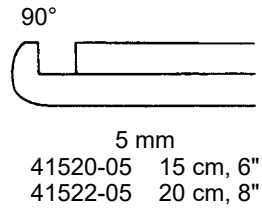
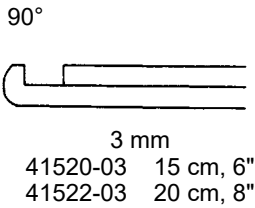

Stanzen
Punches
Pinzas
Pinze-Punzoni



KERRISON
17 cm, 6³/₄"
3x3 mm 47303-03
4x4 mm 47303-04
5x5 mm 47303-05
6x6 mm 47303-06

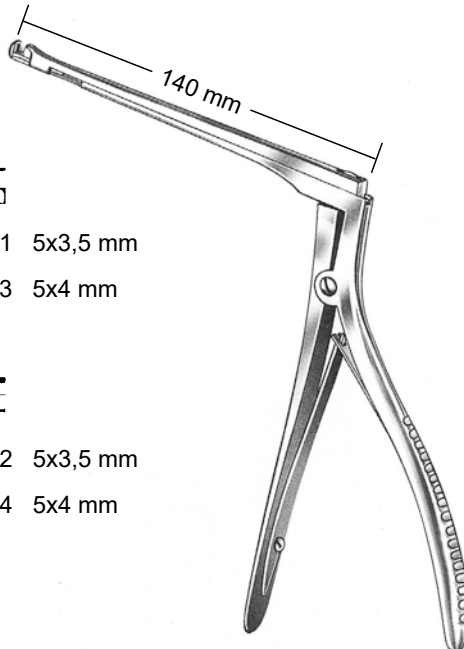

⌒ 47304-01 5x3,5 mm

⌒ 47304-03 5x4 mm



⌒ 47304-02 5x3,5 mm

⌒ 47304-04 5x4 mm

HAJEK-KOFLER
47304-01 - 47304-04

Stanzen
Punches
Pinzas
Pinze-Punzoni



CITELLI
47311-10 1,0 mm
47311-25 2,5 mm
47311-30 3,0 mm

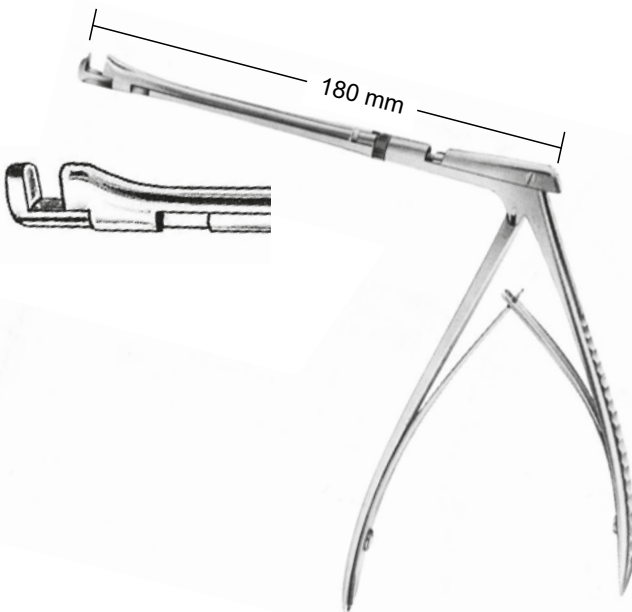

HAJEK-KOFLER
47316-16
3,5 mm

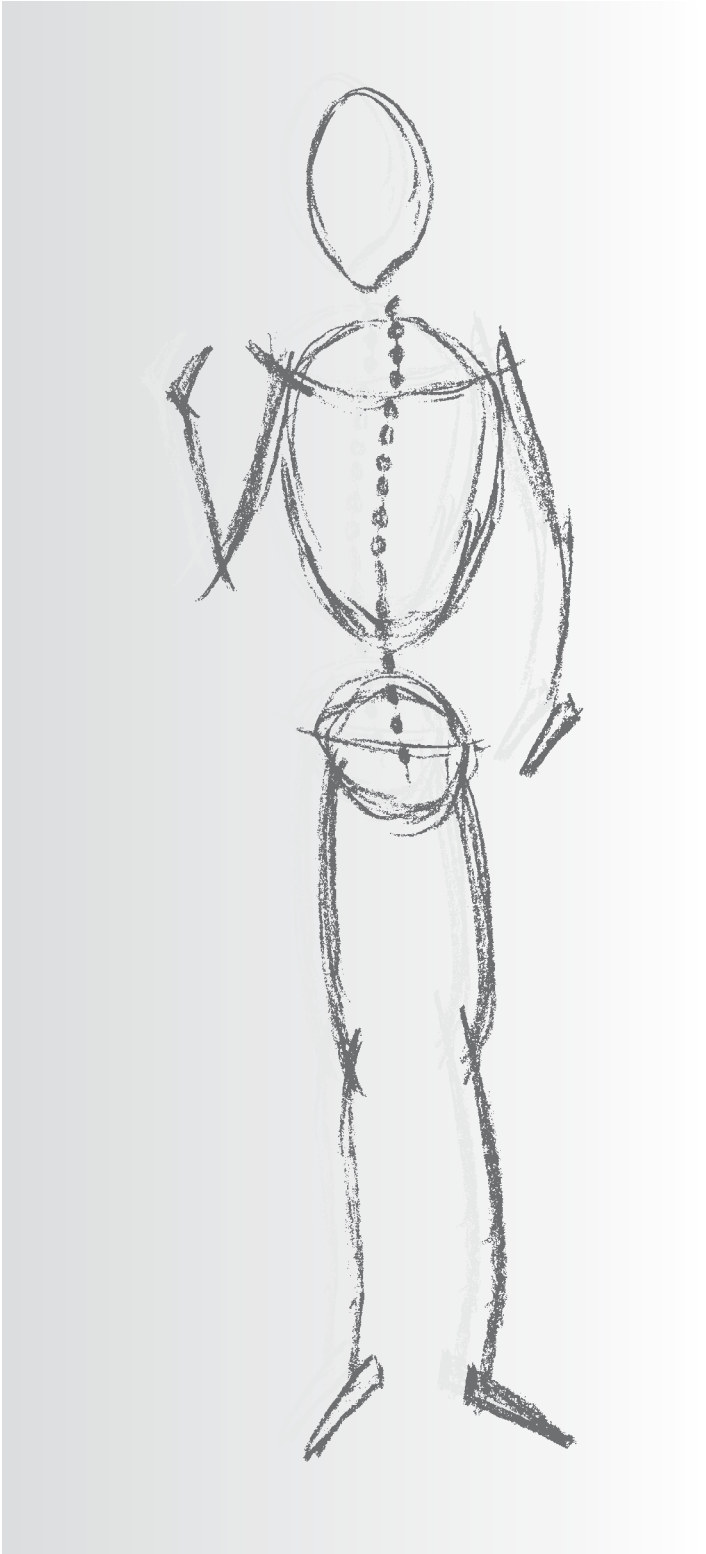

Reda Instrumente GmbH
Gänsäcker 34 - P.O. Box 131
D-78532 Tuttlingen

BOHRAPPARATE

BONE HAND DRILLS

PERFORADORES DE MANO

PERFORATORI A MANO

Bohrapparate
Bone Hand Drills
Perforadores de mano
Perforatori a mano



34241-00
Griff allein
Handle only
Mango solo
Manico solo

HUDSON
34240-27
27 cm, 10½"
compl. incl.
34242-09, -14, -16, -22,
34246-00



34242-09
9 mm



34242-14
14 mm



34242-16
16 mm



34242-22
22 mm



34246-00

Verlängerungsstück
Extension piece
Pieza alargadera
Giunto di prolungamento



Ø 2 mm
34243-02



CUSHING
34244-10
34244-14
34244-16



ERRICO
34244-17
Ø 16 mm



MC KENZIE
34248-00
Ø 13 mm

Bohrapparate
Bone Hand Drills
Perforadores de mano
Perforatori a mano

Bohrapparat 16 cm (6 ¼"), längsdurchbohrt mit Drei-
backenspannfutter und Schlüssel, Spannweite bis 4 mm

Hand drill, 16 cm (6 ¼"), longitudinally bored, with three-
jaw-chuck and key, opening up to 4 mm

Perforador manual, 16 cm (6 ¼"), taladrado
longitudinalmente, con mandril de tres mordazas y
llave, apertura hasta 4 mm

Perforatore a mano, 16 cm (6 ¼"), con perforazione
assiale, con mandrino a tre ganasce e chiave, apertura
fino a 4 mm di D.

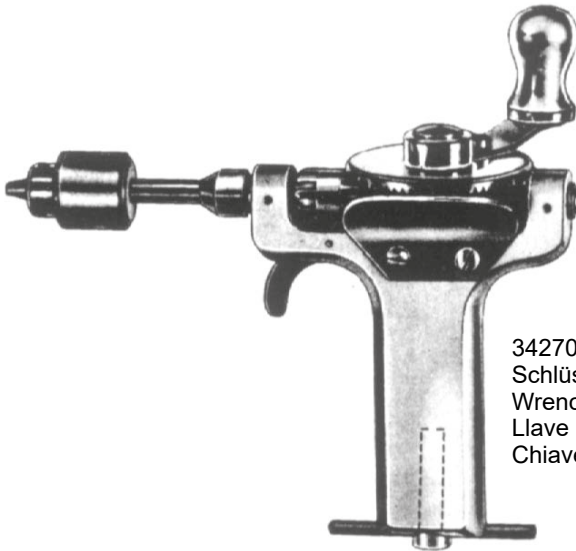

34270-01
Schlüssel
Wrench
Llave
Chiave

BUNELL
34270-00
16 cm, 6¼"

Bohrapparate
Bone Hand Drills
Perforadores de mano
Perforatori a mano



RALK
34280-00

Bohrapparat mit Leichtmetallgehäuse,
mit Dreibackenspannfutter und
Schlüssel, Spannweite bis D. 6,35 mm

Hand drill with light metal case, with
three-jaw-chuck and key, opening up to
D. 6,35 mm

Perforador manual con caja de metal
ligero, con mandril de tres mordazas y
llave, apertura hasta Ø 6,35 mm

Perforatore a mano con cassa in metallo
leggero, con mandrino a tre ganasce e
chiave, apertura fino a 6,35 mm di D.



REDA
34290-00

Handbohrapparat mit umstellbarem
Handgriff, mit Jacobs Dreibackenspann-
futter und Schlüssel

Hand drill with adjustable handle, with
Jacobs three-jaw-chuck and wrench

Perforador manual con mango ajustable,
con mandril Jacobs de 3 mordazas y
llave

Perforatore a mano con manico regola-
bile, con mandrino Jacobs a tre ganasce
complete con chiave



34295-00
Spannschlüssel allein
Key only
Llave sola
Chiave solo

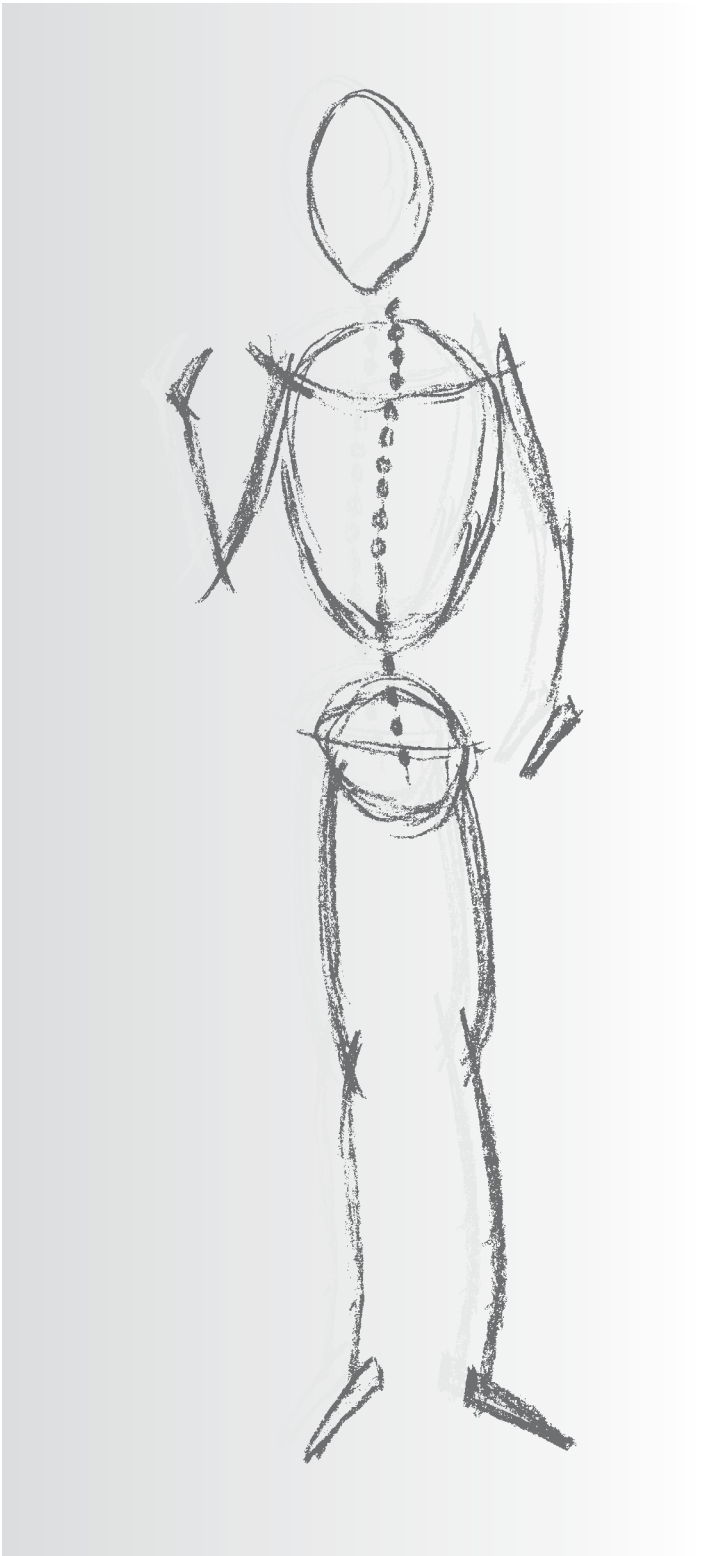

Reda Instrumente GmbH
Gänsäcker 34 - P.O. Box 131
D-78532 Tuttlingen

BIPOLARE KOAGULATION

BIPOLAR COAGULATION

COAGULACIÓN BIPOLAR

COAGULAZIONE BIPOLARE

Bipolare Koagulation
Bipolar Coagulation
Coagulación bipolar
Coagulazione bipolare



91104-11
11 cm, 4³/₈"
0,5 mm



91109-11
11 cm, 4³/₈"
45°, 0,5 mm



91113-11
11 cm, 4³/₈"
45°, 0,5 mm



91122-16
16,5 cm, 6¹/₂"
0,5 mm



91123-16
16,5 cm, 6¹/₂"
0,5 mm



91125-16
16,5 cm, 6¹/₂"
0,5 mm

Bipolare Koagulation
Bipolar Coagulation
Coagulación bipolar
Coagulazione bipolare



91142-16
16 cm, 6¼"
0,3 mm



91144-16
16,5 cm, 6½"
0,5 mm



91146-16
16,5 cm, 6½"
1 mm



91152-19
19,5 cm, 7¾"
0,3 mm



91154-19
19,5 cm, 7¾"
1 mm



91157-19
19,5 cm, 7¾"
1 mm



91159-19
19,5 cm, 7¾"
2 mm



Bipolare Koagulation
Bipolar Coagulation
Coagulación bipolar
Coagulazione bipolare



91162-19
19,5 cm, 7³/₄"
0,3 mm



19,5 cm, 7³/₄"
91163-19 0,5 mm
91164-19 1,0 mm

Bipolare Koagulation
Bipolar Coagulation
Coagulación bipolar
Coagulazione bipolare



91166-19
19,5 cm, 7 $\frac{3}{4}$ "
2 mm



91172-03
0,3 mm

91172-07
0,7 mm

91172-12
1,2 mm

91172-03 - 91172-12
22,5 cm, 8.9"

Bipolare Koagulation
 Bipolar Coagulation
 Coagulación bipolar
 Coagulazione bipolare

NON STICK

gerade
 straight
 recta
 retta



	0,3 mm	0,5 mm	1,0 mm	2,0 mm
11,0 cm, 4 ³ / ₈ "	91110-03N	91110-05N	91110-10N	
16,0 cm, 6 ¹ / ₄ "	91160-03N	91160-05N	91160-10N	91160-20N
18,0 cm, 7"		91180-05N	91180-10N	91180-20N
19,5 cm, 7 ³ / ₄ "		91200-05N	91200-10N	91200-20N
22,0 cm, 8 ³ / ₄ "			91220-10N	91220-20N
24,0 cm, 9 ¹ / ₂ "			91240-10N	
30,0 cm, 12"			91300-10N	91300-20N

abgewinkelt 45°
 angled 45°
 angulada 45°
 angolata 45°



	0,3 mm	0,5 mm	1,0 mm	2,0 mm
11,0 cm, 4 ³ / ₈ "	91112-03N	91112-05N	91112-10N	
16,0 cm, 6 ¹ / ₄ "		91162-05N	91162-10N	
18,0 cm, 7"			91182-10N	91182-20N
19,5 cm, 7 ³ / ₄ "		91202-05N	91202-10N	91202-20N
22,0 cm, 8 ³ / ₄ "			91222-10N	91222-20N
24,0 cm, 9 ¹ / ₂ "			91242-10N	
30,0 cm, 12"			91302-10N	

NON STICK

Bipolare Koagulation
Bipolar Coagulation
Coagulación bipolar
Coagulazione bipolare

bayonett gerade
bajonett straight
bayoneta recta
baionetta retta



	0,3 mm	0,5 mm	1,0 mm	2,0 mm
16,0 cm, 6¼"	91166-03N	91166-05N	91166-10N	91166-20N
19,5 cm, 7¾"		91206-05N	91206-10N	91206-20N
22,0 cm, 8¾"		91226-05N	91226-10N	91226-20N
24,0 cm, 9½"		91246-05N	91246-10N	91246-20N

bayonett nach oben
bajonett upwards
bayoneta hacia arriba
baionetta in alto



	1,0 mm
19,5 cm, 7¾"	91207-10N
22,0 cm, 8¾"	91227-10N

bayonett nach unten
bajonett downwards
bayoneta hacia abajo
baionetta in basso



	0,5 mm	1,0 mm
16,0 cm, 6¼"	91168-05N	91168-10N
19,5 cm, 7¾"		91208-10N
22,0 cm, 8¾"		91228-10N

Bipolare Saugpinzetten
Bipolar suction Forceps
Pinza de succión bipolar
Pinza bipolare con canale di aspirazione

Saugpinzetten zum Absaugen von Blut und Sekret vor der Koagulation bzw. zum Absaugen von Rauch während der Koagulation.

Europäischer Flachstecker zum Anschluß von bipolaren Kabeln für praktisch alle gebräuchlichen HF-Generatoren.

Der Saugkanal mit Unterbrecherloch ist in einem Schenkel der Pinzette integriert.

An der Schlaucholive können verschiedene Schlauchdurchmesser angeschlossen werden.

Suction forceps for extraction of blood and debris by suction right before coagulation or extraction of smoke while coagulating.

European flat socket connector for bipolare cables for nearly all common high frequency generators. Suction channel embedded inside the forceps.

Suction connector matches different suction tube diameters.



Pinza de succión para sangre y líquidos antes de efectuar la coagulación como también para la eliminación de humo durante la coagulación. Enchufe plano europeo para conectar cables bipolares de equipos de alta frecuencia en uso corrientemente.

El canal de succión con su agujero de interrupción está incorporado en un lado de la pinza.

El diseño de la oliva de conexión permite la adaptación de tubos de varios diámetros.

Pinza bipolare dotata di canale di aspirazione. Per aspirare fumi, sangue ecc. durante la coagulazione. Attacco piatto per cavi bipolari con attacchi europei.

Il canale di aspirazione con interruzione é integrato sulla aletta della pinza.





Ingresso del canale di aspirazione ad oliva che permette attacchi di diversi diametri.

Bipolare Verbindungskabel
 Bipolar connecting cables
 Cables de conexión bipolares
 Cavi di collegamento bipolari

Bipolar

Geräte seite
 Unit / Equipment side
 Lado de la unidad/equipamiento
 Unità / Lato equipaggiamento

Instrumentenseite
 Instrument side
 Lado de los instrumentos
 Lato strumento

	Kabellänge Meter Cable length Meter Longitud del cable Midor Misuratore della lunghezza del cavo	Europa-Flachstecker Europe flat plug El enchufe plano de Europa Spina piatta Europa
Erbe / Storz 12,5 mm Ø 	3	R065-040125-003
	5	R065-040125-005
Martin / Berchtold 8 mm Ø AESCULAP Wolf 	3	R065-020080-003
	5	R065-020080-005
Valleylab / Lamidey / EMC 	3	R065-040285-003
	5	R065-040285-005
2-Pin U.S. Standard Eschmann 	3	R065-040000-003
	5	R065-040000-005

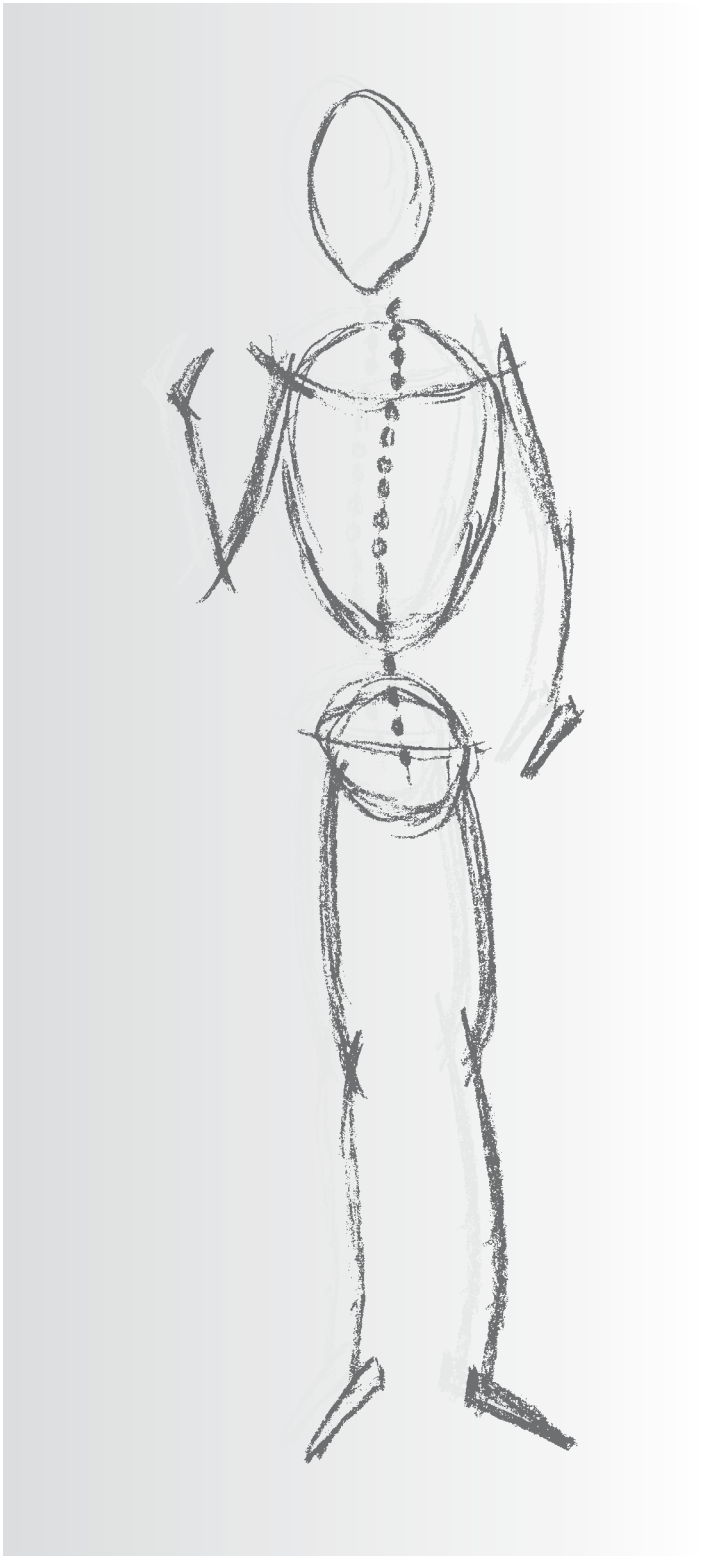

Reda Instrumente GmbH
Gänsäcker 34 - P.O. Box 131
D-78532 Tuttlingen

CLIPS

CLIPS

CLIPS

CLIPS PER ANEURISMA

ACLAND Mikro-Gefäßclips
 ACLAND Micro Vessel Clips
 ACLAND Micro Clips vasculares
 ACLAND Micro Clips vascolari

	Klemmen Nr. 1 Clamp No. 1 Pinza No.1 Morsetto n.1	Klemmen Nr. 2 Clamp No. 2 Pinza No.2 Morsetto n.2	Klemmen Nr. 3 Clamp No. 3 Pinza No.3 Morsetto n.3	Klemmen Nr. 4 Clamp No. 4 Pinza No.4 Morsetto n.4	Klemmen Nr. 5 Clamp No. 5 Pinza No.5 Morsetto n.5
Länge / Length Longitud / Lunghezza	8 mm	11 mm	16 mm	24 mm	35 mm
Gefäß-Ø / Vessel Ø Recipiente Ø / Della nave Ø	0,3 - 1,0 mm	0,6 - 1,4 mm	1,0 - 2,2 mm	1,5 - 3,3 mm	2,0 - 5,0 mm
Einzelklemmen Single Clamps Single clamp Pinza singola					
	41710-08 A 41711-08 V	41710-11 A 41711-11 V	41710-17 A 41711-17 V	41718-25 A 41719-25 V	41718-36 A 41719-36 V
Approximator ohne Rahmen Approximator without frame Aproximador sin marco Apressimatore senza telaio					
	41712-08 A 41713-08 V	41712-11 A 41713-11 V	41712-17 A 41713-17 V	41720-25 A 41721-25 V	41720-36 A 41721-36 V
Doppelklemme mit Rahmen Double Clamps with Frame Clamp doble con marco Pinza doppia con telaio					
	41714-08 A 41715-08 V	41714-11 A 41715-11 V	41714-17 A 41715-17 V		
Approximator mit Rahmen Approximator with frame Aproximador con marco Apressimatore con telaio				A = Arterie/Artery CURVED JAW 	
	41716-08 A 41717-08 V	41716-11 A 41717-11 V	41716-17 A 41717-17 V		
Approximator mit Rahmen Approximator with frame Aproximador con marco Apressimatore con telaio				V = Vene/Vein STRAIGHT JAW 	
	41719-08 A 41721-08 V	41719-11 A 41721-11 V	41719-17 A 41721-17 V		

Clip-Anlegepinzetten für ACLAND-Clips
Clip Applying Forceps for ACLAND clips
Pinzas aplicadora para clips ACLAND
Pinze per applicare clips di ACLAND

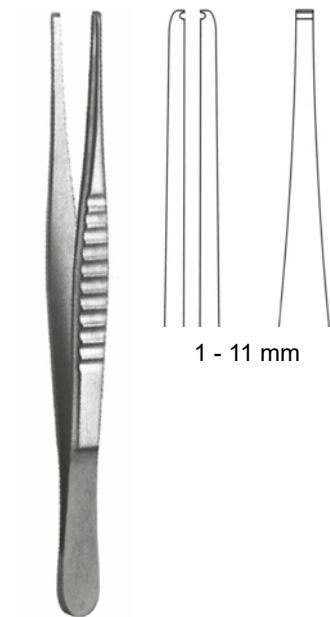

ACLAND
41730-15
14,5 cm, 5 $\frac{3}{4}$ "

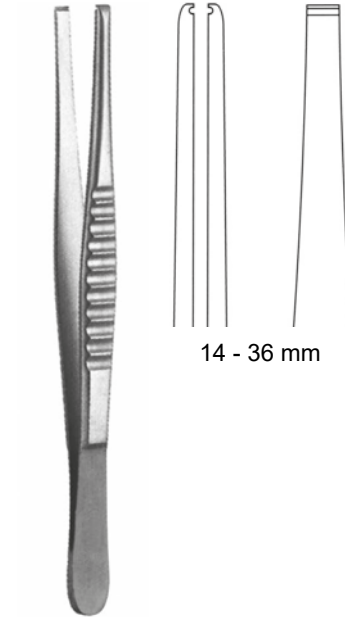

ACLAND
41731-15
14,5 cm, 5 $\frac{3}{4}$ "

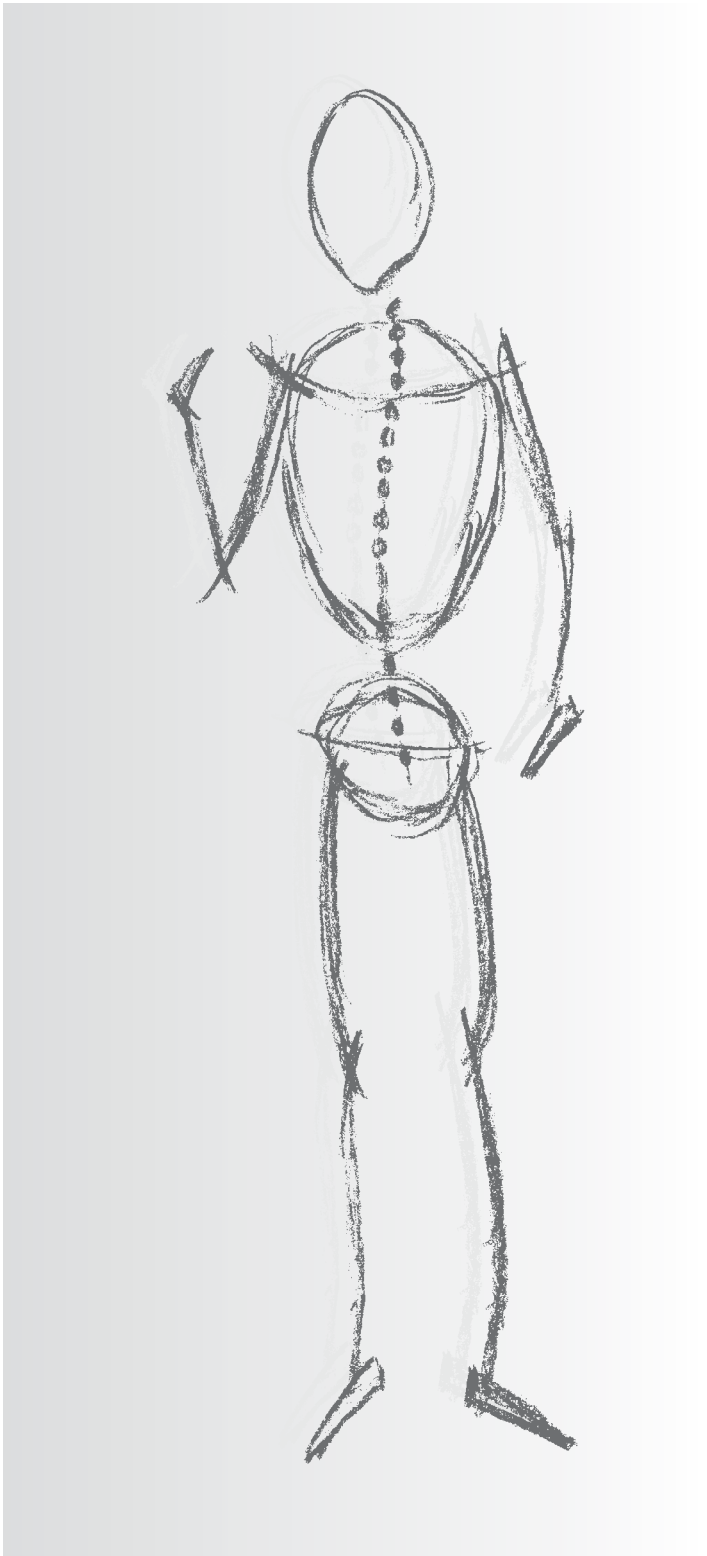

Reda Instrumente GmbH
Gänsäcker 34 - P.O. Box 131
D-78532 Tuttlingen

SÄTZE

SET

SET

SET

Set / 200 Basic Set for Neurosurgery - Neurochirurgie Set

1x	07103-00	scalpel handle no. 3
1x	07107-00	scalpel handle no. 7
1x	07104-00	scalpel handle no. 4
1x	09160-17	MAYO, dissecting scissors, str., 17cm
1x	09161-17	MAYO, dissecting scissors, cvd., 17cm
1x	09280-18	METZENBAUM, dissecting scissors, str., 18cm
1x	11112-18	POTTS-SMITH, dressing forceps, 18cm
1x	11126-18	POTTS-SMITH, tissue forceps, 1x2 teeth, 18cm
1x	11189-15	BROWN, tissue forceps, 9x9 teeth, 15cm
1x	11315-01	TAYLOR, dressing forceps, bayonet, 17cm
1x	11315-02	TAYLOR, tissue forceps, 1x2 teeth, bayonet, 17cm
1x	41295-10	FRAZIER/FERGUSSON, suction tube, 30°, 19cm
2x	25214-18	DeBAKEY, needle holder TC, 18cm
2x	25225-18	RYDER, needle holder TC, 18cm
10x	13220-12	HALSTED-MOSQUITO, hemostatic forceps, str., 12,5cm
6x	13345-14	DANDY, hemostatic forceps, cvd., 14cm
6x	13320-14	ROCHESTER-OCHSNER, hemostatic forceps, 1x2 teeth, str., 14cm
10x	15111-09	BACKHAUS, towel forceps, 9cm
2x	17170-18	FOERSTER, swab forceps, str., 18cm
1x	19214-13	FRAZIER, nerve hooklet, 13cm
1x	19168-06	RIBBON, retractor, 6x200mm
1x	19168-12	RIBBON, retractor, 12x200mm
1x	19168-17	RIBBON, retractor, 17x200mm
1x	19168-25	RIBBON, retractor, 25x200mm
2x	19670-16	WEITLANER, retractor, 16,5cm
2x	19684-16	ADSON-BABY, retractor, 16cm
1x	33711-20	LANGENBECK, periosteal elevator, 20cm
1x	33142-20	ADSON, bone rongeur, str., 20cm
1x	33247-23	LEKSELL-STILLE, bone rongeur, 23cm / 4mm
1x	33245-23	LEKSELL-STILLE, bone rongeur, 23cm / 7mm
6x	65120-15	ALLIS, tissue forceps, 5x6 teeth, 15cm
1x	41512-02	FERRIS-SMITH-KERRISON, rongeur, 45° up, 2mm, 18cm
1x	41512-03	FERRIS-SMITH-KERRISON, rongeur, 45° up, 3mm, 18cm
1x	41512-04	FERRIS-SMITH-KERRISON, rongeur, 45° up, 4mm, 18cm
1x	41432-01	LOVE-GRUENWALD, laminectomy rongeur, str., 3x10mm, 18cm
1x	41432-02	LOVE-GRUENWALD, laminectomy rongeur, 45° up, 3x10mm, 18cm
1x	41432-03	LOVE-GRUENWALD, laminectomy rongeur, 45° down, 3x10mm, 18cm
1x	41254-13	DAVIS, brain spatula, 13mm, 18cm
1x	41161-01	PENFIELD, dura dissector, 17,5cm
1x	41161-02	PENFIELD, dura dissector, 19,5cm
1x	41161-03	PENFIELD, dura dissector, 19,5cm
1x	41161-04	PENFIELD, dura dissector, 21,5cm
1x	41298-12	FRAZIER, canula, 3mm, 12cm
1x	41052-20	DANDY, nerve hook, str., 20cm
1x	19235-21	CUSHING, retractor, 21,5cm
1x	34231-15	ADSON, forceps, 15cm
2x	41094-00	GIGLI, handle for wire saw
5x	41092-50	OLIVECRONA, wire saw, 50cm
1x	41090-33	DE MARTEL, saw conductor, 33cm

Set / 201 Craniotomy Set - Kraniotomie Set

1x	07103-00	scalpel handle no. 3
1x	07107-00	scalpel handle no. 7
1x	07104-00	scalpel handle no. 4
1x	09140-14	DEAVER, dissecting scissors, str., 14,5cm
1x	09160-17	MAYO, dissecting scissors, str., 17cm
1x	09161-17	MAYO, dissecting scissors, cvd., 17cm
1x	09281-18	METZENBAUM, dissecting scissors, cvd., 18cm
2x	11170-12	ADSON, dressing forceps, 12cm
2x	11180-12	ADSON, tissue forceps, 1x2 teeth, 12cm
1x	11220-17	CUSHING, dressing forceps, str., 17cm
1x	11222-17	CUSHING, tissue forceps, str., 1x2 teeth, 17cm
1x	11315-01	TAYLOR, dressing forceps, bayonet, 17cm
1x	11315-02	TAYLOR, tissue forceps, 1x2 teeth, bayonet, 17cm
2x	41295-08	FRAZIER/FERGUSON, suction tube, 30°, Charr. 8, 19cm
10x	13220-12	HALSTED-MOSQUITO, hemostatic forceps, str., 12,5cm
10x	13221-12	HALSTED-MOSQUITO, hemostatic forceps, cvd., 12cm
10x	13345-14	DANDY, hemostatic forceps, cvd., 14cm
10x	15111-13	BACKHAUS, towel forceps, 13cm
5x	17170-25	FOERSTER, swab forceps, str., 25cm
2x	19235-21	CUSHING, retractor, 21,5cm
2x	19214-13	FRAZIER, nerve hooklet, 13cm
1x	19630-10	JANSEN, retractor, 10cm
2x	19670-20	WEITLANER, retractor, 20cm
1x	33483-00	BRUNS, bone curette, Fig.0, str., 23cm
1x	33483-01	BRUNS, bone curette, Fig.1, str., 23cm
1x	33483-02	BRUNS, bone curette, Fig.2, str., 23cm
1x	33483-03	BRUNS, bone curette, Fig.3, str., 23cm
1x	33137-17	LUER, bone rongeur, cvd., 17cm
1x	33151-16	LEMPERT, bone rongeur, cvd., 16cm
1x	33230-22	STILLE-LUER, bone rongeur, str., 22cm
1x	33231-22	STILLE-LUER, bone rongeur, cvd., 22cm
1x	41096-21	DeVILBIS, skull punch, 21cm
1x	41432-01	LOVE-GRUENWALD, laminectomy rongeur, str., 3x10mm, 18cm
1x	41432-02	LOVE-GRUENWALD, laminectomy rongeur, 45° up, 3x10mm, 18cm
1x	41432-03	LOVE-GRUENWALD, laminectomy rongeur, 45° down, 3x10mm, 18cm
1x	09619-17	SCHMIEDEN-TAYLOR, dura scissors, 17cm
1x	41254-13	DAVIS, brain spatula, 13mm, 18cm
1x	41250-11	CUSHING, brain spatula, 8x10mm
1x	41253-11	OLIVECRONA, brain spatula, 11mm/13mm
1x	41158-01	FRAZIER, dura dissector, 15cm
2x	41298-12	FRAZIER, canula 3mm/12cm
1x	41052-20	DANDY, nerve hook, str., 20cm
1x	19234-20	CUSHING, retractor, 20cm
1x	34240-27	HUDSON, bone hand drill, 27cm
1x	34231-15	ADSON, forceps, 15cm
2x	41094-00	GIGLI, handle for wire saw
10x	41092-50	OLIVECRONA, wire saw, 50cm
2x	41090-33	DeMARTEL, saw conductor, 33cm
1x	41028-00	RANEY, applying forceps
1x	91162-19	bipolar forceps, 0,3mm, 19,5cm
1x	91193-30	bipolar connecting cable, 3 meter

Set / 202 Laminectomy Set - Laminektomie Set

1x	07103-00	scalpel handle no. 3
1x	07104-00	scalpel handle no. 4
1x	09140-14	DEAVER, dissecting scissors, str., 14,5cm
1x	09160-17	MAYO, dissecting scissors, str., 17cm
1x	09161-17	MAYO, dissecting scissors, cvd., 17cm
1x	09281-18	METZENBAUM, dissecting scissors, cvd., 18cm
2x	11102-14	dressing forceps, 14,5cm
1x	11102-20	dressing forceps, 20cm
2x	11120-14	tissue forceps, 1x2 teeth, 14,5cm
1x	11120-20	tissue forceps, 1x2 teeth, 20cm
1x	11220-17	CUSHING, dressing forceps, str., 17cm
1x	11222-17	CUSHING, tissue forceps, str., 1x2 teeth, 17cm
1x	11315-01	TAYLOR, dressing forceps, bayonet, 17cm
1x	11315-02	TAYLOR, tissue forceps, 1x2 teeth, bayonet, 17cm
1x	41295-08	FRAZIER/FERGUSSON, suction tube, 30°, Charr.8, 19cm
1x	41295-10	FRAZIER/FERGUSSON, suction tube, 30°, Charr. 10, 19cm
1x	41295-12	FRAZIER/FERGUSSON, suction tube, 30°, Charr. 12, 19cm
2x	25180-16	MAYO-HEGAR, needle holder, 16cm
10x	13220-12	HALSTED-MOSQUITO, hemostatic forceps, str., 12,5cm
10x	13221-12	HALSTED-MOSQUITO, hemostatic forceps, cvd., 12cm
6x	13263-16	CRILE-RANKIN, hemostatic forceps, cvd., 16cm
6x	13265-16	CRILE-RANKIN, hemostatic forceps, 1x2 teeth, cvd., 16cm
5x	17170-25	FOERSTER, swab forceps, str., 25cm
2x	19235-21	CUSHING, retractor, 21,5cm
2x	19281-04	VOLKMANN, retractor, 4 teeth, 21,5cm
2x	19670-20	WEITLANER, retractor, sharp, 20cm
1x	19686-32	ADSON, retractor, blunt, 32cm
1x	19690-31	BECKMANN, retractor, sharp, 31cm
1x	33711-20	LANGENBECK, elevator, 8mm, 20cm
1x	33710-19	LANGENBECK, elevator, 16mm, 19cm
1x	33700-03	BERGMANN, hammer, Ø 45mm, 300 gr., 24cm
1x	33482-98	BRUNS, bone curette, Fig.00, str., 23cm
1x	33483-00	BRUNS, bone curette, Fig.0, str., 23cm
1x	33483-01	BRUNS, bone curette, Fig.1, str., 23cm
1x	33483-02	BRUNS, bone curette, Fig.2, str., 23cm
1x	33483-03	BRUNS, bone curette, Fig.3, str., 23cm
1x	33483-04	BRUNS, bone curette, Fig.4, str., 23cm
1x	33483-05	BRUNS, bone curette, Fig.5, str., 23cm
1x	33483-06	BRUNS, bone curette, Fig.6, str., 23cm
1x	33136-17	LUER, bone rongeur, str., 17cm
1x	33231-22	STILLE-LUER, bone rongeur, cvd., 22cm
1x	33235-23	STILLE-LUER, bone rongeur, 23cm
1x	33293-27	STILLE-HORSLEY, bone cutting forceps, 27cm
1x	33290-27	STILLE-LISTON, bone cutting forceps, 27cm
5x	65120-15	ALLIS, tissue forceps, 5x6 teeth, 15cm
1x	41512-02	FERRIS-SMITH-KERRISON, 45° up, 2mm, 18cm
1x	41512-03	FERRIS-SMITH-KERRISON, 45° up, 3mm, 18cm
1x	41512-04	FERRIS-SMITH-KERRISON, 45° up, 4mm, 18cm
1x	41432-01	LOVE-GRUENWALD, laminectomy rongeur, str., 3x10mm, 18cm
1x	41432-02	LOVE-GRUENWALD, laminectomy rongeur, 45° up, 3x10mm, 18cm
1x	41432-03	LOVE-GRUENWALD, laminectomy rongeur, 45° down, 3x10mm, 18cm

1x	41151-24	DAVIS, dura dissector, 24cm
1x	47415-18	FREER, septum elevator, 18cm
1x	41161-00	PENFIELD, dura dissector, 17,5cm
1x	41161-02	PENFIELD, dura dissector, 19,5cm
1x	41161-03	PENFIELD, dura dissector, 19,5cm
1x	41161-04	PENFIELD, dura dissector, 21,5cm
1x	41052-20	DANDY, nerve hook, str., 20cm
1x	41056-18	CUSHING, nerve hook, 18cm
1x	41074-23	SCOVILLE, retractor, str., 23cm
1x	19911-00	SCOVILLE, frame only, 15cm
1x	19912-50	SCOVILLE, hook only, 50mm
1x	19917-64	SCOVILLE, blade only, 64x25mm
1x	41020-00	clip carrier with 1 holder
1x	41019-14	OLIVECRONA-TOENNIS, 140mm
1x	91162-19	bipolar forceps, 0,3mm, 19,5cm
1x	91193-30	bipolar connecting cable, 3 meter

Set / 203 Skull Traction Set - Schädel Traktion Set

1x	07103-00	scalpel handle no. 3
1x	09160-14	MAYO, dissecting scissors, str., 14,5cm
1x	11120-14	tissue forceps, 1x2 teeth, 14,5cm
1x	13220-12	HALSTED-MOSQUITO, hemostatic forceps, str., 12,5cm
1x	13221-12	HALSTED-MOSQUITO, hemostatic forceps, cvd., 12cm
2x	17170-25	FOERSTER, swab forceps, str., 25cm
1x	41025-02	CRUTCHFIELD, traction long
1x	34240-27	HUDSON, bone hand drill, complete, 27cm
6x	15111-09	BACKHAUS, towel forceps, 9cm

Set / 204 Transphenoidal Hypophysectomy Set - Transphenoidal Hypophysektomie Set

2x	07103-00	scalpel handle no. 3
1x	07104-00	scalpel handle no. 4
1x	09120-14	operating scissors, standard, str., 14cm
1x	11110-14	dressing forceps, narrow, 14cm
1x	09375-11	STRABISMUS, scissors TC, cvd., 11cm
1x	11170-12	ADSON, dressing forceps, 12cm
1x	11180-12	ADSON, tissue forceps, 1x2 teeth, 12cm
1x	47154-20	JANSEN, nasal forceps, 20cm
2x	41295-08	FRAZIER/FERGUSSON, suction tube, 30°, Charr. 8, 19cm
2x	41295-10	FRAZIER/FERGUSSON, suction tube, 30°, Charr. 10, 19cm
2x	41295-12	FRAZIER/FERGUSSON, suction tube, 30°, Charr. 12, 19cm
2x	25144-13	HALSEY, needle holder TC, 13cm
2x	13221-12	HALSTED-MOSQUITO, hemostatic forceps, cvd., 12cm
2x	13211-10	HARTMANN, hemostatic forceps, cvd., 10cm
2x	13475-14	MIXTER-BABY, hemostatic forceps, 14cm
2x	19160-17	SENN-MILLER, retractor, 3 teeth, 17cm
6x	15111-13	BACKHAUS, towel forceps, 13cm
2x	17170-25	FOERSTER, swab forceps, str., 25cm
2x	19221-03	nerve and wound hooks, 3 prongs, 16cm
1x	41522-03	COLCLOUGH, disc rongeur, 90° up, 3mm, 20cm
1x	41512-02	FERRIS-SMITH-KERRISON, rongeur, 45° up, 2mm, 18cm
1x	41512-03	FERRIS-SMITH-KERRISON, rongeur, 45° up, 3mm, 18cm
1x	41422-01	CUSHING, laminectomy rongeur, str., 2x10mm, 18cm
1x	41432-01	LOVE-GRUENWALD, laminectomy rongeur, str., 3x10mm, 18cm
1x	41432-02	LOVE-GRUENWALD, laminectomy rongeur, 45° up, 3x10mm, 18cm
1x	41442-01	SPURLING, laminectomy rongeur, str., 4x10mm, 18cm
1x	41254-13	DAVIS, brain spatula, 13mm, 18cm
1x	41447-27	LANDOLT, tumor grasping forceps, Ø 9mm, 27cm
1x	93670-01	HARDY, enucleator, blunt, right, 24,5cm
1x	93670-09	HARDY, implant fork, 24,5cm
1x	93700-06	HARDY, curette, malleable, 6mm, 26cm
1x	93660-01	NICOLA, curette, malleable, 6,5mm, right, 21,5cm
1x	93660-02	NICOLA, curette, malleable, 6,5mm, left, 21,5cm
1x	93660-03	NICOLA, curette, malleable, 6,5mm, 21,5cm
1x	93600-01	CUSHING-LANDOLT, specula, 70x15mm
1x	93600-02	CUSHING-LANDOLT, specula, 90x15mm
1x	93605-21	LANDOLT, spreader for specula, 21cm
1x	93710-03	LANDOLT-REULEN, raspatory, 2,2mm, 26cm
1x	93710-04	LANDOLT-REULEN, raspatory, 3,2mm, 26cm
1x	93710-07	LANDOLT-REULEN, dissector, 2,0mm, 26cm
1x	93720-02	NICOLA, forceps, scoop-shaped, str., 16,5cm
1x	93720-04	NICOLA, grasping forceps, str., 16,5cm
1x	93720-03	NICOLA, micro scissors, str., 16,5cm
1x	93630-04	COTTLE, chisel, 4mm, 18,5cm
1x	33700-05	COTTLE, hammer, Ø 30mm, 240 gr., 18cm

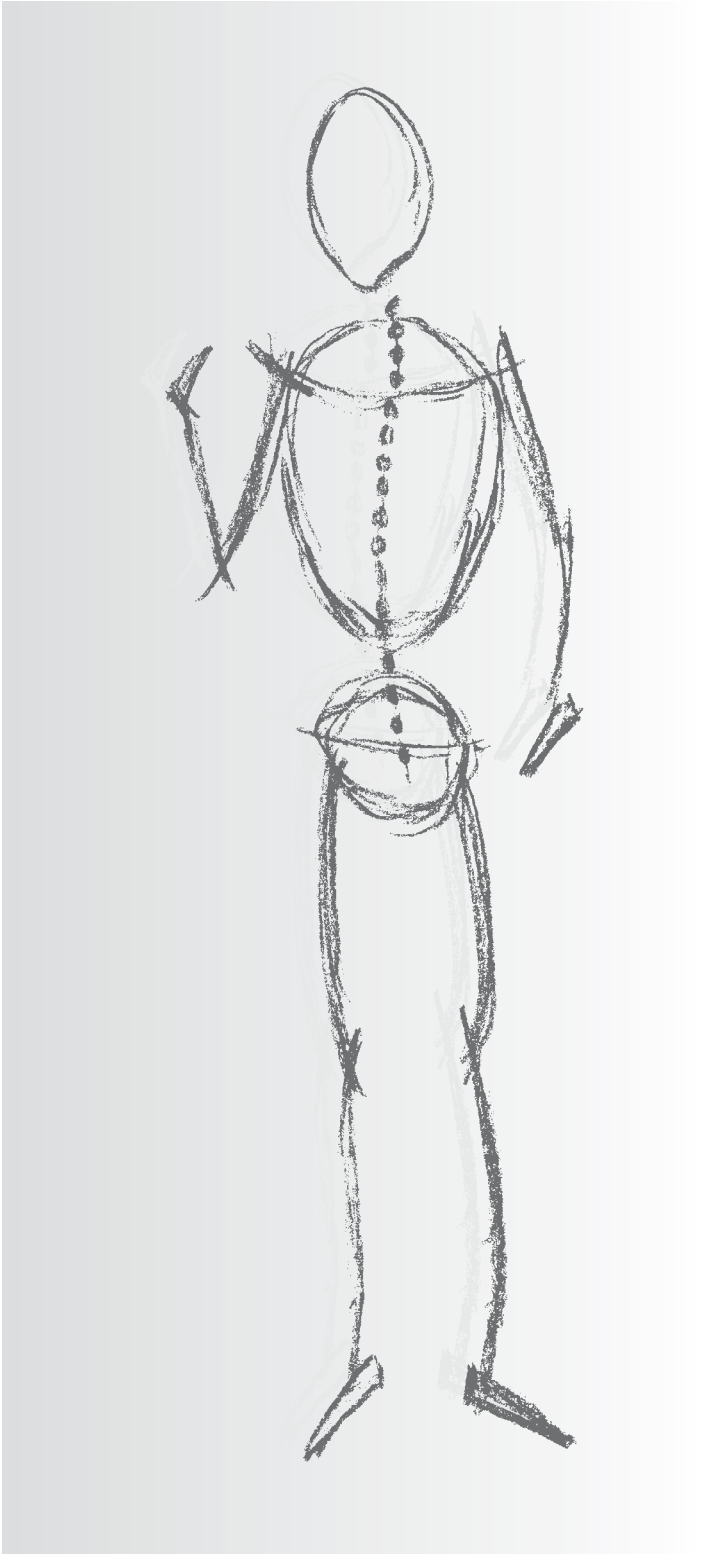

Reda Instrumente GmbH
Gänsäcker 34 - P.O. Box 131
D-78532 Tuttlingen

NUMMERNVERZEICHNIS

NUMERICAL INDEX

INDICE NUMÉRICO

INDICE NUMERICO

33632-08192	33650-08194	33661-15197	33709-0010	33753-01252
33632-10192	33650-10194	33661-20197	33709-0110	33753-02252
33632-12192	33650-13194	33661-25197	33709-0210	33753-03252
33632-15192	33650-16194	33661-30197	33709-21204	33754-17214
33632-20192	33650-18194	33664-04197	33710-01204	33755-17214
33632-25192	33650-20194	33664-06197	33710-02204	33756-17214
33632-30192	33650-25194	33664-08197	33710-07205	33757-17214
33633-06192	33650-30194	33664-10197	33710-15205	33758-04213
33633-08192	33650-38194	33664-12197	33710-19205	33758-06213
33633-10192	33650-44194	33665-04197	33710-20205	33758-08213
33633-12192	33650-50194	33665-06197	33711-16206	33759-06214
33633-15192	33651-04194	33665-08197	33711-18205	33759-12214
33633-20192	33651-06194	33665-10197	33711-20205	33759-19214
33633-25192	33651-08194	33665-12197	33711-21205	33759-25214
33633-30192	33651-10194	33665-24198	33712-16206	33765-17215
33634-06192	33651-13194	33665-26198	33713-16206	33767-19215
33634-08192	33651-16194	33665-55198	33713-17206	33831-16105
33634-10192	33651-18194	33665-90198	33714-15206	33833-16105
33634-12192	33651-20194	33666-22198	33715-20206	33966-1189
33634-15192	33651-25194	33667-06199	33716-18206	
33634-20192	33651-30194	33667-08199	33717-19-01207	
33634-25192	33651-38194	33667-11199	33717-19-02207	
33634-30192	33651-44194	33667-16199	33718-16207	
33644-06193	33651-50194	33669-05199	33719-17207	
33644-09193	33652-02195	33669-10199	33720-19207	
33644-13193	33652-03195	33669-15199	33720-21207	
33644-16193	33652-04195	33670-05199	33721-17208	
33644-19193	33652-06195	33670-10199	33722-06209	
33644-25193	33652-08195	33670-15199	33722-08209	
33644-32193	33652-10195	33691-349	33723-17208	
33645-06193	33652-12195	33694-019	33725-17208	
33645-09193	33652-15195	33694-039	33727-17208	
33645-13193	33654-02195	33695-409	33728-24209	
33645-16193	33654-03195	33699-179	33729-24209	
33645-19193	33654-04195	33700-0110	33731-22210	
33645-25193	33654-06195	33700-01-0110	33733-22210	
33645-32193	33654-08195	33700-0510	33740-19211	
33647-06193	33654-10195	33700-0710	33741-18211	
33647-09193	33654-12195	33701-16202	33742-18211	
33647-14193	33654-15195	33702-15202	33743-18211	
33647-16193	33656-28196	33703-15202	33745-19212	
33647-19193	33657-28196	33704-01202	33746-19212	
33647-25193	33658-28196	33704-02203	33747-18212	
33647-32193	33659-28196	33705-05203	33748-20212	
33649-09193	33660-07197	33705-10203	33749-10213	
33649-14193	33660-10197	33705-15203	33749-13213	
33649-16193	33660-15197	33705-20203	33749-19213	
33649-19193	33660-20197	33705-25203	33750-08213	
33649-25193	33660-25197	33706-18203	33750-17213	
33649-32193	33660-30197	33707-15203	33751-01252	
33650-04194	33661-07197	33707-17204	33751-02252	
33650-06194	33661-10197	33708-19204	33751-03252	

34

34231-15177
34240-27282
34241-00282
34242-09282
34242-14282
34242-16282
34242-22282
34243-02282
34244-10282
34244-14282
34244-16282
34244-17282
34246-00282
34248-00282
34270-00283
34270-01283
34280-00284
34290-00284
34295-00284
34815-03178
34815-04178
34815-06178
34816-13177
34816-16177
34816-19177

41

41011-15170
41011-19170
41015-23170
41015-26170

41017-23 170	41098-20 176	41238-19 243	41297-09 227	41430-01 232
41017-26 170	41141-25 217	41238-19-05 244	41297-10 227	41430-02 232
41019-14 170	41142-19 217	41238-19-10 244	41297-11 227	41430-03 232
41020-00 170	41143-21 217	41238-19-15 244	41297-12 227	41431-01 232
41025-01 172	41146-18 217	41239-19 243	41298-12 227	41431-02 232
41025-02 172	41146-24 217	41240-16 244	41299-03 226	41431-03 232
41026-35 172	41147-21 218	41242-19 114	41299-05 226	41432-01 232
41026-50 172	41149-22 218	41243-19 114	41299-07 226	41432-02 232
41027-00 172	41151-24 218	41244-19 114	41300-02 228	41432-03 232
41028-00 172	41155-20 218	41245-19 114	41300-03 228	41440-01 232
41051-20 106	41156-18 219	41249-07 266	41300-04 228	41440-02 232
41052-20 106	41158-01 219	41249-10 266	41300-05 228	41440-03 232
41053-20 106	41158-02 219	41249-13 266	41301-15 228	41441-01 232
41054-20 107	41158-03 219	41249-16 266	41301-20 228	41441-02 232
41056-18 107	41161-01 220	41249-19 266	41301-25 228	41441-03 232
41056-28 107	41161-02 220	41249-22 266	41301-35 228	41442-01 232
41058-18 107	41161-03 220	41250-11 266	41302-01 228	41442-02 232
41058-28 107	41161-04 220	41250-15 266	41302-02 228	41442-03 232
41061-16 108	41161-05 220	41250-18 266	41303-09 229	41444-01 234
41064-16 108	41170-01 250	41253-07 266	41303-12 229	41444-02 234
41068-20 108	41170-02 250	41253-11 266	41303-15 229	41444-03 234
41069-20 108	41170-03 250	41253-15 266	41303-18 229	41445-25 239
41070-29 108	41170-04 250	41253-18 266	41303-25 229	41446-02 239
41074-23 109	41170-05 250	41254-06 267	41303-30 229	41446-03 239
41075-24 109	41170-06 250	41254-10 267	41303-45 229	41446-09 239
41076-03 109	41170-07 250	41254-13 267	41304-06 229	41448-02 233
41076-04 109	41170-08 250	41254-16 267	41304-08 229	41448-03 233
41076-05 109	41170-09 250	41254-19 267	41304-10 229	41448-04 233
41076-07 109	41170-10 250	41254-25 267	41306-00 230	41449-01 233
41077-04 110	41170-11 250	41254-32 267	41306-05 228, 230	41449-02 233
41077-06 110	41170-12 250	41254-38 267	41306-07 228, 230	41449-03 233
41077-08 110	41170-13 250	41290-21 226	41306-09 228, 230	41450-00 234
41077-10 110	41170-14 250	41294-40 226	41306-12 228	41451-01 235
41078-23 111	41170-15 250	41295-04 227	41308-00 230	41451-02 235
41079-21 111	41210-23 253	41295-05 227	41401-16 147	41451-03 235
41080-19 112	41211-23 253	41295-06 227	41404-17 148	41452-01 235
41081-19 112	41213-23 253	41295-07 227	41405-17 148	41452-02 235
41083-19 112	41221-00 254	41295-08 227	41405-27 148	41452-03 235
41085-20 112	41222-00 254	41295-08-13 227	41406-01 149	41453-01 235
41090-33 173	41223-00 254	41295-08-16 227	41406-02 149	41453-02 235
41091-31 112	41224-00 254	41295-09 227	41420-01 232	41453-03 235
41091-41 112	41230-01 242	41295-10 227	41420-02 232	41458-20 235
41092-30 173	41230-02 242	41295-10-13 227	41420-03 232	41460-01 236
41092-40 173	41230-03 242	41295-10-16 227	41421-01 232	41460-02 236
41092-50 173	41230-05 242	41295-11 227	41421-02 232	41460-03 236
41092-60 173	41230-06 242	41295-12 227	41421-03 232	41461-01 236
41092-70 173	41231-19 243	41295-12-13 227	41422-01 232	41461-02 236
41093-00 173	41232-19 243	41295-12-16 227	41422-02 232	41461-03 236
41094-00 173	41233-19 243	41295-15 227	41422-03 232	41462-01 236
41095-00 173	41234-19 243	41297-06 227	41297-07 227	41462-02 236
41096-21 174	41236-19 115, 245	41297-07 227	41297-08 227	41462-03 236
41097-22 175	41237-19 115, 245	41297-08 227		41465-01 236

41465-02236	41510-03B.....275	41514-04-23...274	41542-02B.....277	41544-05-23...276
41465-03236	41510-04274	41514-05274	41542-03276	41544-05-23B.....
41466-01236	41510-04B.....275	41514-05-23...274	41542-03B.....277277
41466-02236	41510-05274	41515-01274	41542-04276	41544-05B.....277
41466-03236	41510-05B.....275	41515-01-23...274	41542-04B.....277	41710-08 A.....296
41467-01236	41511-01.....274	41515-01-23B.....	41542-05276	41710-11 A.....296
41467-02236	41511-02.....274275	41542-05B.....277	41710-17 A.....296
41467-03236	41511-03.....274	41515-01B.....275	41543-01276	41711-08 V.....296
41470-01236	41511-04.....274	41515-02274	41543-01-23...276	41711-11 V.....296
41470-02236	41511-05.....274	41515-02-23...274	41543-01-23B.....	41711-17 V.....296
41470-03236	41512-01.....274	41515-02-23B.....277	41712-08 A.....296
41471-01236	41512-01B.....275275	41543-01B.....277	41712-11 A.....296
41471-02236	41512-02274	41515-02B.....275	41543-02276	41712-17 A.....296
41471-03236	41512-02B.....275	41515-03274	41543-02-23...276	41713-08 V.....296
41472-01236	41512-03274	41515-03-23...274	41543-02-23B.....	41713-11 V.....296
41472-02236	41512-03B.....275	41515-03-23B.....277	41713-17 V.....296
41472-03236	41512-04274275	41543-02B.....277	41714-08 A.....296
41475-01236	41512-04B.....275	41515-03B.....275	41543-03276	41714-11 A.....296
41475-02236	41512-05274	41515-04274	41543-03-23...276	41714-17 A.....296
41475-03236	41512-05B.....275	41515-04-23...274	41543-03-23B.....	41715-08 V.....296
41476-01236	41513-01.....274	41515-04-23B...275277	41715-11 V.....296
41476-02236	41513-01-23...274	41515-04B.....275	41543-03B.....277	41715-17 V.....296
41476-03236	41513-01-23B.....	41515-05274	41543-04276	41716-08 A.....296
41477-01236275	41515-05-23...274	41543-04-23...276	41716-11 A.....296
41477-02236	41513-01B.....275	41515-05-23B.....	41543-04-23B.....	41716-17 A.....296
41477-03236	41513-02274275277	41717-08 V.....296
41480-01236	41513-02-23...274	41515-05B.....275	41543-04B.....277	41717-11 V.....296
41480-02236	41513-02-23B.....	41520-03278	41543-05276	41717-17 V.....296
41480-03236275	41520-05278	41543-05-23...276	41718-25 A.....296
41481-01236	41513-02B.....275	41522-03278	41543-05-23B.....	41718-36 A.....296
41481-02236	41513-03274	41522-05278277	41719-08 A.....296
41481-03236	41513-03-23...274	41524-03278	41543-05B.....277	41719-11 A.....296
41482-01236	41513-03-23B.....	41524-05278	41544-01276	41719-17 A.....296
41482-02236275	41526-03278	41544-01-23...276	41719-25 V.....296
41482-03236	41513-03B.....275	41526-05278	41544-01-23B...277	41719-36 V.....296
41490-01237	41513-04274	41527-03278	41544-01B.....277	41720-25 A.....296
41490-02237	41513-04-23...274	41527-05278	41544-02276	41720-36 A.....296
41490-03237	41513-04-23B.....	41529-03278	41544-02-23...276	41721-08 V.....296
41492-01237275	41529-05278	41544-02-23B.....	41721-11 V.....296
41492-02237	41513-04B.....275	41540-01276277	41721-17 V.....296
41492-03237	41513-05274	41540-01B.....277	41544-02B.....277	41721-25 V.....296
41494-01237	41513-05-23...274	41540-02276	41544-03276	41721-36 V.....296
41494-02237	41513-05-23B.....	41540-02B.....277	41544-03-23...276	41730-15297
41494-03237275	41540-03276	41544-03-23B.....	41731-15297
41496-01237	41513-05B.....275	41540-03B.....277277	41801-01268
41496-02237	41514-01274	41540-04276	41544-03B.....277	41802-00271
41496-03237	41514-01-23...274	41540-04B.....277	41544-04276	41802-02268
41510-01274	41514-02274	41540-05276	41544-04-23...276	41803-01270
41510-01B.....275	41514-02-23...274	41540-05B.....277	41544-04-23B.....	41807-00270
41510-02274	41514-03274	41542-01276277	41810-10.....
41510-02B.....275	41514-03-23...274	41542-01B.....277	41544-04B.....277268, 270-271
41510-03274	41514-04274	41542-02276	41544-05276	

93327-23 72	93462-23 245	93620-14 256	R065
93329-23 72	93463-20 245	93660-01 257	R065-020080-003
93331-23 72	93463-23 245	93660-02 257 293
93340-15 62	93464-20 245	93660-03 257	R065-020080-005
93342-15 62	93464-23 245	93660-04 257 293
93342-18 62	93465-20 245	93670-01 258	R065-040000-003
93350-12 63	93465-23 245	93670-02 258 293
93350-13 63	93466-20 245	93670-05 258	R065-040000-005
93351-13 63	93466-23 245	93670-06 258 293
93360-09 63	93467-20 245	93670-09 258	R065-040125-003
93370-14 63	93467-23 245	93670-10 258 293
93370-18 63	93470-20 246	93670-12 258	R065-040125-005
93380-13 16	93470-23 246	93680-01 259 293
93380-15 16	93471-20 246	93680-02 259	R065-040285-003
93380-18 16	93471-23 246	93680-05 259 293
93380-20 16	93472-20 246	93680-06 259	R065-040285-005
93385-21 16	93472-23 246	93680-07 259 293
93385-25 16	93473-20 246	93690-01 259	R065-040285-005
93390-21 16	93473-23 246	93700-03 260 293
93400-01 113	93474-23 246	93700-05 260	
93400-02 113	93475-23 246	93701-03 260	
93401-01 113	93480-23 223	93701-05 260	
93401-02 113	93481-20 223	93702-03 260	
93402-01 113	93482-23 223	93702-05 260	
93402-02 113	93483-23 223	93703-03 260	
93403-01 113	93484-23 223	93703-05 260	
93403-02 113	93485-18 223	93704-24 261	
93405-01 114	93486-21 223	93705-00 261	
93405-02 114	93487-18 223	93710-01 262	
93405-03 114	93490-01 224	93710-02 262	
93405-04 114	93490-02 224	93710-03 262	
93410-01 221	93490-03 224	93710-04 262	
93410-02 221	93490-04 224	93710-05 262	
93410-03 221	93490-05 224	93710-06 262	
93410-05 221	93490-06 224	93710-07 262	
93410-06 221	93500-18 247	93720-01 263	
93410-07 221	93501-23 247	93720-02 263	
93420-01 222	93505-01 248	93720-03 263	
93420-02 222	93505-02 248	93720-04 263	
93420-03 222	93505-03 248	93730-04 264	
93420-04 222	93505-04 248	93730-06 264	
93430-01 189	93506-05 248	93731-04 264	
93430-02 189	93506-08 248	93740-01 264	
93430-03 189	93510-18 249	93740-02 264	
93450-01 115	93600-01 255	93750-01 264	
93450-02 115	93600-02 255	93750-02 264	
93450-04 115	93600-03 255	93750-03 264	
93460-20 245	93605-21 255	93750-04 264	
93460-23 245	93610-11 256	93755-14 47	
93461-20 245	93610-13 256	93756-14 47	
93461-23 245	93610-15 256	93757-14 47	
93462-20 245	93615-01 256		

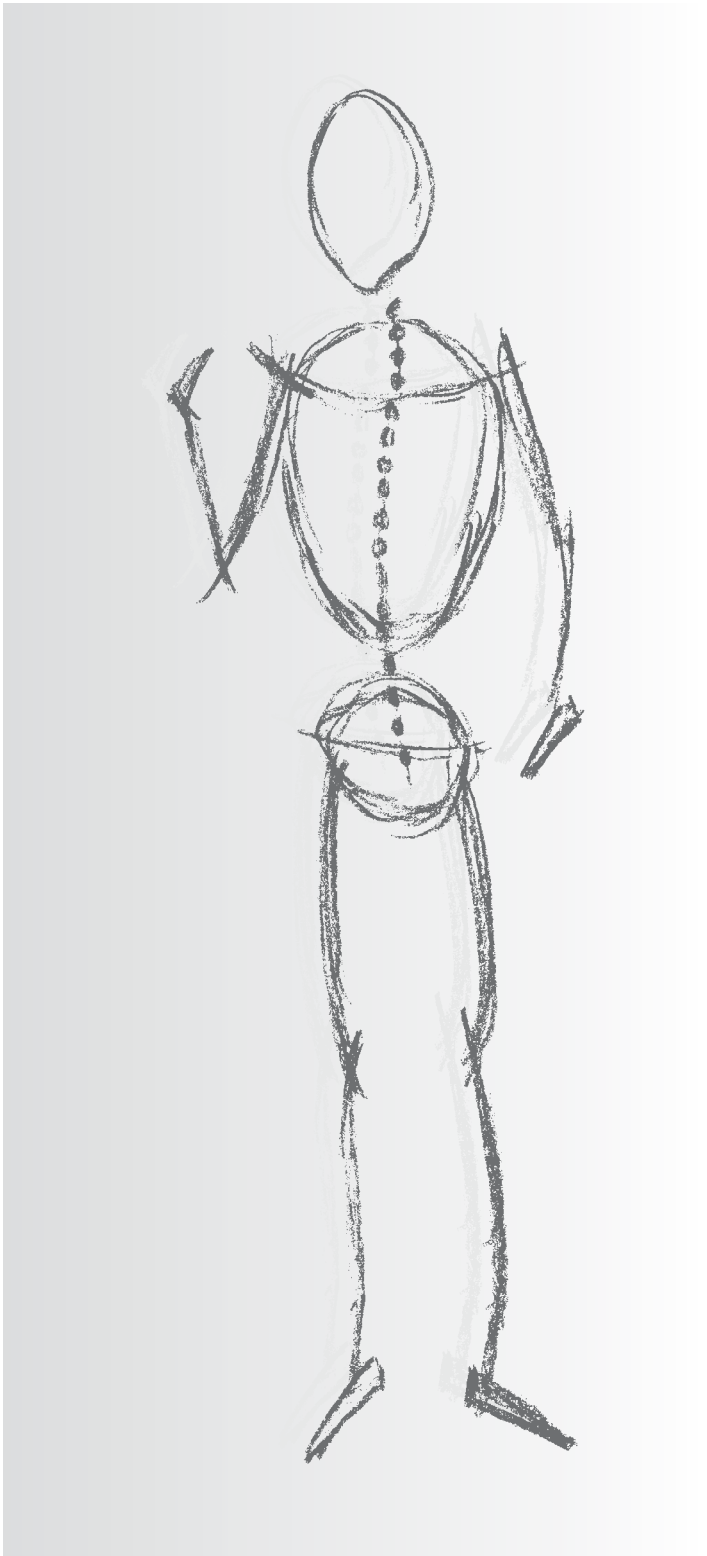

Reda Instrumente GmbH
Gänsäcker 34 - P.O. Box 131
D-78532 Tuttlingen

ALPHABETISCHER INDEX

ALPHABETICAL INDEX

INDEX ALPHABÉTICO

INDICE ALFABETICO

A

AACHEN, Hirnspatel	266
ACLAND, Mikro-Gefäßclips	296
ADLERKREUTZ, Atrauma Anatomische und chirurgische Pinzetten	54
ADSON BABY, Präparier- und Ligaturklemmen	86
ADSON-BROWN, Atrauma Anatomische und chirurgische Pinzetten	52
ADSON-DE BAKEY, Atrauma Anatomische und chirurgische Pinzetten	51
ADSON, Anatomische und chirurgische Pinzetten	51-52
ADSON, Bohrllochzange	177
ADSON, Hohlmeißelzangen	159
ADSON, Hypophyse Pinzetten	253
ADSON, Laminektomie-Wundspreizer	127
ADSON, Micro Anatomische und chirurgische Pinzetten	51-52
ADSON, Nervhaken	108
ADSON, Raspatorien	214
ADSON, Saugrohre	226
ADSON, Wundspreizer	123-124
ALEXANDER, Elevatorien	206
ALM, Wundspreizer	118
Anatomische und chirurgische Pinzetten, ADSON	51-52
Anatomische und chirurgische Pinzetten, POTTS-SMITH	50
ANDERSON ADSON, Zerebellum-Spreizer	126
Anlegezange	81
Anlegezange, RANEY	172
Anlegezangen, MCKENZIE	170
Anlegezangen, OLIVECRONA-TOENNIS	170
Anlegezangen, SMITHWICK	170
Anlegezangen, SWEET	170
Arterienklemmen, CRILE	83
Arterienklemmen, CRILE-RANKIN	83
Arterienklemmen, DANDY	84
Arterienklemmen, HALSTED-MOSQUITO	82
Arterienklemmen, HALSTED-MOSQUITO Micro	82
Arterienklemmen, HARTMANN	81
Arterienklemmen, KELLY	83
Arterienklemmen, KELLY-RANKIN	83
Arterienklemmen, Micro-HARTMANN	81

Atrauma Anatomische und chirurgische Pinzetten, ADLERKREUTZ	54
Atrauma Anatomische und chirurgische Pinzetten, ADSON-BROWN	52
Atrauma Anatomische und chirurgische Pinzetten, ADSON-DE BAKEY	51
Atrauma Anatomische und chirurgische Pinzetten, BROPHY	54
Atrauma Anatomische und chirurgische Pinzetten, CUSHING	53
Atrauma Anatomische und chirurgische Pinzetten, CUSHING-TAYLOR	57
Atrauma Anatomische und chirurgische Pinzetten, DUEHRSEN	55
Atrauma Anatomische und chirurgische Pinzetten, GERALD	56-57
Atrauma Anatomische und chirurgische Pinzetten, GILLIES	56
Atrauma Anatomische und chirurgische Pinzetten, MAYO	58
Atrauma Anatomische und chirurgische Pinzetten, McINDOE	55
Atrauma Anatomische und chirurgische Pinzetten, SEMKEN	56
Atrauma Anatomische und chirurgische Pinzetten, TAYLOR	58
Atrauma Anatomische und chirurgische Pinzetten, WANGENSTEEN	58
Atrauma Anatomische und chirurgische Pinzetten, WAUGH	53
Atrauma Mikro Pinzetten, DE BAKEY	66-67
Atrauma-Bulldogklemmen	77-79
Atrauma-Bulldogklemmen, DE BAKEY	79
Atrauma-Bulldogklemmen, DE BAKEY-HESS	80
Atrauma-Bulldogklemmen, GLOVER	79-80
Atraumatische Pinzetten, DE BAKEY	68

B

BABINSKY, Perkussionshämmer	8
BABY-METZENBAUM BLACK, Präparierscheren	25
BACON, Hohlmeißelzangen	162
Bandscheibenstanzen	274-278
Bandscheibenstanzen zerlegbar FERRIS-SMITH-KERRISON	276

Bandscheibenstanzen zerlegbar schwarz beschichtet, FERRIS-SMITH-KERRISON	275, 277
Bandscheibenstanzen, COLCLOUGH	278
Bandscheibenstanzen, FERRIS-SMITH-KERRISON	274-275
BANE-HARTMANN, Hohlmeißelzangen	160
BARON, Saugrohre	226
BARRAQUER Mikro-Nadelhalter	94
BAUMGARTNER, Nadelhalter	92
BECKMANN-ADSON, (CONE) Wundspreizer	124
BECKMANN-ADSON, Laminektomie-Wundspreizer	128
BECKMANN-EATON, Laminektomie-Wundspreizer	130
BECKMANN, Laminektomie-Wundspreizer	130
BERLINER, Perkussionshämmer	8
BEYER, Hohlmeißelzangen	161, 163
BIEMER, Gefäßspreizer	244
BIEMER, Venenschere	44-45
Bipolare Koagulation	286-291
Bipolare Saugpinzetten	292
Bipolare Verbindungskabel	293
BLACK, Präparierscheren	25
Blätter für Cervicalspreizer	142-143
BÖHLER, Hohlmeißelzangen	163
BÖHLER, Knochensplitterzangen	168
Bohrapparate	282
Bohrapparate, BUNELL	283
Bohrapparate, RALK	283
Bohrapparate, REDA	284
Bohrer, CUSHING	282
Bohrer, ERRICO	282
Bohrer, MC KENZIE	282
Bohrloch-Schutzzange	176
Bohrlochzange, ADSON	177
BOIES, Elevatorien	207
BROPHY, Atrauma Anatomische und chirurgische Pinzetten	54
BROWN, Micro Anatomische und chirurgische Pinzetten	53
BRUNS, Scharfe Löffel	184
BUCK, Perkussionshämmer	8
Bulldogklemmen, DE BAKEY-DIETHRICH Mini	76
Bulldogklemmen, DIEFFENBACH	81
Bulldogklemmen, DIETHRICH Mini	76
Bulldogklemmen, JOHNS-HOPKINS	81

BUNELL, Bohrapparate.....	283
BUSHE, Scharfe Löffel.....	187

A

CAPENER, Wirbelsäulenmeißel.....	199
CAROLL, Sehnenfaßzange.....	89
CASPAR, Cervicales Wirbelkörper Distractions System.....	154
CASPAR, Explorations und Koagulationshäkchen.....	113
CASPAR, Fadengabel.....	247
CASPAR, Knochenspanhalter und Einsetzinstrument.....	190
CASPAR, Laminektomie Zangen.....	236-237
CASPAR, Laminektomie- Wundspreizer.....	134
CASPAR, Lumbal- Wundspreizer.....	150, 152
CASPAR, Mikro-Raspatorien.....	223-224
CASPAR, Nervwurzelhaken.....	110
CASPAR, Scharfe Löffel.....	183
CASPAR, Skalpell-Griffe.....	16
CASPAR, Spekula für lumbale Bandscheibenoperationen.....	151
CASPAR, Stößel.....	191
CASTROVIEJO Mikro, Nadelhalter.....	95
CASTROVIEJO, Klängenbrecher.....	17
CASTROVIEJO, Mikro Scheren.....	36
Cervical, Retraktoren.....	137-141
Cervicales Wirbelkörper Distractions System.....	154-155
Cervicales Wirbelkörper Distractions System, CASPAR.....	154
Cervicalspreizer, CLOWARD.....	137-140
Chirurgische Scheren, DEEVER.....	21
Chirurgische Scheren, KELLY.....	21
Chirurgische Scheren, STANDARD.....	20
Chirurgische, Scheren.....	20-21
CITELLI, Stanzen.....	280
CLOWARD, Cervicalspreizer.....	137-140
CLOWARD, Lamina Spreizer.....	147, 149
CLOWARD, Laminektomie Zangen.....	233
CLOWARD, Wundhaken.....	101
COBB, Hohlmeißel.....	196
COBB, Raspatorien.....	213
COBB, Scharfe Löffel.....	181
COLCLOUGH Bandscheibenstanzen.....	278
CONE, Ringkürretten.....	252
CONE, Schädelstanze.....	175

COTTLE-KAZANJIAN, Knochensplitterzangen.....	168
COTTLE, Hämmer.....	10
COTTLE, Pinzetten.....	73
COTTLE, Septum Osteotom.....	200
CRILE-RANKIN, Arterienklemmen.....	83
CRILE-WOOD, Nadelhalter.....	92
CRILE, Arterienklemmen.....	83
CRILE, Nervhaken.....	107
CRUTCHFIELD, Schädelhalter Kopfhautklammer.....	172
CUSHING (LITTLE-JOKER), Raspatorien.....	203
CUSHING-LANDOLT, Hypophysektomie Instrumente.....	255
CUSHING-TAYLOR, Atrauma Anatomische und chirurgische Pinzetten.....	57
CUSHING, Atrauma Anatomische und chirurgische Pinzetten.....	53
CUSHING, Bohrer.....	282
CUSHING, Durahaken.....	107
CUSHING, Elevatorien.....	204
CUSHING, Hirnspatel.....	266
CUSHING, Laminektomie Zangen.....	232
CUSHING, Wundhaken.....	101

D

D'ERRICO, Nervwurzelhaken.....	111
DANDY, Arterienklemmen.....	84
DANDY, Durahaken.....	106
DANDY, Nervhaken.....	106
DANDY, Neurochirurgie-Schere.....	33
DAUBENSPECK, Scharfe Löffel.....	185
DAVIS, Dura-Dissektor.....	217-218
DAVIS, Hirnspatel.....	267
DE BAKEY (POTTS-SMITH), Gefäßscheren.....	30
DE BAKEY-DIETRICH Mini, Bulldogklemmen.....	76
DE BAKEY-HESS, Atrauma- Bulldogklemmen.....	80
DE BAKEY, Atrauma Mikro Pinzetten.....	66-67
DE BAKEY, Atrauma- Bulldogklemmen.....	79
DE BAKEY, Atraumatische Pinzetten.....	68
DE BAKEY, Gefäßscheren.....	31-32
DE BAKEY, Nadelhalter.....	93
DEEVER, Chirurgische Scheren.....	21
DECKER, Laminektomie Zangen.....	234

DEJERINE, Perkussionshämmer.....	8
DEMARTEL, Führungsinstrument.....	173
DeVILBISS, Schädelzange.....	174
DIEFFENBACH, Bulldogklemmen.....	81
DIETRICH Mini, Bulldogklemmen.....	76
DIETRICH, Gefäßscheren.....	29-30
Dissektor, GORNEY.....	207
Dissektor, HARDY-FAHLBUSCH.....	258
Dissektor, LANDOLT-REULEN.....	262
Dissektor, RHOTON.....	250
Dissektoren, PENFIELD.....	220
Doppelsonde, JACOBSON.....	243
DOYEN, Raspatorien.....	208-209
Draht-Blechscherer, UNIVERSAL.....	34
Drahtsäge-Handgriff, GIGLI.....	173
Drahtsäge-Handgriff, REDA.....	173
Drahtsäge, OLIVECRONA.....	173
DUEHRSEN, Atrauma Anatomische und chirurgische Pinzetten.....	55
Dura-Dissektor.....	218
Dura-Dissektor, DAVIS.....	217-218
Dura-Dissektor, FRAZIER.....	219
Dura-Dissektor, HOEN.....	219
Dura-Dissektor, MILLIGAN.....	218
Dura-Dissektor, OLIVECRONA.....	217
Dura-Dissektor, SACHS.....	217
Dura-Dissektor, TOENNIS.....	217
Dura-Dissektor, WOODSON.....	219
Durahaken, CUSHING.....	107
Durahaken, DANDY.....	106
Durahaken, FISCH.....	243
Duraschere, SCHMIEDEN-TAYLOR.....	34

E

ECHLIN, Hohlmeißelzangen.....	167
Elevatorien.....	211-216
Elevatorien, ALEXANDER.....	206
Elevatorien, BOIES.....	207
Elevatorien, CUSHING.....	204
Elevatorien, HOEN.....	205
Elevatorien, JANSEN.....	202
Elevatorien, KEY.....	214
Elevatorien, KÖNIG.....	206
Elevatorien, LANGENBECK.....	205
Elevatorien, QUERVAIN.....	204
Elevatorien, SEBILEAU.....	204
Elevatorien, SEDILLOT.....	204
Elevatorium, FREER.....	216
Elevatorium, JOSEPH.....	215
Elevatorium, MC DONALD.....	215
Elevatorium, ROGER.....	216

Elevatorium, SEWALL	215
Elevatorium, WATSON-CHEYNE	215
Enukleator, HARDY	258
Enukleator, LANDOLT	259
ERRICO, Bohrer	282
Explorations und Koagulationshäkchen, CASPAR	113

F

Fadenführer, YASARGIL	114
Fadengabel, CASPAR	247
Fadengabel, JACOBSON	247
FAHLBUSCH, Hypophysenküretten	262
FAHLBUSCH, Kürette	262
FAHLBUSCH, Löffel	262
FAHLBUSCH, Mikro-Schere	263
FARABEUF-COLLIN, Raspatorien	202-203
FARABEUF, Raspatorien	202
Faßzange, YASARGIL-NICOLA	263
FAVALORO, Gefäßscheren	32
Feine Scheren, GRADLE	28
Feine Scheren, STEVENS	28
Feine, Scheren	27
Feines Häkchen, FISCH	243
FERGUSON, Saugrohre	226-227
FERRIS-SMITH-KERRISON, Bandscheibenstanzen	274-275
FERRIS-SMITH-KERRISON, Bandscheibenstanzen zerlegbar	276
FERRIS-SMITH-KERRISON, Bandscheibenstanzen zerlegbar schwarz beschichtet	275, 277
FERRIS-SMITH, Laminektomie Zangen	235
FISCH, Durahaken	243
FISCH, Feines Häkchen	243
FISCH, Mikro-Häkchen	115
Flachmeißel, LEXER	197
Flachmeißel, LEXER MINI	197
Flachmeißel, STILLE	192
FOMON, Raspatorien	207
FRAZIER, Dura-Dissektor	219
FRAZIER, Hauthäkchen	100
FRAZIER/FERGUSON, Saugrohre	227
FREER, Elevatorium	216
FREER, Hauthäkchen	100
FRIEDMAN Mini, Hohlmeißelzangen	158
FRIEDMAN, Hohlmeißelzangen	158

FRYKHOLM, Hohlmeißelzangen	167
FUCHSIG, Präparier- und Ligaturklemmen	86
Führungsinstrument, DEMARTEL	173

G

Gabelförmige HOSOBUCHI	259
Galea Haken, YASARGIL	112
GALT, Schädeltrephine	177
Gefäßdilatoren	60
Gefäßscheren	29-32
Gefäßscheren, DE BAKEY	31-32
Gefäßscheren, DE BAKEY (POTTS-SMITH)	30
Gefäßscheren, DIETRICH	29-30
Gefäßscheren, FAVALORO	32
Gefäßscheren, MILLS	29
Gefäßscheren, POTTS-DE MARTEL	29
Gefäßscheren, POTTS-SMITH	30-31
Gefäßspreizer, BIEMER	244
GELPI, Wundspreizer	146
GEMINI, Präparier- und Ligaturklemmen	87
GERALD, Atrauma Anatomische und chirurgische Pinzetten	56-57
Gewebekralle	249
GIERTZ-STILLE, Rippenscheren	48
GIGLI STRULLY, Handgriff	173
GIGLI, Drahtsäge-Handgriff	173
GILLIES, Atrauma Anatomische und chirurgische Pinzetten	56
GILLIES, Hauthäkchen	100
GLOVER, Atrauma- Bulldogklemmen	79-80
GORNEY, Dissektor	207
GRADLE, Feine Scheren	28
GRAHAM, Nervhaken	108
GUILLEN, Saugraspatorium	230

H

HAJEK-KOFLER, Stanzen	279-280
Häkchen, RHOTON	250
HALLE, Scharfe Löffel	182
HALSEY, Nadelhalter	92
HALSTED-MOSQUITO Micro, Arterienklemmen	82
HALSTED-MOSQUITO, Arterienklemmen	82
Hämmer, COTTLE	10
Hämmer, OMBREDANNE	10
Hämmer, WAGNER	10

Hämmer, WILLIGER	9
Handbohrapparat, HUDSON	282
Handgriff, GIGLI STRULLY	173
HARDY-FAHLBUSCH, Dissektor	258
HARDY, Enukleator	258
HARDY, Hypophysektomie- Instrumente	258, 261
HARDY, Hypophysenküretten	260
HARDY, Implantationsgabel	258
HARTMANN, Arterienklemmen	81
HARVEY-JACKSON, Laminektomie-Wundspreizer	131
Hauthäkchen, FRAZIER	100
Hauthäkchen, FREER	100
Hauthäkchen, GILLIES	100
Hauthäkchen, JOSEPH	100
HEIFETZ, Hirnspatel	267
HEIFETZ, Pinzetten zum Fassen von Gewebe	71
Hemilaminektomie Spreizer, MARKHAM-MEYERDING	144
Hemilaminektomie, Spreizer	144-145
HENLEY, Wundspreizer	121
HESS, Nervwurzelhaken	109
Hirnspatel, AACHEN	266
Hirnspatel, CUSHING	266
Hirnspatel, DAVIS	267
Hirnspatel, HEIFETZ	267
Hirnspatel, OLIVECRONA	266
HOEN, Dura-Dissektor	219
HOEN, Elevatorien	205
HOEN, Laminektomie Zangen	234
Hohlmeißel, COBB	196
Hohlmeißel, SMITH-PETERSEN	193
Hohlmeißel, STILLE	192
Hohlmeißel, ZIELKE	198
Hohlmeißelzangen, ADSON	159
Hohlmeißelzangen, BACON	162
Hohlmeißelzangen, BANE-HARTMANN	160
Hohlmeißelzangen, BEYER	161, 163
Hohlmeißelzangen, BÖHLER	163
Hohlmeißelzangen, ECHLIN	167
Hohlmeißelzangen, FRIEDMAN	158
Hohlmeißelzangen, FRIEDMAN Mini	158
Hohlmeißelzangen, FRYKHOLM	167
Hohlmeißelzangen, JANSEN	160
Hohlmeißelzangen, KLEINERT-KUTZ	161
Hohlmeißelzangen, LEKSELL-STILLE	166

Hohlmeißelzangen, LEMPERT..	160-161
Hohlmeißelzangen, LUER	159
Hohlmeißelzangen, MARQUARDT ..	164
Hohlmeißelzangen, MAYFIELD	163
Hohlmeißelzangen, MICRO FRIEDMAN	158
Hohlmeißelzangen, OLIVECRONA ..	160
Hohlmeißelzangen, RUSKIN	164
Hohlmeißelzangen, SAUERBRUCH	166
Hohlmeißelzangen, SEMB	167
Hohlmeißelzangen, SMITH-PETERSEN	162
Hohlmeißelzangen, STELLBRINK....	158
Hohlmeißelzangen, STILLE-LUER....	165
Hohlmeißelzangen, STILLE-RUSKIN	165
Hohlmeißelzangen, ZAUFAL-JANSEN	163
HOLSHER, Nervwurzelhaken	109
HOLZHEIMER, Wundspreizer	118
HORSLEY, Dura-Dissektor	218
HOSOBUCHI, gabelförmige	259
HOUSE, Saugrohre	229
HUDSON, Handbohrapparat	282
HUNT, Pinzetten zum Fassen von Gewebe	69-70
Hypophyse Pinzetten, ADSON	253
Hypophyse-Zange, LANDOLT	239
Hypophyse-Zange, OLDBERG	239
Hypophyse-Zange, YASARGIL	239
Hypophysektomie Instrumente ..	255-264
Hypophysektomie Instrumente, CUSHING-LANDOLT	255
Hypophysektomie Instrumente, LANDOLT	256, 259
Hypophysektomie Instrumente, PAPAVERO-CASPAR	256
Hypophysektomie Instrumente, PAPAVERO-HARTMANN	256
Hypophysektomie-Instrumente, HARDY	258, 261
Hypophysektomie-Instrumente, NICOLA	257
Hypophysenküretten, FAHLBUSCH ..	262
Hypophysenküretten, HARDY	260
Hypophysenküretten, LANDOLT-REULEN	262

I

Implantationsgabel, HARDY	258
---------------------------------	-----

INGE, Lamina Spreizer	148
-----------------------------	-----

J

JACOBSON, Doppelsonde	243
JACOBSON, Fadengabel	247
JACOBSON, Knopfsonde	243
JACOBSON, Mikro Scheren	44-45
JACOBSON, Mikro-Gefäßmesser	115
JAMESON WERBER, Präparierscheren	26
JANSEN-GRUENWALD, Pinzetten	73
JANSEN, Elevatorien	202
JANSEN, Hohlmeißelzangen	160
JANSEN, Pinzetten	73
JANSEN, Scharfe Löffel	188
JANSEN, Wundspreizer	118
JOHNS-HOPKINS, Bulldogklemmen ..	81
JOSEPH, Elevatorium	215
JOSEPH, Hauthäkchen	100
JOSEPH, Raspatorien	207

K

KELLY-RANKIN, Arterienklemmen	83
KELLY, Arterienklemmen	83
KELLY, Chirurgische Scheren	21
KERRISON, Stanzen	279
KEY, Elevatorien	214
KILNER, Präparierscheren	26
Klammerblock	170
KLEINERT-KUTZ, Hohlmeißelzangen	161
Klingenbrecher, CASTROVIEJO	17
Klingenbrecher, REDA	17
Klingenbrecher, TROUTMAN-CHRIS	17
KNIGHTON, Laminektomie- Wundspreizer	132
Knochenspanhalter und Einsetzinstrument, CASPAR	190
Knochensplitterzangen	168-169
Knochensplitterzangen, BÖHLER	168
Knochensplitterzangen, COTTLE-KAZANJIAN	168
Knochensplitterzangen, LISTON	168
Knochensplitterzangen, MC INDOE ..	168
Knochensplitterzangen, RUSKIN-LISTON	168
Knochensplitterzangen, SEMB	169
Knochensplitterzangen, STAMM	168
Knochensplitterzangen, STILLE-HORSLEY	169

Knochensplitterzangen, STILLE-LISTON	169
Knopfsonde, JACOBSON	243
Knopfsonde, RHOTON	250
Knüpfpinzetten, Mikro	61-63
KOCHER-LANGENBECK, Wundhaken	102
KOCHER, Wundhaken	103
KÖNIG, Elevatorien	206
KOOS, Messer	243
KOOS, Mikro Gefäßmesser	242
Kopfhautspreizer, SCALP-CONTOUR	125
Kopfschwanzzangen, MARTEL	85
KRAYENBÜHL, Nerv und Gefäßhäkchen	114
Kürette	254
Kürette, FAHLBUSCH	262
Kürette, LANDOLT	259
Kürette, NICOLA	257

L

LAMBOTTE, Osteotome	194
LAMBOTTE, Raspatorien	203
Lamina Spreizer, CLOWARD	147, 149
Lamina Spreizer, INGE	148
Laminektomie Zangen	232-238
Laminektomie Zangen, CASPAR	236-237
Laminektomie Zangen, CLOWARD ..	233
Laminektomie Zangen, CUSHING ..	232
Laminektomie Zangen, DECKER	234
Laminektomie Zangen, FERRIS-SMITH	235
Laminektomie Zangen, HOEN	234
Laminektomie Zangen, LOVE-GRUENWALD	232
Laminektomie Zangen, SCHLESINGER	233
Laminektomie Zangen, SPURLING ..	232
Laminektomie Zangen, WAGNER	235
Laminektomie Zangen, WEIL-BLAKESLEY	238
Laminektomie-Wundspreizer	127-137
Laminektomie-Wundspreizer, ADSON	127
Laminektomie-Wundspreizer, BECKMANN	130
Laminektomie-Wundspreizer, BECKMANN-ADSON	128

NEIVERT, Nadelhalter.....	92
Nerv und Gefäßhäkchen,	
KRAYENBÜHL.....	114
Nerv-Präparierscheren,	
TOENNIS-ADSON.....	27
Nervhaken, ADSON.....	108
Nervhaken, CRILE.....	107
Nervhaken, DANDY.....	106
Nervhaken, GRAHAM.....	108
Nervhaken, SACHS.....	108
Nervhaken, SMITHWICK.....	108
Nervrädchen, WARTENBERG.....	11
Nervwurzelhaken, CASPAR.....	110
Nervwurzelhaken, D'ERRICO.....	111
Nervwurzelhaken, HESS.....	109
Nervwurzelhaken, HOLSHER.....	109
Nervwurzelhaken, LOVE.....	111-112
Nervwurzelhaken, SCOVILLE... ..	109, 112
Neurochirurgie-Schere, DANDY.....	33
Neurochirurgie-Schere, STRULLY.....	33
NICOLA, Hypophysektomie-	
Instrumente.....	257
NICOLA, Kürette.....	257
NICOLA, Mikro-Schere.....	263
NICOLA, Raspatorium.....	257
NORFOLK-NORWICH,	
Wundspreizer.....	122

O

OKONEK-YASARGIL,	
Tumorgabeln.....	248
OLDBERG, Hypophyse-Zange.....	239
OLIVECRONA-TOENNIS,	
Anlegezangen.....	170
OLIVECRONA, Drahtsäge.....	173
OLIVECRONA, Dura-Dissektor.....	217
OLIVECRONA, Hirnspatel.....	266
OLIVECRONA, Hohlmeißelzangen... ..	160
OLIVECRONA, Trigemiuscheren.....	33
OMBREDANNE, Hämmer.....	10
Osteotom, Septum.....	200
Osteotome, LAMBOTTE.....	194
Osteotome, LEXER.....	197
Osteotome, LEXER MINI.....	197
Osteotome, MINI-LAMBOTTE.....	195
Osteotome, STILLE.....	192

P

PAPAVERO-CASPAR,	
Hypophysektomie Instrumente.....	256

PAPAVERO-HARTMANN,	
Hypophysektomie Instrumente.....	256
PENFIELD, Dissektoren.....	220
Perkussionshämmer, BABINSKY.....	8
Perkussionshämmer, BERLINER.....	8
Perkussionshämmer, BUCK.....	8
Perkussionshämmer, DEJERINE.....	8
Perkussionshämmer,	
TAYLOR USA Mod.....	8
Perkussionshämmer, TROEMNER.....	8
Pinzetten zum Fassen von	
Gewebe, HEIFETZ.....	71
Pinzetten zum Fassen von	
Gewebe, HUNT.....	69-70
Pinzetten zum Fassen von	
Gewebe, SAMII.....	72
Pinzetten zum Fassen von	
Gewebe, YASARGIL.....	69, 71
Pinzetten zum Fassen von	
Gewebe, YASARGIL-SAMII.....	71
Pinzetten, COTTLE.....	73
Pinzetten, JANSEN.....	73
Pinzetten, JANSEN-GRUENWALD.....	73
Pinzetten, LUCAE.....	73
PLESTER, Saugrohre.....	229
PLESTER, Wundspreizer.....	120, 122
POTTS-DE MARTEL,	
Gefäßscheren.....	29
POTTS-SMITH Gefäßscheren.....	30-31
POTTS-SMITH, Anatomische	
und chirurgische Pinzetten.....	50
POTTS-YASARGIL, Mikro	
Scheren.....	44-45
Präparier- und Ligaturklemmen,	
ADSON BABY.....	86
Präparier- und Ligaturklemmen,	
FUCHSIG.....	86
Präparier- und Ligaturklemmen,	
GEMINI.....	87
Präparier- und Ligaturklemmen, MIX-	
TER, BABY.....	88
Präparierscheren.....	22-27
Präparierscheren,	
BABY-METZENBAUM BLACK.....	25
Präparierscheren, BLACK.....	25
Präparierscheren,	
JAMESON WERBER.....	26
Präparierscheren, KILNER.....	26
Präparierscheren, LEXER.....	22
Präparierscheren, MAYO.....	22
Präparierscheren, MAYO-STILLE.....	22
Präparierscheren, METZENBAUM.....	23

Präparierscheren,	
METZENBAUM BLACK.....	24
Präparierscheren,	
METZENBAUM FINO.....	23
Präparierscheren, Mikro.....	46
Präparierscheren, REYNOLDS.....	26
Präparierscheren, YASARGIL.....	41-42
Prüf- und Meßinstrumente.....	11

Q

QUERVAIN, Elevatorien.....	204
----------------------------	-----

R

RALK, Bohraparate.....	283
RANEY, Anlegezange.....	172
Raspatorien, ADSON.....	214
Raspatorien, COBB.....	213
Raspatorien,	
CUSHING (LITTLE-JOKER).....	203
Raspatorien, DOYEN.....	208-209
Raspatorien, FARABEUF.....	202
Raspatorien,	
FARABEUF-COLLIN.....	202-203
Raspatorien, FOMON.....	207
Raspatorien, JOSEPH.....	207
Raspatorien, LAMBOTTE.....	203
Raspatorien, MATSON.....	210
Raspatorien,	
MATSON-ALEXANDER.....	210
Raspatorien, MOLT.....	206
Raspatorien, SEDILLOT.....	203
Raspatorien, SELDIN.....	207
Raspatorien, WAGNER.....	213
Raspatorien, WILLIGER.....	206
Raspatorium, LANDOLT-REULEN... ..	262
Raspatorium, NICOLA.....	257
Raspatorium, RHOTON.....	250
REDA, Bohraparate.....	283
REDA, Drahtsäge-Handgriff.....	173
REDA, Klängenbrecher.....	17
REDA, Scharfe Löffel.....	186-187
Retraktor System, LEYLA.....	268-272
Retraktor System, YASARGIL... ..	268-272
Retraktoren, Cervical.....	137-141
REYNOLDS, Präparierscheren.....	26
RHOTON, Dissektor.....	250
RHOTON, Häkchen.....	250
RHOTON, Knopfsonde.....	250
RHOTON, Raspatorium.....	250
RHOTON, spatelförmig.....	250
Ring Pinzetten, Mikro.....	65

Ringkürretten, CONE.....	252
Rippenscheren, GIERTZ-STILLE.....	48
Rippenscheren, SAUERBRUCH.....	48
Rippenscheren, SAUERBRUCH-FREY.....	48
ROGER, Elevatorium.....	216
RUSKIN-LISTON, Knochensplitterzangen.....	168
RUSKIN, Hohlmeißelzangen.....	164
RYDER, Nadelhalter.....	93

S

SACHS, Dura-Dissektor.....	217
SACHS, Nervhaken.....	108
SAMII, Lanzettenmesser.....	246
SAMII, Pinzetten zum Fassen von Gewebe.....	72
SAMII, Tumormesser.....	245-246
SAUERBRUCH-FREY, Rippenscheren.....	48
SAUERBRUCH, Hohlmeißelzangen.....	166
SAUERBRUCH, Rippenscheren.....	48
Saugraspatorium, GUILLEN.....	230
Saugrohre.....	226-230
Saugrohre, ADSON.....	226
Saugrohre, BARON.....	226
Saugrohre, FERGUSSON.....	226-227
Saugrohre, FRAZIER/FERGUSSON.....	227
Saugrohre, HOUSE.....	229
Saugrohre, PLESTER.....	229
Saugrohre, WULLSTEIN.....	230
Saugrohre, YASARGIL.....	228
Saugrohre, ZÖLLNER.....	228
SCALP-CONTOUR, Kopfhautspreizer.....	125
Schädelhalter Kopfhautklammer, CRUTCHFIELD.....	172
Schädelstanze, CONE.....	175
Schädeltrephine, GALT.....	177
Schädelzange, DeVILBISS.....	174
Scharfe Löffel, BRUNS.....	184
Scharfe Löffel, BUSHE.....	187
Scharfe Löffel, CASPAR.....	183
Scharfe Löffel, COBB.....	181
Scharfe Löffel, DAUBENSPECK.....	185
Scharfe Löffel, HALLE.....	182
Scharfe Löffel, JANSEN.....	188
Scharfe Löffel, LEMPERT.....	186
Scharfe Löffel, REDA.....	186-187

Scharfe Löffel, SCOVILLE.....	183
Scharfe Löffel, SPINAL.....	182
Scharfe Löffel, SPRATT.....	180
Scharfe Löffel, VOLKMANN.....	188
Scheren, Chirurgische.....	20-21
Scheren, Feine.....	27
Scheren, Mikro.....	35-46, 266
SCHLESINGER, Laminektomie Zangen.....	233
SCHMIEDEN-TAYLOR, Duraschere.....	34
SCOVILLE-HAVERFIELD, Laminektomie-Wundspreizer.....	135
SCOVILLE-RICHTER, Laminektomie-Wundspreizer.....	136
SCOVILLE, Laminektomie-Wundspreizer.....	135
SCOVILLE, Nervwurzelhaken.....	109, 112
SCOVILLE, Scharfe Löffel.....	183
SEBILEAU, Elevatorien.....	204
SEDILLOT, Elevatorien.....	204
SEDILLOT, Raspatorien.....	203
Sehnenfaßzange, CAROLL.....	89
SELDIN, Raspatorien.....	207
SEMB, Hohlmeißelzangen.....	167
SEMB, Knochensplitterzangen.....	169
SEMKEN, Atrauma Anatomische und chirurgische Pinzetten.....	56
Septum Osteoto, COTTLE.....	200
Septum, Osteotom.....	200
SEWALL, Elevatorium.....	215
Skalpell-Griffe.....	14-16
Skalpell-Griffe, CASPAR.....	16
Skalpell-Griffe, LANDOLT.....	16
SMITH-PETERSEN, Hohlmeißel.....	193
SMITH-PETERSEN, Hohlmeißelzangen.....	162
SMITHWICK, Anlegezangen.....	170
SMITHWICK, Nervhaken.....	108
spatelförmig, RHOTON.....	250
Spekula für lumbale Bandscheibenoperationen, CASPAR.....	151
SPINAL, Scharfe Löffel.....	182
Spinalhaken, TAYLOR.....	105
SPRATT, Scharfe Löffel.....	180
Spreizer, Hemilaminektomie.....	144-145
Spreizer, MEYERDING.....	144
Spreizer, WILLIAMS.....	145
Spreizzange zum Spreizen der Spekula, LANDOLT.....	255
SPURLING, Laminektomie Zangen.....	232
STAMM, Knochensplitterzangen.....	168

STANDARD, Chirurgische Scheren.....	20
Stanzen.....	279-280
Stanzen, CITELLI.....	280
Stanzen, HAJEK-KOFLER.....	279-280
Stanzen, KERRISON.....	279
STELLBRINK, Hohlmeißelzangen.....	158
STEVENS, Feine Scheren.....	28
STILLE-HORSLEY, Knochensplitterzangen.....	169
STILLE-LISTON, Knochensplitterzangen.....	169
STILLE-LUER, Hohlmeißelzangen.....	165
STILLE-RUSKIN, Hohlmeißelzangen.....	165
STILLE, Flachmeißel.....	192
STILLE, Hohlmeißel.....	192
STILLE, Osteotome.....	192
Stimmgabel.....	11
Stößel, CASPAR.....	191
STRULLY, Neurochirurgie-Schere.....	33
stumpfes, LANDOLT.....	259
SWEET, Anlegezangen.....	170

T

TAYLOR USA Mod, Perkussionshämmer.....	8
TAYLOR, Atrauma Anatomische und chirurgische Pinzetten.....	58
TAYLOR, Laminektomie- Wundspreizer.....	135
TAYLOR, Spinalhaken.....	105
TOENNIS-ADSON, Nerv-Präparierscheren.....	27
TOENNIS, Dura-Dissektor.....	217
TRAVERS, Wundspreizer.....	123
Trepphine, MICHELE.....	180
Trigeminusscheren, OLIVECRONA.....	33
TROEMNER, Perkussionshämmer.....	8
TROUTMAN-CHRIS, Klingenbrecher.....	17
Tumor-Faßzange, LANDOLT.....	239
Tumorgabeln, OKONEK-YASARGIL.....	248
Tumorgabeln, YASARGIL.....	248
Tumormesser, SAMII.....	245-246
Tumorschere.....	47

U

Uhrmacherpinzette.....	59-60
Ultra-Light-Pinzetten.....	64
UNIVERSAL, Draht-Blechscherer.....	34

V

VANNAS, Mikro Scheren... 37, 42, 44-45	
Venenschere, BIEMER.....	44-45
Verlängerungsstück.....	282
VOLKMANN, Löffel.....	180
VOLKMANN, Scharfe Löffel.....	188

W

WAGNER, Hämmer.....	10
WAGNER, Laminektomie Zangen.....	235
WAGNER, Raspatorien.....	213
WALTON, Laminektomie- Wundspreizer.....	133
WANGENSTEIN, Atrauma Anatomische und chirurgische Pinzetten.....	58
WARTENBERG, Nervrädchen.....	11
WATSON-CHEYNE, Elevatorium.....	215
WAUGH, Atrauma Anatomische und chirurgische Pinzetten.....	53
WEIL-BLAKESLEY, Laminektomie Zangen.....	238
WEITLANER-WULLSTEIN, Wundspreizer.....	119
WEITLANER, Wundspreizer.....	119
WILLIAMS, Spreizer.....	145
WILLIGER, Hämmer.....	9
WILLIGER, Raspatorien.....	206
Wirbelkörper Distraktions System.....	156
Wirbelsäulenmeißel, CAPENER.....	199
WOODSON, Dura-Dissektor.....	219
WULLSTEIN, Saugrohre.....	230
WULLSTEIN, Wundspreizer.....	120
Wundhaken, CLOWARD.....	101
Wundhaken, CUSHING.....	101
Wundhaken, KOCHER.....	103
Wundhaken, KOCHER-LANGENBECK.....	102
Wundhaken, LANGENBECK.....	103
Wundhaken, MEYERDING.....	104
Wundspreizer, ADSON.....	123-124
Wundspreizer, ALM.....	118
Wundspreizer, BECKMANN-ADSON (CONE).....	124
Wundspreizer, GELPI.....	146
Wundspreizer, HENLEY.....	121
Wundspreizer, HOLZHEIMER.....	118
Wundspreizer, JANSEN.....	118
Wundspreizer, MAYO-ADAMS.....	122
Wundspreizer, MOLLISON.....	120
Wundspreizer, NORFOLK-NORWICH.....	122

Wundspreizer, PLESTER.....	120, 122
Wundspreizer, TRAVERS.....	123
Wundspreizer, WEITLANER.....	119
Wundspreizer, WEITLANER-WULLSTEIN.....	119
Wundspreizer, WULLSTEIN.....	120

Y

YASARGIL Mikro,-Nadelhalter.....	96
YASARGIL-NICOLA, Faßzange.....	263
YASARGIL-SAMII, Pinzetten zum Fassen von Gewebe.....	71
YASARGIL, Fadenführer.....	114
YASARGIL, Galea Haken.....	112
YASARGIL, Hypophyse-Zange.....	239
YASARGIL, Mikro Gefäßmesser.....	242
YASARGIL, Mikro Pinzetten.....	74
YASARGIL, Mikro Scheren.....	41-42, 44
YASARGIL, Mikro-Löffel.....	189
YASARGIL, Mikro-Raspatorien.....	221-223
YASARGIL, Pinzetten zum Fassen von Gewebe.....	69, 71
YASARGIL, Präparierscheren.....	41-42
YASARGIL, Retraktor System.....	268-272
YASARGIL, Saugrohre.....	228
YASARGIL, Tumorgabeln.....	248

Z

ZAUFAL-JANSEN, Hohlmeißelzangen.....	163
Zerebellum-Spreizer, ANDERSON ADSON.....	126
Zerebellum-Spreizer, MISKIMON.....	126
ZIELKE, Hohlmeißel.....	198
ZÖLLNER, Saugrohre.....	228

A

AACHEN Brain Spatulas	266
ACLAND Micro Vessel Clips.....	296
ADLERKREUTZ Dressing and Tissue Forceps	54
ADSON BABY Dissecting and Ligature Forceps.....	86
ADSON Bone Rongeurs.....	159
ADSON Dressing and Tissue Forceps	51-52
ADSON Drill Guide and Dura Protecting Forceps.....	177
ADSON Hypophyseal Forceps.....	253
ADSON Laminectomy Retractors.....	127
ADSON Micro Dressing and Tissue Forceps	51-52
ADSON Nerve Hook.....	108
ADSON Raspatories.....	214
ADSON Self-retaining Retractors	123-124
ADSON Suction Tubes.....	226
ADSON-BROWN Dressing and Tissue Forceps	52
ADSON-DE BAKEY Dressing and Tissue Forceps	51
ALEXANDER Elevators.....	206
ALM Self-retaining Retractors	118
ANDERSON ADSON Cerebellar Retractor	126
Applying Forceps.....	81
Applying Forceps MCKENZIE	170
Applying Forceps OLIVECRONA-TOENNIS	170
Applying Forceps RANEY	172
Applying Forceps SMITHWICK	170
Applying Forceps SWEET	170
Atrauma Bulldog Clamps.....	77-79
Atrauma Bulldog Clamps DE BAKEY.....	79
Atrauma Bulldog Clamps DE BAKEY-HESS.....	80
Atrauma Bulldog Clamps GLOVER.....	79-80
Atrauma Micro Forceps DE BAKEY.....	66-67
Atraumatic Tissue Forceps DE BAKEY.....	68

B

BABINSKY Percussion Hammers	8
BABY-METZENBAUM BLACK	

Dissecting Scissors	25
BACON Bone Rongeurs.....	162
BANE-HARTMANN Bone Rongeurs.....	160
BARON Suction Tubes	226
BARRAQUER Micro Needle Holders.....	94
BAUMGARTNER Needle Holders.....	92
BECKMANN Laminectomy Retractors	130
BECKMANN-ADSON (CONE) ADSON Self-retaining Retractors.....	124
BECKMANN-ADSON Laminectomy Retractors	128
BECKMANN-EATON Laminectomy Retractors	130
BERLINER Percussion Hammers	8
BEYER Bone Rongeurs	161, 163
BIEMER Vein Scissors	44-45
BIEMER Vessel Spreader	244
Bipolar Coagulation	286-291
Bipolar connecting cables.....	293
Bipolar suction Forceps	292
BLACK Dissecting Scissors.....	25
Blade Breakers CASTROVIEJO.....	17
Blade Breakers REDA	17
Blade Breakers TROUTMAN-CHRIS ..	17
Blades for cervical Retractors....	142-143
Blunt hook LANDOLT	259
BÖHLER Bone Cutting Forceps.....	168
BÖHLER Bone Rongeurs.....	163
BOIES Elevator	207
Bone Curettes BRUNS	184
Bone Curettes BUSHE	187
Bone Curettes CASPAR	183
Bone Curettes COBB	181
Bone Curettes DAUBENSPECK	185
Bone Curettes HALLE	182
Bone Curettes JANSEN	188
Bone Curettes LEMPERT.....	186
Bone Curettes REDA	186-187
Bone Curettes SCOVILLE.....	183
Bone Curettes SPINAL.....	182
Bone Curettes SPRATT.....	180
Bone Curettes VOLKMANN	188
Bone Cutting Forceps.....	168-169
Bone Cutting Forceps BÖHLER	168
Bone Cutting Forceps COTTLE-KAZANJIAN	168
Bone Cutting Forceps LISTON.....	168
Bone Cutting Forceps MC INDOE	168
Bone Cutting Forceps RUSKIN-LISTON.....	168
Bone Cutting Forceps SEMB	169
Bone Cutting Forceps STAMM	168
Bone Cutting Forceps STILLE-HORSLEY	169
Bone Cutting Forceps STILLE-LISTON	169
Bone graft holder and impactor CASPAR	190
Bone Hammers and Mallets COTTLE	10
Bone Hammers and Mallets OMBREDANNE	10
Bone Hammers and Mallets WAGNER	10
Bone Hammers and Mallets WILLIGER	9
Bone Hand Drills.....	282
Bone Hand Drills BUNELL.....	283
Bone Hand Drills RALK	283
Bone Hand Drills REDA.....	284
Bone Rongeurs ADSON.....	159
Bone Rongeurs BACON.....	162
Bone Rongeurs BANE-HARTMANN	160
Bone Rongeurs BEYER	161, 163
Bone Rongeurs BÖHLER.....	163
Bone Rongeurs ECHLIN	167
Bone Rongeurs FRIEDMAN.....	158
Bone Rongeurs FRYKHOLM.....	167
Bone Rongeurs JANSEN.....	160
Bone Rongeurs KLEINERT-KUTZ.....	161
Bone Rongeurs LEKSELL (STILLE).....	166
Bone Rongeurs LEMPERT.....	160-161
Bone Rongeurs LUER	159
Bone Rongeurs MARQUARDT	164
Bone Rongeurs MAYFIELD.....	163
Bone Rongeurs MICRO FRIEDMAN.....	158
Bone Rongeurs OLIVECRONA	160
Bone Rongeurs RUSKIN.....	164
Bone Rongeurs SAUERBRUCH	166
Bone Rongeurs SEMB	167
Bone Rongeurs SMITH-PETERSEN.....	162
Bone Rongeurs STELLBRINK.....	158
Bone Rongeurs STILLE-LUER.....	165
Bone Rongeurs STILLE-RUSKIN.....	165
Bone Rongeurs ZAUFAL-JANSEN.....	163
Bore hole protection forceps.....	176
Brain Spatulas AACHEN	266
Brain Spatulas CUSHING.....	266

Brain Spatulas DAVIS.....	267
Brain Spatulas HEIFETZ.....	267
Brain Spatulas OLIVECRONA.....	266
BROPHY Dressing and Tissue Forceps.....	54
BROWN Micro Dressing and Tissue Forceps.....	53
BRUNS Bone Curettes.....	184
BUCK Percussion Hammers.....	8
Bulldog Clamps DIEFFENBACH.....	81
Bulldog Clamps DIETRICH Mini.....	76
Bulldog Clamps JOHNS-HOPKINS.....	81
BUNELL Bone Hand Drills.....	283
BUSHE Bone Curettes.....	187
Buttoned Probe JACOBSON.....	243
Buttoned probes RHOTON.....	250

C

CAPENER Lamina gouge.....	199
CAROLL Tendon grasping Forceps.....	89
CASPAR Bone Curettes.....	183
CASPAR Bone graft holder and impactor.....	190
CASPAR Cervical Vertebral Body Distraction System.....	154
CASPAR Exploration and Coagulation Hooks.....	113
CASPAR Hemostats.....	191
CASPAR Laminectomy Forceps.....	236-237
CASPAR Laminectomy Retractors.....	134
CASPAR Lumbar Retractors.....	150, 152
CASPAR Micro-Raspatories.....	223-224
CASPAR Nerve Root Retractors.....	110
CASPAR Scalpel Handles.....	16
CASPAR Specula for lumbar operations.....	151
CASPAR Suture Pusher.....	247
CASTROVIEJO Blade Breakers.....	17
CASTROVIEJO Micro Needle Holders.....	95
CASTROVIEJO Micro Scissors.....	36
Cerebellar Retractor ANDERSON ADSON.....	126
Cerebellar Retractor MISKIMON.....	126
Cervical Retractor CLOWARD.....	137-140
Cervical retractors.....	137-141
Cervical Traction Tongs CRUTCHFIELD.....	172
Cervical Vertebral Body Distraction System.....	154-155

Cervical Vertebral Body Distraction System CASPAR.....	154
Chisels LEXER.....	197
Chisels STILLE.....	192
CITELLI Punches.....	280
Clip Rack.....	170
CLOWARD Cervical Retractor.....	137-140
CLOWARD Lamina Retractor.....	147, 149
CLOWARD Laminectomy Forceps.....	233
CLOWARD Retractors.....	101
COBB Bone Curettes.....	181
COBB Gouge.....	196
COBB Raspatories.....	213
COLCLOUGH Intervertebral Disc Rongeurs.....	278
CONE Cranial Punch.....	175
CONE Ring Curettes.....	252
COTTLE Bone Hammers and Mallets.....	10
COTTLE Forceps.....	73
COTTLE Osteotome Rhinoplastic.....	200
COTTLE-KAZANJIAN Bone Cutting Forceps.....	168
Cranial Punch CONE.....	175
CRILE Hemostatic Forceps.....	83
CRILE Nerve Hooks.....	107
CRILE-RANKIN Hemostatic Forceps.....	83
CRILE-WOOD Needle Holders.....	92
CRUTCHFIELD Cervical Traction Tongs.....	172
Cup-shaped Forceps.....	264
Curette.....	254
Curette FAHLBUSCH.....	262
Curette LANDOLT.....	259
Curette NICOLA.....	257
Curettes VOLKMANN.....	180
CUSHING (LITTLE-JOKER) SEDILLOT Raspatories.....	203
CUSHING Brain Spatulas.....	266
CUSHING Dressing and Tissue Forceps.....	53
CUSHING Drill.....	282
CUSHING Dura Hooks.....	107
CUSHING Elevators.....	204
CUSHING Laminectomy Forceps.....	232
CUSHING Retractors.....	101
CUSHING-LANDOLT Pituitary Instruments.....	255
CUSHING-TAYLOR Dressing and Tissue Forceps.....	57

D

D'ERRICO Nerve Root Retractors.....	111
DANDY Dura Hooks.....	106
DANDY Hemostatic Forceps.....	84
DANDY Nerve Hooks.....	106
DANDY Neurosurgery scissors.....	33
DAUBENSPECK Bone Curettes.....	185
DAVIS Brain Spatulas.....	267
DAVIS Dura Dissector.....	217-218
DE BAKEY (POTTS-SMITH) Vascular Scissors.....	30
DE BAKEY Atrauma Bulldog Clamps.....	79
DE BAKEY Atrauma Micro Forceps.....	66-67
DE BAKEY Atraumatic Tissue Forceps.....	68
DE BAKEY Needle Holders.....	93
DE BAKEY Vascular Scissors.....	31-32
DE BAKEY-DIETRICH Mini Bulldog Clamps.....	76
DE BAKEY-HESS Atrauma Bulldog Clamps.....	80
DEAVER Operating Scissors.....	21
DECKER Laminectomy rongeurs.....	234
DEJERINE Percussion Hammers.....	8
Delicate Hook FISCH.....	243
Delicate Scissors.....	27
Delicate Scissors GRADLE.....	28
Delicate Scissors STEVENS.....	28
DEMARTEL saw conductor.....	173
DeVILBISS Skull Punches.....	174
DIEFFENBACH Bulldog Clamps.....	81
DIETRICH Mini Bulldog Clamps.....	76
DIETRICH Vascular Scissors.....	29-30
Dissecting and Ligature Forceps ADSON BABY.....	86
Dissecting and Ligature Forceps FUCHSIG.....	86
Dissecting and Ligature Forceps GEMINI.....	87
Dissecting and Ligature Forceps MIXTER BABY.....	88
Dissecting Scissors.....	22-27
Dissecting Scissors BABY-METZENBAUM BLACK.....	25
Dissecting Scissors BLACK.....	25
Dissecting Scissors JAMESON WERBER.....	26
Dissecting Scissors LEXER.....	22
Dissecting Scissors MAYO.....	22
Dissecting Scissors MAYO-STILLE.....	22

Dissecting Scissors METZENBAUM ...23	Drill HUDSON.....282	FAHLBUSCH Pituitary Curettes262	
Dissecting Scissors METZENBAUM BLACK.....24	Drill MC KENZIE.....282	FAHLBUSCH scoop262	
Dissecting Scissors METZENBAUM FINO.....23	DUEHRSEN Dressing and Tissue Forceps55	FARABEUF Raspatories202	
Dissecting Scissors Micro46	Dura Dissector DAVIS217-218	FARABEUF-COLLIN Raspatories202-203	
Dissecting Scissors REYNOLDS.....26	Dura Dissector FRAZIER219	FAVALORO Vascular Scissors32	
Dissecting Scissors YASARGIL41-42	Dura Dissector HOEN219	FERGUSSON Suction Tubes226-227	
Dissector GORNEY207	Dura Dissector HORSLEY.....218	FERRIS-SMITH Laminectomy Forceps.....235	
Dissector HARDY-FAHLBUSCH258	Dura Dissector MILLIGAN.....218	FERRIS-SMITH-KERRISON Intervertebral Disc Rongeurs.....274-275	
Dissector LANDOLT-REULEN.....262	Dura Dissector OLIVECRONA217	FERRIS-SMITH-KERRISON Intervertebral Disc Rongeurs dismantable276	
Dissector RHOTON250	Dura Dissector SACHS217	FERRIS-SMITH-KERRISON Intervertebral Disc Rongeurs dismantable black coated275, 277	
Dissectors PENFIELD220	Dura Dissector TOENNIS.....217	FISCH Delicate Hook243	
DOYEN Raspatories.....208-209	Dura Dissector WOODSON219	FISCH Dura Hook.....243	
Dressing and Tissue Forceps ADLERKREUTZ54	Dura Hook FISCH.....243	FISCH Micro Hooks.....115	
Dressing and Tissue Forceps ADSON.....51-52	Dura Hooks CUSHING107	FOMON Raspatories207	
Dressing and Tissue Forceps ADSON-BROWN.....52	Dura Hooks DANDY106	Forceps COTTLE73	
Dressing and Tissue Forceps ADSON-DE BAKEY.....51	Dura Scissors SCHMIEDEN-TAYLOR.....34	Forceps for grasping tissue HEIFETZ71	
Dressing and Tissue Forceps BROPHY54	E		
Dressing and Tissue Forceps CUSHING53	ECHLIN Bone Rongeurs167	Forceps for grasping tissue HUNT69-70	
Dressing and Tissue Forceps CUSHING-TAYLOR.....57	Elevator BOIES207	Forceps for grasping tissue SAMII72	
Dressing and Tissue Forceps DUEHRSEN55	Elevator FREER216	Forceps for grasping tissue YASARGIL.....69, 71	
Dressing and Tissue Forceps GERALD.....56-57	Elevator JOSEPH.....215	Forceps for grasping tissue YASARGIL-SAMII71	
Dressing and Tissue Forceps GILLIES.....56	Elevator MC DONALD.....215	Forceps JANSEN73	
Dressing and Tissue Forceps MAYO58	Elevator ROGER216	Forceps JANSEN-GRUENWALD.....73	
Dressing and Tissue Forceps McINDOE55	Elevator SEWALL.....215	Forceps LUCAE73	
Dressing and Tissue Forceps POTTS-SMITH50	Elevator WATSON-CHEYNE.....215	Fork spatula HOSOBUCHI.....259	
Dressing and Tissue Forceps SEMKEN56	Elevators.....211-216	FRAZIER Dura Dissector219	
Dressing and Tissue Forceps TAYLOR.....58	Elevators ALEXANDER.....206	FRAZIER Skin Hooks.....100	
Dressing and Tissue Forceps WANGENSTEEN58	Elevators CUSHING204	FRAZIER/FERGUSSON Suction Tubes.....227	
Dressing and Tissue Forceps WAUGH.....53	Elevators HOEN205	FREER Elevator216	
Drill CUSHING.....282	Elevators JANSEN202	FREER Skin Hooks.....100	
Drill ERRICO282	Elevators KEY214	FRIEDMAN Bone Rongeurs.....158	
Drill Guide and Dura Protecting Forceps ADSON.....177	Elevators KÖNIG.....206	FRIEDMAN Mini Bone Rongeurs.....158	
	Elevators LANGENBECK.....205	FRYKHOLM Bone Rongeurs.....167	
	Elevators QUERVAIN204	FUCHSIG Dissecting and Ligature Forceps.....86	
	Elevators SEBILEAU.....204		
	Elevators SEDILLOT204	G	
	Enucleator HARDY.....258	Galea Hook YASARGIL.....112	
	Enucleator LANDOLT.....259	GALT Skull Trepine.....177	
	ERRICO Drill282		
	Examination and Measuring Instruments.....11		
	Exploration and Coagulation Hooks CASPAR113		
	Extension piece282		
	F		
	FAHLBUSCH curette262		
	FAHLBUSCH Micro scissors263		

GELPI Retractor	146
GEMINI Dissecting and Ligature Forceps.....	87
GERALD Dressing and Tissue Forceps	56-57
GIERTZ-STILLE Rib Shears	48
GIGLI Handle saw	173
GIGLI STRULLY Handle saw	173
GILLIES Dressing and Tissue Forceps	56
GILLIES Skin Hooks.....	100
GLOVER Atrauma Bulldog Clamps	79-80
GORNEY Dissector	207
Gouge COBB.....	196
Gouges	192-193, 196-199
Gouges SMITH-PETERSEN	193
Gouges STILLE.....	192
Gouges ZIELKE.....	198
GRADLE Delicate Scissors	28
GRAHAM Nerve Hook.....	108
Grasping Forceps YASARGIL-NICOLA	263
GUILLEN Suction Raspatory.....	230

H

HAJEK-KOFLER Punches	279-280
HALLE Bone Curettes	182
HALSEY Needle Holders.....	92
HALSTED-MOSQUITO Hemostatic Forceps.....	82
HALSTED-MOSQUITO Micro Hemostatic Forceps	82
Handle saw GIGLI	173
Handle saw GIGLI STRULLY	173
Handle saw REDA.....	173
HARDY enucleator	258
HARDY Implantationsgabel implant fork	258
HARDY Pituitary Curettes	260
HARDY Pituitary Instruments	258, 261
HARDY-FAHLBUSCH dissector	258
HARTMANN Hemostatic Forceps	81
HARVEY-JACKSON Laminectomy Retractors.....	131
HEIFETZ Brain Spatulas	267
HEIFETZ Forceps for grasping tissue	71
Hemilaminectomy Retractor	144-145
Hemilaminectomy Retractor MARKHAM-MEYERDING	144

Hemilaminectomy Retractor MEYERDING	144
Hemostatic Forceps CRILE.....	83
Hemostatic Forceps CRILE-RANKIN	83
Hemostatic Forceps DANDY	84
Hemostatic Forceps HALSTED-MOSQUITO	82
Hemostatic Forceps HALSTED-MOSQUITO Micro	82
Hemostatic Forceps HARTMANN	81
Hemostatic Forceps KELLY.....	83
Hemostatic Forceps KELLY-RANKIN	83
Hemostatic Forceps Micro-HARTMANN	81
Hemostats CASPAR.....	191
HENLEY Self-retaining Retractors	121
HESS Nerve Root Retractors	109
HOEN Dura Dissector	219
HOEN Elevators	205
HOEN Laminectomy Forceps.....	234
HOLSHER Nerve Root Retractors	109
HOLZHEIMER Self-retaining Retractors	118
Hook RHOTON.....	250
HORSLEY Dura Dissector.....	218
HOSOBUCHI fork spatula	259
HOUSE Suction Tubes	229
HUDSON Drill.....	282
HUNT Forceps for grasping tissue	69-70
Hypophyseal Forceps ADSON	253
Implantationsgabel implant fork HARDY	258

I

INGE Lamina Retractor	148
Intervertebral Disc Rongeurs	274-278
Intervertebral Disc Rongeurs COLCLOUGH.....	278
Intervertebral Disc Rongeurs dismantable black coated FERRIS-SMITH-KERRISON	275, 277
Intervertebral Disc Rongeurs dismantable FERRIS-SMITH-KERRISON.....	276
Intervertebral Disc Rongeurs FERRIS-SMITH-KERRISON	274-275

J

JACOBSON Buttoned Probe.....	243
------------------------------	-----

JACOBSON Micro Scissors	44-45
JACOBSON Micro Vessel Knife	115
JACOBSON Suture Pusher.....	247
JACOBSON Twin Probe	243
JAMESON WERBER Dissecting Scissors	26
JANSEN Bone Curettes	188
JANSEN Bone Rongeurs	160
JANSEN Elevators	202
JANSEN Forceps	73
JANSEN Self-retaining Retractors.....	118
JANSEN-GRUENWALD Forceps	73
Jeweler Type Forceps	59-60
JOHNS-HOPKINS Bulldog Clamps.....	81
JOSEPH Elevator	215
JOSEPH Raspatories	207
JOSEPH Skin Hooks	100

K

KELLY Hemostatic Forceps.....	83
KELLY Operating Scissors	21
KELLY-RANKIN Hemostatic Forceps	83
KERRISON Punches.....	279
KEY Elevators	214
KILNER Dissecting Scissors	26
KLEINERT-KUTZ Bone Rongeurs.....	161
KNIGHTON Laminectomy Retractors	132
Knives for tumor tissue SAMII	245-246
Knives KOOS	243
KOCHER Retractors.....	103
KOCHER-LANGENBECK Retractors	102
KÖNIG Elevators	206
KOOS Knives	243
KOOS Micro Vessel Knives	242
KRAYENBÜHL Nerve- and Vessel Hooks	114

L

LAMBOTTE Osteotomes.....	194
LAMBOTTE Raspatories	203
Lamina gouge CAPENER	199
Lamina Retractor CLOWARD.....	147, 149
Lamina Retractor INGE	148
Laminectomy Forceps	232-238
Laminectomy Forceps CASPAR	236-237
Laminectomy Forceps CLOWARD	233
Laminectomy Forceps CUSHING.....	232

Laminectomy Forceps		LEXER Dissecting Scissors.....	22	Micro Forceps YASARGIL	74
FERRIS-SMITH	235	LEXER MINI Chisels	197	MICRO FRIEDMAN	
Laminectomy Forceps HOEN.....	234	LEXER MINI Osteotomes	197	Bone Rongeurs.....	158
Laminectomy Forceps		LEXER Osteotomes	197	Micro Hooks FISCH	115
LOVE-GRUENWALD	232	LEYLA Retractor System.....	268-272	Micro Needle Holders	94-98
Laminectomy Forceps		Ligature Guides YASARGIL	114	Micro Needle Holders	
SCHLESINGER.....	233	LISTON Bone Cutting Forceps.....	168	BARRAQUER.....	94
Laminectomy Forceps SPURLING.....	232	LOVE Nerve Root Retractors	111-112	Micro Needle Holders	
Laminectomy Forceps WAGNER.....	235	LOVE-GRUENWALD		CASTROVIEJO	95
Laminectomy Forceps		Laminectomy Forceps	232	Micro Needle Holders	
WEIL-BLAKESLEY	238	LUCAE Forceps.....	73	YASARGIL.....	96
Laminectomy Retractors.....	127-137	LUER Bone Rongeurs	159	Micro Ring Forceps	65
Laminectomy Retractors ADSON	127	Lumbal Retractors	152-153	Micro Scissors	35-46, 266
Laminectomy Retractors		Lumbal Retractors CASPAR	150, 152	Micro Scissors CASTROVIEJO.....	36
BECKMANN-ADSON	128			Micro Scissors FAHLBUSCH.....	263
Laminectomy Retractors				Micro Scissors JACOBSON	44-45
BECKMANN-EATON	130			Micro Scissors MILLESI	44-45
Laminectomy Retractors CASPAR	134			Micro Scissors NAGEL	43
Laminectomy Retractors				Micro Scissors NICOLA.....	263
HARVEY-JACKSON	131			Micro Scissors	
Laminectomy Retractors				POTTS-YASARGIL	44-45
KNIGHTON	132			Micro Scissors VANNAS	37, 42, 44-45
Laminectomy Retractors				Micro Scissors YASARGIL	41-42, 44
SCOVILLE	135			Micro Scoops.....	189
Laminectomy Retractors				Micro Scoops YASARGIL.....	189
SCOVILLE-HAVERFIELD	135			Micro suction cannula.....	230
Laminectomy Retractors				Micro Suture Tying Forceps.....	61-63
SCOVILLE-RICHTER	136			Micro Suture Tying	
Laminectomy Retractors TAYLOR	135			Forceps LAZAR.....	62
Laminectomy Retractors WALTON	133			Micro Vessel Clips ACLAND.....	297
Lancet knives SAMII.....	246			Micro Vessel Knife JACOBSON	115
LANDOLT blunt hook.....	259			Micro Vessel Knives KOOS	242
LANDOLT curette	259			Micro Vessel Knives YASARGIL.....	242
LANDOLT enucleator	259			Micro-HARTMANN	
LANDOLT Pituitary forceps	239			Hemostatic Forceps.....	81
LANDOLT Pituitary				Micro-Raspatories	221-222
Instruments.....	256, 259			Micro-Raspatories CASPAR.....	223-224
LANDOLT Scalpel Handles	16			Micro-Raspatories YASARGIL.....	221-223
LANDOLT scoop.....	259			MILLESII Micro Scissors	44-45
LANDOLT spreader for specula	255			MILLIGAN Dura Dissector.....	218
LANDOLT Tumor Grasping Forceps.....	239			MILLS Vascular Scissors	29
LANDOLT-REULEN dissector	262			Mini Bone Rongeurs FRIEDMAN	158
LANDOLT-REULEN				Mini Bulldog Clamps	
Pituitary Curettes	262			DE BAKEY-DIETHRICH.....	76
LANDOLT-REULEN raspatories.....	262			MINI Chisels LEXER	197
LANGENBECK Elevators	205			MINI-LAMBOTTE Osteotomes	195
LANGENBECK Retractors	103			MISKIMON Cerebellar Retractor.....	126
LAZAR Micro Suture Tying Forceps.....	62			MIXTER BABY Dissecting	
LEKSELL (STILLE) Bone Rongeurs.....	166			and Ligature Forceps.....	88
LEMPERT Bone Curettes.....	186			MOLLISON Self-retaining	
LEMPERT Bone Rongeurs.....	160-161			Retractors	120
LEXER Chisels	197			MOLT Raspatories.....	206

M

MARKHAM-MEYERDING

Hemilaminectomy Retractor	144
MARQUARDT Bone Rongeurs	164
MARTEL Scalp Flap Forceps	85
MATSON Raspatories	210
MATSON-ALEXANDER	
Raspatories	210
MAYFIELD Bone Rongeurs.....	163
MAYO Dissecting Scissors.....	22
MAYO Dressing and Tissue Forceps.....	58
MAYO-ADAMS Self-retaining	
Retractors	122
MAYO-HEGAR Needle Holders	93
MAYO-STILLE Dissecting Scissors.....	22
MC DONALD Elevator.....	215
MC INDOE Bone Cutting Forceps.....	168
MC KENZIE Drill.....	282
McINDOE Dressing and	
Tissue Forceps	55
McKENZIE Applying Forceps	170
METZENBAUM BLACK	
Dissecting Scissors	24
METZENBAUM Dissecting Scissors.....	23
METZENBAUM FINO	
Dissecting Scissors	23
MEYERDING Hemilaminectomy	
Retractor.....	144
MEYERDING Retractors	104
MICHELE Trephine.....	178
Micro dissecting Scissors	46
Micro Dressing and Tissue	
Forceps ADSON	51-52
Micro Dressing and Tissue	
Forceps BROWN.....	53
Micro forceps.....	264

K

NAGEL Micro Scissors	43
Needle Holders BAUMGARTNER	92
Needle Holders CRILE-WOOD	92
Needle Holders DE BAKEY	93
Needle Holders HALSEY	92
Needle Holders MAYO-HEGAR	93
Needle Holders Micro	94-98
Needle Holders NEIVERT	92
Needle Holders RYDER	93
NEIVERT Needle Holders	92
Nerve Dissecting Scissors	
TOENNIS-ADSON	27
Nerve Hook ADSON	108
Nerve Hook GRAHAM	108
Nerve Hook SACHS	108
Nerve Hook SMITHWICK	108
Nerve Hooks CRILE	107
Nerve Hooks DANDY	106
Nerve Root Retractors CASPAR	110
Nerve Root Retractors D'ERRICO	111
Nerve Root Retractors HESS	109
Nerve Root Retractors HOLSHER	109
Nerve Root Retractors LOVE	111-112
Nerve Root Retractors	
SCOVILLE	109, 112
Nerve- and Vessel Hooks	
KRAYENBÜHL	114
Neurosurgery scissors DANDY	33
Neurosurgery scissors STRULLY	33
NICOLA curette	257
NICOLA Micro Scissors	263
NICOLA Pituitary Instruments	257
NICOLA Raspatory	257
NORFOLK-NORWICH	
Self-retaining Retractors	122

K

OKONEK-YASARGIL Tumor Forks	248
OLDBERG Pituitary forceps	239
OLIVECRONA Bone Rongeurs	160
OLIVECRONA Brain Spatulas	266
OLIVECRONA Dura Dissector	217
OLIVECRONA Trigeminal Scissors	33
OLIVECRONA Wire saw	173
OLIVECRONA-TOENNIS	
Applying Forceps	170
OMBREDANNE Bone Hammers	
and Mallets	10
Operating Scissors	20-21
Operating Scissors DEAVER	21

Operating Scissors KELLY	21
Operating Scissors STANDARD	20
Osteotome Rhinoplastic	200
Osteotome Rhinoplastic COTTLE	200
Osteotomes LAMBOTTE	194
Osteotomes LEXER	197
Osteotomes LEXER MINI	197
Osteotomes MINI-LAMBOTTE	195
Osteotomes STILLE	192

P

PAPAVERO-CASPAR Pituitary	
Instruments	256
PAPAVERO-HARTMANN	
Pituitary Instruments	256
PENFIELD Dissectors	220
Percussion Hammers BABINSKY	8
Percussion Hammers BERLINER	8
Percussion Hammers BUCK	8
Percussion Hammers DEJERINE	8
Percussion Hammers	
TAYLOR USA Mod	8
Percussion Hammers TROEMNER	8
Pin wheel WARTENBERG	11
Pituitary Curettes FAHLBUSCH	262
Pituitary Curettes HARDY	260
Pituitary Curettes	
LANDOLT-REULEN	262
Pituitary forceps LANDOLT	239
Pituitary forceps OLDBERG	239
Pituitary forceps YASARGIL	239
Pituitary Instruments	255-264
Pituitary Instruments	
CUSHING-LANDOLT	255
Pituitary Instruments HARDY	258, 261
Pituitary Instruments	
LANDOLT	256, 259
Pituitary Instruments NICOLA	257
Pituitary Instruments	
PAPAVERO-CASPAR	256
Pituitary Instruments	
PAPAVERO-HARTMANN	256
PLESTER Self-retaining	
Retractors	120, 122
PLESTER Suction Tubes	229
POTTS-DE MARTEL	
Vascular Scissors	29
POTTS-SMITH Dressing	
and Tissue Forceps	50
POTTS-SMITH	
Vascular Scissors	30-31

POTTS-YASARGIL	
Micro Scissors	44-45
Punches	279-280
Punches CITELLI	280
Punches HAJEK-KOFLER	279-280
Punches KERRISON	279

Q

QUERVAIN Elevators	204
--------------------------	-----

R

RALK Bone Hand Drills	283
RANEY Applying Forceps	172
Raspatories ADSON	214
Raspatories COBB	213
Raspatories CUSHING	
(LITTLE-JOKER) SEDILLOT	203
Raspatories DOYEN	208-209
Raspatories FARABEUF	202
Raspatories	
FARABEUF-COLLIN	202-203
Raspatories FOMON	207
Raspatories JOSEPH	207
Raspatories LAMBOTTE	203
Raspatories LANDOLT-REULEN	262
Raspatories MATSON	210
Raspatories	
MATSON-ALEXANDER	210
Raspatories MOLT	206
Raspatories RHOTON	250
Raspatories SEDILLOT	203
Raspatories SELDIN	207
Raspatories WAGNER	213
Raspatories WILLIGER	206
Raspatory NICOLA	257
REDA Blade Breakers	17
REDA Bone Curettes	186-187
REDA Bone Hand Drills	283
REDA Handle saw	173
Retractor GELPI	146
Retractor System LEYLA	268-272
Retractor System YASARGIL	268-272
Retractor WILLIAMS	145
Retractors Laminectomy	
BECKMANN	130
Retractors Cervical	137-141
Retractors CLOWARD	101
Retractors CUSHING	101
Retractors Hemilaminectomy	144-145
Retractors KOCHER	103

Retractors	
KOCHER-LANGENBECK	102
Retractors LANGENBECK	103
Retractors MEYERDING	104
REYNOLDS Dissecting Scissors.....	26
Rhinoplastic Osteotome	200
RHOTON Buttoned probes.....	250
RHOTON Dissector	250
RHOTON Hook.....	250
RHOTON Raspatories.....	250
RHOTON spatula	250
Rib Shears GIERTZ-STILLE	48
Rib Shears SAUERBRUCH.....	48
Rib Shears SAUERBRUCH-FREY.....	48
Ring Curettes CONE	252
Ring Forceps Micro	65
ROGER Elevator	216
RUSKIN Bone Rongeurs.....	164
RUSKIN-LISTON Bone Cutting Forceps	168
RYDER Needle Holders	93

S

SACHS Dura Dissector	217
SACHS Nerve Hook	108
SAMII Forceps for grasping tissue	72
SAMII Knives for tumor tissue	245-246
SAMII Lancet knives.....	246
SAUERBRUCH Bone Rongeurs	166
SAUERBRUCH Rib Shears.....	48
SAUERBRUCH-FREY Rib Shears.....	48
Saw conductor DEMARTEL	173
Scalp Flap Forceps MARTEL	85
Scalp Retractor SCALP-CONTOUR.....	125
SCALP-CONTOUR Scalp Retractor.....	125
Scalpel Handles.....	14-16
Scalpel Handles CASPAR	16
Scalpel Handles LANDOLT	16
SCHLESINGER Laminectomy Forceps	233
SCHMIEDEN-TAYLOR Dura Scissors	34
Scissors Delicate	27
Scissors KILNER Dissecting	26
Scissors Operating	20-21
Scissors, Micro	35-46, 266
Scoop FAHLBUSCH.....	262
Scoop LANDOLT	259
SCOVILLE Bone Curettes	183
SCOVILLE Laminectomy Retractors.....	135

SCOVILLE Nerve Root Retractors	109, 112
SCOVILLE-HAVERFIELD Laminectomy Retractors.....	135
SCOVILLE-RICHTER Laminectomy Retractors.....	136
SEBILEAU Elevators	204
SEDILLOT Elevators	204
SEDILLOT Raspatories	203
SELDIN Raspatories	207
Self-retaining Retractors ADSON	123-124
Self-retaining Retractors ALM	118
Self-retaining Retractors BECKMANN -ADSON (CONE)	124
Self-retaining Retractors HENLEY	121
Self-retaining Retractors HOLZHEIMER	118
Self-retaining Retractors JANSEN	118
Self-retaining Retractors MAYO-ADAMS	122
Self-retaining Retractors MOLLISON	120
Self-retaining Retractors NORFOLK-NORWICH	122
Self-retaining Retractors PLESTER	120, 122
Self-retaining Retractors TRAVERS	123
Self-retaining Retractors WEITLANER	119
Self-retaining Retractors WEITLANER-WULLSTEIN.....	119
Self-retaining Retractors WULLSTEIN	120
SEMB Bone Cutting Forceps.....	169
SEMB Bone Rongeurs	167
SEMKEN Dressing and Tissue Forceps	56
SEWALL Elevator	215
Skin Hooks FRAZIER.....	100
Skin Hooks FREER.....	100
Skin Hooks GILLIES.....	100
Skin Hooks JOSEPH.....	100
Skull Punches DeVILBISS.....	174
Skull Trephine GALT	177
SMITH-PETERSEN Bone Rongeurs.....	162
SMITH-PETERSEN Gouges	193
SMITHWICK Applying Forceps	170
SMITHWICK Nerve Hook.....	108
Spatula RHOTON.....	250

Specula for lumbal operations CASPAR	151
SPINAL Bone Curettes.....	182
Spinal retractors TAYLOR.....	105
SPRATT Bone Curettes.....	180
Spreader for specula LANDOLT	255
SPURLING Laminectomy Forceps.....	232
STAMM Bone Cutting Forceps	168
STANDARD Operating Scissors.....	20
STELLBRINK Bone Rongeurs.....	158
STEVENS Delicate Scissors	28
STILLE Chisels.....	192
STILLE Gouges.....	192
STILLE Osteotomes	192
STILLE-HORSLEY Bone Cutting Forceps	169
STILLE-LISTON Bone Cutting Forceps	169
STILLE-LUER Bone Rongeurs.....	165
STILLE-RUSKIN Bone Rongeurs.....	165
STRULLY Neurosurgery scissors.....	33
Suction Raspatory GUILLEN.....	230
Suction Tubes.....	226-230
Suction Tubes ADSON	226
Suction Tubes BARON	226
Suction Tubes FERGUSSON.....	226-227
Suction Tubes FRAZIER/FERGUSSON	227
Suction Tubes HOUSE	229
Suction Tubes PLESTER	229
Suction Tubes WULLSTEIN	230
Suction Tubes YASARGIL	228
Suction Tubes ZÖLLNER	228
Suture Pusher CASPAR	247
Suture Pusher JACOBSON.....	247
Suture Tying Forceps Micro.....	61-63
SWEET Applying Forceps	170

T

TAYLOR Dressing and Tissue Forceps	58
TAYLOR Laminectomy Retractors.....	135
TAYLOR Spinal retractors	105
TAYLOR USA Mod Percussion Hammers.....	8
Tendon grasping Forceps CAROLL	89
Tissue Pick	249
TOENNIS Dura Dissector	217
TOENNIS-ADSON Nerve Dissecting Scissors	27
TRAVERS Self-retaining Retractors.....	123

Trephine MICHELE	180
Trigeminal Scissors OLIVECRONA	33
TROEMNER Percussion Hammers.....	8
TROUTMAN-CHRIS Blade Breakers ..	17
Tumor Forks OKONEK-YASARGIL ..	248
Tumor Forks YASARGIL.....	248
Tumor Grasping	
Forceps LANDOLT	239
Tumor scissors	47
Tuning Fork	11
Twin Probe JACOBSON.....	243

U

Ultra-Light-Forceps.....	64
UNIVERSAL Wire and plate scissors ..	34

V

VANNAS Micro Scissors....	37, 42, 44-45
Vascular Scissors	29-32
Vascular Scissors DE BAKEY	31-32
Vascular Scissors	
DE BAKEY (POTTS-SMITH).....	30
Vascular Scissors DIETRICH	29-30
Vascular Scissors FAVALORO	32
Vascular Scissors MILLS.....	29
Vascular Scissors	
POTTS-DE MARTEL.....	29
Vascular Scissors	
POTTS-SMITH	30-31
Vein Scissors BIEMER	44-45
Vertebral Body	
Distraction System.....	156
Vessel dilators	60
Vessel Spreader BIEMER	244
VOLKMANN Bone Curettes	188
VOLKMANN Curettes.....	180

W

WAGNER Bone Hammers	
and Mallets	10
WAGNER Laminectomy Forceps	235
WAGNER Raspatories	213
WALTON Laminectomy Retractors....	133
WANGENSTEEN Dressing	
and Tissue Forceps	58
WARTENBERG Pin wheel	11
WATSON-CHEYNE Elevator.....	215
WAUGH Dressing and	
Tissue Forceps	53
WEIL-BLAKESLEY	
Laminectomy Forceps	238

WEITLANER Self-retaining	
Retractors	119
WEITLANER-WULLSTEIN	
Self-retaining Retractors.....	119
WILLIAMS Retractor.....	145
WILLIGER Bone Hammers	
and Mallets	9
WILLIGER Raspatories	206
Wire and plate scissors,	
UNIVERSAL	34
Wire saw OLIVECRONA	173
WOODSON Dura Dissector	219
WULLSTEIN Self-retaining	
Retractors	120
WULLSTEIN Suction Tubes	230

Y

YASARGIL Dissecting Scissors.....	41-42
YASARGIL Forceps	
for grasping tissue	69, 71
YASARGIL Galea Hook.....	112
YASARGIL Ligature Guides.....	114
YASARGIL Micro Forceps	74
YASARGIL Micro Needle Holders	96
YASARGIL Micro Scissors.....	41-42, 44
YASARGIL Micro Scoops	189
YASARGIL Micro Vessel Knives.....	242
YASARGIL Micro-Raspatories... ..	221-223
YASARGIL Pituitary forceps	239
YASARGIL Retractor System ...	268-272
YASARGIL Suction Tubes	228
YASARGIL Tumor Forks.....	248
YASARGIL-NICOLA	
Grasping Forceps	263
YASARGIL-SAMII Forceps	
for grasping tissue	71

Z

ZAUFAL-JANSEN Bone Rongeurs....	163
ZIELKE Gouges.....	198
ZÖLLNER Suction Tubes	228

A

AACHEN Espátulas cerebrales	266
ACLAND Micro Clips vasculares	296
ADLERKREUTZ Pinzas de disección sin/con dientes.....	54
ADSON BABY Pinzas para preparaciones y para ligaduras	86
ADSON Ganchos para nervios.....	108
ADSON Micro Pinzas de disección sin/con dientes.....	51-52
ADSON Periostótomos.....	214
ADSON Pinza guía taladros y protectora de duramadre	177
ADSON Pinzas de disección sin/con dientes.....	51-52
ADSON Pinzas para hipófisis.....	253
ADSON Pinzas-gubias	159
ADSON Separadores autoestáticos	123-124
ADSON Separadores para laminectomía	127
ADSON Tubos de aspiración.....	226
ADSON-BROWN Pinzas de disección sin/con dientes.....	52
ADSON-DE BAKEY Pinzas de disección sin/con dientes.....	51
ALEXANDER Elevadores.....	206
ALM Separadores autoestáticos	118
ANDERSON ADSON Separador para cerebelo.....	126

B

BABINSKY Martillos de percusión.....	8
BABY-METZENBAUM BLACK Tijeras de disección	25
BACON Pinzas-gubias	162
BANE-HARTMANN Pinzas-gubias.....	160
BARON Tubos de aspiración.....	226
BARRAQUER Micro-porta-agujas.....	94
BAUMGARTNER Porta-agujas	92
BECKMANN Separadores para laminectomía	130
BECKMANN-ADSON (CONE) ADSON Separadores autoestáticos.....	124
BECKMANN-ADSON Separadores para laminectomía	128
BECKMANN-EATON Separadores para laminectomía	130
BERLINER Martillos de percusión.....	8
BEYER Pinzas-gubias.....	161, 163
BIEMER Separador para vasos	244

BIEMER Tijera para venas	44-45
Bisturíes KOOS	243
BLACK Tijeras de disección	25
BÖHLER Pinzas cortantes para huesos.....	168
BÖHLER Pinzas-gubias	163
BOIES Elevador	207
Broca CUSHING	282
Broca ERRICO	282
Broca MC KENZIE	282
BROPHY Pinzas de disección sin/con dientes.....	54
BROWN Micro Pinzas de disección sin/con dientes.....	53
BRUNS Cucharillas cortantes	184
BUCK Martillos de percusión.....	8
BUNELL Perforadores de mano.....	283
BUSHE Cucharillas cortantes.....	187

C

Cables de conexión bipolares	293
CAPENER Gubias para la columna vertebral	199
CAROLL Pinza para agarrar tendones	89
CASPAR Cervical Sistema de distracción vertebral	154
CASPAR Cucharillas cortantes	183
CASPAR Empujadores de suturas	247
CASPAR Especulas para operaciones lumbales.....	151
CASPAR Ganchos para exploración y coagulación	113
CASPAR Hemostáticos	191
CASPAR Injerto óseo titular y impactador	190
CASPAR Legras para micro-cirugía	223-224
CASPAR Mangos de bisturíes.....	16
CASPAR Pinzas para laminectomía	236-237
CASPAR Separadores de raíz de nervios	110
CASPAR Separadores lumbales autoestáticos	150, 152
CASPAR Separadores para laminectomía	134
CASTROVIEJO Micro tijeras.....	36
CASTROVIEJO Micro-porta-agujas	95
CASTROVIEJO Rompe-hojas.....	17
Cervical Sistema de	

distracción vertebral	154-155
Cervical Sistema de distracción vertebral CASPAR.....	154
Cervicales Retractores	137-141
Cinceles LEXER	197
Cinceles LEXER MINI	197
Cinceles STILLE.....	192
CITELLI Pinzas.....	280
Clamps Atrauma Bulldog	77-79
Clamps Atrauma Bulldog DE BAKEY.....	79
Clamps Atrauma Bulldog DE BAKEY-HESS.....	80
Clamps Atrauma Bulldog GLOVER.....	79-80
Clamps Bulldog Mini DE BAKEY-DIETHRICH.....	76
Clamps Bulldog Mini DIETHRICH	76
CLOWARD Pinzas para laminectomía	233
CLOWARD Separador cervical ..	137-140
CLOWARD Separadores	101
CLOWARD Separadores para vertebrales.....	147, 149
Coagulación bipolar.....	286-291
COBB Cucharillas cortantes.....	181
COBB gubia.....	196
COBB Periostótomos	213
COLCLOUGH Pinzas sacabocado para discos intervertebrales.....	278
CONE Curetas anulares.....	252
CONE Pinzas sacabocado craneal ..	175
Cortantes VOLKMANN.....	180
Costótomos GIERTZ-STILLE	48
Costótomos SAUERBRUCH	48
Costótomos SAUERBRUCH-FREY ..	48
COTTLE Martillos y mazos.....	10
COTTLE Osteotomos para la plástica nasal	200
COTTLE Pinzas.....	73
COTTLE-KAZANJIAN Pinzas cortantes para huesos	168
CRILE Ganchos para nervios.....	107
CRILE Pinzas hemostáticas	83
CRILE-RANKIN Pinzas hemostáticas	83
CRILE-WOOD Porta-agujas.....	92
CRUTCHFIELD Pinzas de tracción craneal	172
Cucharilla FAHLBUSCH.....	262
Cucharilla LANDOLT	259
Cucharillas cortantes BRUNS	184

Cucharillas cortantes BUSHE.....	187
Cucharillas cortantes CASPAR.....	183
Cucharillas cortantes COBB.....	181
Cucharillas cortantes	
DAUBENSPECK.....	185
Cucharillas cortantes HALLE.....	182
Cucharillas cortantes JANSEN.....	188
Cucharillas cortantes LEMPERS.....	186
Cucharillas cortantes REDA.....	186-187
Cucharillas cortantes SCOVILLE.....	183
Cucharillas cortantes SPINAL.....	182
Cucharillas cortantes SPRATT.....	180
Cucharillas cortantes VOLKMAN.....	188
Cuchillo lanceolar SAMII.....	246
Cuchillos para tumores SAMII... ..	245-246
Cureta.....	254
Cureta FAHLBUSCH.....	262
Cureta LANDOLT.....	259
Cureta NICOLA.....	257
Cureta para hipófisis FAHLBUSCH... ..	262
Cureta para hipófisis HARDY.....	260
Cureta para hipófisis	
LANDOLT-REULEN.....	262
Curetas anulares CONE.....	252
CUSHING (LITTLE-JOKER)	
SEDILLOT Periostótomos.....	203
CUSHING broca.....	282
CUSHING Elevadores.....	204
CUSHING Espátulas cerebrales.....	266
CUSHING Para dura-madre.....	107
CUSHING Pinzas de disección	
sin/con dientes.....	53
CUSHING Pinzas	
para laminectomía.....	232
CUSHING Separadores.....	101
CUSHING-LANDOLT	
Instrumentos para hipófisis.....	255
CUSHING-TAYLOR Pinzas	
de disección sin/con dientes.....	57

D

D'ERRICO Separadores	
de raíz de nervios.....	111
DANDY Ganchos para nervios.....	106
DANDY Para dura-madre.....	106
DANDY Pinzas hemostáticas.....	84
DANDY tijera para neurocirugía.....	33
DAUBENSPECK	
Cucharillas cortantes.....	185
DAVIS Disector para	
duramadre.....	217-218

DAVIS Espátulas cerebrales.....	267
DE BAKEY (POTTS-SMITH)	
Tijeras vasculares.....	30
DE BAKEY Clamps Atrauma Bulldog..	79
DE BAKEY Micro	
Pinzas Atraumáticas.....	66-67
DE BAKEY Pinzas Atraumáticas.....	68
DE BAKEY Porta-agujas.....	93
DE BAKEY Tijeras vasculares.....	31-32
DE BAKEY-DIETHRICH	
Clamps Bulldog Mini.....	76
DE BAKEY-HESS	
Clamps Atrauma Bulldog.....	80
DEAVER Tijeras para cirugía.....	21
DECKER Pinzas para	
laminectomía.....	234
DEJERINE Martillos de percusión.....	8
DeMARTEL guía-conductora.....	173
DeVILBISS Pinzas	
sacabocado craneal.....	174
Diapasón.....	11
DIEFFENBACH Pinzas serra-finas.....	81
DIETHRICH Clamps Bulldog Mini.....	76
DIETRICH Tijeras vasculares.....	29-30
Dilatadores vasculares.....	60
Disector GORNEY.....	207
Disector HARDY-FAHLBUSCH.....	258
Disector LANDOLT-REULEN.....	262
Disector para	
duramadre DAVIS.....	217-218
Disector para	
duramadre FRAZIER.....	219
Disector para	
duramadre HOEN.....	219
Disector para	
duramadre HORSLEY.....	218
Disector para	
duramadre MILLIGAN.....	218
Disector para	
duramadre OLIVECRONA.....	217
Disector para	
duramadre SACHS.....	217
Disector para	
duramadre TOENNIS.....	217
Disector para	
duramadre WOODSON.....	219
Disector RHOTON.....	250
Disectores PENFIELD.....	220
DOYEN Periostótomos.....	208-209
DUEHRSEN Pinzas	
de disección sin/con dientes.....	55

E

ECHLIN Pinzas-gubias.....	167
Elevador BOIES.....	207
Elevador FREER.....	216
Elevador JOSEPH.....	215
Elevador MC DONALD.....	215
Elevador ROGER.....	216
Elevador SEWALL.....	215
Elevador WATSON-CHEYNE.....	215
Elevadores.....	211-216
Elevadores ALEXANDER.....	206
Elevadores CUSHING.....	204
Elevadores HOEN.....	205
Elevadores JANSEN.....	202
Elevadores KEY.....	214
Elevadores KÖNIG.....	206
Elevadores LANGENBECK.....	205
Elevadores QUERVAIN.....	204
Elevadores SEBILEAU.....	204
Elevadores SEDILLOT.....	204
Empujadores de	
suturas CASPAR.....	247
Empujadores de	
suturas JACOBSON.....	247
Enucleador HARDY.....	258
Enucleador LANDOLT.....	259
ERRICO broca.....	282
Esonda abotonada RHOTON.....	250
Espatula forma horquilla	
HOSOBUCHI.....	259
Espatulado RHOTON.....	250
Espátulas cerebrales AACHEN.....	266
Espátulas cerebrales CUSHING.....	266
Espátulas cerebrales DAVIS.....	267
Espátulas cerebrales HEIFETZ.....	267
Espátulas cerebrales	
OLIVECRONA.....	266
Especulas para	
operaciones lumbales CASPAR.....	151

F

FAHLBUSCH cucharilla.....	262
FAHLBUSCH cureta.....	262
FAHLBUSCH Cureta para hipófisis... ..	262
FAHLBUSCH Micro-tijera.....	263
FARABEUF Periostótomos.....	202
FARABEUF-COLLIN	
Periostótomos.....	202-203
FAVALORO Tijeras vasculares.....	32
FERGUSON Tubos de	
aspiración.....	226-227

FERRIS-SMITH Pinzas para laminectomía.....	235
FERRIS-SMITH-KERRISON Pinzas sacabocado para discos intervertebrales.....	274-275
FERRIS-SMITH-KERRISON Pinzas sacabocado para discos intervertebrales desmontable.....	276
FERRIS-SMITH-KERRISON Pinzas sacabocado para discos intervertebrales desmontable recubrimiento negro.....	275, 277
Finas Tijeras.....	27
FISCH Ganchito muy fino.....	243
FISCH Ganchito para dura-madre.....	243
FISCH Micro-ganchitos.....	115
FOMON Periostótomos.....	207
FRAZIER Disector para duramadre.....	219
FRAZIER Ganchos para la piel.....	100
FRAZIER/FERGUSSON Tubos de aspiración.....	227
FREER Elevador.....	216
FREER Ganchos para la piel.....	100
FRIEDMAN Mini Pinzas-gubias.....	158
FRIEDMAN Pinzas-gubias.....	158
FRYKHOLM Pinzas-gubias.....	167
FUCHSIG Pinzas para preparaciones y para ligaduras.....	86

G

GALT Trépanos craneales.....	177
Ganchito muy fino FISCH.....	243
Ganchito para dura-madre FISCH.....	243
Gancho LANDOLT.....	259
Gancho para galea YASARGIL.....	112
Gancho RHOTON.....	250
Ganchos para exploración y coagulación CASPAR.....	113
Ganchos para la piel FRAZIER.....	100
Ganchos para la piel FREER.....	100
Ganchos para la piel GILLIES.....	100
Ganchos para la piel JOSEPH.....	100
Ganchos para nervios ADSON.....	108
Ganchos para nervios CRILE.....	107
Ganchos para nervios DANDY.....	106
Ganchos para nervios GRAHAM.....	108
Ganchos para nervios SACHS.....	108
Ganchos para nervios SMITHWICK.....	108
Ganchos para nervios y vasos KRAYENBÜHL.....	114
Garra para tejido.....	249

GELPI Separadores.....	146
GEMINI Pinzas para preparaciones y para ligaduras.....	87
GERALD Pinzas de disección sin/con dientes.....	56-57
GIERTZ-STILLE Costótomos.....	48
GIGLI mango para sierra.....	173
GIGLI STRULLY mango para sierra.....	173
GILLIES Ganchos para la piel.....	100
GILLIES Pinzas de disección sin/con dientes.....	56
GLOVER Clamps.....	
Atrauma Bulldog.....	79-80
GORNEY Disector.....	207
GRADLE Tijeras finas.....	28
GRAHAM Ganchos para nervios.....	108
Gubia COBB.....	196
Gubias.....	192-193, 196-199
Gubias para la columna vertebral CAPENER.....	199
Gubias SMITH-PETERSEN.....	193
Gubias STILLE.....	192
Gubias ZIELKE.....	198
Guia para ligaduras YASARGIL.....	114
guia-conductora DeMARTEL.....	173
GUILLEN Legra de succión.....	230

H

HAJEK-KOFLER Pinzas.....	279-280
HALLE Cucharillas cortantes.....	182
HALSEY Porta-agujas.....	92
HALSTED-MOSQUITO Micro Pinzas hemostáticas.....	82
HALSTED-MOSQUITO Pinzas hemostáticas.....	82
HARDY Cureta para hipófisis.....	260
HARDY enucleador.....	258
HARDY horquilla de implante.....	258
HARDY Instrumentos para hipófisis.....	258, 261
HARDY-FAHLBUSCH disector.....	258
HARTMANN Pinzas hemostáticas.....	81
HARVEY-JACKSON Separadores para laminectomía.....	131
HEIFETZ Espátulas cerebrales.....	267
HEIFETZ Pinzas para coger tejidos.....	71
Hemostáticos CASPAR.....	191
HENLEY Separadores autoestáticos.....	121
HESS Separadores de raiz de nervios.....	109

HOEN Disector para duramadre.....	219
HOEN Elevadores.....	205
HOEN Pinzas para laminectomía.....	234
Hojas sueltas para separador cervical.....	142-143
HOLSHER Separadores de raiz de nervios.....	109
HOLZHEIMER Separadores autoestáticos.....	118
Horquilla de implante HARDY.....	258
Horquillas para tumores OKONEK-YASARGIL.....	248
Horquillas para tumores YASARGIL.....	248
HORSLEY Disector para duramadre.....	218
HOSOBUCHI espátula forma horquilla.....	259
HOUSE Tubos de aspiración.....	229
HUDSON Perforador de mano.....	282
HUNT Pinzas para coger tejidos.....	69-70

I

INGE Separadores para vertebrales.....	148
Injerto óseo titular y impactador CASPAR.....	190
Instrumentos para exámenes y medición.....	11
Instrumentos para hipófisis.....	255-264
Instrumentos para hipófisis CUSHING-LANDOLT.....	255
Instrumentos para hipófisis HARDY.....	258, 261
Instrumentos para hipófisis LANDOLT.....	256, 259
Instrumentos para hipófisis NICOLA.....	257
Instrumentos para hipófisis PAPAVERO-CASPAR.....	256
Instrumentos para hipófisis PAPAVERO-HARTMANN.....	256

J

JACOBSON Empujadores de suturas.....	247
JACOBSON Micro tijeras.....	44-45
JACOBSON Micro-cuchillo.....	115
JACOBSON Sonda abotonada.....	243
JACOBSON Sonda doble.....	243

JAMESON WERBER Tijeras de disección.....	26
JANSEN Cucharillas cortantes.....	188
JANSEN Elevadores.....	202
JANSEN Pinzas.....	73
JANSEN Pinzas-gubias.....	160
JANSEN Separadores autoestáticos.....	118
JANSEN-GRUENWALD Pinzas.....	73
JOHNS-HOPKINS Pinzas serra-finás.....	81
JOSEPH Elevador.....	215
JOSEPH Ganchos para la piel.....	100
JOSEPH Periostótomos.....	207

K

KELLY Pinzas hemostáticas.....	83
KELLY Tijeras para cirugía.....	21
KELLY-RANKIN Pinzas hemostáticas.....	83
KERRISON Pinzas.....	279
KEY Elevadores.....	214
KILNER Tijeras de disección.....	26
KLEINERT-KUTZ Pinzas-gubias.....	161
KNIGHTON Separadores para laminectomía.....	132
KOCHER Separadores.....	103
KOCHER-LANGENBECK Separadores.....	102
KÖNIG Elevadores.....	206
KOOS Bisturías.....	243
KOOS Micro cuchillos.....	242
KRAYENBÜHL Ganchos para nervios y vasos.....	114

L

LAMBOTTE Osteotomos.....	194
LAMBOTTE Periostótomos.....	203
LANDOLT cucharilla.....	259
LANDOLT cureta.....	259
LANDOLT enucleador.....	259
LANDOLT gancho.....	259
LANDOLT Instrumentos para hipófisis.....	256, 259
LANDOLT Mangos de bisturías.....	16
LANDOLT pinza para abrir el espejo.....	255
LANDOLT pinza para laminectomía.....	239
LANDOLT Pinza para tumores.....	239
LANDOLT-REULEN Cureta para hipófisis.....	262
LANDOLT-REULEN disector.....	262

LANDOLT-REULEN legra.....	262
LANGENBECK Elevadores.....	205
LANGENBECK Separadores.....	103
LAZAR Micro Pinzas para ligaduras.....	62
Legra de succión GUILLEN.....	230
Legra LANDOLT-REULEN.....	262
Legra NICOLA.....	257
Legra RHOTON.....	250
Legras para micro-cirugía.....	221-222
Legras para micro-cirugía CASPAR.....	223-224
Legras para micro-cirugía YASARGIL.....	221-223
LEKSELL (STILLE) Pinzas-gubias.....	166
LEMPERT Cucharillas cortantes.....	186
LEMPERT Pinzas-gubias.....	160-161
LEXER Cinceles.....	197
LEXER MINI Cinceles.....	197
LEXER MINI Osteotomos.....	197
LEXER Osteotomos.....	197
LEXER Tijeras de disección.....	22
LEYLA Separador de sistema.....	268-272
LISTON Pinzas cortantes para huesos.....	168
LOVE Separadores de raíz de nervios.....	111-112
LOVE-GRUENWALD Pinzas para laminectomía.....	232
LUCAE Pinzas.....	73
LUER Pinzas-gubias.....	159

M

Mango para sierra GIGLI.....	173
Mango para sierra GIGLI STRULLY.....	173
Mango para sierra REDA.....	173
Mangos de bisturías.....	14-16
Mangos de bisturías CASPAR.....	16
Mangos de bisturías LANDOLT.....	16
MARKHAM-MEYERDING Separadores para hemilaminectomía.....	144
MARQUARDT Pinzas-gubias.....	164
MARTEL Pinzas para el cuero cabelludo.....	85
Martillos de percusión BABINSKY.....	8
Martillos de percusión BERLINER.....	8
Martillos de percusión BUCK.....	8
Martillos de percusión DEJERINE.....	8
Martillos de percusión TAYLOR USA Mod.....	8
Martillos de percusión TROEMNER.....	8
Martillos y mazos COTTLE.....	10

Martillos y mazos OMBREDANNE.....	10
Martillos y mazos WAGNER.....	10
Martillos y mazos WILLIGER.....	9
MATSON Periostótomos.....	210
MATSON-ALEXANDER Periostótomos.....	210
MAYFIELD Pinzas-gubias.....	163
MAYO Pinzas de disección sin/con dientes.....	58
MAYO Tijeras de disección.....	22
MAYO-ADAMS Separadores autoestáticos.....	122
MAYO-HEGAR Porta-agujas.....	93
MAYO-STILLE Tijeras de disección.....	22
MC DONALD Elevador.....	215
MC INDOE Pinzas cortantes para huesos.....	168
MC KENZIE broca.....	282
McINDOE Pinzas de disección sin/con dientes.....	55
McKENZIE Pinzas aplicadoras.....	170
METZENBAUM BLACK Tijeras de disección.....	24
METZENBAUM FINO Tijeras de disección.....	23
METZENBAUM Tijeras de disección.....	23
MEYERDING Separadores para hemilaminectomía.....	144
MICHELE Trepano.....	178
Micro Clips vasculares ACLAND.....	297
Micro cuchillos KOOS.....	242
Micro cuchillos YASARGIL.....	242
MICRO FRIEDMAN Pinzas-gubias.....	158
Micro Pinzas.....	65
Micro Pinzas Atraumáticas DE BAKEY.....	66-67
Micro Pinzas de disección sin/con dientes ADSON.....	51-52
Micro Pinzas hemostáticas HALSTED-MOSQUITO.....	82
Micro Pinzas para ligaduras.....	61-63
Micro Pinzas para ligaduras LAZAR.....	62
Micro Pinzas YASARGIL.....	74
Micro tijeras.....	35-46, 266
Micro tijeras CASTROVIEJO.....	36
Micro tijeras de disección.....	46
Micro tijeras JACOBSON.....	44-45
Micro tijeras MILLESI.....	44-45
Micro tijeras NAGEL.....	43
Micro tijeras POTTS-YASARGIL.....	44-45
Micro tijeras VANNAS.....	37, 42, 44-45

Micro tijeras YASARGIL.....	41-42, 44
Micro tubo de aspiración	230
Micro-cucharillas.....	189
Micro-cucharillas YASARGIL	189
Micro-cuchillo JACOBSON.....	115
Micro-ganchitos FISCH	115
Micro-HARTMANN	
Pinzas hemostáticas.....	81
Micro-pinzas	264
Micro-porta-agujas.....	94-98
Micro-porta-agujas BARRAQUER.....	94
Micro-porta-agujas CASTROVIEJO	95
Micro-porta-agujas YASARGIL.....	96
Micro-tijera FAHLBUSCH	263
Micro-tijera NICOLA.....	263
MILLES Micro tijeras	44-45
MILLIGAN Disector	
para duramadre	218
MILLS Tijeras vasculares	29
Mini Pinzas-gubias FRIEDMAN.....	158
MINI-LAMBOTTE Osteotomos.....	195
MISKIMON Separador	
para cerebelo.....	126
MIXTER BABY Pinzas	
para preparaciones y para ligaduras...88	
MOLLISON Separadores	
autoestáticos	120
MOLT Periostótomos	206

N

NAGEL Micro tijeras	43
NEIVERT Porta-agujas	92
NICOLA cureta	257
NICOLA Instrumentos	
para hipófisis	257
NICOLA legra	257
NICOLA Micro-tijera.....	263
NORFOLK-NORWICH	
Separadores autoestáticos.....	122

O

OKONEK-YASARGIL	
Horquillas para tumores	248
OLDBERG pinza	
para laminectomia	239
OLIVECRONA Disector	
para duramadre	217
OLIVECRONA	
Espátulas cerebrales.....	266
OLIVECRONA Pinzas-gubias.....	160
OLIVECRONA sierra	173

OLIVECRONA Tijera	
para trigémino.....	33
OLIVECRONA-TOENNIS	
Pinzas aplicadoras	170
OMBREDANNE Martillos y mazos	10
Osteotome Para la plástica nasal.....	200
Osteotome Para la plástica	
nasal COTTLE.....	200
Osteotomo LEXER MINI.....	197
Osteotomos LAMBOTTE.....	194
Osteotomos LEXER	197
Osteotomos MINI-LAMBOTTE	195
Osteotomos para la plástica nasal	200
Osteotomos STILLE	192

P

PAPAVERO-CASPAR	
Instrumentos para hipófisis.....	256
PAPAVERO-HARTMANN	
Instrumentos para hipófisis.....	256
para cirugía Tijeras	20-21
Para dura-madre CUSHING.....	107
Para dura-madre DANDY.....	106
para hemilaminectomia	
Separadores.....	144-145
PENFIELD Disectores	220
Perforador de mano HUDSON	282
Perforadores de mano	282
Perforadores de mano BUNELL.....	283
Perforadores de mano RALK	283
Perforadores de mano REDA.....	284
Periostótomos ADSON	214
Periostótomos COBB	213
Periostótomos CUSHING	
(LITTLE-JOKER) SEDILLOT	203
Periostótomos DOYEN.....	208-209
Periostótomos FARABEUF.....	202
Periostótomos	
FARABEUF-COLLIN	202-203
Periostótomos FOMON	207
Periostótomos JOSEPH	207
Periostótomos LAMBOTTE	203
Periostótomos MATSON	210
Periostótomos	
MATSON-ALEXANDER	210
Periostótomos MOLT	206
Periostótomos SEDILLOT	203
Periostótomos SELDIN.....	207
Periostótomos WAGNER	213
Periostótomos WILLIGER	206
Pieza alargadera	282

Pinza aplicadora.....	81
Pinza aplicadora para clips RANEY ..172	
Pinza de agarre	
YASARGIL-NICOLA	263
Pinza de succión bipolar.....	292
Pinza guía taladros y protectora	
de duramadre ADSON.....	177
Pinza para abrir el especulo	
LANDOLT	255
Pinza para agarrar	
tendones CAROLL	89
pinza para laminectomia	
LANDOLT	239
pinza para laminectomia	
OLDBERG	239
pinza para laminectomia	
YASARGIL.....	239
Pinza para tumores LANDOLT	239
Pinzas	279-280
Pinzas aplicadoras MCKENZIE.....	170
Pinzas aplicadoras	
OLIVECRONA-TOENNIS	170
Pinzas aplicadoras SMITHWICK.....	170
Pinzas aplicadoras SWEET.....	170
Pinzas Atraumáticas DE BAKEY	68
Pinzas CITELLI.....	280
Pinzas cortantes para huesos ...	168-169
Pinzas cortantes para huesos	
BÖHLER.....	168
Pinzas cortantes para huesos	
COTTLE-KAZANJIAN	168
Pinzas cortantes para huesos	
LISTON.....	168
Pinzas cortantes para huesos	
MC INDOE.....	168
Pinzas cortantes para huesos	
RUSKIN-LISTON.....	168
Pinzas cortantes para	
huesos SEMB.....	169
Pinzas cortantes para	
huesos STAMM	168
Pinzas cortantes para huesos	
STILLE-HORSLEY	169
Pinzas cortantes para huesos	
STILLE-LISTON	169
Pinzas COTTLE.....	73
Pinzas de disección	
sin/con dientes ADLERKREUTZ	54
Pinzas de disección	
sin/con dientes ADSON	51-52
Pinzas de disección	
sin/con dientes ADSON-BROWN.....	52

Pinzas de disección sin/con dientes ADSON-DE BAKEY51	Pinzas para coger tejidos HEIFETZ71	Pinzas sacabocado para discos intervertebrales desmontable recubrimiento negro FERRIS-SMITH-KERRISON.....275, 277
Pinzas de disección sin/con dientes BROPHY54	Pinzas para coger tejidos HUNT ... 69-70	Pinzas sacabocado para discos intervertebrales FERRIS-SMITH- KERRISON..... 274-275
Pinzas de disección sin/con dientes BROWN Micro53	Pinzas para coger tejidos YASARGIL.....69, 71	Pinzas serra-finas DIEFFENBACH81
Pinzas de disección sin/con dientes CUSHING53	Pinzas para coger tejidos YASARGIL-SAMII71	Pinzas serra-finas JOHNS-HOPKINS81
Pinzas de disección sin/con dientes CUSHING-TAYLOR...57	Pinzas para el cuero cabelludo MARTEL.....85	Pinzas-gubias ADSON159
Pinzas de disección sin/con dientes DUEHRSEN55	Pinzas para hipófisis ADSON.....253	Pinzas-gubias BACON162
Pinzas de disección sin/con dientes GERALD..... 56-57	Pinzas para la protección de orificio176	Pinzas-gubias BANE-HARTMANN...160
Pinzas de disección sin/con dientes GILLIES56	Pinzas para laminectomia CASPAR..... 236-237	Pinzas-gubias BEYER.....161, 163
Pinzas de disección sin/con dientes MAYO58	Pinzas para laminectomia CLOWARD233	Pinzas-gubias BÖHLER163
Pinzas de disección sin/con dientes McINDOE55	Pinzas para laminectomia CUSHING232	Pinzas-gubias ECHLIN.....167
Pinzas de disección sin/con dientes POTTS-SMITH50	Pinzas para laminectomia FERRIS-SMITH235	Pinzas-gubias FRIEDMAN158
Pinzas de disección sin/con dientes SEMKEN56	Pinzas para laminectomia HOEN234	Pinzas-gubias FRYKHOLM167
Pinzas de disección sin/con dientes TAYLOR.....58	Pinzas para laminectomia LOVE-GRUENWALD232	Pinzas-gubias JANSEN.....160
Pinzas de disección sin/con dientes WANGENSTEEN58	Pinzas para laminectomia SCHLESINGER.....233	Pinzas-gubias KLEINERT-KUTZ161
Pinzas de disección sin/con dientes WAUGH.....53	Pinzas para laminectomia SPURLING232	Pinzas-gubias LEKSELL (STILLE)....166
Pinzas de relojero..... 59-60	Pinzas para laminectomia WAGNER235	Pinzas-gubias LEMPert 160-161
Pinzas de tracción craneal CRUTCHFIELD172	Pinzas para laminectomia WEIL-BLAKESLEY.....238	Pinzas-gubias LUER159
Pinzas en forma de cuchara.....264	Pinzas para ligaduras Micro 61-63	Pinzas-gubias MARQUARDT.....164
Pinzas HAJEK-KOFLER..... 279-280	Pinzas para preparaciones y para ligaduras ADSON BABY86	Pinzas-gubias MAYFIELD163
Pinzas hemostáticas CRILE83	Pinzas para preparaciones y para ligaduras FUCHSIG.....86	Pinzas-gubias MICRO FRIEDMAN ...158
Pinzas hemostáticas CRILE-RANKIN83	Pinzas para preparaciones y para ligaduras GEMINI87	Pinzas-gubias OLIVECRONA.....160
Pinzas hemostáticas DANDY84	Pinzas para preparaciones y para ligaduras MIXTER BABY.....88	Pinzas-gubias RUSKIN164
Pinzas hemostáticas HALSTED-MOSQUITO82	Pinzas sacabocado craneal CONE ...175	Pinzas-gubias SAUERBRUCH.....166
Pinzas hemostáticas HARTMANN81	Pinzas sacabocado craneal DeVILBISS174	Pinzas-gubias SEMB167
Pinzas hemostáticas KELLY.....83	Pinzas sacabocado para discos intervertebrales..... 274-278	Pinzas-gubias SMITH-PETERSEN ...162
Pinzas hemostáticas KELLY-RANKIN83	Pinzas sacabocado para discos intervertebrales COLCLOUGH.....278	Pinzas-gubias STELLBRINK.....158
Pinzas hemostáticas Micro-HARTMANN81	Pinzas sacabocado para discos intervertebrales desmontable FERRIS-SMITH-KERRISON276	Pinzas-gubias STILLE-LUER165
Pinzas JANSEN.....73		Pinzas-gubias STILLE-RUSKIN165
Pinzas JANSEN-GRUENWALD73		Pinzas-gubias ZAUFGAL-JANSEN.....163
Pinzas KERRISON279		Pinzas-Ultra-Ligeras.....64
Pinzas LUCAE.....73		PLESTER Separadores autoestáticos120, 122
Pinzas Micro65		PLESTER Tubos de aspiración229
		Porta-agujas BAUMGARTNER92
		Porta-agujas CRILE-WOOD.....92
		Porta-agujas DE BAKEY93
		Porta-agujas HALSEY92
		Porta-agujas MAYO-HEGAR.....93
		Porta-agujas Micro..... 94-98
		Porta-agujas NEIVERT.....92
		Porta-agujas RYDER.....93
		POTTS-DE MARTEL
		Tijeras vasculares.....29
		POTTS-SMITH Pinzas de disección sin/con dientes.....50

POTTS-SMITH	
Tijeras vasculares.....	30-31
POTTS-YASARGIL Micro tijeras ...	44-45

Q

QUERVAIN Elevadores.....	204
--------------------------	-----

R

RALK Perforadores de mano	283
RANEY pinza aplicadora para clips...	172
REDA Cucharillas cortantes	186-187
REDA mango para sierra.....	173
REDA Perforadores de mano	283
REDA Rompe-hojas	17
Retractores cervicales.....	137-141
REYNOLDS Tijeras de disección	26
RHOTON Disector.....	250
RHOTON esonda abotonada	250
RHOTON espátulado	250
RHOTON Gancho	250
RHOTON Legra.....	250
Riel para grapas	170
ROGER Elevador	216
Rompe-hojas CASTROVIEJO.....	17
Rompe-hojas REDA	17
Rompe-hojas TROUTMAN-CHRIS	17
RUSKIN Pinzas-gubias	164
RUSKIN-LISTON Pinzas cortantes para huesos.....	168
RYDER Porta-agujas.....	93

S

SACHS Disector para duramadre	217
SACHS Ganchos para nervios.....	108
SAMII Cuchillo lanceolar	246
SAMII Cuchillos para tumores ...	245-246
SAMII Pinzas para coger tejidos	72
SAUERBRUCH Costótomos	48
SAUERBRUCH Pinzas-gubias.....	166
SAUERBRUCH-FREY Costótomos	48
SCALP-CONTOUR Separador para el cuero cabelludo	125
SCHLESINGER Pinzas para laminectomía	233
SCHMIEDEN-TAYLOR Tijeras para duramadre	34
SCOVILLE Cucharillas cortantes	183
SCOVILLE Separadores de raíz de nervios	109, 112
SCOVILLE Separadores para laminectomía.....	135

SCOVILLE-HAVERFIELD Separadores para laminectomía	135
SCOVILLE-RICHTER Separadores para laminectomía.....	136
SEBILÉAU Elevadores.....	204
SEDILLOT Elevadores	204
SEDILLOT Periostótomos	203
SELDIN Periostótomos.....	207
SEMB Pinzas cortantes para huesos.....	169
SEMB Pinzas-gubias.....	167
SEMKEN Pinzas de disección sin/con dientes.....	56
Sensímetro WARTENBERG.....	11
Separador cervical CLOWARD .	137-140
Separador de sistema LEYLA ...	268-272
Separador de sistema YASARGIL.....	268-272
Separador para cerebelo ANDERSON ADSON.....	126
Separador para cerebelo MISKIMON.....	126
Separador para el cuero cabelludo SCALP-CONTOUR	125
Separador para vasos BIEMER	244
Separadores autoestáticos ADSON.....	123-124
Separadores autoestáticos ALM.....	118
Separadores autoestáticos BECK- MANN-ADSON (CONE) ADSON.....	124
Separadores autoestáticos HENLEY	121
Separadores autoestáticos HOLZHEIMER.....	118
Separadores autoestáticos JANSEN	118
Separadores autoestáticos MAYO-ADAMS	122
Separadores autoestáticos MOLLISON.....	120
Separadores autoestáticos NORFOLK-NORWICH	122
Separadores autoestáticos PLESTER	120, 122
Separadores autoestáticos TRAVERS	123
Separadores autoestáticos WEITLANER.....	119
Separadores autoestáticos WEITLANER-WULLSTEIN.....	119
Separadores autoestáticos WULLSTEIN.....	120

Separadores CLOWARD.....	101
Separadores CUSHING	101
Separadores de raíz de nervios CASPAR	110
Separadores de raíz de nervios D'ERRICO.....	111
Separadores de raíz de nervios HESS	109
Separadores de raíz de nervios HOLSHER.....	109
Separadores de raíz de nervios LOVE	111-112
Separadores de raíz de nervios SCOVILLE	109, 112
Separadores espinales TAYLOR.....	105
Separadores GELPI	146
Separadores KOCHER.....	103
Separadores KOCHER-LANGENBECK	102
Separadores LANGENBECK	103
Separadores lumbales autoestáticos	152-153
Separadores lumbales autoestáticos CASPAR.....	150, 152
Separadores MEYERDING	104
Separadores para hemilaminectomía	144-145
Separadores para hemilaminectomía MARKHAM-MEYERDING	144
Separadores para hemilaminectomía MEYERDING.....	144
Separadores para hemilaminectomía WILLIAMS	145
Separadores para laminectomía	127-137
Separadores para laminectomía ADSON.....	127
Separadores para laminectomía BECKMANN.....	130
Separadores para laminectomía BECKMANN-ADSON	128
Separadores para laminectomía BECKMANN-EATON.....	130
Separadores para laminectomía CASPAR.....	134
Separadores para laminectomía HARVEY-JACKSON	131
Separadores para laminectomía KNIGHTON.....	132
Separadores para laminectomía SCOVILLE	135

Separadores para laminectomía	
SCOVILLE-HAVERFIELD	135
Separadores para laminectomía	
SCOVILLE-RICHTER	136
Separadores para laminectomía	
TAYLOR	135
Separadores para laminectomía	
WALTON	133
Separadores para vertebrales	
CLOWARD	147, 149
Separadores para vertebrales	
INGE	148
SEWALL Elevador	215
Sierra OLIVECRONA	173
Sistema de distracción vertebral	156
SMITH-PETERSEN Gubias	193
SMITH-PETERSEN Pinzas-gubias	162
SMITHWICK Ganchos para nervios	108
SMITHWICK Pinzas aplicadoras	170
Sonda abotonada JACOBSON	243
Sonda doble JACOBSON	243
SPINAL Cucharillas cortantes	182
SPRATT Cucharillas cortantes	180
SPURLING Pinzas para laminectomía	232
STAMM Pinzas cortantes para huesos	168
STANDARD Tijeras para cirugía	20
STELLBRINK Pinzas-gubias	158
STEVENS Tijeras finas	28
STILLE Cinceles	192
STILLE Gubias	192
STILLE Osteotomos	192
STILLE-HORSLEY Pinzas cortantes para huesos	169
STILLE-LISTON Pinzas cortantes para huesos	169
STILLE-LUER Pinzas-gubias	165
STILLE-RUSKIN Pinzas-gubias	165
STRULLY tijera para neurocirugía	33
SWEET Pinzas aplicadoras	170

T

TAYLOR Pinzas de disección sin/con dientes	58
TAYLOR Separadores espinales	105
TAYLOR Separadores para laminectomía	135
TAYLOR USA Mod. Martillos de percusión	8
Tijera para neurocirugía DANDY	33

Tijera para neurocirugía STRULLY	33
Tijera para trigémino OLIVECRONA	33
Tijera para tumores	47
Tijera para venas BIEMER	44-45
Tijeras de disección	22-27
Tijeras de disección	
BABY-METZENBAUM BLACK	25
Tijeras de disección BLACK	25
Tijeras de disección	
JAMESON WERBER	26
Tijeras de disección KILNER	26
Tijeras de disección LEXER	22
Tijeras de disección MAYO	22
Tijeras de disección MAYO-STILLE	22
Tijeras de disección METZENBAUM	23
Tijeras de disección	
METZENBAUM BLACK	24
Tijeras de disección	
METZENBAUM FINO	23
Tijeras de disección Micro	46
Tijeras de disección	
para nervios TOENNIS-ADSON	27
Tijeras de disección REYNOLDS	26
Tijeras de disección YASARGIL	41-42
Tijeras finas	27
Tijeras finas GRADLE	28
Tijeras finas STEVENS	28
Tijeras Micro	35-46, 266
Tijeras para alambre y láminas	
UNIVERSAL	34
Tijeras para cirugía	20-21
Tijeras para cirugía DEEVER	21
Tijeras para cirugía KELLY	21
Tijeras para cirugía STANDARD	20
Tijeras para duramadre	
SCHMIEDEN-TAYLOR	34
Tijeras vasculares	29-32
Tijeras vasculares DE BAKEY	31-32
Tijeras vasculares DE BAKEY (POTTS-SMITH)	30
Tijeras vasculares DIETRICH	29-30
Tijeras vasculares FAVALORO	32
Tijeras vasculares MILLS	29
Tijeras vasculares	
POTTS-DE MARTEL	29
Tijeras vasculares POTTS-SMITH	30-31
TOENNIS Disector para duramadre	217
TOENNIS-ADSON Tijeras de disección para nervios	27
TRAVERS Separadores autoestáticos	123
Trepano MICHELE	180

Trépanos craneales GALT	177
TROEMNER Martillos de percusión	8
TROUTMAN-CHRIS Rompe-hojas	17
Tubos de aspiración	226-230
Tubos de aspiración ADSON	226
Tubos de aspiración BARON	226
Tubos de aspiración	
FERGUSON	226-227
Tubos de aspiración	
FRAZIER/FERGUSON	227
Tubos de aspiración HOUSE	229
Tubos de aspiración PLESTER	229
Tubos de aspiración WULLSTEIN	230
Tubos de aspiración YASARGIL	228
Tubos de aspiración ZÖLLNER	228

U

UNIVERSAL Tijeras para alambre y láminas	34
--	----

V

VANNAS Micro tijeras	37, 42, 44-45
VOLKMANN cortantes	180
VOLKMANN Cucharillas cortantes	188

W

WAGNER Martillos y mazos	10
WAGNER Periostótomos	213
WAGNER Pinzas para laminectomía	235
WALTON Separadores para laminectomía	133
WANGENSTEEN Pinzas de disección sin/con dientes	58
WARTENBERG Sensímetro	11
WATSON-CHEYNE Elevador	215
WAUGH Pinzas de disección sin/con dientes	53
WEIL-BLAKESLEY Pinzas para laminectomía	238
WEITLANER Separadores autoestáticos	119
WEITLANER-WULLSTEIN Separadores autoestáticos	119
WILLIAMS Separadores para hemilaminectomía	145
WILLIGER Martillos y mazos	9
WILLIGER Periostótomos	206
WOODSON Disector para duramadre	219

WULLSTEIN Separadores autoestáticos	120
WULLSTEIN Tubos de aspiración.....	230

Y

YASARGIL Gancho para galea	112
YASARGIL Guia para ligaduras.....	114
YASARGIL Horquillas para tumores	248
YASARGIL Legras para micro-cirugía	221-223
YASARGIL Micro cuchillos	242
YASARGIL Micro Pinzas	74
YASARGIL Micro tijeras.....	41-42, 44
YASARGIL Micro-cucharillas.....	189
YASARGIL Micro-porta-agujas	96
YASARGIL pinza para laminectomía	239
YASARGIL Pinzas para coger tejidos	69, 71
YASARGIL Separador de sistema	268-272
YASARGIL Tijeras de disección	41-42
YASARGIL Tubos de aspiración.....	228
YASARGIL-NICOLA Pinza de agarre	263
YASARGIL-SAMII Pinzas para coger tejidos	71

Z

ZAUFAL-JANSEN Pinzas-gubias.....	163
ZIELKE Gubias.....	198
ZÖLLNER Tubos de aspiración.....	228

A

AACHEN Spatole cerebrali.....	266
ACLAND Micro Clips vascolari.....	296
ADLERKREUTZ Pinze per dissezione chirurgiche/anatomiche.....	54
ADSON BABY Pinze per preparazione e per legatura.....	86
ADSON Divaricatori autostatici..	123-124
ADSON Divaricatori per laminectomia.....	127
ADSON Micro Pinze per dissezione chirurgiche/anatomiche.....	51-52
ADSON Periostotomi.....	214
ADSON Pinze guida-perforatore e proteggi dura-madre.....	177
ADSON Pinze per dissezione chirurgiche/anatomiche.....	51-52
ADSON Pinze per ipofisi.....	253
ADSON Pinze sgorbie.....	159
ADSON Tubi aspirazioni.....	226
ADSON Uncini per nervi.....	108
ADSON-BROWN Pinze per dissezione chirurgiche/anatomiche.....	52
ADSON-DE BAKEY Pinze per dissezione chirurgiche/anatomiche.....	51
ALEXANDER Elevatori.....	206
Algesimetro WARTENBERG.....	11
ALM Divaricatori autostatici.....	118
ANDERSON ADSON Divaricatore per cervelletto.....	126
Arco per trazione craniale CRUTCHFIELD.....	172

B

BABINSKY Martelli da percussione.....	8
BABY-METZENBAUM BLACK Forbici per dissezione.....	25
BACON Pinze sgorbie.....	162
BANE-HARTMANN Pinze sgorbie.....	160
BARON Tubi aspirazioni.....	226
BARRAQUER Micro portaghi.....	94
BAUMGARTNER Port'aghi.....	92
BECKMANN Divaricatori per laminectomia.....	130
BECKMANN-ADSON (CONE) ADSON Divaricatori autostatici.....	124
BECKMANN-ADSON Divaricatori per laminectomia.....	128
BECKMANN-EATON Divaricatori per laminectomia.....	130
BERLINER Martelli da percussione.....	8

BEYER Pinze sgorbie.....	161, 163
BIEMER Divaricatore per vasi.....	244
BIEMER Forbice per vene.....	44-45
Bisturi KOOS.....	243
BLACK Forbici per dissezione.....	25
BÖHLER Cesioie per ossa.....	168
BÖHLER Pinze sgorbie.....	163
BOIES sgorbia.....	207
BROPHY Pinze per dissezione chirurgiche/anatomiche.....	54
BROWN Micro Pinze per dissezione chirurgiche/anatomiche.....	53
BRUNS Curette taglienti.....	184
BUCK Martelli da percussione.....	8
BUNELL Perforatori a mano.....	283
BUSHE Curette taglienti.....	187

C

CAPENER Sgorbie per la colonna vertebrale.....	199
CAROLL Pinze da presa per tendini.....	89
CASPAR Curette taglienti.....	183
CASPAR Divaricatori autostatici lombari.....	150, 152
CASPAR Divaricatori per laminectomia.....	134
CASPAR Manici per lame bisturi.....	16
CASPAR Micro periostotomi.....	223-224
CASPAR Pinze per laminectomia.....	236-237
CASPAR Pistoni.....	191
CASPAR Sistema di distrazione vertebrale cervicale.....	154
CASPAR Sonda Conduttrice a forchetta.....	247
CASPAR Sostegno osseo e impattatore.....	190
CASPAR Specolo per ernia discale lombare.....	151
CASPAR Uncini per esplorazione e coagulazione.....	113
CASPAR Uncini per le radici dei nervi.....	110
CASTROVIEJO Micro Forbici.....	36
CASTROVIEJO Micro portaghi.....	95
CASTROVIEJO Rompi lama di rasoio.....	17
Cavi di collegamento bipolari.....	293
Cervicale Divaricatori.....	137-141
Cesioie per ossa.....	168-169
Cesioie per ossa BÖHLER.....	168

Cesioie per ossa COTTLE-KAZANJIAN.....	168
Cesioie per ossa LISTON.....	168
Cesioie per ossa MC INDOE.....	168
Cesioie per ossa RUSKIN-LISTON.....	168
Cesioie per ossa SEMB.....	169
Cesioie per ossa STAMM.....	168
Cesioie per ossa STILLE-HORSLEY.....	169
Cesioie per ossa STILLE-LISTON.....	169
Chirurgia Forbici.....	20-21
CITELLI Pinze-Punzoni.....	280
CLOWARD Divaricatore cervicale.....	137-140
CLOWARD Divaricatori.....	101
CLOWARD Pinze per laminectomia.....	233
CLOWARD Separatori per vertebre.....	147, 149
Coagulazione bipolare.....	286-291
COBB Curette taglienti.....	181
COBB Periostotomi.....	213
COBB sgorbia.....	196
COLCLOUGH Pinze taglienti per dischi intervertebrali.....	278
Coltelli lanceolari SAMII.....	246
Coltelli per tumori SAMII.....	245-246
Coltello per vasi JACOBSON Micro.....	115
Conduttori per legature YASARGIL.....	114
CONE Curette anulari.....	252
CONE Pinza per craniotomia.....	175
Costotomi GIERTZ-STILLE.....	48
Costotomi SAUERBRUCH.....	48
Costotomi SAUERBRUCH-FREY.....	48
COTTLE Martelli.....	10
COTTLE Osteotomo per plastica nasale.....	200
COTTLE Pinze.....	73
COTTLE-KAZANJIAN Cesioie per ossa.....	168
CRILE Pinze emostatiche.....	83
CRILE Uncini per nervi.....	107
CRILE-RANKIN Pinze emostatiche.....	83
CRILE-WOOD Port'aghi.....	92
CRUTCHFIELD Arco per trazione craniale.....	172
Cucchiaino FAHLBUSCH.....	262
Cucchiaino LANDOLT.....	259
Curetta.....	254
Curetta FAHLBUSCH.....	262
Curetta LANDOLT.....	259

Curetta NICOLA.....	257	DE BAKEY Pinze Atraumatiche.....	68	Divaricatori autostatici ALM	118
Curetta per ipofisi FAHLBUSCH.....	262	DE BAKEY Port'aghi	93	Divaricatori autostatici BECKMANN-ADSON (CONE) ADSON	124
Curetta per ipofisi HARDY	260	DE BAKEY-DIETHRICH		Divaricatori autostatici HENLEY	121
Curetta per ipofisi		Mini Pinze Bulldog.....	76	Divaricatori autostatici	
LANDOLT-REULEN.....	262	DE BAKEY-HESS Pinze		HOLZHEIMER.....	118
Curette anulari CONE.....	252	Atrauma Bulldog.....	80	Divaricatori autostatici JANSEN	118
Curette taglienti BRUNS.....	184	DEAVER Forbici per chirurgia	21	Divaricatori autostatici lombari... 152-153	
Curette taglienti BUSHE.....	187	DECKER Pinze taglienti per laminectomia	234	Divaricatori autostatici	
Curette taglienti CASPAR.....	183	DEJERINE Martelli da percussione.....	8	lombari CASPAR	150, 152
Curette taglienti COBB	181	Delicate Forbici.....	27	Divaricatori autostatici	
Curette taglienti DAUBENSPECK	185	DeMARTEL strumenti introduttori.....	173	MAYO-ADAMS	122
Curette taglienti HALLE	182	DeVILBISS Pinza per craniotomia.....	174	Divaricatori autostatici MOLLISON.....	120
Curette taglienti JANSEN	188	Diapason	11	Divaricatori autostatici	
Curette taglienti LEMPERS	186	DIEFFENBACH Pinze serratina	81	NORFOLK-NORWICH	122
Curette taglienti REDA.....	186-187	DIETHRICH Mini Pinze Bulldog	76	Divaricatori autostatici	
Curette taglienti SCOVILLE.....	183	DIETRICH Forbici vascolari.....	29-30	PLESTER	120, 122
Curette taglienti SPINAL.....	182	Dissettore HARDY-FAHLBUSCH	258	Divaricatori autostatici TRAVERS	123
Curette taglienti SPRATT	180	Dissettore LANDOLT-REULEN	262	Divaricatori autostatici	
Curette taglienti VOLKMANN	188	Dissettore RHOTON.....	250	WEITLANER.....	119
CUSHING (LITTLE-JOKER)		Dissettori GORNEY	207	Divaricatori autostatici	
SEDILLOT Periototomi	203	Dissettori PENFIELD	220	WEITLANER-WULLSTEIN.....	119
CUSHING Divaricatori.....	101	Dissettori per dura-madre		Divaricatori autostatici	
CUSHING Elevatori.....	204	DAVIS	217-218	WULLSTEIN	120
CUSHING Per dura-madre.....	107	Dissettori per		Divaricatori cervicale	137-141
CUSHING Pinze per dissezione chirurgiche/anatomiche	53	dura-madre FRAZIER.....	219	Divaricatori CLOWARD	101
CUSHING Pinze per laminectomia.....	232	Dissettori per		Divaricatori CUSHING	101
CUSHING Spatole cerebrali	266	dura-madre HOEN.....	219	Divaricatori GELPI	146
CUSHING trapano.....	282	Dissettori per		Divaricatori KOCHER	103
CUSHING-LANDOLT		dura-madre HORSLEY	218	Divaricatori	
Strumenti per ipofisi.....	255	Dissettori per		KOCHER-LANGENBECK	102
CUSHING-TAYLOR Pinze per dissezione chirurgiche/anatomiche	57	dura-madre MILLIGAN	218	Divaricatori LANGENBECK	103
		Dissettori per		Divaricatori MEYERDING.....	104
		dura-madre OLIVECRONA.....	217	Divaricatori per emilaminectomia.....	144-145
		Dissettori per		Divaricatori per emilaminectomia	
		dura-madre SACHS.....	217	MARKHAM-MEYERDING	144
		Dissettori per		Divaricatori per	
		dura-madre TOENNIS	217	emilaminectomia MEYERDING.....	144
		Dissettori per		Divaricatori per	
		dura-madre WOODSON.....	219	emilaminectomia WILLIAMS	145
		Divaricatore autostatico per cuoio capelluto		Divaricatori per laminectomia	127-137
		SCALP-CONTOUR	125	Divaricatori per	
		Divaricatore cervicale		laminectomia ADSON.....	127
		CLOWARD	137-140	Divaricatori per	
		Divaricatore per cervello		laminectomia BECKMANN.....	130
		ANDERSON ADSON.....	126	Divaricatori per laminectomia	
		Divaricatore per cervello		BECKMANN-ADSON	128
		MISKIMON	126	Divaricatori per laminectomia	
		Divaricatore per vasi BIEMER.....	244	BECKMANN-EATON.....	130
		Divaricatori autostatici		Divaricatori per laminectomia	
		ADSON.....	123-124	CASPAR	134

D

D'ERRICO Uncini per le radici dei nervi.....	111
DANDY forbici per neurochirurgia	33
DANDY Per dura-madre.....	106
DANDY Pinze emostatiche.....	84
DANDY Uncini per nervi	106
DAUBENSPECK Curette taglienti	185
DAVIS Dissettori	
per dura-madre.....	217-218
DAVIS Spatole cerebrali	267
DE BAKEY (POTTS-SMITH) Forbici vascolari.....	30
DE BAKEY Forbici vascolari.....	31-32
DE BAKEY Micro	
Pinza Atraumatica.....	66-67
DE BAKEY Pinze Atrauma Bulldog.....	79

Divaricatori per laminectomia	
HARVEY-JACKSON.....	131
Divaricatori per laminectomia	
KNIGHTON.....	132
Divaricatori per laminectomia	
SCOVILLE.....	135
Divaricatori per laminectomia	
SCOVILLE-HAVERFIELD.....	135
Divaricatori per laminectomia	
SCOVILLE-RICHTER.....	136
Divaricatori per laminectomia	
TAYLOR.....	135
Divaricatori per laminectomia	
WALTON.....	133
Divaricatori per	
Emilaminectomia.....	144-145
Divaricatori spinali TAYLOR.....	105
DOYEN Periostotomi.....	208-209
DUEHRSEN Pinze per	
dissezione chirurgiche/anatomiche.....	55

E

ECHLIN Pinze sgorbie.....	167
Elevatori.....	211-216
Elevatori ALEXANDER.....	206
Elevatori CUSHING.....	204
Elevatori FREER.....	216
Elevatori HOEN.....	205
Elevatori JANSEN.....	202
Elevatori JOSEPH.....	215
Elevatori KEY.....	214
Elevatori KÖNIG.....	206
Elevatori LANGENBECK.....	205
Elevatori MC DONALD.....	215
Elevatori QUERVAIN.....	204
Elevatori ROGER.....	216
Elevatori SEBILEAU.....	204
Elevatori SEDILLOT.....	204
Elevatori SEWALL.....	215
Elevatori WATSON-CHEYNE.....	215
Enucleatore HARDY.....	258
Enucleatore LANDOLT.....	259
ERRICO trapano.....	282

F

FAHLBUSCH cucchiaino.....	262
FAHLBUSCH curetta.....	262
FAHLBUSCH Curetta per ipofisi.....	262
FAHLBUSCH Micro forbice.....	263
FARABEUF Periostotomi.....	202
FARABEUF-COLLIN	

Periostotomi.....	202-203
FAVALORO Forbici vascolari.....	32
FERGUSSON Tubi aspirazioni..	226-227
FERRIS-SMITH Pinze	
per laminectomia.....	235
FERRIS-SMITH-KERRISON Pinze	
taglienti per dischi	
intervertebrali.....	274-275
FERRIS-SMITH-KERRISON Pinze	
taglienti per dischi intervertebrali	
smontabile a fucile.....	276
FERRIS-SMITH-KERRISON Pinze	
taglienti per dischi intervertebrali	
smontabile a fucile superficie	
antireflesso nera.....	275, 277
FISCH Micro uncinetti.....	115
FISCH Uncino dura madre.....	243
FISCH Uncino molto fino.....	243
FOMON Periostotomi.....	207
Forbice per tumori.....	47
Forbice per vene BIEMER.....	44-45
Forbici delicate.....	27
Forbici delicate GRADLE.....	28
Forbici delicate STEVENS.....	28
Forbici Micro.....	35-46, 266
Forbici per chirurgia.....	20-21
Forbici per chirurgia DEEVER.....	21
Forbici per chirurgia KELLY.....	21
Forbici per chirurgia STANDARD.....	20
Forbici per dissezione.....	22-27
Forbici per dissezione	
BABY-METZENBAUM BLACK.....	25
Forbici per dissezione BLACK.....	25
Forbici per dissezione	
JAMESON WERBER.....	26
Forbici per dissezione KILNER.....	26
Forbici per dissezione LEXER.....	22
Forbici per dissezione MAYO.....	22
Forbici per dissezione	
MAYO-STILLE.....	22
Forbici per dissezione	
METZENBAUM.....	23
Forbici per dissezione	
METZENBAUM BLACK.....	24
Forbici per dissezione	
METZENBAUM FINO.....	23
Forbici per dissezione Micro.....	46
Forbici per dissezione REYNOLDS.....	26
Forbici per dissezione	
YASARGIL.....	41-42
Forbici per dura-madre	
SCHMIEDEN-TAYLOR.....	34

Forbici per filo di metallo	
e lamiera UNIVERSAL.....	34
Forbici per neurochirurgia DANDY.....	33
Forbici per neurochirurgia STRULLY.....	33
Forbici per trigemino	
OLIVECRONA.....	33
Forbici vascolari.....	29-32
Forbici vascolari DE BAKEY.....	31-32
Forbici vascolari DE BAKEY	
(POTTS-SMITH).....	30
Forbici vascolari DIETRICH.....	29-30
Forbici vascolari FAVALORO.....	32
Forbici vascolari MILLS.....	29
Forbici vascolari	
POTTS-DE MARTEL.....	29
Forbici vascolari	
POTTS-SMITH.....	30-31
Forchetta per trapianti HARDY.....	258
Forchetta per tumori	
Forchetta per tumori YASARGIL.....	248
FRAZIER Dissettori per dura-madre.....	219
FRAZIER Uncini per pelle.....	100
FRAZIER/FERGUSSON	
Tubi aspirazioni.....	227
FREER Elevatori.....	216
FREER Uncini per pelle.....	100
FRIEDMAN Mini Pinze sgorbie.....	158
FRIEDMAN Pinze sgorbie.....	158
FRYKHOLM Pinze sgorbie.....	167
FUCHSIG Pinze per	
preparazione e per legatura.....	86

G

GALT Trapano cranico.....	177
Gancio RHOTON.....	250
GELPI Divaricatori.....	146
GEMINI Pinze per preparazione	
e per legatura.....	87
GERALD Pinze per dissezione	
chirurgiche/anatomiche.....	56-57
GIERTZ-STILLE Costotomi.....	48
GIGLI manico per sega.....	173
GIGLI STRULLY manico per sega.....	173
GILLIES Pinze per dissezione	
chirurgiche/anatomiche.....	56
GILLIES Uncini per pelle.....	100
Giunto di prolungamento.....	282
GLOVER Pinze Atrauma Bulldog..	79-80
GORNEY Dissettori.....	207
GRADLE Forbici delicate.....	28
GRAHAM Uncini per nervi.....	108

GUILLEN Raspatorio
con aspiratore.....230

H

HAJEK-KOFLER
Pinze-Punzoni 279-280
HALLE Curette taglienti.....182
HALSEY Port'aghi92
HALSTED-MOSQUITO Micro Pinze
emostatiche82
HALSTED-MOSQUITO
Pinze emostatiche82
HARDY Curretta per ipofisi260
HARDY enucleatore258
HARDY forchetta per trapianti258
HARDY Strumenti per ipofisi258, 261
HARDY-FAHLBUSCH dissettore258
HARTMANN Pinze emostatiche81
HARVEY-JACKSON Divaricatori
per laminectomia131
HEIFETZ Pinze per afferrare tessuti ..71
HEIFETZ Spatole cerebrali.....267
HENLEY Divaricatori autostatici121
HESS Uncini per le radici dei nervi...109
HOEN Dissettori per dura-madre219
HOEN Elevatori205
HOEN Pinze per laminectomia.....234
HOLSHER Uncini per
le radici dei nervi.....109
HOLZHEIMER
Divaricatori autostatici118
HORSLEY Dissettori
per dura-madre218
HOSOBUCHI spatola
forma a forchetta259
HOUSE Tubi aspirazioni.....229
HUDSON perforatore a mano282
HUNT Pinze per afferrare tessuti .. 69-70

I

INGE Separatori per vertebre.....148

J

JACOBSON Micro coltello per vasi ... 115
JACOBSON Micro Forbici 44-45
JACOBSON Sonda bottonuta243
JACOBSON Sonda
Conduttrice a forchetta247
JACOBSON Sonda doppia.....243
JAMESON WERBER Forbici
per dissezione26

JANSEN Curette taglienti188
JANSEN Divaricatori autostatici 118
JANSEN Elevatori202
JANSEN Pinze73
JANSEN Pinze sgorbie.....160
JANSEN-GRUENWALD Pinze73
JOHNS-HOPKINS Pinze serrafina81
JOSEPH Elevatori215
JOSEPH Periostotomi207
JOSEPH Uncini per pelle100

K

KELLY Forbici per chirurgia.....21
KELLY Pinze emostatiche83
KELLY-RANKIN Pinze emostatiche83
KERRISON Pinze-Punzoni.....279
KEY Elevatori214
KILNER Forbici per dissezione.....26
KLEINERT-KUTZ Pinze sgorbie161
KNIGHTON Divaricatori
per laminectomia132
KOCHER Divaricatori103
KOCHER-LANGENBECK
Divaricatori.....102
KÖNIG Elevatori206
KOOS Bisturi243
KOOS Micro coltelli per vasi.....242
KRAYENBÜHL Uncini
per nervi e vasi114

L

LAMBOTTE Osteotomi.....194
LAMBOTTE Periostotomi203
LANDOLT cucchiaio259
LANDOLT curretta259
LANDOLT enucleatore259
LANDOLT Manici per lame bisturi16
LANDOLT pinze per
aprire gli specoli.....255
LANDOLT Pinze per ipofisi239
LANDOLT pinze per laminectomia ...239
LANDOLT Strumenti per ipofisi .256, 259
LANDOLT uncino smusso259
LANDOLT-REULEN Curretta
per ipofisi262
LANDOLT-REULEN dissettore262
LANDOLT-REULEN raspatore262
LANGENBECK Divaricatori103
LANGENBECK Elevatori205
LAZAR Micro Pinze per legature62
LEKSELL (STILLE) Pinze sgorbie.....166

LEMPERT Curette taglienti186
LEMPERT Pinze sgorbie 160-161
LEXER Forbici per dissezione.....22
LEXER MINI Osteotomi.....197
LEXER MINI Scalpelli.....197
LEXER Osteotomi197
LEXER Scalpelli197
LEYLA Sistema di fissaggio268-272
LISTON Cesioie per ossa.....168
LOVE Uncini per le
radici dei nervi 111-112
LOVE-GRUENWALD Pinze
per laminectomia232
LUCAE Pinze73
LUER Pinze sgorbie.....159

M

Manici per lame bisturi..... 14-16
Manici per lame bisturi CASPAR16
Manici per lame bisturi LANDOLT16
Manico per sega GIGLI173
Manico per sega GIGLI STRULLY ...173
Manico per sega REDA173
MARKHAM-MEYERDING Divaricatori
per emilaminectomia144
MARQUARDT Pinze sgorbie.....164
MARTEL Pinze per cuoio capelluto....85
Martelli COTTLE.....10
Martelli da percussione BABINSKY.....8
Martelli da percussione BERLINER.....8
Martelli da percussione BUCK.....8
Martelli da percussione DEJERINE.....8
Martelli da percussione
TAYLOR USA Mod8
Martelli da percussione TROEMNER...8
Martelli OMBREDANNE10
Martelli WAGNER10
Martelli WILLIGER.....9
MATSON Periostotomi210
MATSON-ALEXANDER
Periostotomi.....210
MAYFIELD Pinze sgorbie163
MAYO Forbici per dissezione22
MAYO Pinze per dissezione
chirurgiche/anatomiche58
MAYO-ADAMS Divaricatori
autostatici122
MAYO-HEGAR Port'aghi93
MAYO-STILLE Forbici
per dissezione22
MC DONALD Elevatori215

MC INDOE Cesioie per ossa.....	168	MINI-LAMBOTTE Osteotomi.....	195	Perforatore a mano HUDSON.....	282	
MC KENZIE trapano.....	282	MISKIMON Divaricatore per cervelloletto.....	126	Perforatori a mano.....	282	
McINDOE Pinze per dissezione chirurgiche/anatomiche.....	55	MIXTER BABY Pinze per preparazione e per legatura.....	88	Perforatori a mano BUNELL.....	283	
McKENZIE Pinza per applicare.....	170	MOLLISON Divaricatori autostatici.....	120	Perforatori a mano RALK.....	283	
METZENBAUM BLACK Forbici per dissezione.....	24	MOLT Periostotomi.....	206	Perforatori a mano REDA.....	284	
METZENBAUM FINO Forbici per dissezione.....	23	N			Periostotomi ADSON.....	214
METZENBAUM Forbici per dissezione.....	23	NAGEL Micro Forbici.....	43	Periostotomi COBB.....	213	
MEYERDING Divaricatori.....	104	NEIVERT Port'aghi.....	92	Periostotomi CUSHING (LITTLE-JOKER).....	203	
MEYERDING Divaricatori per emilaminectomia.....	144	NICOLA curetta.....	257	Periostotomi DOYEN.....	208-209	
MICHELE Punta trapano.....	178	NICOLA Micro forbice.....	263	Periostotomi FARABEUF.....	202	
Micro Clips vascolari ACLAND.....	297	NICOLA raspatore.....	257	Periostotomi FARABEUF-COLLIN.....	202-203	
Micro coltelli per vasi KOOS.....	242	NICOLA Strumenti per ipofisi.....	257	Periostotomi FOMON.....	207	
Micro coltelli per vasi YASARGIL.....	242	NORFOLK-NORWICH Divaricatori autostatici.....	122	Periostotomi JOSEPH.....	207	
Micro curette.....	189	O			Periostotomi LAMBOTTE.....	203
Micro curette YASARGIL.....	189	OKONEK-YASARGIL Forchetta per tumori.....	248	Periostotomi MATSON.....	210	
Micro forbice FAHLBUSCH.....	263	OLDBERG pinze per laminectomia.....	239	Periostotomi MATSON-ALEXANDER.....	210	
Micro forbice NICOLA.....	263	OLIVECRONA Dissettori per dura-madre.....	217	Periostotomi MOLT.....	206	
Micro Forbici.....	35-46, 266	OLIVECRONA Forbici per trigemino.....	33	Periostotomi RHOTON.....	250	
Micro Forbici CASTROVIEJO.....	36	OLIVECRONA Pinze scorbie.....	160	Periostotomi SEDILLOT.....	203	
Micro Forbici JACOBSON.....	44-45	OLIVECRONA sega.....	173	Periostotomi SELDIN.....	207	
Micro Forbici MILLESI.....	44-45	OLIVECRONA Spatole cerebrali.....	266	Periostotomi WAGNER.....	213	
Micro Forbici NAGEL.....	43	OLIVECRONA-Toennis Pinza per applicare.....	170	Periostotomi WILLIGER.....	206	
Micro forbici per dissezione.....	46	OMBREDANNE Martelli.....	10	Pinza applicatrice.....	81	
Micro Forbici POTTS-YASARGIL.....	44-45	Osteotome per plastica nasale.....	200	Pinza applicatrice RANEY.....	172	
Micro Forbici VANNAS.....	37, 42, 44-45	Osteotomi LAMBOTTE.....	194	Pinza bipolare con canale di aspirazione.....	292	
Micro Forbici YASARGIL.....	41-42, 44	Osteotomi LEXER.....	197	Pinza micro.....	65	
MICRO FRIEDMAN Pinze scorbie.....	158	Osteotomi LEXER MINI.....	197	Pinza per applicare MCKENZIE.....	170	
Micro periostotomi.....	221-222	Osteotomi MINI-LAMBOTTE.....	195	Pinza per applicare OLIVECRONA-TOENNIS.....	170	
Micro periostotomi CASPAR.....	223-224	Osteotomi STILLE.....	192	Pinza per applicare SMITHWICK.....	170	
Micro periostotomi YASARGIL.....	221-223	Osteotomo per plastica nasale.....	200	Pinza per applicare SWEET.....	170	
Micro Pinza.....	65	Osteotomo per plastica nasale COTTLE.....	200	Pinza per craniotomia CONE.....	175	
Micro Pinza Atraumatica DE BAKEY.....	66-67	P			Pinza per craniotomia DeVILBISS.....	174
Micro pinze.....	264	PAPAVERO-CASPAR Strumenti per ipofisi.....	256	Pinza-Ultra-Leggera.....	64	
Micro Pinze per legature.....	61-63	PAPAVERO-HARTMANN Strumenti per ipofisi.....	256	Pinze Atrauma Bulldog.....	77-79	
Micro Pinze per legature LAZAR.....	62	PENFIELD Dissettori.....	220	Pinze Atrauma Bulldog DE BAKEY.....	79	
Micro Pinze YASARGIL.....	74	Per dura-madre CUSHING.....	107	Pinze Atrauma Bulldog DE BAKEY-HESS.....	80	
Micro port'aghi.....	94-98	Per dura-madre DANDY.....	106	Pinze Atrauma Bulldog GLOVER.....	79-80	
Micro portaghi CASTROVIEJO.....	95	Per preparazione nervi TOENNIS-ADSON.....	27	Pinze Atraumatiche DE BAKEY.....	68	
Micro portaghi YASARGIL.....	96	P			Pinze Bulldog	
Micro-cannula d'aspirazione.....	230	PAPAVERO-CASPAR Strumenti per ipofisi.....	256	DE BAKEY-DIETHRICH Mini.....	76	
Micro-HARTMANN Pinze emostatiche.....	81	PENFIELD Dissettori.....	220	Pinze Bulldog Mini DIETHRICH.....	76	
MILLESI Micro Forbici.....	44-45	Per dura-madre CUSHING.....	107	Pinze COTTLE.....	73	
MILLIGAN Dissettori per dura-madre.....	218	Per dura-madre DANDY.....	106	Pinze da orologio.....	59-60	
MILLS Forbici vascolari.....	29	Per preparazione nervi TOENNIS-ADSON.....	27	Pinze da presa per tendini CAROLL.....	89	

Pinze da presa	Pinze per dissezione chirurgiche/ anatomiche GERALD.....	Pinze sgorbie ADSON.....
YASARGIL-NICOLA.....263	56-57	159
Pinze dilatatori vascolari.....60	Pinze per dissezione chirurgiche/ anatomiche GILLIES.....	Pinze sgorbie BACON.....
Pinze emostatiche CRILE.....83	56	162
Pinze emostatiche CRILE-RANKIN.....83	Pinze per dissezione chirurgiche/ anatomiche MAYO.....	Pinze sgorbie BANE-HARTMANN.....
Pinze emostatiche DANDY.....84	58	160
Pinze emostatiche	Pinze per dissezione chirurgiche/ anatomiche McINDOE.....	Pinze sgorbie BEYER.....
HALSTED-MOSQUITO.....82	55	161, 163
Pinze emostatiche	Pinze per dissezione chirurgiche/ anatomiche POTTS-SMITH.....	Pinze sgorbie BÖHLER.....
HALSTED-MOSQUITO Micro.....82	50	163
Pinze emostatiche HARTMANN.....81	Pinze per dissezione chirurgiche/ anatomiche SEMKEN.....	Pinze sgorbie ECHLIN.....
Pinze emostatiche KELLY.....83	56	Pinze sgorbie FRIEDMAN.....
Pinze emostatiche KELLY-RANKIN.....83	Pinze per dissezione chirurgiche/ anatomiche TAYLOR.....	Pinze sgorbie FRIEDMAN Mini.....
Pinze emostatiche	58	Pinze sgorbie FRYKHOLM.....
Micro-HARTMANN.....81	Pinze per dissezione chirurgiche/ anatomiche WANGENSTEEN.....	Pinze sgorbie JANSEN.....
Pinze guida-perforatore e proteggi dura-madre ADSON.....	58	Pinze sgorbie KLEINERT-KUTZ.....
177	Pinze per dissezione chirurgiche/ anatomiche WAUGH.....	Pinze sgorbie LEKSELL (STILLE).....
Pinze JANSEN.....73	53	166
Pinze JANSEN-GRUENWALD.....73	Pinze per ipofisi ADSON.....	Pinze sgorbie LEMPERT.....
Pinze LUCAE.....73	253	160-161
Pinze morso a forma di cucchiaio.....264	Pinze per ipofisi LANDOLT.....	Pinze sgorbie LUER.....
Pinze per afferrare tessuti HEIFETZ.....71	239	Pinze sgorbie MARQUARDT.....
Pinze per afferrare tessuti HUNT . 69-70	Pinze per la protezione del foro.....	Pinze sgorbie MAYFIELD.....
Pinze per afferrare tessuti SAMII.....72	176	Pinze sgorbie MICRO FRIEDMAN.....
Pinze per afferrare	Pinze per laminectomia.....	Pinze sgorbie OLIVECRONA.....
tessuti YASARGIL.....	CASPAR.....	Pinze sgorbie RUSKIN.....
69, 71	236-237	Pinze sgorbie SAUERBRUCH.....
Pinze per afferrare tessuti	Pinze per laminectomia CLOWARD.....	Pinze sgorbie SEMB.....
YASARGIL-SAMII.....	Pinze per laminectomia CUSHING.....	Pinze sgorbie SMITH-PETERSEN.....
71	232	Pinze sgorbie STELLBRINK.....
Pinze per aprire gli	Pinze per laminectomia	Pinze sgorbie STILLE-LUER.....
specoli LANDOLT.....	FERRIS-SMITH.....	Pinze sgorbie STILLE-RUSKIN.....
255	235	Pinze sgorbie ZAUFAL-JANSEN.....
Pinze per cuoio capelluto MARTEL.....85	Pinze per laminectomia HOEN.....	Pinze taglienti per dischi intervertebrali.....
Pinze per dissezione chirurgiche/ anatomiche ADLERKREUTZ.....	234	274-278
54	Pinze per laminectomia LANDOLT.....	Pinze taglienti per dischi intervertebrali COLCLOUGH.....
Pinze per dissezione chirurgiche/ anatomiche ADSON.....	239	278
51-52	Pinze per laminectomia	Pinze taglienti per dischi intervertebrali
Pinze per dissezione chirurgiche/ anatomiche ADSON Micro.....	LOVE-GRUENWALD.....	FERRIS-SMITH-KERRISON.....
51-52	232	274-275
Pinze per dissezione chirurgiche/ anatomiche ADSON-BROWN.....	Pinze per laminectomia	Pinze taglienti per dischi
52	OLDBERG.....	intervertebrali smontabile a fucile
Pinze per dissezione chirurgiche/ anatomiche ADSON-DE BAKEY.....	239	FERRIS-SMITH-KERRISON.....
51	Pinze per laminectomia	276
Pinze per dissezione chirurgiche/ anatomiche BROPHY.....	SCHLESINGER.....	Pinze taglienti per dischi intervertebrali
54	233	smontabile a fucile superficiale
Pinze per dissezione chirurgiche/ anatomiche BROWN Micro.....	Pinze per laminectomia SPURLING.....	antireflesso nera FERRIS-SMITH-
53	232	KERRISON.....
Pinze per dissezione chirurgiche/ anatomiche CUSHING.....	Pinze per laminectomia WAGNER.....	275, 277
53	235	Pinze-Punzoni.....
Pinze per dissezione chirurgiche/ anatomiche CUSHING-TAYLOR.....	Pinze per laminectomia	Pinze-Punzoni CITELLI.....
57	WEIL-BLAKESLEY.....	280
Pinze per dissezione chirurgiche/ anatomiche DUEHRSEN.....	Pinze per laminectomia YASARGIL.....	Pinze-Punzoni
55	239	HAJEK-KOFLER.....
	Pinze per legature Micro.....	279-280
	61-63	Pinze-Punzoni KERRISON.....
	Pinze per preparazione	279
	e per legatura ADSON BABY.....	Pistoni CASPAR.....
	86	191
	Pinze per preparazione	PLESTER Divaricatori
	e per legatura FUCHSIG.....	autostatici.....
	86	120, 122
	Pinze per preparazione	PLESTER Tubi aspirazioni.....
	e per legatura GEMINI.....	229
	87	Port'aghi BAUMGARTNER.....
	Pinze per preparazione	Port'aghi CRILE-WOOD.....
	e per legatura MIXTER BABY.....	92
	88	Port'aghi DE BAKEY.....
	Pinze serrafina DIEFFENBACH.....	93
	81	Port'aghi HALSEY.....
	Pinze serrafina JOHNS-HOPKINS.....	92

Port'aghi MAYO-HEGAR.....	93
port'aghi Micro.....	94-98
Port'aghi NEIVERT.....	92
Port'aghi RYDER.....	93
Porta-fermagli.....	170
Portaghi BARRAQUER Micro.....	94
POTTS-DE MARTEL	
Forbici vascolari.....	29
POTTS-SMITH Forbici vascolari ...	30-31
POTTS-SMITH Pinze per dissezione chirurgiche/anatomiche.....	50
POTTS-YASARGIL Micro Forbici ..	44-45
Punta trapano MICHELE.....	180

Q

QUERVAIN Elevatori.....	204
-------------------------	-----

R

RALK Perforatori a mano.....	283
RANEY Pinza applicatrice.....	172
Raspatore LANDOLT-REULEN.....	262
Raspatore NICOLA.....	257
Raspatorio con aspiratore GUILÉN.....	230
REDA Curette taglienti.....	186-187
REDA manico per sega.....	173
REDA Perforatori a mano.....	283
REDA Rompi lama di rasoio.....	17
REYNOLDS Forbici per dissezione.....	26
RHOTON Dissettore.....	250
RHOTON Gancio.....	250
RHOTON Periostotomi.....	250
RHOTON Sonda bottonute.....	250
RHOTON spatulate.....	250
ROGER Elevatori.....	216
Rompi lama di rasoio	
CASTROVIEJO.....	17
Rompi lama di rasoio REDA.....	17
Rompi lama di rasoio	
TROUTMAN-CHRIS.....	17
RUSKIN Pinze sgorbie.....	164
RUSKIN-LISTON Cesioie	
per ossa.....	168
RYDER Port'aghi.....	93

S

SACHS Dissettori per dura-madre.....	217
SACHS Unicini per nervi.....	108
SAMII Coltelli lanceolari.....	246
SAMII Coltelli per tumori.....	245-246
SAMII Pinze per afferrare tessuti.....	72
SAUERBRUCH Costotomi.....	48

SAUERBRUCH Pinze sgorbie.....	166
SAUERBRUCH-FREY Costotomi.....	48
SCALP-CONTOUR Divaricatore autostatico per cuoio capelluto.....	125
Scalpellini LEXER.....	197
Scalpellini LEXER MINI.....	197
Scalpellini STILLE.....	192
SCHLESINGER Pinze per laminectomia.....	233
SCHMIEDEN-TAYLOR Forbici per dura-madre.....	34
SCOVILLE Curette taglienti.....	183
SCOVILLE Divaricatori per laminectomia.....	135
SCOVILLE Uncini per le radici dei nervi.....	109, 112
SCOVILLE-HAVERFIELD Divaricatori per laminectomia.....	135
SCOVILLE-RICHTER Divaricatori per laminectomia.....	136
SEBILEAU Elevatori.....	204
SEDILLOT Elevatori.....	204
SEDILLOT Periostotomi.....	203
Sega OLIVECRONA.....	173
SELDIN Periostotomi.....	207
SEMB Cesioie per ossa.....	169
SEMB Pinze sgorbie.....	167
SEMKEN Pinze per dissezione chirurgiche/anatomiche.....	56
Separatori per vertebre CLOWARD.....	147, 149
Separatori per vertebre INGE.....	148
SEWALL Elevatori.....	215
Sgorbia BOIES.....	207
Sgorbia COBB.....	196
Sgorbie.....	192-193, 196-199
Sgorbie per la colonna vertebrale CAPENER.....	199
Sgorbie SMITH-PETERSEN.....	193
Sgorbie STILLE.....	192
Sgorbie ZIELKE.....	198
Sistema di distrazione vertebrale.....	156
Sistema di distrazione vertebrale cervicale.....	154-155
Sistema di distrazione vertebrale cervicale CASPAR.....	154
Sistema di fissaggio LEYLA.....	268-272
Sistema di fissaggio YASARGIL.....	268-272
SMITH-PETERSEN Pinze sgorbie.....	162
SMITH-PETERSEN Sgorbie.....	193
SMITHWICK Pinza per applicare.....	170
SMITHWICK Unicini per nervi.....	108

Sonda bottonuta JACOBSON.....	243
Sonda Conduttrice a forchetta CASPAR.....	247
Sonda Conduttrice a forchetta JACOBSON.....	247
Sonda doppia JACOBSON.....	243
Sonde bottonute RHOTON.....	250
Sostegno osseo e impattatore CASPAR.....	190
Spatola forma a forchetta HOSOBUCHI.....	259
Spatole cerebrali AACHEN.....	266
Spatole cerebrali CUSHING.....	266
Spatole cerebrali DAVIS.....	267
Spatole cerebrali HEIFETZ.....	267
Spatole cerebrali OLIVECRONA.....	266
Spatulate RHOTON.....	250
Specolo per ernia discale lombare CASPAR.....	151
SPINAL Curette taglienti.....	182
SPRATT Curette taglienti.....	180
SPURLING Pinze per laminectomia.....	232
STAMM Cesioie per ossa.....	168
STANDARD Forbici per chirurgia.....	20
STELLBRINK Pinze sgorbie.....	158
STEVENS Forbici delicate.....	28
STILLE Osteotomi.....	192
STILLE Scalpellini.....	192
STILLE Sgorbie.....	192
STILLE-HORSLEY Cesioie per ossa.....	169
STILLE-LISTON Cesioie per ossa.....	169
STILLE-LUER Pinze sgorbie.....	165
STILLE-RUSKIN Pinze sgorbie.....	165
STRULLY forbici per neurochirurgia.....	33
strumenti introduttori DeMARTEL.....	173
Strumenti per esaminare e misurare ...	11
Strumenti per ipofisi.....	255-264
Strumenti per ipofisi CUSHING-LANDOLT.....	255
Strumenti per ipofisi HARDY.....	258, 261
Strumenti per ipofisi LANDOLT.....	256, 259
Strumenti per ipofisi NICOLA.....	257
Strumenti per ipofisi PAPAVERO-CASPAR.....	256
Strumenti per ipofisi PAPAVERO-HARTMANN.....	256
SWEET Pinza per applicare.....	170

T

Taglienti VOLKMANN.....	180
-------------------------	-----

TAYLOR Divaricatori	
per laminectomia	135
TAYLOR Divaricatori spinali	105
TAYLOR Pinze per dissezione chirurgiche/anatomiche	58
TAYLOR USA Mod Martelli da percussione	8
TOENNIS Dissettori per dura-madre	217
TOENNIS-ADSON per preparazione nervi	27
Trapano cranico GALT	177
Trapano CUSHING	282
Trapano ERRICO	282
Trapano MC KENZIE	282
TRAVERS Divaricatori autostatici	123
TROEMNER Martelli da percussione	8
TROUTMAN-CHRIS Rompi lama di rasoio	17
Tubi aspirazioni	226-230
Tubi aspirazioni ADSON	226
Tubi aspirazioni BARON	226
Tubi aspirazioni FERGUSSON	226-227
Tubi aspirazioni FRAZIER/FERGUSSON	227
Tubi aspirazioni HOUSE	229
Tubi aspirazioni PLESTER	229
Tubi aspirazioni WULLSTEIN	230
Tubi aspirazioni YASARGIL	228
Tubi aspirazioni ZÖLLNER	228

U

Uncinetti FISCH Micro	115
Uncini galea YASARGIL	112
Uncini per esplorazione e coagulazione CASPAR	113
Uncini per le radici dei nervi CASPAR	110
Uncini per le radici dei nervi D'ERRICO	111
Uncini per le radici dei nervi HESS	109
Uncini per le radici dei nervi HOLSHER	109
Uncini per le radici dei nervi LOVE	111-112
Uncini per le radici dei nervi SCOVILLE	109, 112
Uncini per nervi e vasi KRAYENBÜHL	114
Uncini per pelle FRAZIER	100
Uncini per pelle FREER	100

Uncini per pelle GILLIES	100
Uncini per pelle JOSEPH	100
Uncini per tessuti	249
Uncino dura madre FISCH	243
Uncino molto fino FISCH	243
Uncino smusso LANDOLT	259
Uncini per nervi ADSON	108
Uncini per nervi CRILE	107
Uncini per nervi DANDY	106
Uncini per nervi GRAHAM	108
Uncini per nervi SACHS	108
Uncini per nervi SMITHWICK	108
UNIVERSAL Forbici per filo di metallo e lamiera	34

V

Valve per divaricatori cervicale ..	142-143
VANNAS Micro Forbici	37, 42, 44-45
VOLKMANN Curette taglienti	188
VOLKMANN taglienti	180

W

WAGNER Martelli	10
WAGNER Periostotomi	213
WAGNER Pinze per laminectomia	235
WALTON Divaricatori per laminectomia	133
WANGENSTEEN Pinze per dissezione chirurgiche/anatomiche	58
WARTENBERG Algesimetro	11
WATSON-CHEYNE Elevatori	215
WAUGH Pinze per dissezione chirurgiche/anatomiche	53
WEIL-BLAKESLEY Pinze per laminectomia	238
WEITLANER Divaricatori autostatici ..	119
WEITLANER-WULLSTEIN Divaricatori autostatici	119
WILLIAMS Divaricatori per emilaminectomia	145
WILLIGER Martelli	9
WILLIGER Periostotomi	206
WOODSON Dissettori per dura-madre	219
WULLSTEIN Divaricatori autostatici ..	120
WULLSTEIN Tubi aspirazioni	230

Y

YASARGIL Conduttori per legature ..	114
YASARGIL Forbici per dissezione .	41-42
YASARGIL Forchetta per tumori	248

YASARGIL Micro coltelli per vasi	242
YASARGIL Micro curette	189
YASARGIL Micro Forbici	41-42, 44
YASARGIL Micro periostotomi ..	221-223
YASARGIL Micro Pinze	74
YASARGIL Micro portaghi	96
YASARGIL Pinze per afferrare tessuti	69, 71
YASARGIL pinze per laminectomia ..	239
YASARGIL Sistema di fissaggio	268-272
YASARGIL Tubi aspirazioni	228
YASARGIL Uncini galea	112
YASARGIL-NICOLA Pinze da presa	263
YASARGIL-SAMII Pinze per afferrare tessuti	71

Z

ZAUFAL-JANSEN Pinze sgorbie	163
ZIELKE sgorbie	198
ZÖLLNER Tubi aspirazioni	228



Maltepe Mah.Eski ırpıcıyolu Sk.
Merter İş Merkezi D Blok 2/21
034234- Zeytinburnu, İstanbul

+90 212 482 71 52
info@redamed.com