

HNO/SINUSKOPIE
ENT/SINUSCOPY
ORL/SINUSCOPIÁ

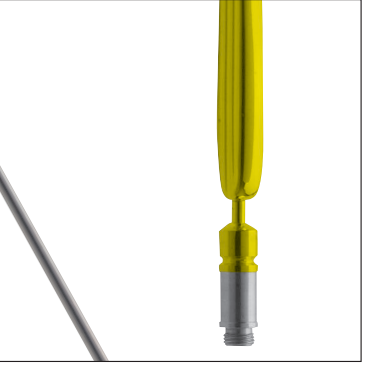



Maltepe Mah.Eski ırpıcıyolu Sk.
Merter İş Merkezi D Blok 2/21
034234- Zeytinburnu, İstanbul

+90 212 482 71 52
info@redamed.com

Charrière (Ch) French (F)	Durchmesser in mm	Inches
1	0,33	0,013
2	0,67	0,025
3	1,00	0,039
4	1,33	0,051
5	1,67	0,065
6	2,00	0,0787
7	2,33	0,092
8	2,67	0,105
9	3,00	0,1181
10	3,33	0,131
11	3,67	0,144
12	4,00	0,1575
13	4,33	0,170
14	4,67	0,184
15	5,00	0,1968
16	5,33	0,210
17	5,67	0,223
18	6,00	0,2362
19	6,33	0,249
20	6,67	0,263
21	7,00	0,2756
22	7,33	0,288
23	7,67	0,302
24	8,00	0,3150
25	8,33	0,328
26	8,67	0,341
27	9,00	0,3543
28	9,33	0,367
29	9,67	0,380
30	10,00	0,3973
31	10,33	0,407
32	10,67	0,420
34	11,33	0,446
36	12,00	0,4724
38	12,67	0,494
40	13,33	0,5199
45	15,00	0,5905

Gauge (G)	Durchmesser in mm	Inches
35	0,13	0,005
34	0,18	0,007
33	0,20	0,008
32	0,23	0,009
31	0,25	0,010
30	0,30	0,012
29	0,33	0,013
28	0,36	0,014
27	0,41	0,016
26	0,46	0,018
25	0,51	0,020
	0,53	0,021
24	0,56	0,022
23	0,64	0,025
22	0,71	0,028
21	0,81	0,032
20	0,89	0,035
	0,97	0,038
19	1,07	0,042
18	1,27	0,050
17	1,50	0,059
16	1,65	0,065
15	1,83	0,072
14	2,11	0,083
13	2,41	0,095
12	2,77	0,109
11	3,05	0,120
10	3,40	0,134
9	3,76	0,148
8	4,19	0,165
7	4,57	0,180
6	5,16	0,203

1 OZ	0,028 ml
5 OZ	0,140 ml
16 OZ	0,450 ml

35 OZ	1,0 l
128 OZ	3,7 l

GARANTIE / WARRANTY / GARANTIA

GARANTIE

Wir gewähren auf alle **Reda**-Instrumente 5 Jahre Garantie. Voraussetzung ist der sach- und fachgerechte Einsatz der Instrumente. Von der Garantie sind Verschleißerscheinungen ausgeschlossen.

WARRANTY

Our **Reda** products are free from manufacturing defects in material and workmanship. We therefore give on all instruments a guarantee of five years provided that the instruments are maintained and cleaned properly and used normally for their intended purpose.

GARANTIA

Estamos convencidos de nuestra calidad y concedemos a todos los instrumentos de **Reda** 5 años de garantía contra cualquier defecto de fabricación, siempre y cuando se usen adecuadamente. De la garantía excluimos la manifestación de desgaste.

Arbeitsanweisung **Aufbereitung (Reinigung) und Sterilisation von resterilisierbaren** **chirurgischen Instrumenten**

DIN EN ISO 17664:2004 (D)

Hersteller:
REDA Instrumente GmbH, Gänsäcker 34
78532 Tuttlingen

Alle von Reda gelieferten wieder verwendbaren Instrumente wurden ausschließlich für den chirurgischen Gebrauch konstruiert und dürfen zu keinen anderen Zwecken benutzt werden. Unsachgemäße Handhabung und sorglose Pflege sowie zweckentfremdeter Gebrauch können zu vorzeitigem Verschleiß der Instrumente führen. Die Produkte sind bei der Auslieferung nicht sterilisiert.

Reinigungsvorbereitung

Fabrikneue Instrumente müssen vor der ersten Anwendung den gesamten Aufbereitungsprozess durchlaufen. Instrumente unmittelbar nach Anlieferung aus den Folienverpackungen entnehmen und in trockenen Räumen bei gleichbleibender Raumtemperatur luftoffen lagern, um Kondensationsbildung zu vermeiden.

Die Instrumente keinen Sonnenlichteinstrahlungen oder Dämpfen durch Chemikalien (Säuren oder scharfe Reinigern) aussetzen.

Vor der ersten Sterilisation alle Schutzkappen und Folien vollständig entfernen und anschließend reinigen.

Gebrauchte Instrumente unmittelbar nach Beendigung des Eingriffs von Blut, Gewebe und Arzneimittel reinigen. Instrumente in eine freigegebene Lösung eines kombinierten Reinigungs- und Desinfektionsmittels, das keine proteinfixierende Wirkung besitzt, einlegen.

Dosierung des Herstellers beachten. Nicht in NaCl Lösung einlegen, ansonsten Gefahr für Loch- bzw. Spannungsriss-Korrosion

Überfüllung von Instrumentensieben und Wasch-Trays vermeiden.

Gelenkinstrumente vor dem Aufbereiten öffnen. Zerlegbare Instrumente gemäß Bedienungsanleitung (Piktogramm) zur Reinigung zerlegen. Reinigungsgerechtes Zubehör verwenden. Für die manuelle Reinigung nie Metallbürsten oder Metallschwämme verwenden.

Spülmaschinen und Ultraschallanlagen nicht überladen. Spül- oder Schallschatten vermeiden. Dosierung, Einwirkzeit und Einwirktemperatur bei der Desinfektion und Reinigung unbedingt einhalten. Nach der Reinigung sorgfältig spülen. Möglichst vollentsalztes (demineralisiertes) Wasser verwenden.

Nach dem Spülen ausreichend trocknen.

Abgenutzte, korrodierte, deformierte, poröse oder anderweitig beschädigte Instrumente aussortieren.

Aus hygienischen Gründen müssen Instrumente, die zur Reparatur eingesandt werden komplett aufbereitet werden.

Gelenkinstrumente nach jeder Aufbereitung mit einem Pflegemittel auf Basis von Paraffinöl behandeln (gilt nicht für flexible Endoskope und Zubehör).

Funktionsprüfung in zusammengebautem Zustand durchführen.

Instrumente mit Rastensperre vor der Sterilisation nur im ersten Zahn schließen.

Als Sterilisationsverfahren empfehlen wir die Dampfsterilisation (üblicherweise mit Sattedampf bei 134° C)

Sterilisation ist kein Ersatz für Sauberkeit!

Die Broschüre "Instrumenten-Aufbereitung richtig gemacht" des Arbeitskreis Instrumenten-Aufbereitung dient als Anhalt.

Reda Instrumente GmbH
78532 Tuttlingen

IMPORTANT INFORMATION CONCERNING PREPARING AND STERILIZING SURGICAL INSTRUMENTS

Dear Sirs,
please read the following instructions very carefully before using the instruments.

1. INITIAL USE

All instruments which are being used for the first time must be thoroughly cleaned, rinsed and then sterilized before using.

2. TREATING INSTRUMENTS AFTER USAGE

- a.) The instruments might be immediately thoroughly cleaned and disinfected. Please follow the manufacturer's instructions when using cleaning agents and disinfectants.
- b.) Instruments which may be dismantled must be cleaned and disinfected after being taken apart.
- c.) Cleaning may be carried out either manually or with a machine. Care should be taken that only cleaning agents and disinfectants are used, which are changed daily.
- d.) Following chemical disinfection and manual cleaning, all instruments must always be thoroughly rinsed under running water.
- e.) The temperature of water used in a machine for cleaning should not exceed 45°C.
- f.) Whether cleaning is carried out manually or by machine, we especially ask you to ensure that the correct dosage for cleaning solutions or the correct combination of disinfectant and cleaning solution, is employed. Similar importance should be applied to the length of time the agents require to perform properly and to the temperature set.
- g.) Hinged instruments should be opened before cleaning.
- h.) Please ensure that the perforated instrument trays, when loaded, do not exceed 10 kg in weight.
- i.) Please take care that when instruments are being cleaned they are arranged proper in a manne that fluids can circulate freely.
- j.) Deposits remaining after the cleaning process must be completely removed in the first rinse which now follows. The optimum temperature for final rinsing has proved to be between 70° and 90° C. Please use only purified water in this final cleaning stage.
- k.) The instruments must be carefully dried after cleaning and rinsing is completed.
- l.) Moving parts and the cutting edges of shears and scissors must be treated with preservatives which are both suitable and physiologically safe.

3. TESTING FOR CORRECT FUNCTIONING

- a.) Instruments must be carefully and thoroughly checked before every occasion that they are used.

- b.) After each time they are cleaned, the instruments must be macroscopically clean, i.e., visibly free from proteinbased residues and other soiling.
- c.) Care should be taken so that cracks, breakages and corrosion are noticed.
- d.) Instruments with flecks should be separated and taken out for special treatment.
- e.) All moving parts as well as working tips and blades should be checked with special care.
- f.) Checking should be carried out according to the extent to which the instruments will be used.
- g.) Instruments which are in any way defective or damaged should be immediately sorted out from the others.

4. STERILIZATION

- a.) All stainless steel surgical instruments supplied by us may be sterilized in an autoclave.
- b.) Please follow the manufacturer's operating instructions when using autoclave. All machines used must comply with all current quality and other standards.
- c.) Instruments are being sterilized/ autoclaved at a temperature of 134°C.
- d.) Sterilization packing material must comply with all current standards.
- e.) Instruments with ratchets or self-retaining mechanisms should be sterilized opened or in the first ratchet position.
- f.) Please ensure that perforated instrument trays, when loaded do not exceed 10 kg in weight.

5. IN GENERAL

- a.) All surgical instruments supplied by us have been thoroughly inspected before dispatch and leave our factory in perfect condition. Damage which can arise as a result of transporting, cleaning, preserving, sterilizing or storing, must be prevented.
- b.) Please handle surgical instruments always with the utmost care.
- c.) Instruments must be stored in a clean and dry place.
- d.) If you have any queries or problems please contact us at any time:

We should like to point out that, if the above-mentioned directions are not followed or the instruments supplied by us are not properly used, all guarantee claims become void and any consequences must be borne by yourselves.

SUGERENCIAS PARA LA LIMPIEZA, ESTERILIZACIÓN Y MANTENIMIENTO DE INSTRUMENTOS QUIRÚRGICOS

ENJUAGADO

Tras el uso enjuagar enseguida los instrumentos bajo un chorro de agua caliente (no hirviendo). El enjuagado debe servir para quitar los residuos de sangre, mucosas y tejidos.

LIMPIEZA

Si la limpieza no se efectúa inmediatamente después del enjuagado, los instrumentos tienen que sumergirse en una solución de agua y detergente con PH neutro (7)

Para los instrumentos muy delicados (algunos tipos de porta agujas o tijeras se aconseja una limpieza manual: ver punto "C").

a.- Limpieza en la pila de ultrasonido

Los instrumentos tienen que estar en la pila el tiempo necesario recomendado por el fabricante para efectuar el ciclo del lavado, generalmente de 5 a 10 minutos.

Los instrumentos con bisagras o juntas (articulaciones) tienen que sumergirse en la pileta en posición abierta.

Asegurarse de que las hojas afiladas de las tijeras, bisturís para gingivectomía, curetas, etc. no estén en contacto con otros instrumentos.

Todos los instrumentos deben estar completamente sumergidos en la solución de lavado.

No poner instrumentos de diferentes metales (acero inoxidable, instrumentos cromados, latón, etc.) en el mismo ciclo de lavado.

Cambiar a menudo la solución para el lavado, como mínimo todas las veces que lo recomienda el fabricante de la pila de ultrasonidos.

Enjuagar concienzudamente los instrumentos con agua corriente tras lavado con ultrasonidos para quitar los residuos de la solución de lavado.

b.- Limpieza con lavadora

Seguir las indicaciones del fabricante. Asegurarse de que los instrumentos hayan sido lubricados tras el último ciclo de lavado y antes del ciclo de esterilización.

c.- Limpieza manual

La mayor parte de los fabricantes de instrumentos indican el lavado con los ultrasonidos como el modo mejor y más eficaz para limpiar los instrumentos quirúrgicos, especialmente los que tienen bisagras, cierres y en general articulaciones. Si la limpieza con los ultrasonidos no es posible, se aconseja usar el método siguiente:

- Usar cepillos rígidos de plástico, nylon, etc.
- Cepillar concienzudamente los instrumentos más delicados y, si es posible, enjuagar, limpiar y esterilizar estos instrumentos separadamente.
- Verificar que toda la superficie de estos instrumentos esté limpia.
- Tras haber cepillado los instrumentos, enjuagarlos bajo el chorro de agua corriente.
- Durante el enjuagado abrir y cerrar las tijeras, las pinzas hemostáticas, los porta agujas y los demás instrumentos con bisagras o juntas y asegurarse de que las partes internas de las bisagras estén perfectamente enjuagadas como la superficie externa del instrumento.

SECADO, LUBRIFICACIÓN E INSPECCIÓN

Tras las operaciones de limpieza y de enjuagado, los instrumentos quirúrgicos tienen que ser secados perfectamente.

Todos los instrumentos con juntas o bisagras (acción "metal contra metal") como tijeras, pinzas hemostáticas, porta agujas, fórceps de extracción, etc., tienen que ser lubricados. Se aconsejan lubricantes específicos para el instrumental quirúrgico. No usar aceites o lubricantes industriales.

A este punto es buena norma inspeccionar el estado de cada instrumento y verificar el funcionamiento según el uso específico. Controlar y asegurarse de que:

- Las hojas de las tijeras estén lisas de arriba abajo y de que, una vez cerradas, no hagan juego. Probar las tijeras cortando gasa muy fina. Tres cuartas parte de la hoja tienen que cortar la gasa sin retenerla.

- Las puntas de las pinzas estén al mismo nivel.
- Las pinzas hemostáticas y los porta agujas no dejen pasar la luz entre las puntas cuando estén cerradas, se abran y cierren fácilmente y que las bisagras no estén demasiado flojas.
- Controlar el desgaste de la porta agujas sobre la superficie interna de las puntas.
- Las cánulas metálicas de aspiración estén bien limpias en su interior.
- Los instrumentos cortantes y los bisturís tengan las hojas bien afiladas y no estropeadas.

ESTERILIZACIÓN EN AUTOCLAVE

Tras haber enjuagado, limpiado, secado, lubricado e inspeccionado los instrumentos, éstos pueden ser preparados para la esterilización separadamente o en serie.

Instrumentos individuales:

Las bolsas especiales monouso son el ideal para contener los instrumentos. Asegurarse de que las bolsas que contendrán los instrumentos con cierres y articulaciones (pinzas hemostáticas, porta agujas, etc.) sean lo bastante grandes como para contener los citados instrumentos en posición abierta.

Instrumentos en serie:

Poner los instrumentos en los especiales cestos o bandejas de acero inoxidable. Poner los instrumentos más pesados en la parte inferior cuando sean necesarias varias bandejas.

No cerrar nunca los instrumentos durante el ciclo en autoclave. Un instrumento cerrado no estará nunca bien esterilizado, ya que el vapor no puede penetrar en la parte de cierre a contacto "metal contra metal". En el instrumento podría además romperse en la parte de la bisagra a causa de la expansión del metal debida al calor durante el ciclo del autoclave.

No cargar demasiado la cámara del autoclave ya que algunos instrumentos podrían formar "zonas de sombra" sobre otros en los que el vapor no penetraría.

ATENCIÓN

Al final del ciclo de esterilización - antes del ciclo de secado- abrir ligeramente la portezuela del autoclave y preceder con el ciclo desecado según las instrucciones del fabricante. Si la portezuela del autoclave se abre completamente antes del ciclo de secado, el aire frío de la habitación entraría en la cámara del autoclave causando la formación de condensación sobre los instrumentos y de consecuencia aparecerían las manchas de agua que vemos a menudo en los mismos.

ESTERILIZACIÓN EN FRÍO:

La mayor parte de las soluciones para la esterilización en frío esterilizan los instrumentos completamente tras 10 horas de inmersión. Esta acción química prolongada puede ser más perjudicial para los instrumentos que el ciclo normal de 20 minutos en autoclave.

Si los instrumentos tienen necesidad de ser simplemente "desinfectados", el proceso en frío es adecuado, ya que la desinfección tiene lugar en 10 minutos solamente.

Recuerde bien la diferencia entre:

ESTÉRIL - término absoluto (ningún organismo logra sobrevivir) y

DESINFECTADO - perfectamente limpio.

Usen siempre la técnica más adecuada de esterilización/limpieza de los instrumentos según el uso que se haga posteriormente de ellos.

Recuerden que la esterilización de los instrumentos no sustituye la limpieza de los mismos.

Recomendamos no volver a usar ni esterilizar los artículos de un solo uso.

Si se tratan en el modo correcto los instrumentos construidos con las modernas aleaciones inoxidables pueden durar muchos años.

REINIGUNG, PFLEGE UND STERILISATION
CLEANING, CARE AND STERILIZATION
LIMPIEZA, MANTENIMIENTO Y ESTERILIZACION

ENDOSKOPE 13 - 20
ENDOSCOPES
ENDOSCOPIOS

STIRNLAMPEN 21 - 28
HEAD LIGHTS
LÁMPARAS FRONTALES

BOHRER 29 - 32
BURRS
BROCAS

HOCHFREQUENZ-CHIRURGIE 33 - 46
HIGH FREQUENCY SURGERY
CIRUGIA DE ALTA FRECUENCIA

OTOLOGIE UND OHR-MIKROCHIRURGIE 47 - 138
OTOLOGY AND EAR MICROSURGERY
OTOLOGÍA Y MICRO CIRUGIA PARA OIDO

RHINOLOGIE - SINUSKOPIE 139 - 266
RHINOLOGY - SINUSCOPY
RINOLOGÍA - SINUSCOPIA

ADENOTOMIE UND TONSILLEKTOMIE 267 - 312
ADENOTOMY AND TONSILLECTOMY
ADENOTOMÍA Y TONSILECTOMÍA

TRACHEOTOMIE	313 - 320
TRACHEOTOMY	
TRAQUEOTOMÍA	
<hr/>	
LARYNGOSKOPIE UND ENDOLARYNGEALE MIKROCHIRURGIE	321 - 354
LARYNGOLOGY AND ENDOLARYNGEAL MICROSURGERY	
LARINGOSCOPIA Y MICRO CIRUGIA ENDOLARINGEAL	
<hr/>	
BRONCHOSKOPIE	355 - 356
BRONCHOSCOPY	
BRONCOSCOPIA	
<hr/>	
INSTRUMENTENSÄTZE	357- 372
INSTRUMENT SETS	
JUEGOS DE INSTRUMENTOS	
<hr/>	
NUMMERNVERZEICHNIS	373 - 384
NUMERICAL INDEX	
INDICE NUMERICO	
<hr/>	
ALPHABETISCHER INDEX	385 - 419
ALPHABETICAL INDEX	
INDICE ALFABETICO	
<hr/>	

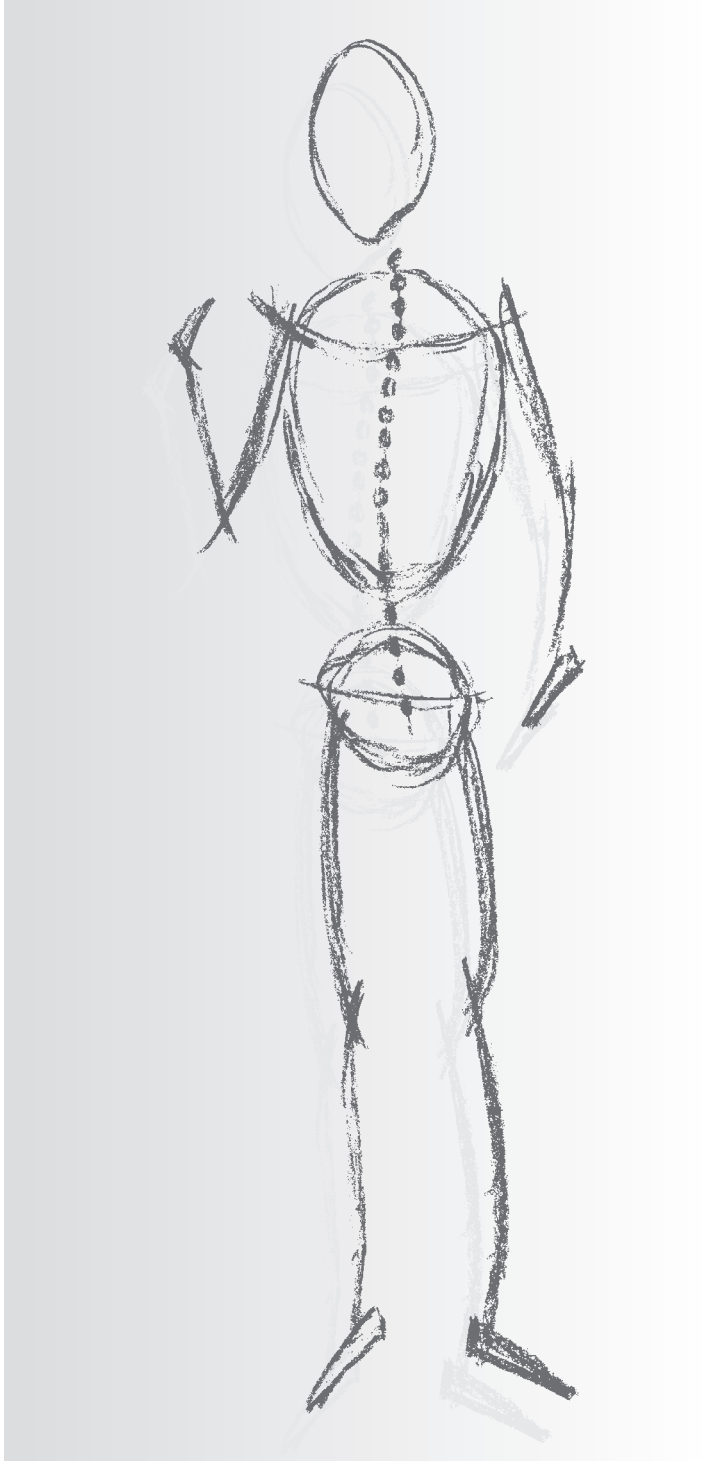

Reda Instrumente GmbH
Gänsäcker 34 - P.O. Box 131
D-78532 Tuttlingen

ENDOSKOPE

ENDOSCOPES

ENDOSCOPIOS

Ultra-slim Nasolaryngoskop
 Ultra-slim Nasolaryngoscope
 Nasolaringoscopia Ultra-slim



R805-130402-034

300 mm Nutzlänge / working length / largo útil

3,4 mm Durchmesser / diameter / diametro

130°	aufwärts / abwärts up / down hacia arriba / hacia abajo	Schwenkbereich des distalen Endes Bending range of distal tip distal final girable
------	---	--

0°	Blickwinkel / direction of view / direccion de vista
----	--

Endoskope / Optische Zange
 Endoscopes / Optical Forceps
 Endoscopios / Pinza optica

autoklavierbar / autoclavable / autoclavable
 max. 134°C, 2,3 bar

Sinuskop - Sinuscope - Sinuscopio



Ø 2,7 mm, 175 mm

R400-027175-000 0°
 R400-027175-030 30°
 R400-027175-070 70°

Ø 4,0 mm, 175 mm

R400-040175-000 0°
 R400-040175-030 30°
 R400-040175-045 45°
 R400-040175-070 70°

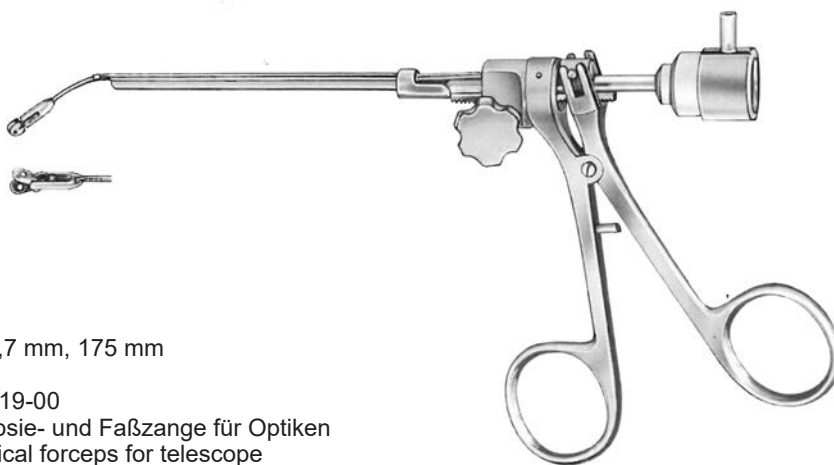

Ø 2,7 mm, 175 mm

47319-00
 Biopsie- und Faßzange für Optiken
 Optical forceps for telescope
 Pinza optica de biopsia y agarre

Endoskope
Endoscopes
Endoscopios

autoklavierbar / autoclavable / autoclavable
max. 134°C, 2,3 bar

Pharyngoskop - Pharyngoscope - Faringoscopio

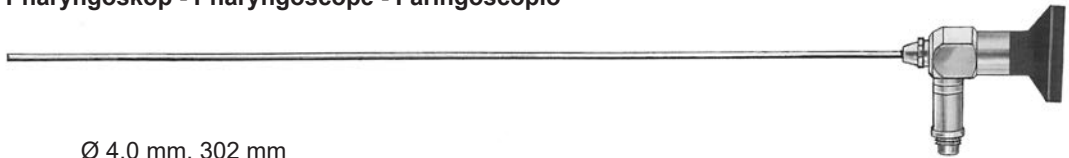

Ø 4,0 mm, 302 mm

R300-040302-000	0°
R300-040302-030	30°
R300-040302-070	70°

autoklavierbar / autoclavable / autoclavable
max. 134°C, 2,3 bar

Otoskop - Otoscope - Otopscopio

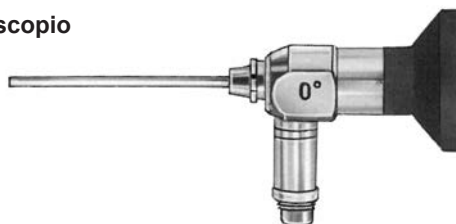

Ø 2,7 mm, 41 mm

R501-027041-000 0°

R501-027041-030 30°

Ø 4,0 mm, 50 mm

R501-040050-000 0°

R501-040050-030 30°

Laryngoskop - Laryngoscope - Laringoscopio



Ø 10 mm, 147,5 mm

R503-100148-070 70°

Ø 11 mm, 145 mm

R503-110145-090 90°

Ø 10 mm, 173 mm

R503-100173-070 70° mit Lichtleiter / integrated light cable / con portador de luz

Ø 11 mm, 173 mm

R503-110173-090 90° mit Lichtleiter / integrated light cable / con portador de luz

Endoskope
Endoscopes
Endoscopios

autoklavierbar / autoclavable / autoclavable
max. 134°C, 2,3 bar

**Endoskop zur endolaryngealen Mikrochirurgie
Endoscope for endolaryngeal microsurgery
Endoscopio para microcirurgia endolaringeal**

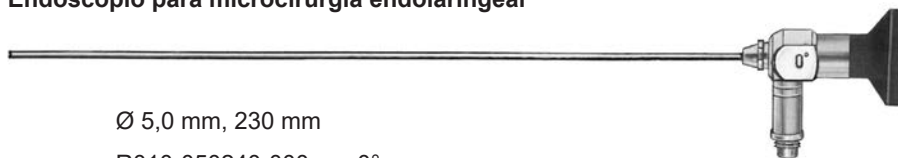

Ø 5,0 mm, 230 mm

R010-050240-000 0°

R010-050240-030 30°

R010-050240-070 70°

Bronchoskop - Bronchoscope - Broncoscopio

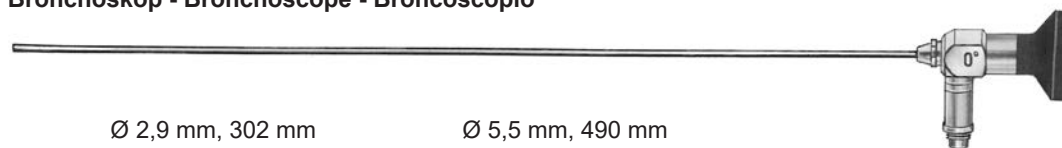

Ø 2,9 mm, 302 mm

R010-030302-000 0°

R010-030302-030 30°

Ø 5,5 mm, 490 mm

R010-055490-000 0°

R010-055490-030 30°

Fiberglas-Lichtkabel ohne Adapter
 Light Guide Cables without Adapters
 Cable de fibra optica sin adaptadores



verklebt für Halogen Licht bonded for Halogen Light para luz halogena	Ø	cm	verschmolzen für Xenon Licht fused for Xenon Light para luz Xenon
R900-035180-00	3,5	180	R901-035180-00
R900-035230-00	3,5	230	R901-035230-00
R900-035300-00	3,5	300	R901-035300-00
R900-035350-00	3,5	350	R901-035350-00
R900-048180-00	4,8	180	R901-048180-00
R900-048230-00	4,8	230	R901-048230-00
R900-048250-00	4,8	250	R901-048250-00
R900-048300-00	4,8	300	R901-048300-00
R900-048350-00	4,8	350	R901-048350-00

Adapter
Adapters
Adaptadores



Adapter zu Lichtquelle
Adapters to light source
Adaptador a la fuente de luz

INNEN - IN - INTERIOR



R900-000000-01
Storz / Aesculap



R900-000000-11
Fuji



R900-000000-03
Wolf / Henke Sass /
Dyonics / Medicon /
Comeg



R900-000000-13
Heine-Optotechnik



R900-000000-05
ACM / British /
Codman

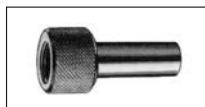

R900-000000-15
Winter+IBE



R900-000000-07
Olympus



R900-000000-21
MLW

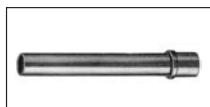

R900-000000-09
Pentax

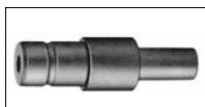

R900-000000-31
Volpi / Schöilly /
RFO



Adapter zu Endoskope
Adapter to Endoscope-side
Adaptador al endoscopio

AUSSEN - OUT - EXTERIOR



R900-000000-02
Storz / Winter+IBE /
Aesculap / Olympus



R900-000000-06
ACM / British /
Codman



R900-000000-04
Wolf

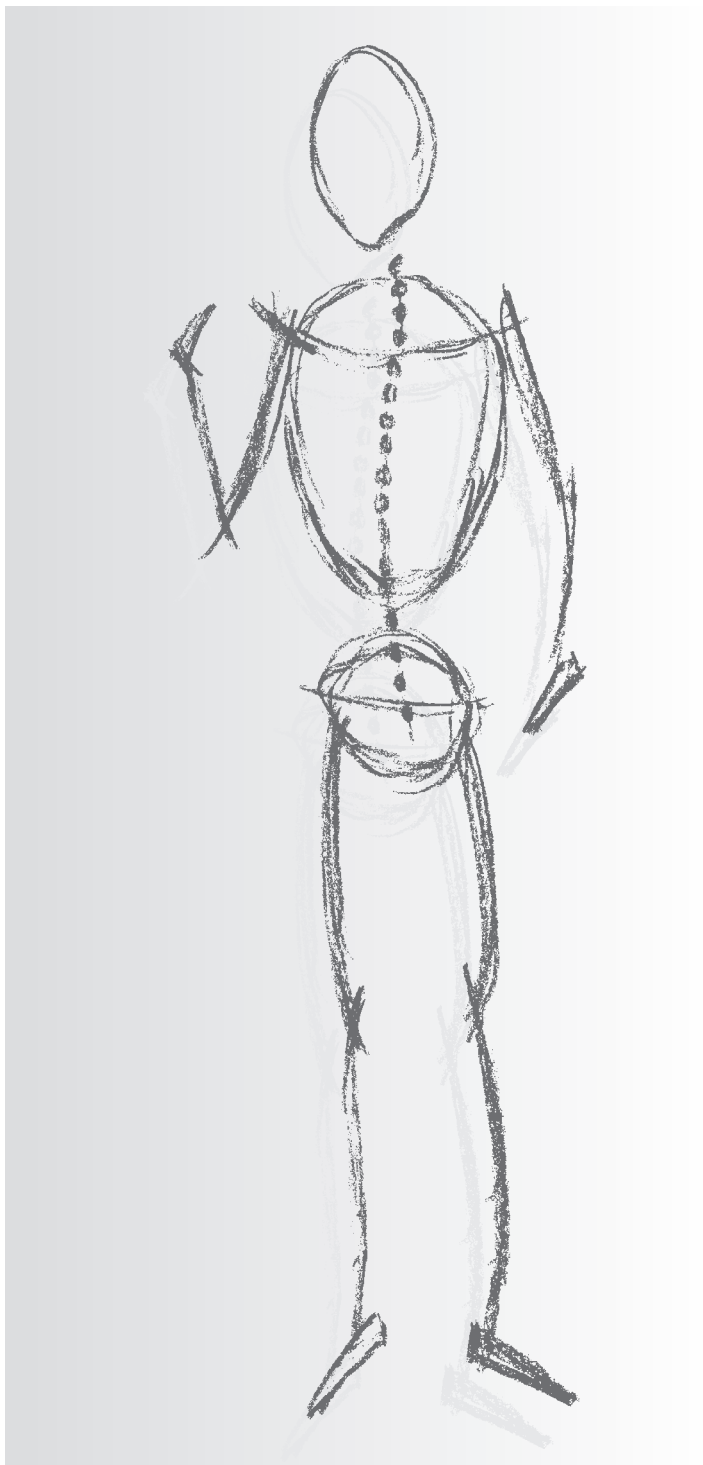

Reda Instrumente GmbH
Gänsäcker 34 - P.O. Box 131
D-78532 Tuttlingen

STIRNLAMPEN

HEAD LIGHTS

LÁMPARAS FRONTALES

Nystagmusbrille
Nystagmus Spectacles
Anteojos para nistagmo



FRENZEL

03167-03
Beleuchtete Nystagmusbrille
mit querliegendem Batterie-
handgriff und festen Gläsern

03167-03
Nystagmus Spectacles for
observation of the eyes during
examination of the vestibular
apparatus, with battery handle
and fixed glasses. Illuminated
on inside of lenses.

03167-03
Anteojos para nistagmo, con
iluminación, con mango para
pilas en forma horizontal,
vidrios fijos,

Energiequelle:
2 Stück 4-Volt-Lämpchen
2 Stück Baby-Zellen 1.5 V

Source of energy:
2 bulbs 4-volt
2 baby-battery cells 1.5 V

Alimentación:
2 unidades de bombillas de
4 voltios
2 unidades de pilas de
1.5 voltios



03165-07
Ersatzlampe
Spare bulb
Bombilla de repuesto

Stirnspiegel
Head Mirror
Espejos frontales



03180-93
ø 90 mm



ZIEGLER
03180-90
compl.



03180-92

03180-90
Ziegler-Stirnspiegel,
komplett, mit schwarzem
Stirnreifen,
mit Kugelgelenk,
90 mm ø

03180-90
Ziegler Head Mirror,
complete with black head
band, with ball socket,
90 mm ø

03180-90
Ziegler espejo frontal,
completo con cinta negra,
con articulación,
90 mm ø

03180-92
Stirnstreifen, allein

03180-92
head band, only

03180-92
cinta, suelta

03180-93
Spiegel, allein
90 mm ø

03180-93
Mirror, only
90 mm ø

03180-93
Espejo, suelto
90 mm ø

HNO Stirnleuchte
Miniature Headlight
Lampara frontal mini



03192-00
Fiberoptische Miniaturstirn-
leuchte für den OP-Bereich.
Miniatur-Hochleistungs-Optik,
Faserbündel- \varnothing 3,5 mm, heller /
homogener Lichtfleck, leder-
gepolstertes Stirnband mit
seitlichen Kopfstützen und
Stellrad. Lieferung ohne
Adapter für Lichtquelle.

03192-00
Fibre Optic miniature head-
light for operation theatre.
Perfect view by very small
optic. The fibre bundle diameter
of 3.5 mm and the double lens
system effects a small and
homogenous light spot with
lateral head supports. Easily
adjustable by hand wheel.
Supplied without adapter for
light source.

03192-00
Frontal de luz fría para pro-
funda e intensiva iluminación.
El cable de fibra optica de
3,5 mm de diametro y su
sistema de doble lente ofrece
una iluminacion clara y homo-
génea haz de luz con soportes
laterales. Facilmente ajustable
con el sistema de rueda.
Suministrado sin adaptador
para fuente de luz.



03192-01
wie 03192-00, aber Projektorseite 90°
same as 03192-00, but projector side 90° angled
como 03192-00, pero terminal para proyector angulado en 90°



03193-20
Adapter
Adapter
Adaptador

HNO Stirnleuchte, Kaltlicht
Headlight Microfocus, Fibre Optic
Lampara frontal mini, luz fria

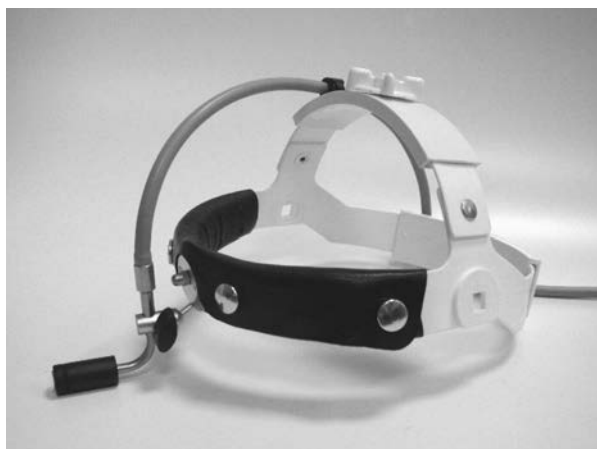

03193-00
Stirnlampe mit stufenlos
variablen Mikrofokus zur
blendfreien Tiefenausleuch-
tung. Durch kleinen Licht-
austritt und verstellbarer
Kleinoptik optimales Sichtfeld.
Komplett mit 2,2 m F/O-Kabel
(Faserbündel- \varnothing 3,5 mm) und
ledergepolstertem Kopfbügel-
Stirnreif. Ohne Adapter für
Lichtquelle.

03193-00
Headlight with stepless
variable micro focus for inten-
sive depth illumination. Very
small focus. 2.2 m F/O cable
(fibre bundle \varnothing 3.5 mm). Ergo-
nomic and leather padded
headband with crossband.
Supplied without adapter for
light source.

03193-00
Frontal de luz con focus
variable y progresion continua
con cable de 2,2 m largo y
3,5 mm de diámetro. Cabezal
recubierto de piel e ergonó-
mico. Se suministra sin
adaptador para fuente de luz.



03193-01
wie 03193-00, aber Projektorseite 90°
same as 03193-00, but projector side 90° angled
como 03193-00, pero terminal para proyector angulado en 90°



03193-20
Adapter
Adapter
Adaptador

Stirnlampe
Head Light
Lámpara frontal



CLAR
03195-00

komplett mit Stirnstreifen und Kabel
complete with head band and cable
completo con cinta frontal y cable



03195-01
ø 55 mm



03195-06
6 Volt

Spiegel aus Glas ohne Fassung
Glass Mirror without frame
Reflector de cristal, sin montura



03195-07 Kleintransformator
220 Volt = 0 - 10 Volt / 3 Watt
Mini-Transformer Unit
Transformador eléctrico pequeño

03195-08 Kleintransformator
110 Volt = 0 - 10 Volt / 3 Watt
Mini-Transformer Unit
Transformador eléctrico pequeño

Stirnlampe
Head Light
Lámpara frontal

03194-00
Xenon Stirnlampe mit Batteriebox
Xenon headlight with battery box
Lámpara frontal Xenon con caja para batería



03194-01
Ersatzlampe mit Reflektor
Spare lamp with reflector
Lámpara de repuesto con reflector

03196-00
Kabellose OP-LED-Stirnleuchte,
schwarz, mit Kopfbügel und Akku

Wireless OT-LED-Headlight,
black, with headband

Lámpara frontal LED, inalámbrica,
negra con cinta y batería



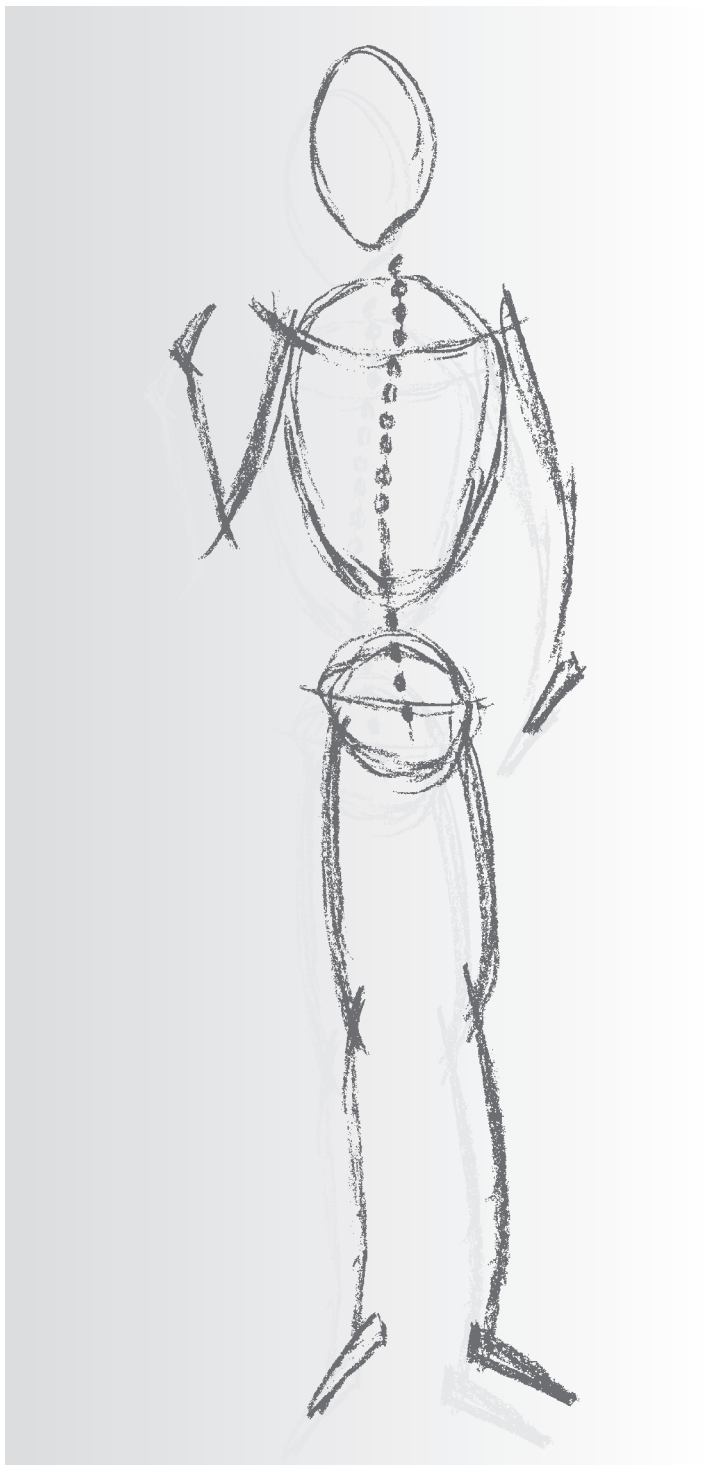

Reda Instrumente GmbH
Gänsäcker 34 - P.O. Box 131
D-78532 Tuttlingen

BOHRER

BURRS

BROCAS

Indikationen und Kontraindikationen finden Sie in der entsprechenden Gebrauchsanweisung!
Indication and Contraindication please refer to our user's manual!
Indicaciones y Contraindicaciones se encuentran en la instrucciones de uso correspondientes!

Bohrer 70 mm, Schaft 2,35 mm
 Burrs, 70 mm, Schaft 2.35 mm
 Brocas, 70 mm, vástago 2,35 mm

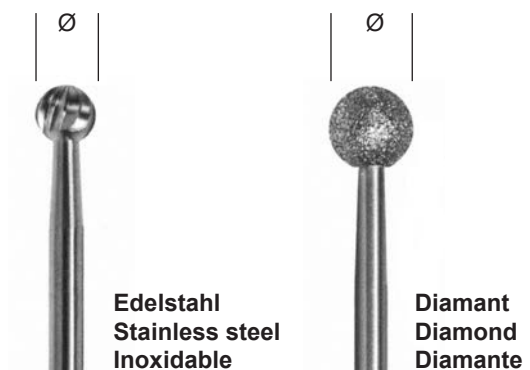

Ø 0,60 mm	50236-06	
Ø 0,70 mm		50242-07
Ø 0,80 mm	50236-08	50242-08
Ø 1,00 mm	50236-10	50242-10
Ø 1,40 mm	50236-14	
Ø 1,50 mm		50242-15
Ø 1,80 mm	50236-18	50242-18
Ø 2,00 mm		50242-20
Ø 2,30 mm	50236-23	50242-23
Ø 2,50 mm		50242-25
Ø 2,70 mm		50242-27
Ø 3,00 mm		50242-30
Ø 3,10 mm	50236-31	
Ø 3,50 mm	50236-35	50242-35
Ø 4,00 mm	50236-40	50242-40
Ø 4,50 mm	50236-45	50242-45
Ø 5,00 mm	50236-50	50242-50
Ø 6,00 mm	50236-60	50242-60
Ø 7,00 mm	50236-70	50242-70

Bohrer 70 mm, Schaft 2,35 mm
 Burrs, 70 mm, Shaft 2.35 mm
 Brocas, 70 mm, vástago 2,35 mm



**Hartmetall
 Tungsten Carbide
 Tungsteno**

**Hartmetall grob
 Tungsten Carbide coarse
 Tungsteno grueso**

Ø 0,60 mm	50237-06	
Ø 0,70 mm		
Ø 0,80 mm	50237-08	
Ø 1,00 mm	50237-10	
Ø 1,40 mm	50237-14	
Ø 1,50 mm		
Ø 1,80 mm	50237-18	
Ø 2,00 mm		
Ø 2,30 mm	50237-23	
Ø 2,50 mm	50237-25	
Ø 2,70 mm	50237-27	
Ø 3,00 mm	50237-30	
Ø 3,10 mm		
Ø 3,50 mm	50237-35	50238-35
Ø 4,00 mm	50237-40	50238-40
Ø 4,50 mm	50237-45	50238-45
Ø 5,00 mm	50237-50	50238-50
Ø 6,00 mm	50237-60	
Ø 7,00 mm	50237-70	

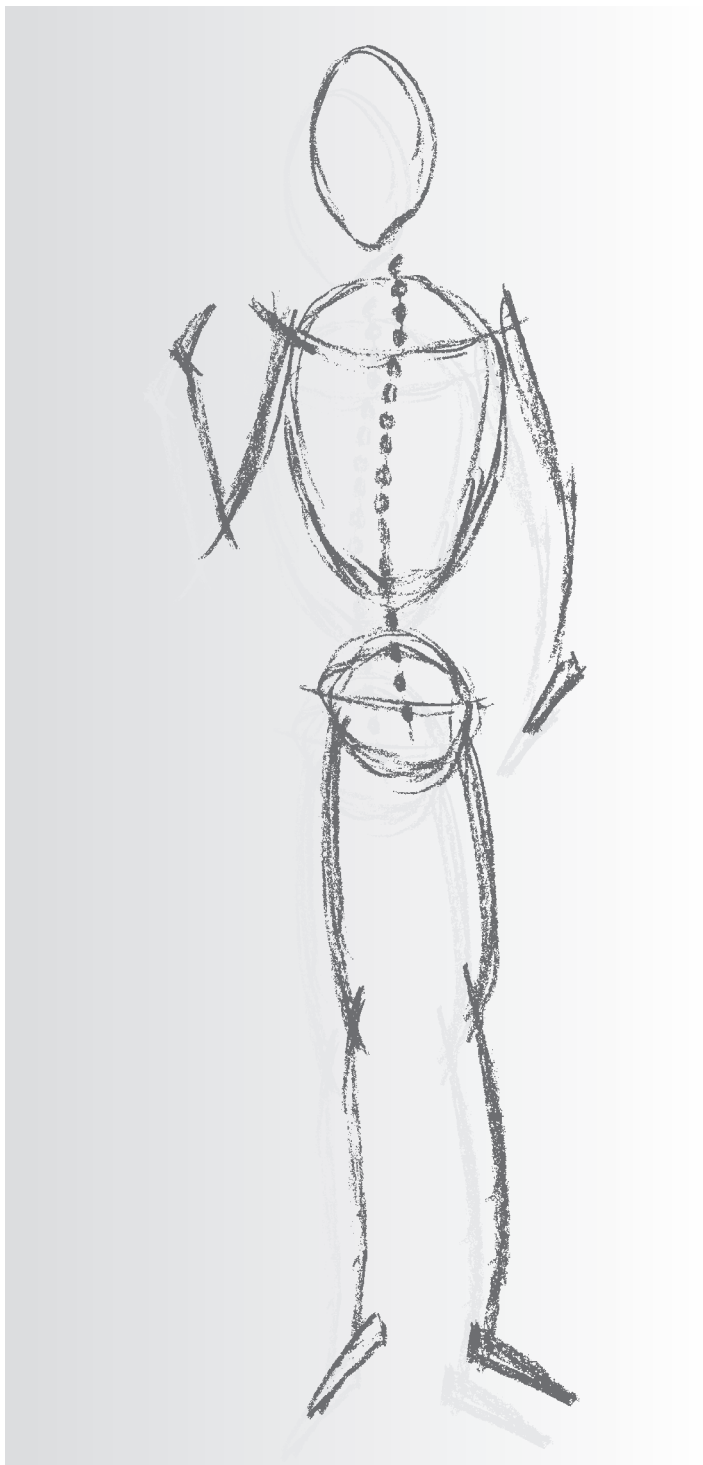

Reda Instrumente GmbH
Gänsäcker 34 - P.O. Box 131
D-78532 Tuttlingen

**HOCHFREQUENZ-
CHIRURGIE**

**HIGH FREQUENCY
SURGERY**

**CIRUGIA DE ALTA
FRECUENCIA**

Hochfrequenz-Chirurgie
High Frequency Surgery
Electrocirugía

Mindestbestellmenge 10
Minimum order quantity 10
Cantidad minima 10



91010-01
Fig. 1



91010-02
Fig. 2 45°



91010-03
Fig. 3 120°



91010-11
Fig. 11
Ø 3 mm



91010-12
Fig. 12
Ø 5 mm



91010-13
Fig. 13
Ø 8 mm



91010-14
Fig. 14



91010-15
Fig. 15 45°
7,0x1,5 mm



91010-16
Fig. 16 45°
7 mm



91010-17
Fig. 17
6,0x1,3 mm



91010-18
Fig. 18 30°
7,0x1,7 mm



91010-21
Fig. 21
7,0x1,7 mm



91010-31
Fig. 31 45°
Ø 0,6 mm



91010-33
Fig. 33 45°
Ø 1,7 mm



91010-34
Fig. 34 45°
Ø 3,0 mm



91010-35
Fig. 35



91010-36
Fig. 36 90°

Schaft
shaft
vástago
Ø 2,4 mm

Mindestbestellmenge 10
Minimum order quantity 10
Cantidad minima 10

Hochfrequenz-Chirurgie
High Frequency Surgery
Electrocirugía



91011-51
Fig. 51 45°
Ø 3 mm



91011-52
Fig. 52 45°
7,0x1,7 mm



91011-53
Fig. 53 45°



91011-54
Fig. 54



91011-55
Fig. 55



91011-56
Fig. 56 45°
Ø 5 mm



91011-61
Fig. 61 45°



91011-62
Fig. 62 90°

Schaft
shaft
vástago
Ø 2,4 mm

Serie STANDARD



91020-01



91020-02

Schaft
shaft
vástago
Ø 4 mm



91020-03



91020-04



Ø mm
5 91022-05
10 91022-10
20 91022-20



Ø mm
10 91024-10
15 91024-15
20 91024-20



Ø mm
2 91030-02
4 91030-04
6 91030-06

Schaft
shaft
vástago
Ø 4 mm

Bipolare Koagulation
Bipolar Coagulation
Coagulación bipolar



91102-11
11 cm, 4 3/8"



91104-11
11 cm, 4 3/8"



91109-11
11 cm, 4 3/8"
45°
0.5 mm



91113-11
11 cm, 4 3/8"
45°
0.5 mm



91115-11
11 cm, 4 3/8"
45°
0.5 mm



91122-16
16,5 cm, 6 1/2"
0.5 mm



91123-16
16,5 cm, 6 1/2"
0.5 mm



91124-16
16,5 cm, 6 1/2"
1 mm



91125-16
16,5 cm, 6 1/2"
0.5 mm



91127-16
16,5 cm, 6 1/2"
1 mm

Bipolare Koagulation
Bipolar Coagulation
Coagulación bipolar



91142-16
16,5 cm, 6 ½"
1 mm



91144-16
16,5 cm, 6 ½"
0.5 mm



91146-16
16,5 cm, 6 ½"
1 mm



91152-19
19,5 cm, 7 ¾"
0.3 mm



91154-19
19,5 cm, 7 ¾"
1 mm



91157-19
19,5 cm, 7 ¾"
1 mm



91159-19
19,5 cm, 7 ¾"
2 mm

Bipolare Koagulation
Bipolar Coagulation
Coagulación bipolar



91162-19
19,5 cm, 7 3/4"
0.3 mm



91164-19
19,5 cm, 7 3/4"
1 mm



91166-19
19,5 cm, 7 3/4"
2 mm



91167-19
19,5 cm, 7 3/4"
1 mm



91169-19
19,5 cm, 7 3/4"
1 mm



91172-03 - 91172-12
22,5 cm, 8.9"



91172-03
0,3 mm



91172-07
0,7 mm









91172-12
1,2 mm

Verbindungskabel, bipolar
 Connection Cords, bipolar
 Cables de conexión, bipolar

Unit side

Instrument side

	Cable length Meter	Flat plug europe	
			
Erbe / Storz 12,5 mm Ø 	3	R065-040125-003	R065-040125-103
	5	R065-040125-005	R065-040125-105
Martin / Berchtold 8 mm Ø AESCULAP Wolf 	3	R065-020080-003	R065-020080-103
	5	R065-020080-005	R065-020080-105
Valleylab / Lamidey / EMC 	3	R065-040285-003	R065-040285-103
	5	R065-040285-005	R065-040285-105
2-Pin U.S. Standard Eschmann 	3	R065-040000-003	R065-040000-103
	5	R065-040000-005	R065-040000-105

Bipolare Koagulation
Bipolar Coagulation
Coagulación bipolar

NON STICK

gerade
straight
recta



	0,3 mm	0,5 mm	1,0 mm	2,0 mm
11,0 cm, 4 3/8"	91110-03N	91110-05N	91110-10N	
16,0 cm, 6 1/4"	91160-03N	91160-05N	91160-10N	91160-20N
18,0 cm, 7"		91180-05N	91180-10N	91180-20N
19,5 cm, 7 3/4"		91200-05N	91200-10N	91200-20N
22,0 cm, 8 3/4"			91220-10N	91220-20N
24,0 cm, 9 1/2"			91240-10N	
30,0 cm, 12"			91300-10N	91300-20N

abgewinkelt 45°
angled 45°
angulada 45°



	0,3 mm	0,5 mm	1,0 mm	2,0 mm
11,0 cm, 4 3/8"	91112-03N	91112-05N	91112-10N	
16,0 cm, 6 1/4"		91162-05N	91162-10N	
18,0 cm, 7"			91182-10N	91182-20N
19,5 cm, 7 3/4"		91202-05N	91202-10N	91202-20N
22,0 cm, 8 3/4"			91222-10N	91222-20N
24,0 cm, 9 1/2"			91242-10N	

NON STICK

Bipolare Koagulation
Bipolar Coagulation
Coagulación bipolar

bayonett gerade
bayonet straight
bayoneta recta



	0,3 mm	0,5 mm	1,0 mm	2,0 mm
16,0 cm, 6 1/4"	91166-03N	91166-05N	91166-10N	91166-20N
19,5 cm, 7 3/4"		91206-05N	91206-10N	91206-20N
22,0 cm, 8 3/4"		91226-05N	91226-10N	91226-20N
24,0 cm, 9 1/2"		91246-05N	91246-10N	91246-20N

bayonett nach oben
bayonet upwards
bayoneta hacia arriba



	1,0 mm
19,5 cm, 7 3/4"	91207-10N
22,0 cm, 8 3/4"	91227-10N

bayonett nach unten
bayonet downwards
bayoneta hacia abajo



	0,5 mm	1,0 mm
16,0 cm, 6 1/4"	91168-05N	91168-10N
19,5 cm, 7 3/4"		91208-10N
22,0 cm, 8 3/4"		91228-10N

Bipolare Saugpinzetten
Bipolar Suction Forceps
Pinza de succión bipolar

Saugpinzetten zum Absaugen von Blut und Sekret vor der Koagulation bzw. zum Absaugen von Rauch während der Koagulation.

Europäischer Flachstecker zum Anschluß von bipolaren Kabeln für praktisch alle gebräuchlichen HF-Generatoren.

Der Saugkanal mit Unterbrecherloch ist in einem Schenkel der Pinzette integriert.

An der Schlaucholive können verschiedene Schlauchdurchmesser angeschlossen werden.

Suction forceps for extraction of blood and debris by suction right before coagulation or extraction of smoke while coagulating.

European flat socket connector for bipolar cables for nearly all common high frequency generators.

Suction channel integrated inside the forceps.

Suction connector matches different suction tube diameters.

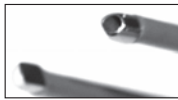

Pinza de succión para sangre y líquidos antes de efectuar la coagulación como también para la eliminación de humo durante la coagulación.

Enchufe plano europeo para conectar cables bipolares de equipos de alta frecuencia en uso corrientemente.

El canal de succión con su agujero de interrupción está incorporado en un lado de la pinza.

El diseño de la oliva de conexión permite la adaptación de tubos de varios diámetros.

Monopolar Saugkoagulator
Monopolar Suction Coagulator
Coagulador de succión monopolar antiadherente

NON STICK

gerade, biegsam
straight, malleable
recta, maleable



91179-18N
18 cm, 7"

Bipolare Stichkoagulationselektrode
Bipolar Stich Coagulation Electrodes
Electrodos de coagulación de puncion, bipolar



91176-19
19 cm, 7 1/2"
20°



91177-20
19,5 cm, 7 3/4"
55°



Bipolare Koagulationselektrode MICRODOME
Bipolar Coagulation Elektrode MICRODOME
Electrodo de coagulación bipolar MICRODOME

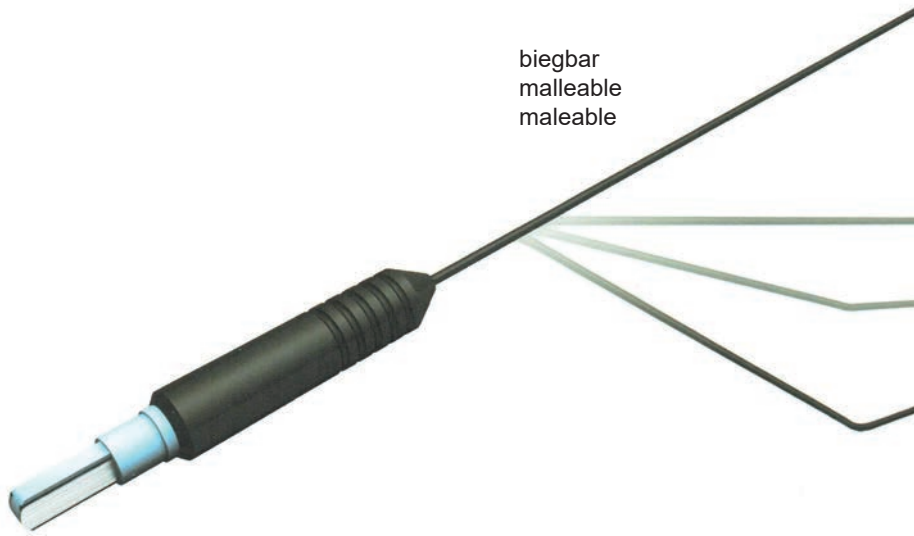

91178-14
14 cm, 5 1/2"

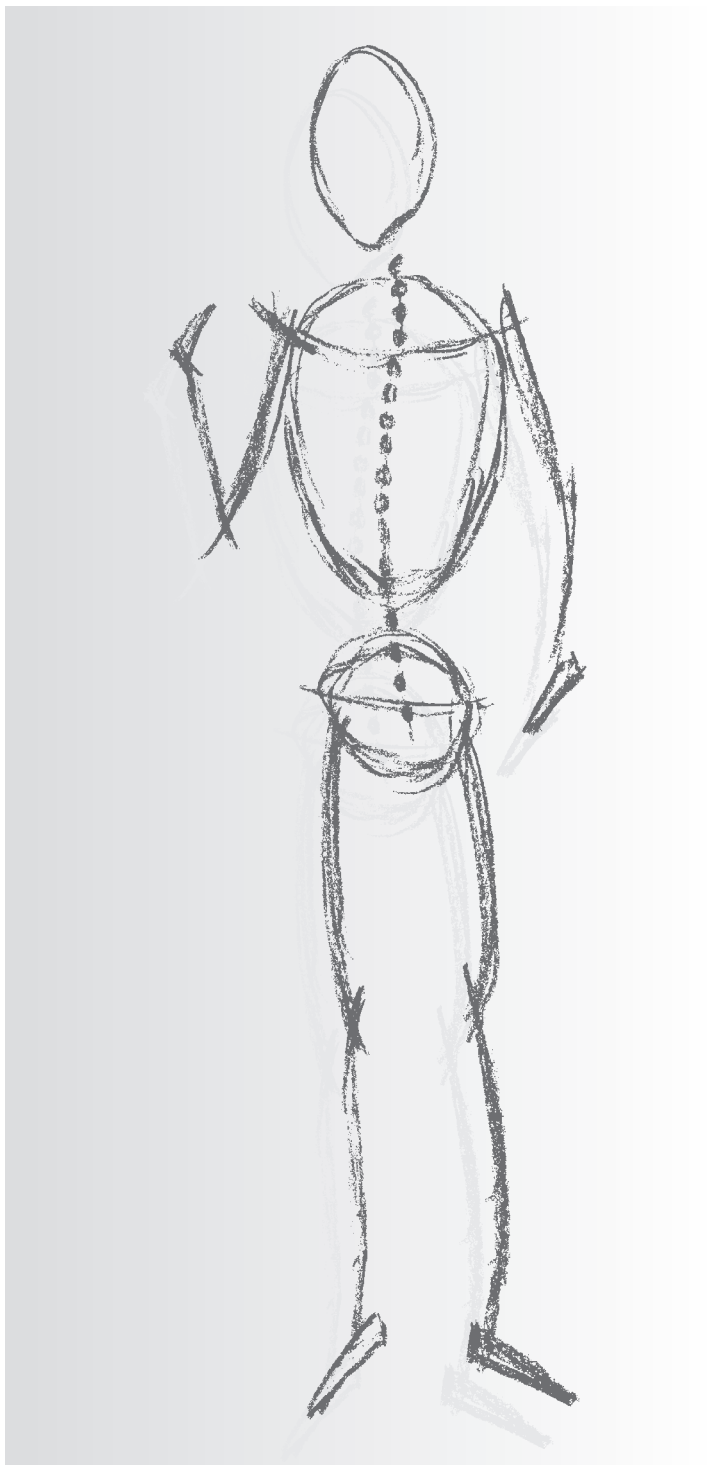

Reda Instrumente GmbH
Gänsäcker 34 - P.O. Box 131
D-78532 Tuttlingen

OTOLOGIE

OTOLOGY

OTOLOGÍA

Diagnostik-Bestecke mit Standardbeleuchtung
Diagnostic Sets with Standard Illumination
Estuches de diagnóstico con iluminación standard

UNI I



Nr. 03161-00

Weltbekanntes und preiswertes Otoskop mit Standardbeleuchtung 2,5 V. Besonders geeignet für Studenten und Ärzte.
Set bestehend: Aus **Otoskopkopf** verchromt, mit Steckverschluß. **Verchromter Batteriegriff 28 mm ø** für 2 Batterien Typ C. Mit abnehmbarem Abdeckglas in Kunststoff-Fassung mit Plastikconnector für den pneumatischen Test. Die verchromte Schwenklinse ist abnehmbar und vergrößert 4,0-fach. Die Lichtstärke kann anhand des Rheostates reguliert werden. Mit 3 wiederverwendbaren Ohrtrichtern 2, 3 und 4 mm ø. Komplett in silberfarbener Kunststofftasche.

No. 03161-00

World famous otoscope set at a budget price for physicians and students. 2,5 V standard illumination for use with 2 batteries type C.

Set includes: **Otoscope head** with pin contact fitting. Chrome-plated. Fixed protective lens in plastic mount may be removed for introduction of instruments. Plastic connector for pneumatic otoscopy. Removable swivel-mounted 4 x magnifier. 2, 3 and 4 mm reusable specula included. **Battery handle 28 mm ø** for 2 C-cell batteries. Chrome-plated. With thumb wheel for securing pin contact heads. With rheostat for adjustment of illumination. Complete in silver-colored plastic pouch.

No. 03161-00

Otoscopio muy popular y económico con iluminación standard 2,5 V apropiado para estudiantes y médicos, de fama mundial.

Cabeza otoscopio cromada, con cierre de tornillo. **Mango a pilas cromado 28 mm ø** para dos pilas tipo C. Con cristal de cubierto desmontable en armadura plástica. Con conector plástico para el test neumático. La lente giratoria es desmontable y amplifica 4,0 veces mas. La intensidad de la luz es regulable con el reostato. Con tres especulos reutilizables 2, 3 y 4 mm ø. Completo en bolsa de plástico de color gris plata.

Diagnostik-Bestecke mit Standardbeleuchtung
Diagnostic Sets with Standard Illumination
Estuches de diagnóstico con iluminación standard

UNI II



Nr. 03161-01

Weltbekanntes und preisgünstiges **May-Ophthalmoskop**: mit Standardbeleuchtung 2,5 V. Besonders für Studenten und Ärzte geeignet. Ophthalmoskop mit Steckverschluß. Anhand des Linsenrades können Korrekturlinsen von 0 bis +20 und 0 bis -20 Dioptrien gewählt werden. Mit einer Blende: großer Kreis. Mit verchromtem **Batteriegriff**: 28 mm ø für 2 Batterien Typ C. Die Lichtstärke kann anhand des Rheostates reguliert werden. Komplett in silbergrauer Kunststofftasche.

No. 03161-01

World-famous ophthalmoscope set at a budget price for physicians and students. 2,5 V standard illumination for use with 2 batteries Type C. Set includes: **May ophthalmoscope head**: Pin contact fitting. Lens selection wheel permits choice of corrective lenses from 0 to +20 and 0 to -20 diopters. Single large circle aperture. **Battery handle**: 28 mm ø for 2 C-cell batteries. Chrome-plated. With thumb wheel for securing pin-contact heads. Rheostat for adjustment of illumination. Complete in silver-gray plastic pouch.

No. 03161-01

Oftalmoscopio May: muy popular y económico con iluminación standard 2,5 V, apropiado para estudiantes y médicos de fama mundial. Oftalmoscopio con cierre de tornillo. Con ayuda de la rueda de lentes se puede elegir lentes de corrección de 0 a +20 y o a -20 dioptrías. Y con una apertura: gran círculo. Con **mango a pilas**: cromado 28 mm ø para dos pilas tipo C. La intensidad de la luz es regulable con el reostato. Completo en bolsa de plástico de color gris plata.

Diagnostik-Bestecke mit Standardbeleuchtung
Diagnostic Sets with Standard Illumination
Estuches de diagnóstico con iluminación standard

UNI III



Nr. 03161-02

Weltbekanntes diagnostisches Besteck mit Standardbeleuchtung 2,5 V. Äußerst beliebt und sehr preiswert. Besonders geeignet für Studenten und Ärzte. Das Set besteht aus folgenden Teilen: **Otoskopkopf** verchromt, mit Steckverschluss. Abnehmbares Abdeckglas in Kunststofffassung, mit Plastikconnector für pneumatischen Test. Abnehmbarer Schwenklinse (Vergrößerung 4,0-fach). 3 wiederverwendbaren Ohrtrichtern 2, 3 und 4 mm ø. **May-Ophthalmoskop** mit Steckverschluss. Anhand des Linsenrades können Korrekturlinsen von 0 bis +20 und 0 bis -20 Dioptrien gewählt werden. Mit einer Blende: großer Kreis. **Batteriegriff** verchromt, 28 mm ø für 2 Batterien Typ C. Die Lichtstärke kann anhand des Rheostates am Batteriegriff reguliert werden. Alle Teile komplett in silbergrauer Kunststofftasche.

No. 03161-02

World-famous otoscope/ophthalmoscope diagnostic set at a budget price for physicians and students. 2,5 V Standard illumination for use with 2 batteries type C. Set includes: **Otoscope head** - Pin contact fitting. Chrome-plated. Fixed protective lens in plastic mount may be removed for introduction of instruments. Plastic connector for pneumatic otoscopy. Removable swivel-mounted 4 x magnifier. 2, 3 and 4 mm reusable specula included. **May ophthalmoscope head**. Pin contact fitting. Lens selection wheel permits choice of corrective lenses from 0 to +20 and 0 to -20 diopters. Single large circle aperture. **Battery handle**. 28 mm ø for 2 C-cell batteries. Chrome-plated. With thumb wheel for securing pin-contact heads. Rheostat for adjustment of illumination.

No. 03161-02

Este estuche de diagnóstico con iluminación standard 2,5 V es muy popular y muy económico, apropiado para estudiantes y médicos. Juego, compuesto de: **Cabeza otoscopio** cromado, con cierre de tornillo. Con cristal de cubierto en armadura plástica, con conector plástico para el test neumático. Con lente giratorio desmontable (amplificación: 4 veces más). **Cabeza oftalmoscopio May** con cierre de tornillo. Con ayuda de la rueda de lentes se puede elegir lentes de corrección de 0 a +20 y 0 a -20 dioptrías. Con una apertura: gran círculo. **Mango a pilas** cromado, 28 mm ø para dos pilas tipo C. La intensidad de la luz es regulable con el reostato al tope del mango. Todos los partes se presentan en una bolsa plástica de color gris plata.

Diagnostik-Bestecke mit Standardbeleuchtung
Diagnostic Sets with Standard Illumination
Estuches de diagnóstico con iluminación standard



ECO "T" 03161-03T

- a) Otoskop, mit Schraubverschluss und 3 Ohrtrichtern, 2-3-4 mm
Otoscope with screw fitting and 3 ear speculas with, 2-3-4 mm
Otoscopio, con cierre a tornillo y con 3 espéculos auriculares de 2-3-4 mms
- b) Ophthalmoskop, 0 bis +20 und 0 bis -20 Dioptrien, mit Schraubverschluss
Ophthalmoscope from 0 to +20 and 0 to -20 dioptres with screw fitting
Oftalmoscopio, 0 a + 20 y 0 a - 20 dioptrías, con cierre a tornillo
- c) Nasenspekulum
Nasal Speculum
Espéculo nasal
- d) Lampenträger mit Schraubverschluss
Bent arm illuminator with screw fitting
Porta-lámpara, con cierre a tornillo
- e) 2 Kehlkopfspiegel No. 3 und 4
2 laryngeal mirrors no. 3 and 4
Espejos laringeos Nos. 3 y 4
- f) Mundspatelhalter
Tongue blade holder
Abaja-lenguas
- g) Batteriegriff für 2 Batterien mit Schraubverschluss (ohne Batterien)
Battery handle for 2 batteries
Mango para 2 pilas, con cierre a tornillo (sin pilas)
- h) Ersatzlämpchen 2.5 V
Spare lamp 2.5 V
Bombillo de repuesto 2.5 V

ECO "C" 03161-03C

Inhalt gleich wie oben, mit drehbarem Schnellverschluss.
Contents same as above, but with quick plug-in connector.
Mismo contenido como arriba pero con CIERRE RAPIDO GIRATORIO.

Diagnostik-Bestecke mit Xenonbeleuchtung
Diagnostic Sets with Xenon Illumination
Estuches de diagnóstico con iluminación Xenon



Kleine, sehr moderne Qualitätsinstrumente aus Kunststoff, grau, mit Xenonbeleuchtung XL 2,5 V. Sehr preiswert und aufgrund der Größe besonders gut für die Arzttasche geeignet. Schraubverschluss. **Otoskop:** Fiber-Optik. Anschluß für pneumatischen Test. Lupe vergrößert 2,5-fach. Batteriegriff für 2 Batterien Typ AA. **Ophthalmoskop:** Korrekturlinsen: 0 bis +20 und 0 bis -20 Dioptrien. Blenden: Kreis groß + klein, Halbkreis, Fixierstern und Grünfilter. Griff für 2 Batterien Typ AA. Das Otoskop- und das Otoskop/Ophthalmoskop-Besteck werden jeweils mit einem Metallkonnektor für pneumatischen Test und Plastikröhrchen mit jeweils 5 wiederverwendbaren Ohrtrichtern 2,5 und 4,0 mm geliefert. Komplet in modernem schwarzen Kunststoffetui.

- Nr. 03171-00 - Otoskop mit Griff AA.**
- Nr. 03171-01 - Ophthalmoskop mit Griff AA.**
- Nr. 03171-02 - Otoskop/Ophthalmoskop jeweils mit Griff AA.**

Economically priced state-of-the-art quality instrument made of plastics, gray color, with Xenon illumination XL 2,5 V. Due to its small size it is most suitable for each practitioner's bag. **Otoscope:** Fiber optic. Screw type fitting. 2,5 x magnifying glass. Battery handle for 2 AA-cell batteries. **Ophthalmoscope:** Corrective lenses ranging from 0 to +20 and 0 to -20 diopters. Apertures: large and small circle, semi-circle, fixation star and green filter. Otoscope and otoscope/ophthalmoscope set each contain a metal connector for pneumatic otoscopy as well as plastic tube with 5 each reusable ear specula 2,5 and 4,0 mm. All sets come in modern black plastic case.

- No. 03171-00 - Otoscope with AA-handle.**
- No. 03171-01 - Ophthalmoscope with AA-handle.**
- No. 03171-02 - Otoscope/ophthalmoscope with 1 each AA-handle.**

Instrumentos de calidad, muy moderno y pequeño de plástico resistente, gris, con iluminación Xenon XL 2,5 V. Muy económico y gracias al tamaño apropiado para el bolsillo del médico. Cierre roscado. **Otoscopio:** fibra óptica. Conexión para test neumático. Lupa aumenta 2,5 veces más. Mango a pilas para 2 pilas, tipo AA. **Oftalmoscopio:** Lentes de corrección: 0 hasta +20 y 0 hasta -20 dioptrías. Aberturas: círculo grande y pequeño, semicírculo, estrella fijadora y filtro verde. Con mango para 2 pilas, tipo AA. Juego de otoscopio y de otoscopio/oftalmoscopio con conector metálico para el test neumático y con 5 espéculos reutilizables de 2,5 y 4,0 mm en tubo de plástico. Todos los juegos se presentan en estuche de plástico negro moderno.

- No. 03171-00 - Otoscopio con mango AA.**
- No. 03171-01 - Oftalmoscopio con mango AA.**
- No. 03171-02 - Oto/oftalmoscopio con mangos AA.**

Ohrspekula
Ear Specula
Especulos auriculares



POLITZER
45009-00
Set = 3

- Innen Ø
- = 2,0 mm
45009-02
 - = 3,0 mm
45009-03
 - = 4,0 mm
45009-04



HARTMANN
45010-00
Set = 4,5 - 7,5 mm

- Innen Ø
- = 2,0 mm
45010-20
 - = 3,0 mm
45010-30
 - = 4,5 mm
45010-45
 - = 5,5 mm
45010-55
 - = 6,5 mm
45010-65
 - = 7,5 mm
45010-75



HARTMANN
45011-00
Set 3-7 mm

- schwarz
black
negro
- Innen Ø
- = 2,0 mm
45011-03
 - = 3,5 mm
45011-04
 - = 5,0 mm
45011-05
 - = 6,5 mm
45011-07
 - = 7,5 mm
45011-08



TOYNBEE
45012-00
Set = 5,5 - 7,5 mm

- Innen Ø
- = 4,0 mm
45012-40
 - = 5,5 mm
45012-55
 - = 6,5 mm
45012-65
 - = 7,5 mm
45012-75



GRUBER, rund
45014-00
Set = 4

- Innen Ø
- = 4,5 mm
45014-45
 - = 5,5 mm
45014-55
 - = 6,5 mm
45014-65
 - = 7,5 mm
45014-75

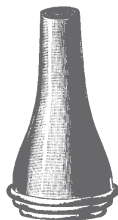

GRUBER, oval
45015-00
Set = 3

- Innen Ø
- = 4,5 mm
45015-45
 - = 5,5 mm
45015-55
 - = 6,5 mm
45015-65



BOUCHERON
45018-00
Set = 4

- Innen Ø
- = 5,0 mm
45018-50
 - = 6,0 mm
45018-60
 - = 7,0 mm
45018-70
 - = 8,0 mm
45018-80

Ohrspekula
Ear Specula
Espéculos auriculares

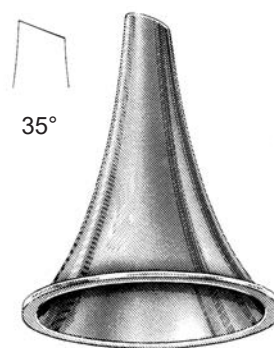
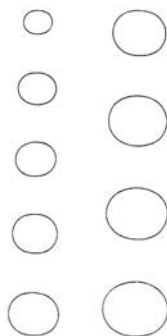
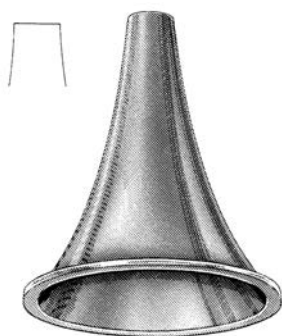

FARRIOR

45019-30	3,0 x 4,0 mm
45019-40	4,0 x 5,0 mm
45019-45	4,5 x 5,5 mm
45019-50	5,0 x 6,0 mm
45019-55	5,5 x 6,5 mm
45019-60	6,0 x 7,0 mm
45019-65	6,5 x 7,5 mm
45019-70	7,0 x 8,0 mm
45019-75	7,5 x 8,5 mm

FARRIOR

45020-30	3,0 x 4,0 mm
45020-40	4,0 x 5,0 mm
45020-45	4,5 x 5,5 mm
45020-50	5,0 x 6,0 mm
45020-55	5,5 x 6,5 mm
45020-60	6,0 x 7,0 mm
45020-65	6,5 x 7,5 mm
45020-70	7,0 x 8,0 mm
45020-75	7,5 x 8,5 mm

Ohrspekula
Ear Specula
Especulos auriculares

6,5 mm



45030-06

7,5 mm



45030-07

8,2 mm



45030-08

10 mm



45030-10

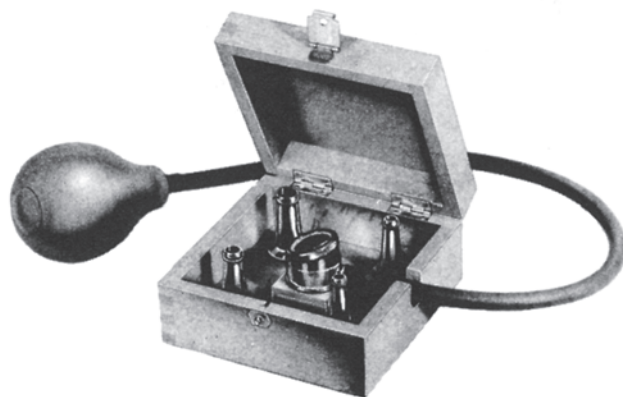

BRUENINGS
45030-04

45030-04

Komplett bestehend aus:
4 Spekula, Saugkammer mit
Gebläse, Holzetui

Complete consisting of:
4 specula, suction head and rubber
tube with bulb, wooden case

Compuesto de:
4 espéculos, cámara de aspiración,
insuflador de goma, en estuche de
madera

Ersatzteile / spare parts / repuestos

45036-09

Lupe / Magnification glass / lupa

45036-10

Saugpumpe / rubber ball / pera de
goma

Ohrspekula
Ear Specula
Espéculos auriculares



7,5 mm Ø



45036-06



8,5 mm Ø



45036-07



9,5 mm Ø



45036-08

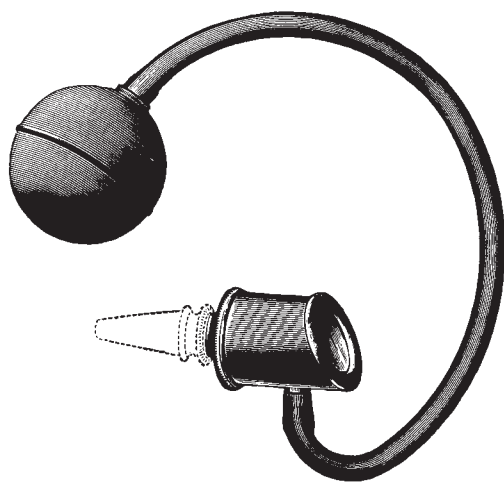

SIEGLE
45036-03

45036-03
Komplett bestehend aus:
Ohrspekulum, 3 Spekula, 1 Gebläse

Complete consisting of:
Ear Specula, 1 rubber tube with bulb

Completo, compuesto de:
Otoscopio con 3 espéculos, insuflador y tubo

Ohrspekulahalter
Ear Specula Holder
Soporte para espejos auriculares

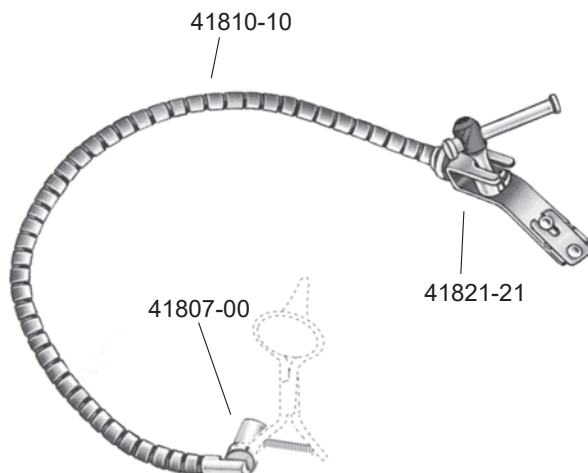

YASARGIL

41803-01 Ohrspekulahalter, komplett, bestehend aus:
ear specula holder, complete, consisting of:
soporte para espejos auriculares completo, compuesto de:

41810-10 flexibler Spannarm
flexible arm, only
brazo flexible, suelto

41821-21 Fixiervorrichtung zum Befestigen an Rohrteilen bis Ø 16 mm
clamp for fixation on bars up to Ø 16 mm
dispositivo de fijacion para tubos hasta Ø 16 mm



41807-00
Ohrspekulahalter alleine
Ear specula holder only
Soporte para espejos auriculares, suelto

Stimmgabeln
Tuning Forks
Diapasones

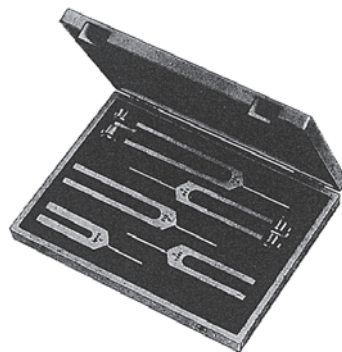
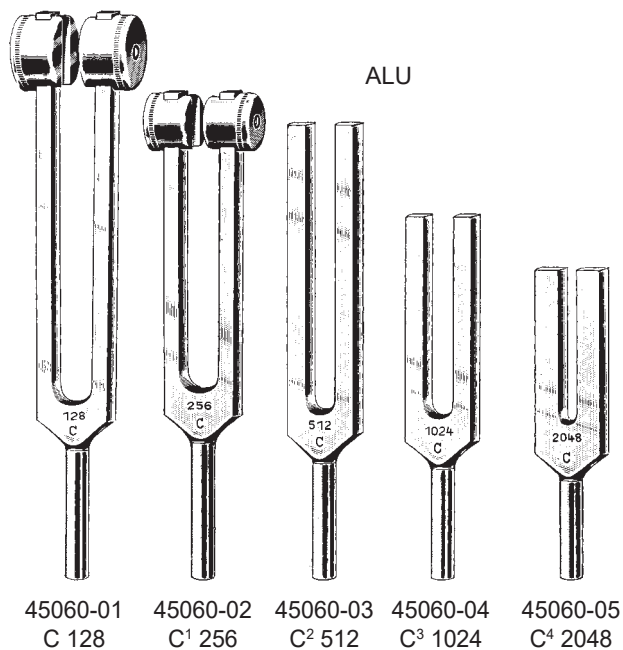

45061-00
compl.

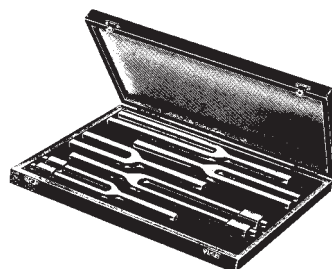
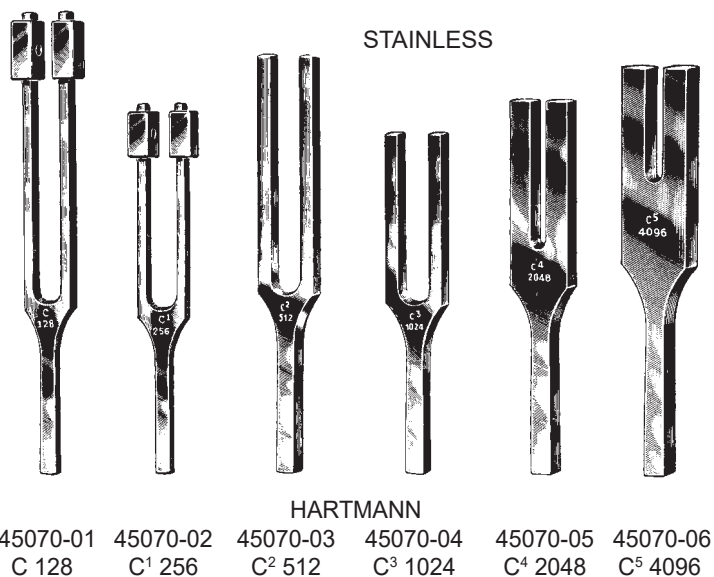

HARTMANN
45071-00
compl.

Stimmgabeln
Tuning Forks
Diapasones



45072-01
a¹ 440



LUCAE
45073-01 C 128
45073-02 C¹ 256
45073-03 C² 512
45073-04 C³ 1024
45073-05 C⁴ 2048
45073-06 C⁵ 4096



LUCAE
45074-01
C 128

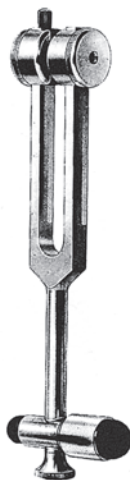

45075-00

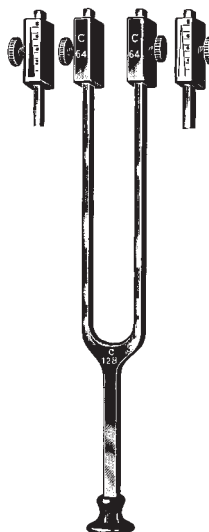

RYDEL-SEIFFERT
45076-01 C 128 / C 64

Lärmtrommel, Pulverbläser
 Noise Apparatus, Powder Blowers
 Ensordecedor, Lanzapolvo



BARANY
 45080-00

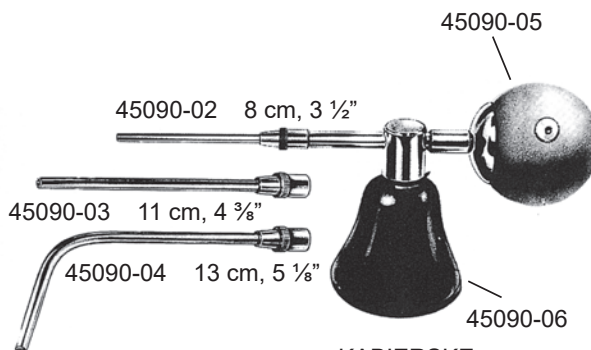

KABIERSKE
 45090-00 30 ccm
 komplett mit 3 Kanülen und Gummiball
 complete with 3 cannulas and rubber bulb
 completo con 3 cánulas y pera de goma

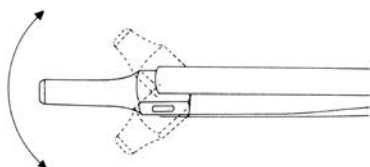

UNIVERSAL
 45090-08

komplett mit beweglicher Düse,
 Schraubflasche 30 ccm und Halbgebläse

complete with movable tube, screw bottle
 30 ccm and rubber bulb

completo con tubo móvil, botella con rosca de
 30 ccm y pera de goma

Luftdusche, Ohrspritze
Air Bag, Ear Syringe
Insuflador de aire, Jeringa auricular



45091-02
Gummibirne alleine
Rubber bulb only
Pera de goma, sola



45091-03



45091-04
4 mm Ø



45091-15
15 mm Ø



45091-17
17 mm Ø



45091-22
22 mm Ø

POLITZER
45091-00 Set
incl.
45091-03
45091-15
45091-17
45091-22

POLITZER
45091-01 Set
incl.
45091-03
45091-04
45091-15
45091-17
45091-22

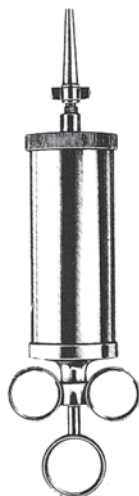

ml REINER, compl.
50 45096-50
75 45096-75
100 45097-10
150 45097-15

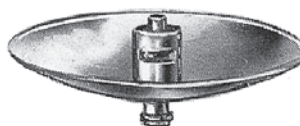

45097-01



45097-02



45097-03

Ohrspritze
Ear Syringe
Jeringa auricular

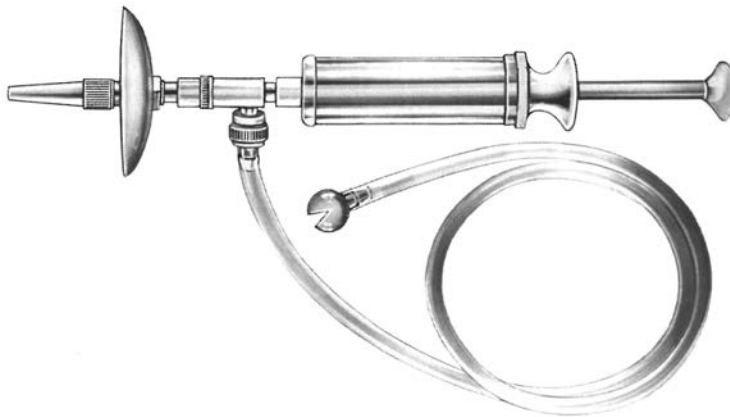

45096-00

Ohrspritze komplett, 10 ml selbstfüllend mit Luer-Lock Ansatz
Ear syringe, 10 ml one hand filling and emptying, Luer-Lock attachment
Jeringa auricular, 10 ml, con conexion Luer-Lock

Ohrsonden, Watteträger
 Ear Probe, Cotton Applicators
 Sondas auriculares, Porta-algodones

ø 1 mm
 Silber



STACKE
 21115-10
 10,5 cm 4.1"

ø 1,2 mm



spiralförmig
 spiral threads
 estrías espirales

FARRELL

4 3/4" 21270-12 12,0 cm
 5 1/2" 21270-14 14,0 cm
 6 1/2" 21270-16 16,5 cm

ø 1,2 mm



FARRELL

21272-12 12,0 cm
 21272-14 14,0 cm
 21272-16 16,5 cm

ø 1 mm

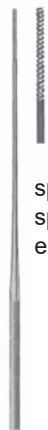

spiralförmig
 spiral threads
 estrías espirales

FROHN

4 3/4" 21277-12 12,0 cm
 5 1/2" 21277-14 14,0 cm
 6 1/4" 21277-16 16,0 cm

Watteträger
Cotton Applicators
Porta-algodones



spiralförmig
spiral threads
estrías espirales

REDA

21290-12 12,0 cm, 4 3/4"
21290-14 14,0 cm, 5 1/2"
21290-16 16,0 cm, 6 1/4"



REDA

21292-12 12,0 cm, 4 3/4"
21292-14 14,0 cm, 5 1/2"
21292-16 16,0 cm, 6 1/4"

ø 1,3 mm



UCKERMANN
21310-15 15 cm, 6"

ø 3 mm



JOBSON-HORNE
21320-12 12 cm, 4 3/4"
21320-18 18 cm, 7"

Löffel, Schlingen, Hebel
 Ear Spoons, Loops, Elevator
 Cucharas, Asas, Elevador



GROSS
 45171-12
 12 cm, 4 3/4"



GROSS
 45173-12
 12 cm, 4 3/4"



45180-01



45180-02



45180-03

BILLEAU
 16 cm, 6 1/4"



LANGENBECK
 45181-13
 13 cm, 5 1/8"



ZAUFAL
 45184-16
 16 cm, 6 1/4"

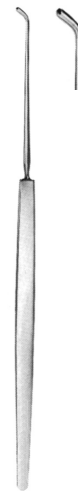

ZAUFAL-JANSEN
 45185-15
 15 cm, 6"

Häkchen
Ear Hooks
Ganchitos

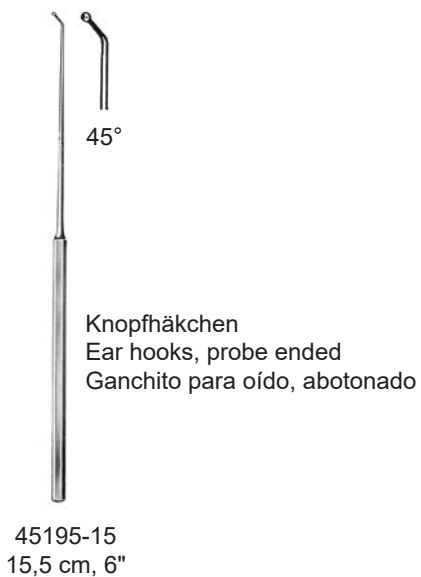
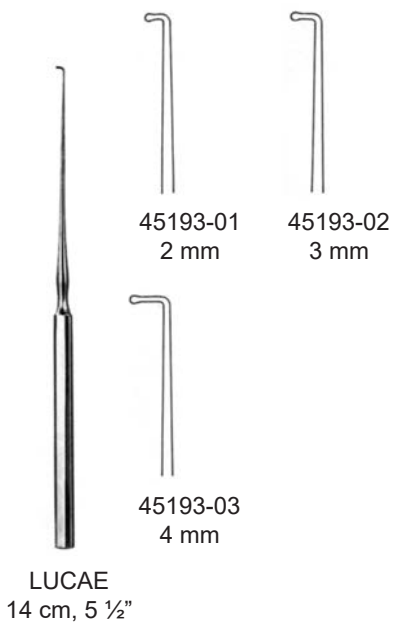
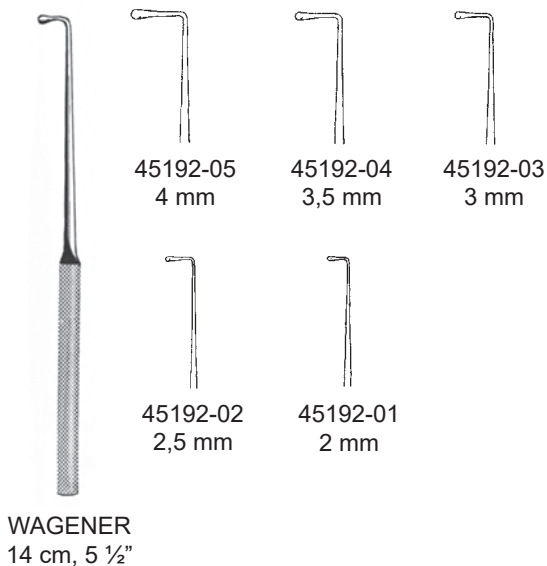
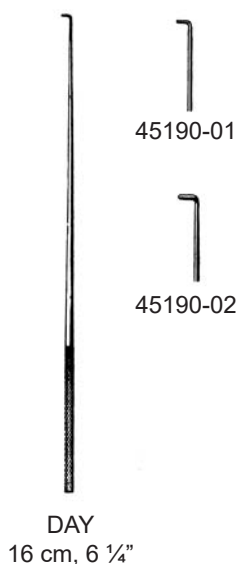

Ohrschlingen
Ear Loops
Lazos auriculares



45194-01



45194-02



45194-03



45194-04

SHAPLEIGH
13 cm, 5 1/8"



45195-00











45195-01



45195-02







WEBER-LOCH
16 cm, 6 1/4"

Ohrküretten
Ear Currettes
Curetas auriculares

	Innen Ø Inner Ø interior Ø	1.5 mm	1.9 mm	2.5 mm	2.7 mm
Küretten Currettes Curetas					
		Fig. 00	0	1	2
stumpf blunt romas		45109-00	45110-00	45110-01	45110-02
scharf sharp cortantes		45111-00	45112-00	45112-01	45112-02
stumpf blunt romas		45114-00	45115-00	45115-01	45115-02
scharf sharp cortantes		45116-00	45117-00	45117-01	45117-02

BUCK
14,5 cm, 5 3/4"

Ohrküretten
Ear Currettes
Curetas auriculares

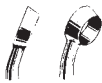
	Innen Ø Inner Ø interior Ø	3.4 mm	4.0 mm	4.5 mm
Küretten Currettes Curetas				
		3	4	5
stumpf blunt romas		45110-03	45110-04	45110-05
scharf sharp cortantes		45112-03	45112-04	45112-05
stumpf blunt romas		45115-03	45115-04	45115-05
scharf sharp cortantes		45117-03	45117-04	45117-05

BUCK
14,5 cm, 5 3/4"

Ohrkatheter, Trommelfellnadel
 Catheters, Tympanum Knives
 Cateteres, agujas para timpano

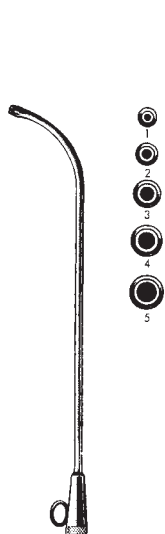
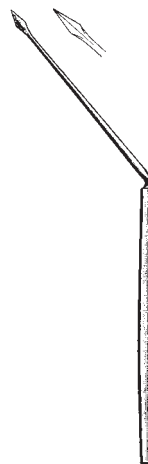

Fig. HARTMANN
 1 45133-01 2,5 mm
 2 45133-02 3,0 mm
 3 45133-03 3,5 mm
 4 45133-04 4,0 mm
 5 45133-05 5,0 mm



POLITZER
 45150-18
 18 cm, 7"



POLITZER
 45151-16
 16,5 cm, 6 1/2"



für Kinder
 for children
 para niños

LUCAE
 45152-01
 18 cm, 7"



für Erwachsene
 for adults
 para adultos

LUCAE
 45152-02
 18 cm, 7"

Trommelfellnadel
Tympanum Knives
Cuchillos para timpano

mit Schraubgriff
with screw-locking handle
con mango roscado

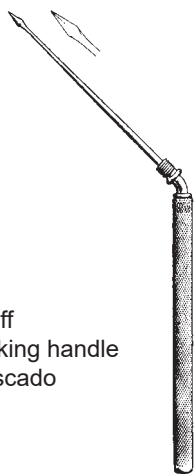

POLITZER
45153-16
16 cm, 6 1/4"



POLITZER
45160-15
15 cm, 6"



SEXTON
45162-18
18 cm, 7"



SEXTON
45164-17
17 cm, 6 3/4"



SEXTON
45165-17
17 cm, 6 3/4"

Ohrpolypenschnürer
Ear Polypus Snares
Polipotomos auriculares

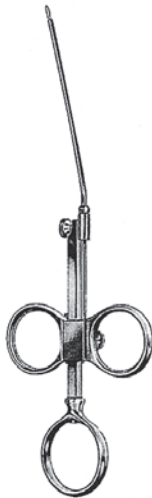

KRAUSE
45220-16
16 cm, 6 ¼"

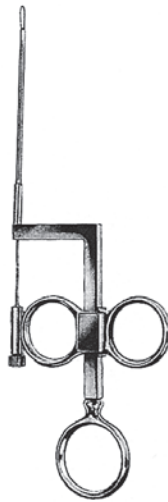

WILDE
45222-17
17 cm, 6 ¾"



45225-02
doz./doc./dozz.
0,2 mm

Fremdkörperheber
Foreign Body Levers
Elevadores para cuerpos extraños



QUIRE
45251-10
10 cm, 4"

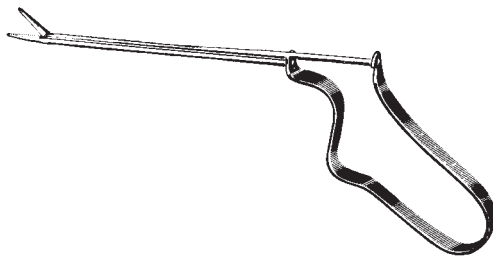

BUCK
45253-11
11 cm, 4 3/8"

Ohrzängchen
Ear Forceps
Pinzas auriculares

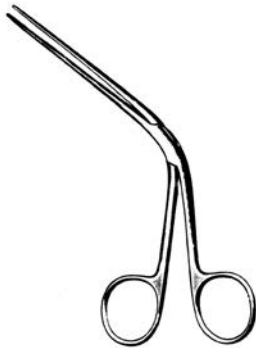

TILLEY
45243-14
14 cm, 5 1/2"



LITTAUER
45245-12
12 cm, 4 3/4"

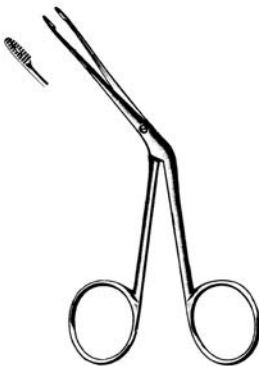

HARTMANN
45246-12
12 cm, 4 3/4"

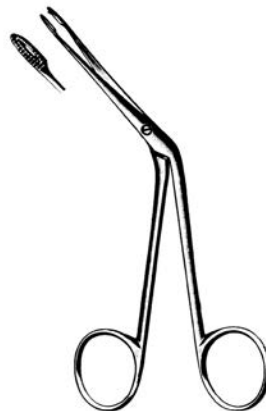

HARTMANN
45246-14
14 cm, 5 1/2"

Mikro Ohrzängchen
Micro Ear Forceps
Micro pinzas auriculares

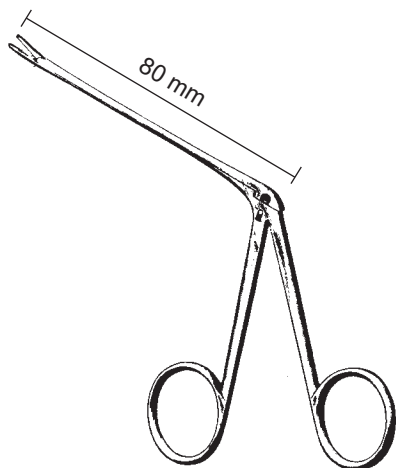

HARTMANN-WULLSTEIN
45255-08
8,5 cm, 3.4"

o 1 mm Ø



HARTMANN-WULLSTEIN
45257-08
8,5 cm, 3.4"



HARTMANN
45261-08 8,5 cm, 3.4"
45261-14 14,0 cm, 5 1/2"
45261-16 16,0 cm, 6 1/4"



HARTMANN
45263-08 8,5 cm, 3.4"
45263-14 14,0 cm, 5 1/2"



HARTMANN
45265-08
8,5 cm, 3.4"



Ø mm **HARTMANN**
2,0 45267-20 8,5 cm, 3.4"
2,5 45267-25 8,5 cm, 3.4"
3,0 45267-30 8,5 cm, 3.4"

3 mm Ø



HARTMANN
45269-30
8,5 cm, 3.4"



STRUEMPEL
45271-08 8,5 cm, 3.4"
2,5x5 mm



HARTMANN
45273-08
8,5 cm, 3.4"

o 2 mm Ø



HARTMANN-WEINGÄRTNER
45274-08
8,5 cm, 3.4"



HARTMANN-HOFFMANN
45275-08
8,5 cm, 3.4"



45276-08 Entenschnabel
14 cm, 5 1/2" Duckbill
Pico de pato

Mikro Ohrzängchen
 Micro Ear Forceps
 Micro pinzas auriculares

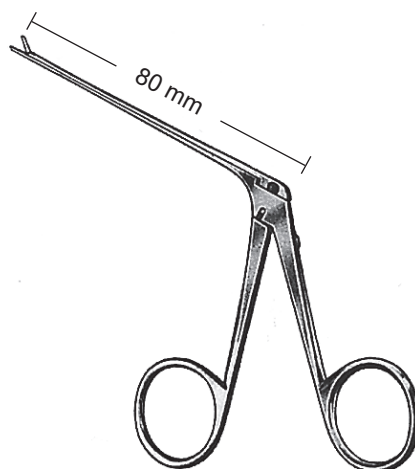

A
 45350-40
 0,9 x 4 mm



A
 45350-70
 0,9 x 7 mm

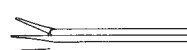

A
 45352-40
 0,9 x 4 mm



C
 45353-60
 0,9 x 6 mm



B
 45355-60
 0,9 x 6 mm



D
 45357-40
 0,9 x 4 mm



E
 45359-40
 0,9 x 4 mm



A
 45360-35
 0,6 x 3 mm

extra zart
 very delicate
 muy fina

- A: gerade / straight / recta**
- B: rechts / right / derecha**
- C: links / left / izquierda**
- D: aufgebogen / curved up / curva hacia arriba**
- E: nach unten gebogen / curved down / curva hacia abajo**

Mikro Ohrzangchen
Micro Ear Forceps
Micro pinzas auriculares

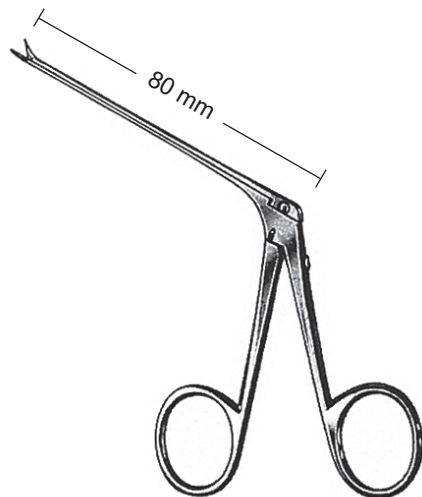

A

45361-01
0,6 x 4,5 mm

45362-45
0,9 x 4,5 mm



C

45361-02
0,6 x 4,5 mm

45363-45
0,9 x 4,5 mm



B

45361-03
0,6 x 4,5 mm

45365-45
0,9 x 4,5 mm



D

45361-04
0,6 x 5,0 mm

45367-50
0,9 x 5,0 mm

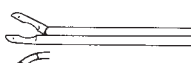

E

45361-05
0,6 x 5,0 mm

45369-50
0,9 x 5,0 mm

A: gerade / straight / recta

B: rechts / right / derecha

C: links / left / izquierda

D: aufgebogen / curved up / curva hacia arriba

E: nach unten gebogen / curved down / curva hacia abajo

Mikro Ohrzängchen
 Micro Ear Forceps
 Micro pinzas auriculares

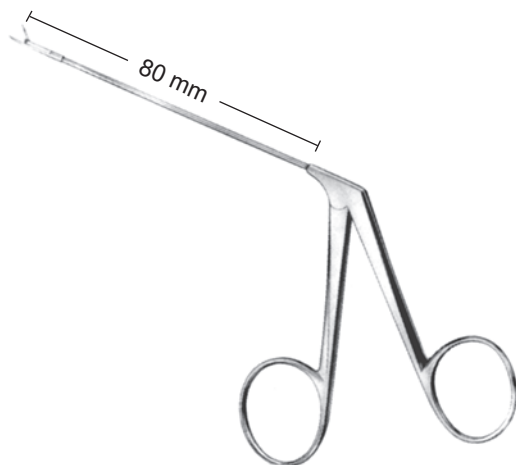

A
 45390-35
 0,8 x 3,5 mm



A
 45390-50
 1 x 5 mm



F
 45391-35
 0,8 x 3,5 mm



E
 45392-35
 0,8 x 3,5 mm



C
 45393-50
 1 x 5 mm

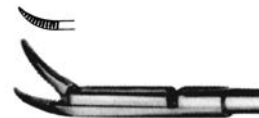

B
 45394-50
 1 x 5 mm

- A: gerade / straight / recta**
- B: rechts / right / derecha**
- C: links / left / izquierda**
- E: nach unten gebogen / curved down / curva hacia abajo**
- F: nach oben gebogen / curved upwards / curva hacia arriba**

Mikro Ohrzangchen
Micro Ear Forceps
Micro pinzas auriculares



WULLSTEIN



A
45400-01
0,9 x 1 mm



A
45400-02
0,8 x 1,3 mm



A
45400-03
1 mm



A
45401-25
1,7 x 2,5 mm



D
45402-10
0,9 x 1 mm



C
45403-13
0,8 x 1,3 mm



B
45404-13
0,8 x 1,3 mm

A: gerade / straight / recta
B: rechts / right / derecha
C: links / left / izquierda
D: aufgebogen / curved up / curva hacia arriba

Mikro Ohrscheren
 Micro Ear Scissors
 Micro tijeras auriculares

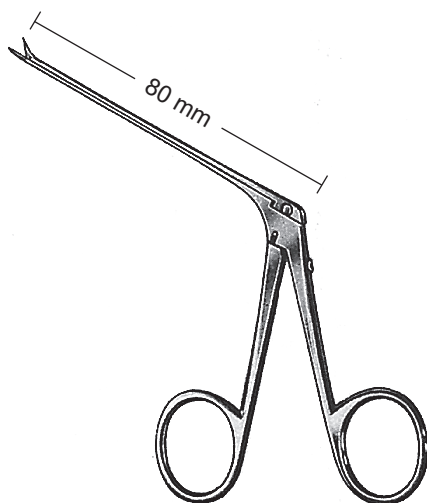

A
 BELLUCCI
 45300-30
 3 mm
 extra zart
 very delicate
 muy fina



A
 BELLUCCI
 45310-40
 micro mini
 4 mm



A
 BELLUCCI
 45312-55
 micro standard
 5,5 mm



D
 BELLUCCI
 45313-55
 micro standard
 5,5 mm

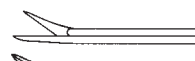

B
 BELLUCCI
 45315-55
 micro standard
 5,5 mm



C
 BELLUCCI
 45317-55
 micro standard
 5,5 mm



A
 SHEA
 45320-70
 7,0 mm



C
 SHEA
 45321-70
 7,0 mm



B
 SHEA
 45322-70
 7,0 mm

- A: gerade / straight / recta**
- B: rechts / right / derecha**
- C: links / left / izquierda**
- D: aufgebogen / curved up / curva hacia arriba**
- E: nach unten gebogen / curved down / curva hacia abajo**

Drahtbiegezängchen, Faßzängchen
Wire Bending Forceps, Grasping Forceps
Pinzas plegadoreas del alambre, Pinza prensora

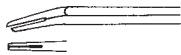

McGEE
45371-40
0,8 x 4,0 mm

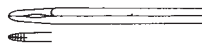

GREVEN
45370-50
0,8 x 5,0 mm



SCHUKNECHT
45372-60
0,8 x 6,0 mm

Mikro Ohrscheren
Micro Ear Scissors
Micro tijeras auriculares



FISCH

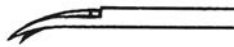

B
FISCH
45324-03
3,0 mm



C
FISCH
45325-03
3,0 mm

B: rechts / right / derecha
C: links / left / izquierda

Mikro Ohrscheren
Micro Ear Scissors
Micro tijeras auriculares

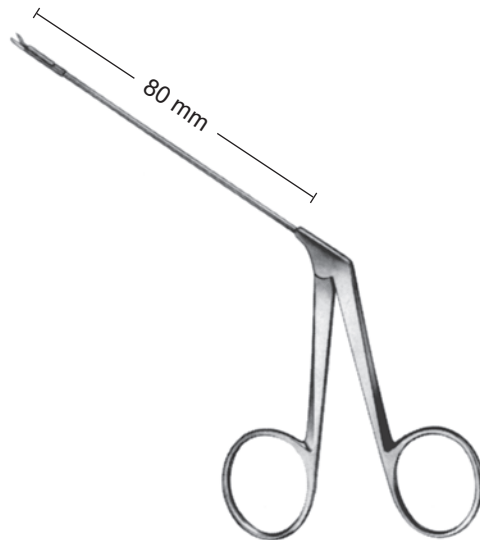

WULLSTEIN



A
45410-01



F
45411-01



C
45412-01



B
45413-01



G
45414-01

- A: gerade / straight / recta**
- B: rechts / right / derecha**
- C: links / left / izquierda**
- F: nach oben gebogen / curved upwards / curva hacia arriba**
- G: horizontal schneidend / horizontal cutting / corte horizontal**

Hammerkopfstanze
Malleus Punch
Pinza para cabeza del martillo

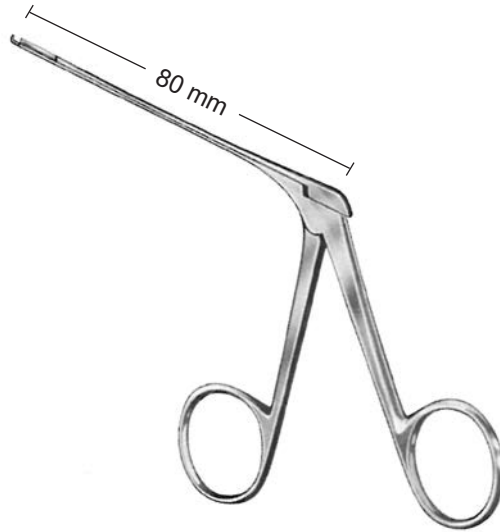

DIETER

micro ø 1,3 mm



45385-01

aufwärts
upward
arriba

mini ø 1,8 mm

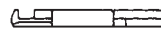

45387-01

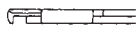

45385-02

abwärts
downward
abajo

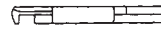

45387-02

Biegegerät, Quetschzange
Bending Device, Pressure Forceps
Dispositivo para modelar, Pinza para aplastar



SCHUKNECHT
45430-00

16 x 12 mm



HOUSE-GELFOAM
45440-19
19 cm, 7 ½"

Elevatoren, Raspatorien
Elevators, Raspatories
Elevadores, Periostótomos

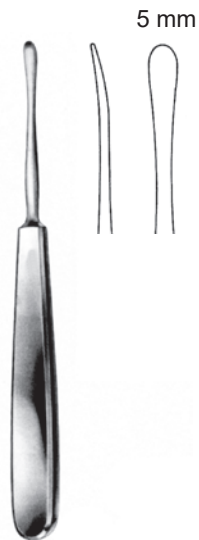

SEBILEAU
33707-17
17,5 cm, 7"



QUERVAIN
33708-19
19,5 cm, 7 3/4"



LANGENBECK
33710-19
19 cm, 7 1/2"

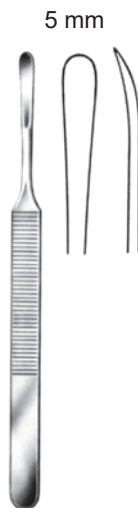

KÖNIG
33714-15
15,5 cm, 6"

Raspatorien
Raspatories
Periostótomos

4 mm



WILLIGER
33711-16
16 cm, 6 1/4"

6,5 mm



WILLIGER
33712-16
16 cm, 6 1/4"

5 mm



WILLIGER
33713-16
16 cm, 6 1/4"

5,5 mm



WILLIGER
33713-17
17 cm, 6 3/4"

Raspatorien, Elevatoren
Raspatories, Elevators
Periostótomos, Elevadores

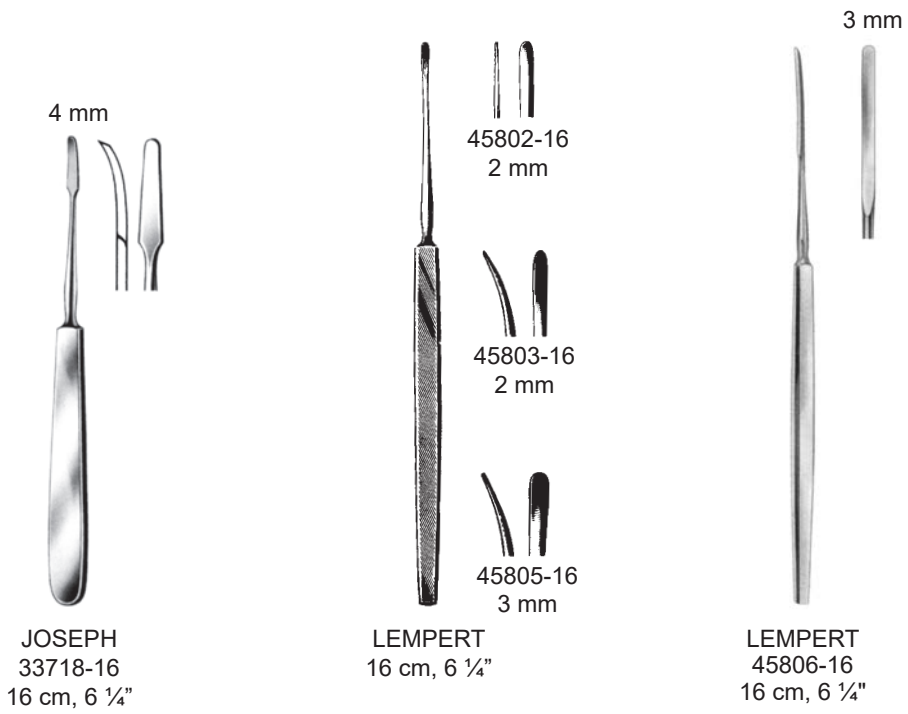

Raspatorien
Raspatories
Periostómos

mit Ferrozellgriff
with Ferrozell-Handle
con mango de Ferrozell

6 mm



33740-19
19 cm, 7 1/2"

3 mm



33741-18
18,5 cm, 7 1/4"

6 mm



33742-18
18,5 cm, 7 1/4"

6 mm



33743-18
18,5 cm, 7 1/4"

Raspatorien
Raspatories
Periostótomos

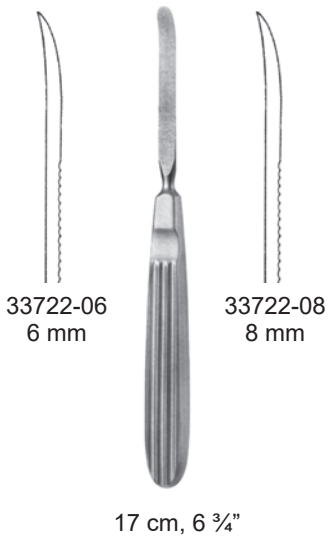

Raspatorien, Elevatoren
Raspatories, Elevators
Periostótomos, Elevadores

6 mm



LEMPERT
45807-20
20,5 cm, 8"

15 mm

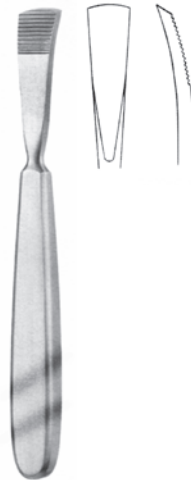

JANSEN
33701-16
16,5 cm, 6 1/2"

4,5 mm

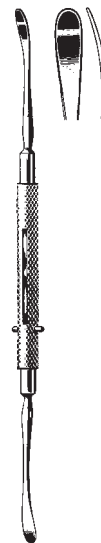

FREER
47415-18
18 cm, 7"

Elevatoren, Raspatorien
Elevators, Raspatories
Elevadores, Periostótomos

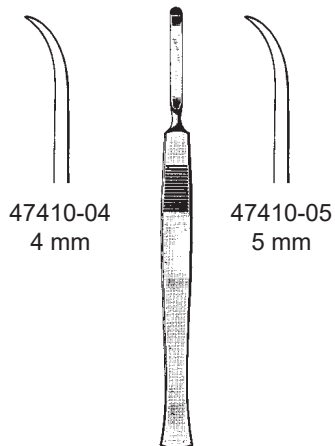

47410-04
4 mm

47410-05
5 mm

McKENTY
15 cm, 6"



MOLT
33716-18
18 cm, 7"



33724-02
2 mm

33724-03
3 mm

33724-04
4 mm

MILLER
17 cm, 6 3/4"



2,2 mm

WULLSTEIN
45806-17
17 cm, 6 3/4"

Dissektor, Raspatorien
Excavator, Raspatories
Disector, Periostótomos

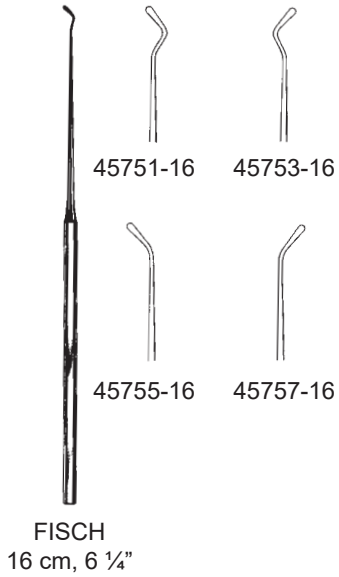

15 x 1,5 mm



15 x 1,0 mm

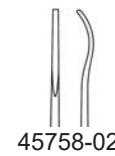

15 x 1,2 mm



ROSEN
15 cm, 6"

Ohrpinzetten
Ear Forceps
Pinzas auriculares

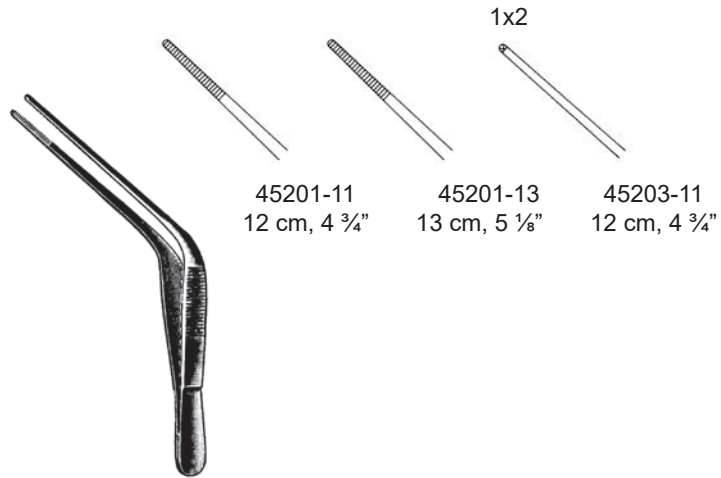

WILDE (TROELTSCH)

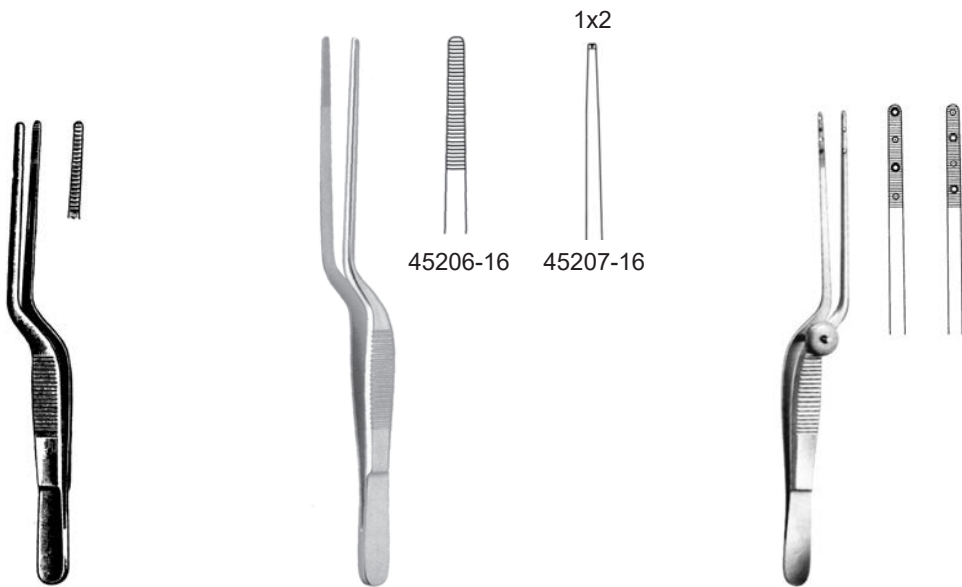

LUCAE
45206-14
14 cm, 5 1/2"

LUCAE
45207-16
16 cm, 6 1/4"

COTTLE
45208-14
14 cm, 5 1/2"

Anatomische und chirurgische Pinzetten
Dressing and Tissue Forceps
Pinzas de disección, sin/con dientes



STANDARD
11120-11
11,5 cm 4 ½"



GRAEFE
11190-10
10,5 cm, 4.1"



SEMKEN
11260-12 12,5 cm, 5"
11260-15 15,5 cm, 6"



SEMKEN
11270-12 12,5 cm, 5"
11270-15 15,5 cm, 6"

Uhrmacherpinzetten
Jeweler Type Forceps
Pinzas de relojero

Fig. 1



11401-01
12 cm, 4 $\frac{3}{4}$ "

Fig. 3



11403-03
12 cm, 4 $\frac{3}{4}$ "

Fig. 3c



11403-04
11 cm, 4 $\frac{3}{8}$ "

Fig. 4



11404-04
11 cm, 4 $\frac{3}{8}$ "

Fig. 5



11405-05
11 cm, 4 $\frac{3}{8}$ "

Fig. 7



11407-07
12 cm, 4 $\frac{3}{4}$ "

Ohrpinzetten
Ear Forceps
Pinzas auriculares



ADSON
11170-12 12,0 cm, 4 $\frac{3}{4}$ "
11170-15 15,0 cm, 6"



ADSON
11180-12 12,0 cm, 4 $\frac{3}{4}$ "
11180-15 15,0 cm, 6"

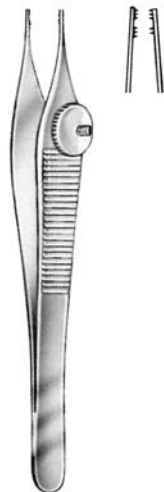

DERLACKI
45209-12
12 cm, 4 $\frac{3}{4}$ "

Flachmeißel, Hohlmeißel, Stößel
 Chisels, Gouges, Tampers
 Cinceles, Gubias, Hemostático

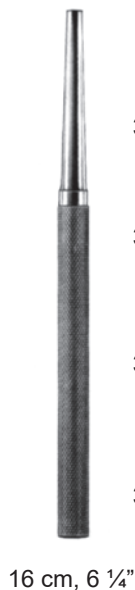

-  33600-02
2 mm
-  33600-03
3 mm
-  33600-04
4 mm
-  33600-05
5 mm

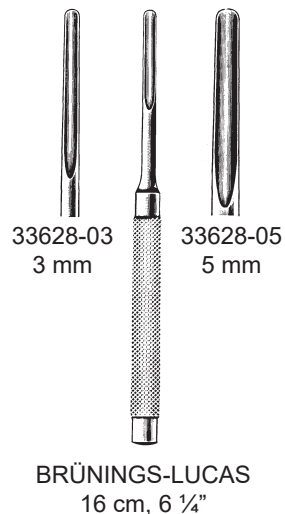
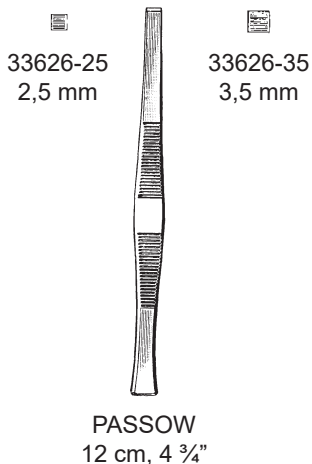
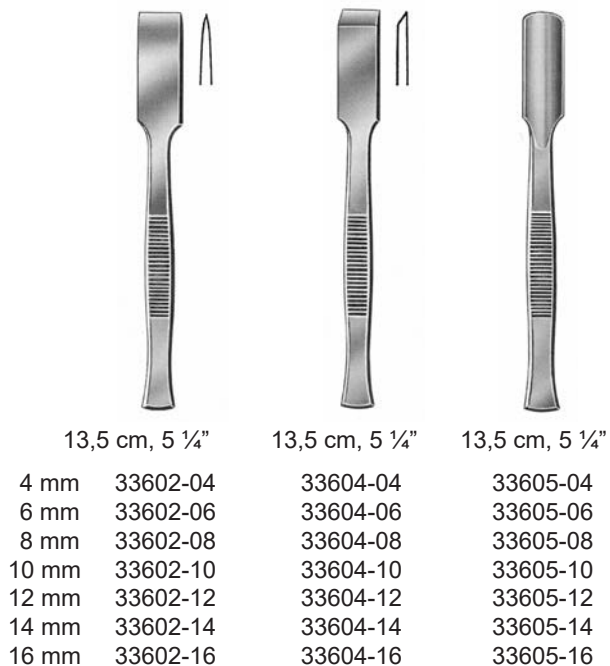

Flachmeißel, Hohlmeißel, Osteotome
 Chisels, Gouges, Osteotome
 Cinceles, Gubias, Osteótomo



PARTSCH

13,5 cm, 5 ¼"

- 33620-02 2 mm
- 33620-03 3 mm
- 33620-04 4 mm
- 33620-05 5 mm
- 33620-06 6 mm



PARTSCH

13,5 cm, 5 ¼"

- 33623-02 2 mm
- 33623-03 3 mm
- 33623-04 4 mm
- 33623-05 5 mm
- 33623-06 6 mm



2 mm



3 mm



4 mm



6 mm



8 mm



10 mm



12 mm



15 mm

- | | | |
|-------------|----|-------------|
| 12,5 cm, 5" | mm | 17 cm, 6 ¾" |
| 33654-02 | 2 | 33652-02 |
| 33654-03 | 3 | 33652-03 |
| 33654-04 | 4 | 33652-04 |
| 33654-06 | 6 | 33652-06 |
| 33654-08 | 8 | 33652-08 |
| 33654-10 | 10 | 33652-10 |
| 33654-12 | 12 | 33652-12 |
| 33654-15 | 15 | 33652-15 |

MINI-LAMBOTTE

Flachmeißel und Hohlmeißel mit Ferrozellgriff, Osteotome
 Chisels and Gouges with Ferrozell-Handle, Osteotome
 Cinceles, Gubias con mango de Ferrozell, Osteótomo

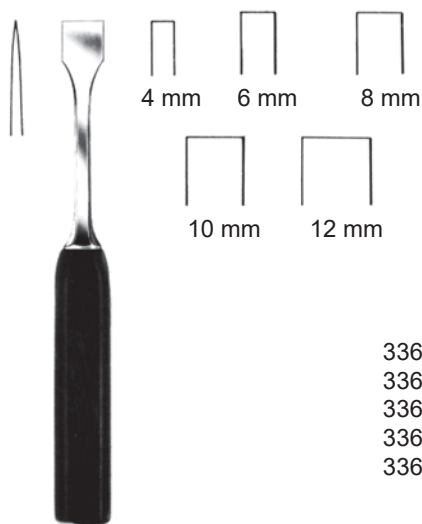

LEXER MINI
18 cm, 7"

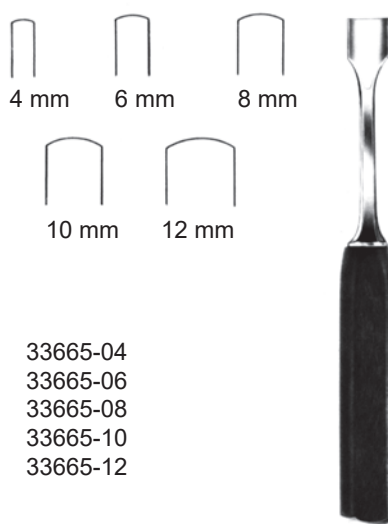

LEXER MINI
18 cm, 7"

33664-04	4 mm	33665-04
33664-06	6 mm	33665-06
33664-08	8 mm	33665-08
33664-10	10 mm	33665-10
33664-12	12 mm	33665-12



FREER
47450-04
15 cm, 6"



FREER
47451-04
15 cm, 6"

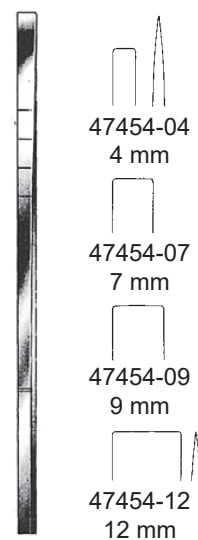

COTTLE
18 cm, 7"

Septum Osteotom
Rhinoplastic Osteotome
Osteotomo para rinoplastia



SHEEHAN
16 cm, 6 1/4"

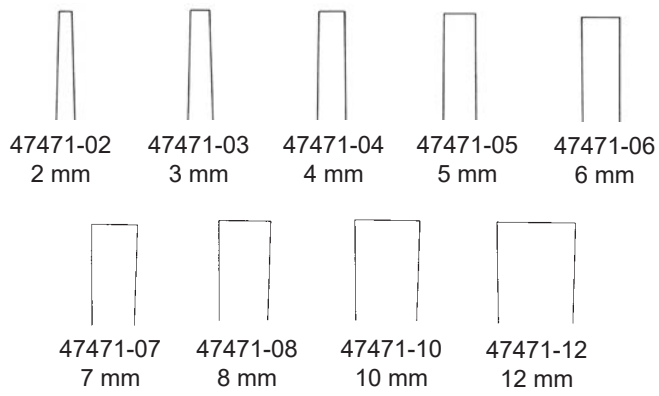

Hämmer
Mallets
Martillos

massiv, mit auswechselbaren Ferrozellbacken
solid, with interchangeable Ferrozell jaws
macizo, con tapas intercambiables de Ferrozell

Ø 20 mm



MEAD
17 cm, 6 ¾"
33693-32 320 g

Ø 25 mm



135 g

33694-01 18,5 cm, 7 ¼"
33694-03 Ersatzbacken
Nylon Caps
Tapas de repuesto

Ø 22 mm

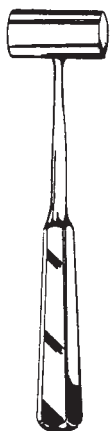

PARTSCH
33698-98
18 cm, 7"
199 g

Ø 30 mm



COTTLE
18 cm, 7" 240 g
33700-05

Ø 27 mm



HAJEK
21 cm, 8 ¼" 140 g
33700-08

Scharfe Löffel
Bone Currettes
Cucharillas cortantes

Fig.	SPRATT
0000	33474-96
000	33474-97
00	33474-98
0	33475-00
1	33475-01
2	33475-02
3	33475-03
4	33475-04
5	33475-05
6	33475-06

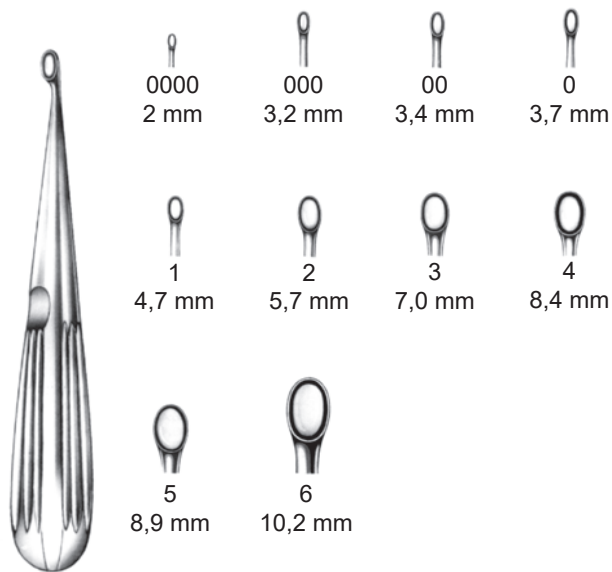

SPRATT
17 cm, 6 ¾"



LEMPERT
17,5 cm, 7"



Fig.	0	33490-10	3,3 mm
	00	33490-20	3,0 mm
	000	33490-30	2,7 mm
	0000	33490-40	2,4 mm
	00000	33490-50	2,0 mm



JANSEN
33495-16 16 cm, 6 ¼"

5.2 mm

3.5 mm

Scharfe Löffel
Bone Currettes
Cucharillas cortantes



BARTH
33393-18, 18 cm, 7"



HALLE
21 cm, 8 1/4"

Fig.
1 33476-01 4,8 mm
2 33476-02 5,8 mm
3 33476-03 6,8 mm

biegsam
malleable
maleable

Fig. VOLKMANN
0000 33469-96
000 33469-97
00 33469-98
0 33470-00
1 33470-01
2 33470-02
3 33470-03
4 33470-04
5 33470-05
6 33470-06



VOLKMANN
17 cm, 6 3/4"

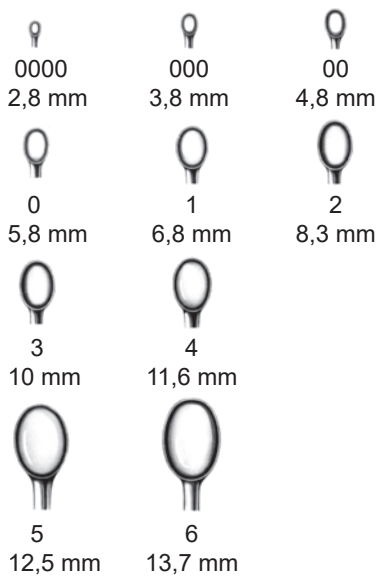

Scharfe Löffel
Bone Curettes
Cucharillas cortantes

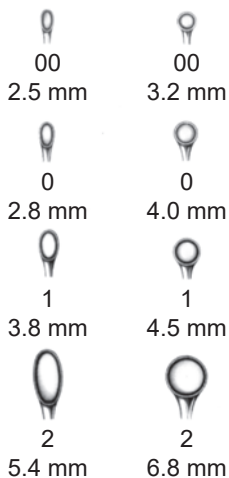

WILLIGER	Fig. 00	33485-99	33486-99
17,5 cm, 7"	0	33486-00	33487-00
	1	33486-01	33487-01
	2	33486-02	33487-02

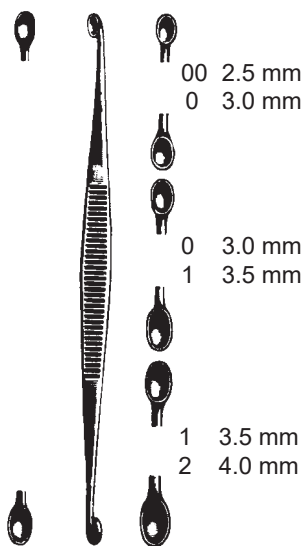

WILLIGER	
13,5 cm, 5 1/4"	Fig.
33496-00	00/0
33496-01	0/1
33496-12	1/2

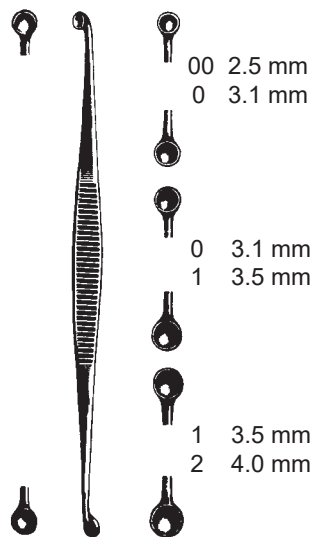

MARTINI	
13,5 cm, 5 1/4"	Fig.
33498-00	00/0
33498-01	0/1
33498-12	1/2

Hohlmeißelzangen
Bone Rongeurs
Pinzas-gubias

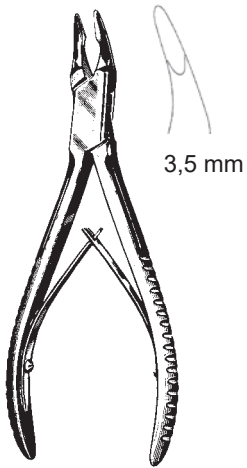

BLUMENTHAL
33115-15
15,5 cm, 6"

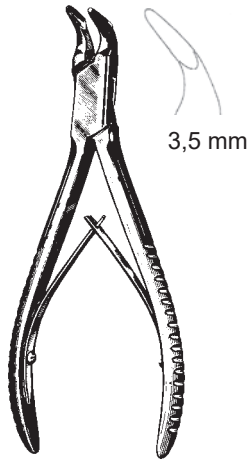

BLUMENTHAL
33117-15
15,5 cm, 6"

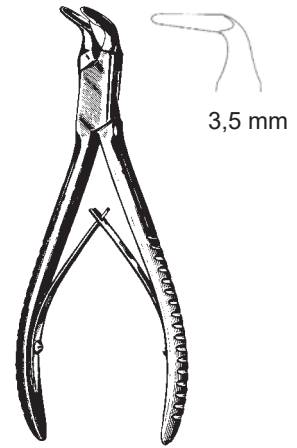

BLUMENTHAL
33119-15
15,5 cm, 6"



LUER
33131-15
15 cm, 5.9"

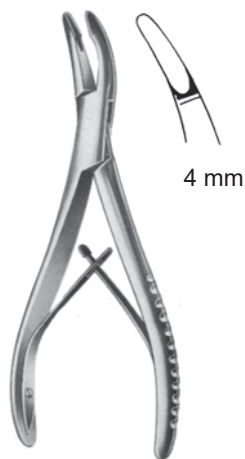

LUER
33133-15
15 cm, 5.9"

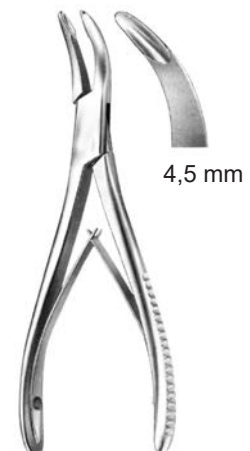

BANE-HARTMANN
33148-18
17,5 cm, 7"

Hohlmeißelzangen
Bone Rongeurs
Pinzas-gubias



— LEMPERT —
33150-16 33151-16
16 cm, 6 1/4"



BEYER
33156-18
18 cm, 7"

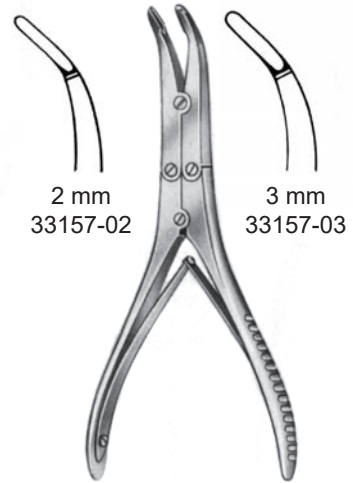

KLEINERT-KUTZ
15 cm, 6"



BEYER
33201-18
18 cm, 7"



ZAUFAL-JANSEN
33205-18
18 cm, 7"



— BÖHLER —
33211-15 33213-15
15 cm, 6"

Knochensplitterzangen
Bone Cutting Forceps
Pinzas cortantes para huesos



— BÖHLER —
33280-15 33281-15
15 cm, 6"



COTTLE-KAZANJIAN
33282-19
19 cm, 7 ½"



MC INDOE
33283-17
17 cm, 6 ¾"

Knochenstanzen
Bone Punches
Pinzas sacabocado



KERRISON
3x3 mm 47303-03
4x4 mm 47303-04
5x5 mm 47303-05
6x6 mm 47303-06
17 cm, 6 3/4"



CITELLI
47311-10 1,0 mm
47311-25 2,5 mm
47311-30 3,0 mm

Wundsperrer
Retractors
Separadores

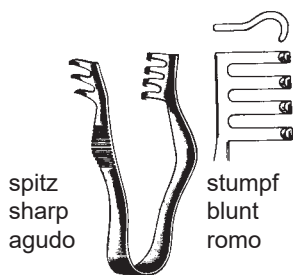

FINSEN
19610-07 7 cm, 2 3/4" 19611-07

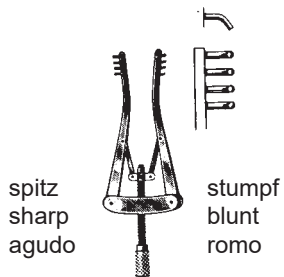

ALM
19620-07 7 cm, 2 3/4" 19621-07
19620-10 10 cm, 4" 19621-10

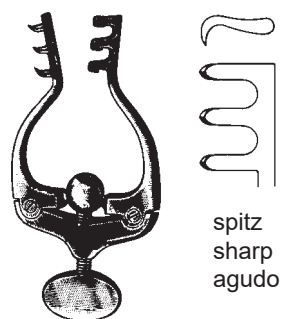

JANSEN
19630-10
10 cm, 4"

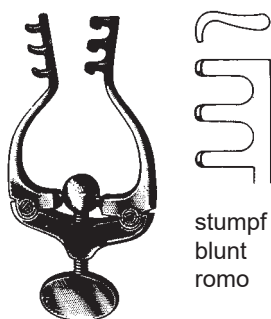

JANSEN
19631-10
10 cm, 4"

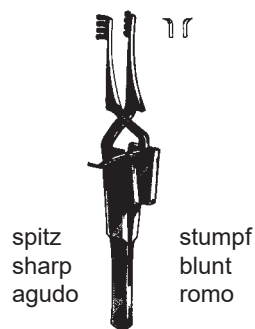

HOLZHEIMER
19634-10 19635-10
10 cm, 4"

Wundsperrer
Retractors
Separadores

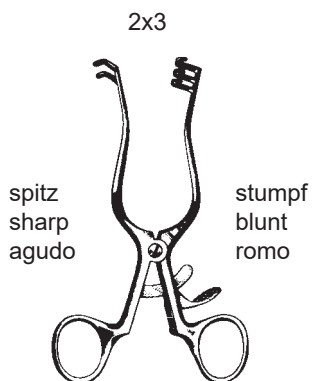

WEITLANER
19650-10 19651-10
11,5 cm, 4 ½"

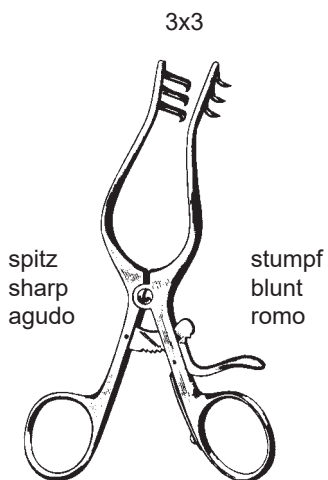

WEITLANER-WULLSTEIN
19654-13 19655-13
13 cm, 5 ⅛"

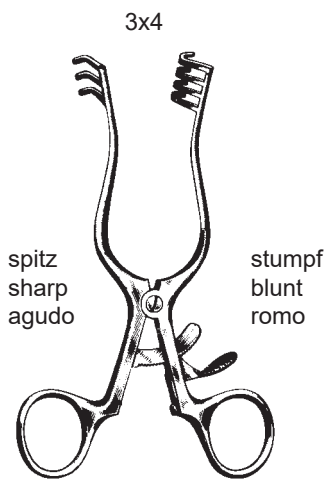

WEITLANER
19670-14 14,0 cm, 5 ½" 19671-14
19670-16 16,5 cm, 6 ½" 19671-16

Wundsperrer
Retractors
Separadores

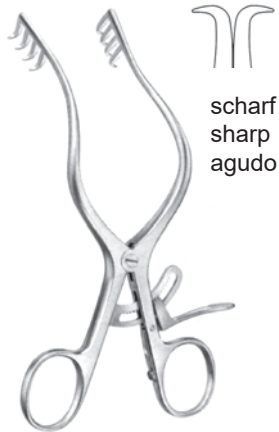

scharf
sharp
agudo

MOLLISON
19674-15
15 cm, 6"



stumpf
blunt
romo

FISCH
19683-17
17 cm, 6 3/4"

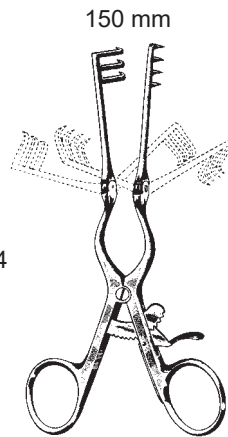

150 mm

19684-14

spitz
sharp
agudo

19685-14

stumpf
blunt
romo

ADSON
14 cm, 5 1/2"

Wundsperrer
Retractors
Separadores

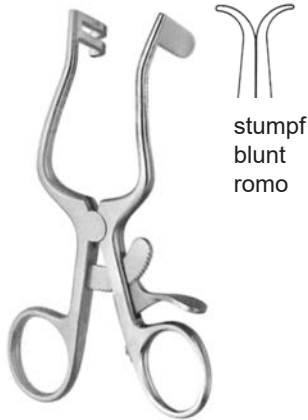

stumpf
blunt
romo

PLESTER
19672-11
11 cm, 4 3/8"

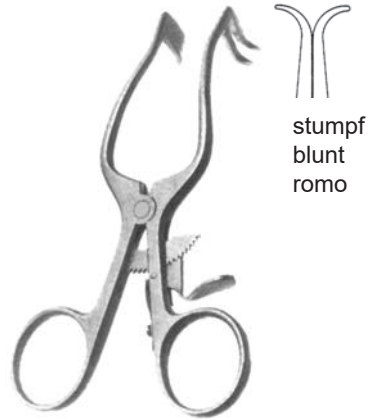

stumpf
blunt
romo

PLESTER
19673-11
11 cm, 4 3/8"

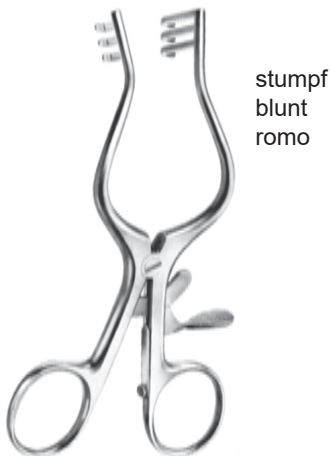

stumpf
blunt
romo

WULLSTEIN
19675-13
13 cm, 5 1/4"

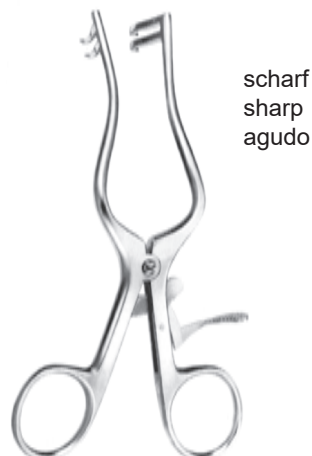

scharf
sharp
agudo

PLESTER
19677-10 10 cm, 4"
19677-13 13 cm, 5 1/8"

Wundhaken
Retractors
Separadores



19283-01
gerade
straight
recto

WILLIGER
12 cm, 4 $\frac{3}{4}$ "



19283-02

links gebogen
left curved
curvado hacia la izquierda



19283-03

rechts gebogen
right curved
curvado hacia la derecha

Präparierscheren
Dissecting Scissors
Tijeras de disección



METZENBAUM
09280-15 **09284-15 TC**
15 cm 6"



METZENBAUM
09281-15 **09285-15 TC**
15 cm 6"



METZENBAUM FINO
09282-15 **09286-15 TC**
15 cm 6"



METZENBAUM FINO
09283-15 **09287-15 TC**
15 cm 6"

Präparierscheren
Dissecting Scissors
Tijeras de disección



— JOSEPH —
09304-14 14 cm 09305-14
5 ½"



— STRABISMUS —
09370-11 09371-11
09374-11 TC 09375-11 TC
11 cm, 4 ¾"

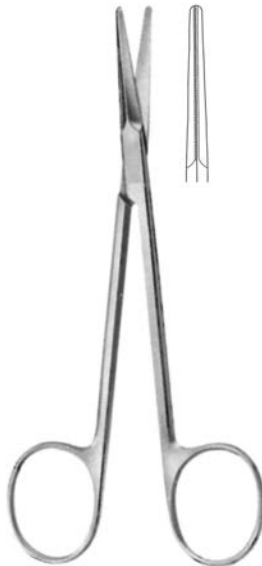

GORNEY
10050-12
12,5 cm, 5"

Chirurgische Scheren
Operating Scissors
Tijeras para cirugía



STANDARD
09110-11 11,5 cm, 4 1/2"
09110-13 13,0 cm, 5"
09110-14 14,5 cm, 5 3/4"



STANDARD
09111-11 11,5 cm, 4 1/2"
09111-13 13,0 cm, 5"
09111-14 14,5 cm, 5 3/4"

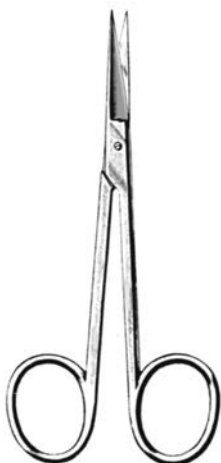

IRIS
11 cm, 4 3/8"



09340-11
09344-11 TC

gerade
straight
rectas



09341-11
09345-11 TC

gebogen
curved
curvas

Draht-, Blehschere
Wire and Plate Scissors
Tijeras para alambre y láminas



UNIVERSAL

09831-12 12 cm, 4 3/4"
09835-12 TC 12 cm, 4 3/4"

Mikro Scheren
Micro Scissors
Micro-Tijeras

10 mm

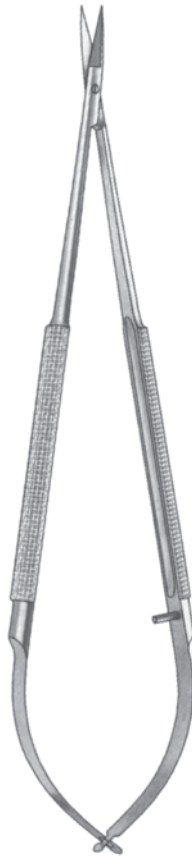

10202-14

14,5 cm, 5 ³/₄"

10203-14

Messer
Knives
Cuchillos

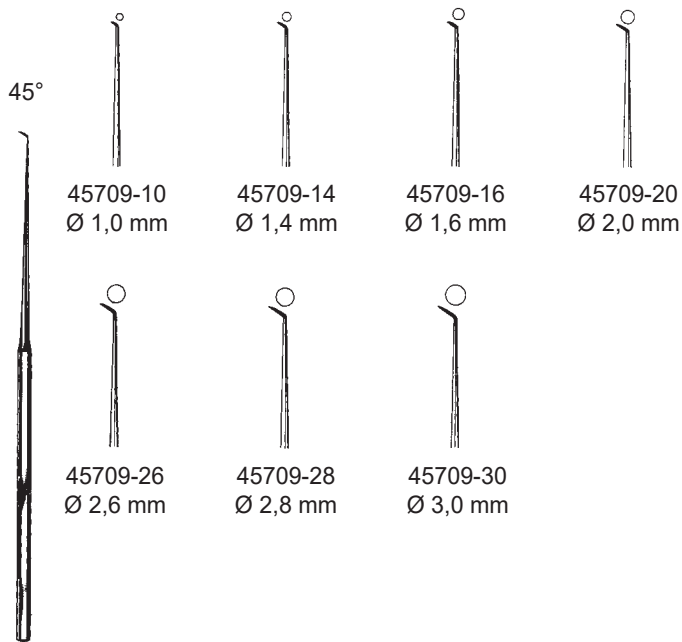

ROSEN
16 cm, 6 ¼"

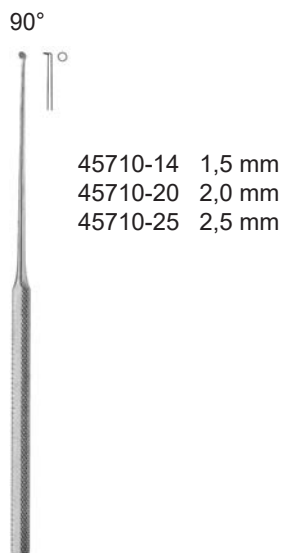

ROSEN
16 cm, 6 ¼"

Messer
Knives
Cuchillos

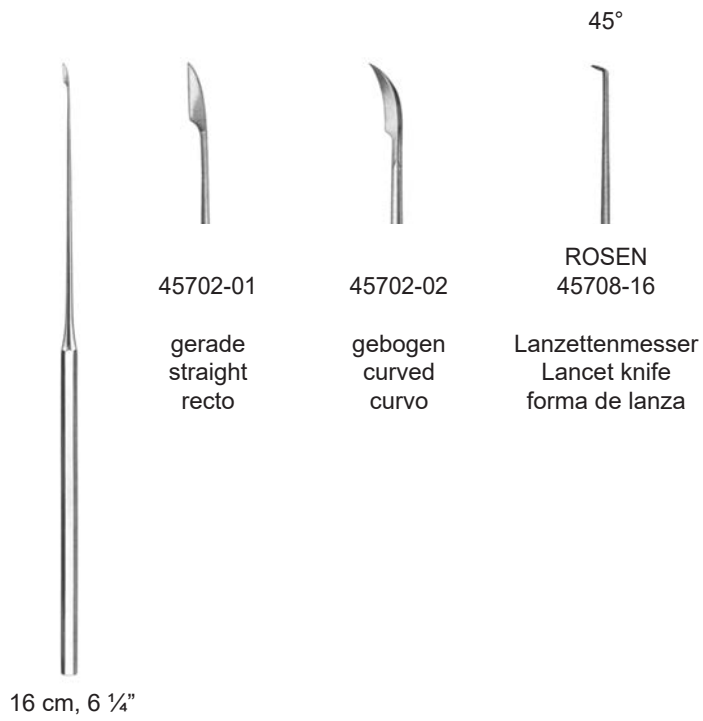

Messer
Knives
Cuchillos



SCHUKNECHT
45701-01
16 cm, 6 1/4"



SCHUKNECHT
45701-02
16 cm, 6 1/4"



SCHUKNECHT
45703-15
15,5 cm, 6"



WULLSTEIN
45704-15
15,5 cm, 6"



TABB
45705-15
15,5 cm, 6"



PLESTER
45706-35
15,5 cm, 6"

Mikro Nadelhalter
Micro Needle Holders
Micro-porta-agujas



BARRAQUER

ohne Sperre
without lock
sin cremallera

mit Sperre
with lock
con cremallera



11,5 cm, 4 1/2"
13,0 cm, 5 1/8"
14,0 cm, 5 1/2"
18,0 cm, 7"

25660-12
25660-13
25660-14
25700-18

25661-12
25661-13
25661-14
25701-18

25720-12
25720-13
25720-14
25730-18

25731-12
25731-13
25731-14
25731-18

mit diamantiertem Maul
with diamond jaw
con boca de diamante

11,5 cm, 4 1/2"
13,0 cm, 5 1/8"
14,0 cm, 5 1/2"
18,0 cm, 7"

25720-12D 25671-12D
25720-13D 25671-13D
25720-14D 25671-14D
25730-18D 25731-18D

T= Titan, titanium, titanio



15,0 cm, 6"
18,0 cm, 7"

93250-15T	93251-15T	93260-15T	93261-15T
93250-18T	93251-18T	93260-18T	93261-18T

Mikro Nadelhalter mit Sperre
 Micro Needle Holders, with Lock
 Micro-porta-agujas con cremallera



CASTROVIEJO



14,0 cm, 5 ½"
 18,0 cm, 7"

25670-14
 25670-18

25671-14
 25671-18

25672-14
 25672-18

25673-14
 25673-18

mit TC 1,4 mm
 with TC jaw 1,4 mm
 con TC 1,4 mm

14,0 cm, 5 ½"
 18,0 cm, 7"

25674-14
 25674-18

25675-14
 25675-18

25676-14
 25668-18

25677-14
 25691-18

mit diamantiertem Maul 0,8 mm
 with diamond jaw 0,8 mm
 con boca de diamante 0,8 mm

14,0 cm, 5 ½"
 18,0 cm, 7"

25672-14D
 25672-18D

25673-14D
 25673-18D

T= Titan, titanium, titanio
 Maul / jaw / boca 0,4mm

14,0 cm, 5 ½"
 18,0 cm, 7"

25672-14T
 25672-18T

25673-14T
 25673-18T

Saugrohre
Suction Tubes
Tubos de aspiración

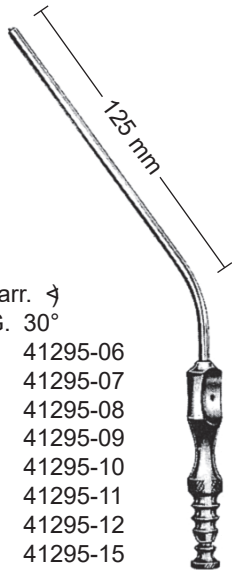

- Charr. ↵
F.G. 30°
- 6 41295-06
 - 7 41295-07
 - 8 41295-08
 - 9 41295-09
 - 10 41295-10
 - 11 41295-11
 - 12 41295-12
 - 15 41295-15

FRAZIER/FERGUSSON
19 cm, 7 1/2"

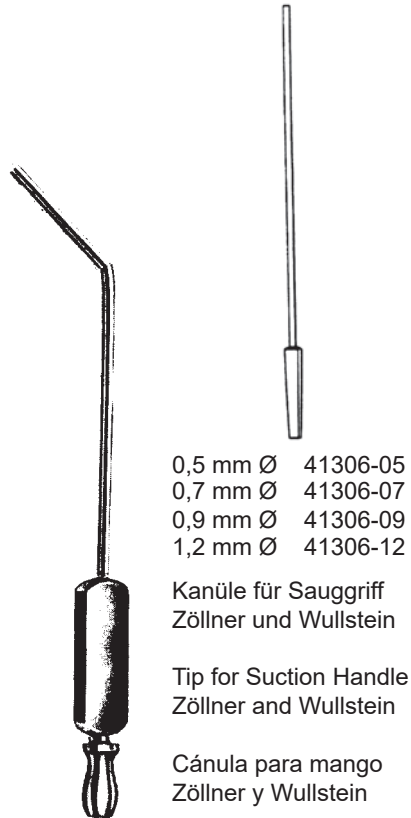

- 0,5 mm Ø 41306-05
- 0,7 mm Ø 41306-07
- 0,9 mm Ø 41306-09
- 1,2 mm Ø 41306-12

Kanüle für Sauggriff
Zöllner und Wullstein

Tip for Suction Handle
Zöllner and Wullstein

Cánula para mango
Zöllner y Wullstein

ZÖLLNER
41302-02

Saugrohre
Suction Tubes
Tubos de aspiración

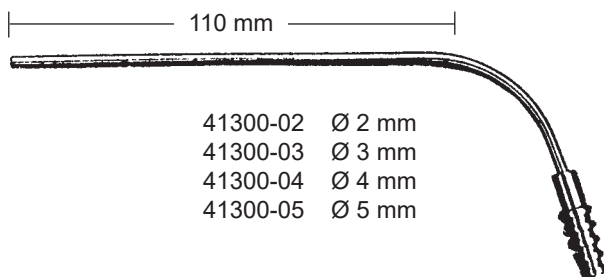

- 41300-02 Ø 2 mm
- 41300-03 Ø 3 mm
- 41300-04 Ø 4 mm
- 41300-05 Ø 5 mm

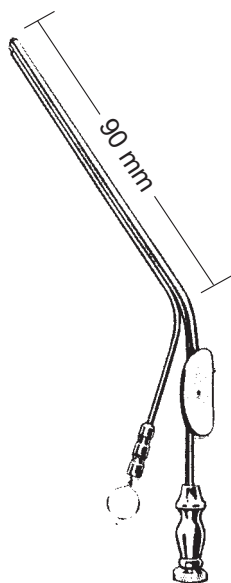

HOUSE

9 cm, 3 1/2"

- 41303-09 Ø 0,9 x 0,7 mm
- 41303-12 Ø 1,2 x 0,9 mm
- 41303-15 Ø 1,5 x 1,2 mm
- 41303-18 Ø 1,8 x 1,8 mm
- 41303-25 Ø 2,5 x 2,0 mm
- 41303-30 Ø 3,0 x 2,0 mm
- 41303-45 Ø 4,5 x 2,0 mm



PLESTER 30°

- Charr. 6 41304-06
- Charr. 8 41304-08
- Charr. 10 41304-10

Saugrohre
Suction Tubes
Tubos de aspiración

Mikro-Saugkanüle
Micro suction cannula
Micro tubo de aspiración

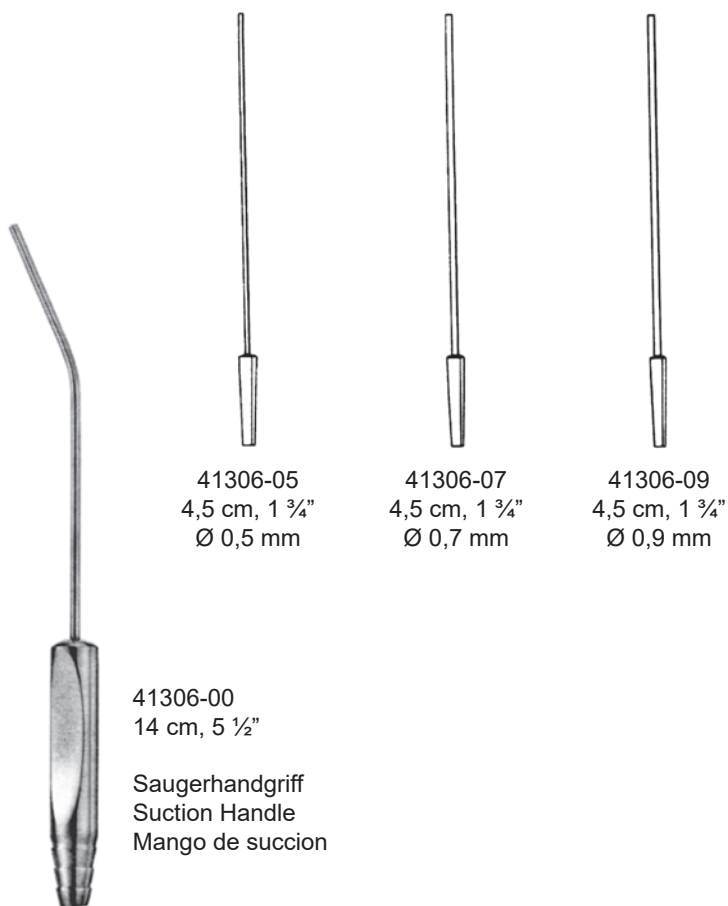

41306-05
4,5 cm, 1 3/4"
Ø 0,5 mm

41306-07
4,5 cm, 1 3/4"
Ø 0,7 mm

41306-09
4,5 cm, 1 3/4"
Ø 0,9 mm

41306-00
14 cm, 5 1/2"
Saugerhandgriff
Suction Handle
Mango de succion

WULLSTEIN
41308-00

komplett, mit Griff und drei Aufsätzen
complete, with handle and 3 tips
completo, con mango y 3 puntas

Saugrohre
Suction Tubes
Tubos de aspiración

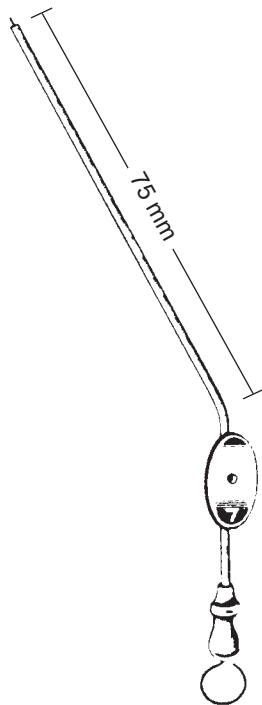

BARON
16 cm, 6 1/4"
41299-03 3FR 1,0 mm
41299-05 5FR 1,6 mm
41299-07 7FR 2,3 mm

Saug- und Spülinstrumente
Aspirating and Irrigation Instruments
Instrumentos de aspiracion y irrigacion

LUER



Sauggriff
Suction Handle
Mango de succion

WULLSTEIN
41307-00

Saugadapter
mit Saugunterbrecher

Suction adapter
with finger cut-off

Adaptador para
aspiración con interrupto

LUER



HOUSE
41300-00
5,5 cm, 2 1/4"

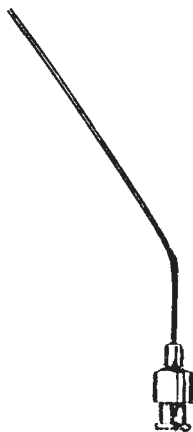

Kanüle für Sauggriff
Tip for Suction Handle
Cánula para mango de succion

ROSEN
10 cm, 4"

0,5 mm Ø 41305-05	1,2 mm Ø 41305-12
0,6 mm Ø 41305-06	1,5 mm Ø 41305-15
0,7 mm Ø 41305-07	1,8 mm Ø 41305-18
0,8 mm Ø 41305-08	2,0 mm Ø 41305-20
0,9 mm Ø 41305-09	2,5 mm Ø 41305-25
1,0 mm Ø 41305-10	3,0 mm Ø 41305-30

Knorpelfeile
Cartilage Files
Limas para el cartilago

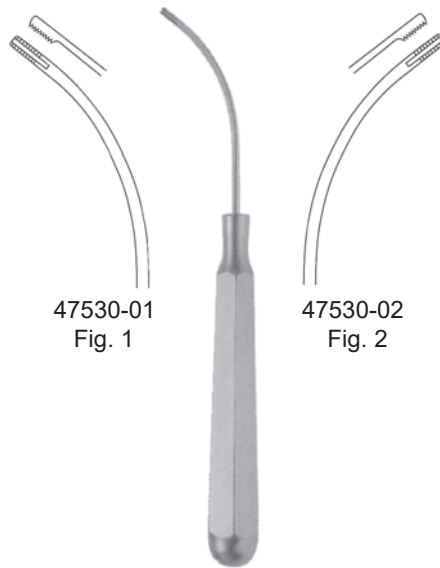

DINGMAN Set
47530-00 15 cm, 6"

Mikro Scheren und Mikro Zangen
 Micro Scissors and Forceps
 Micro tijeras y pinzas

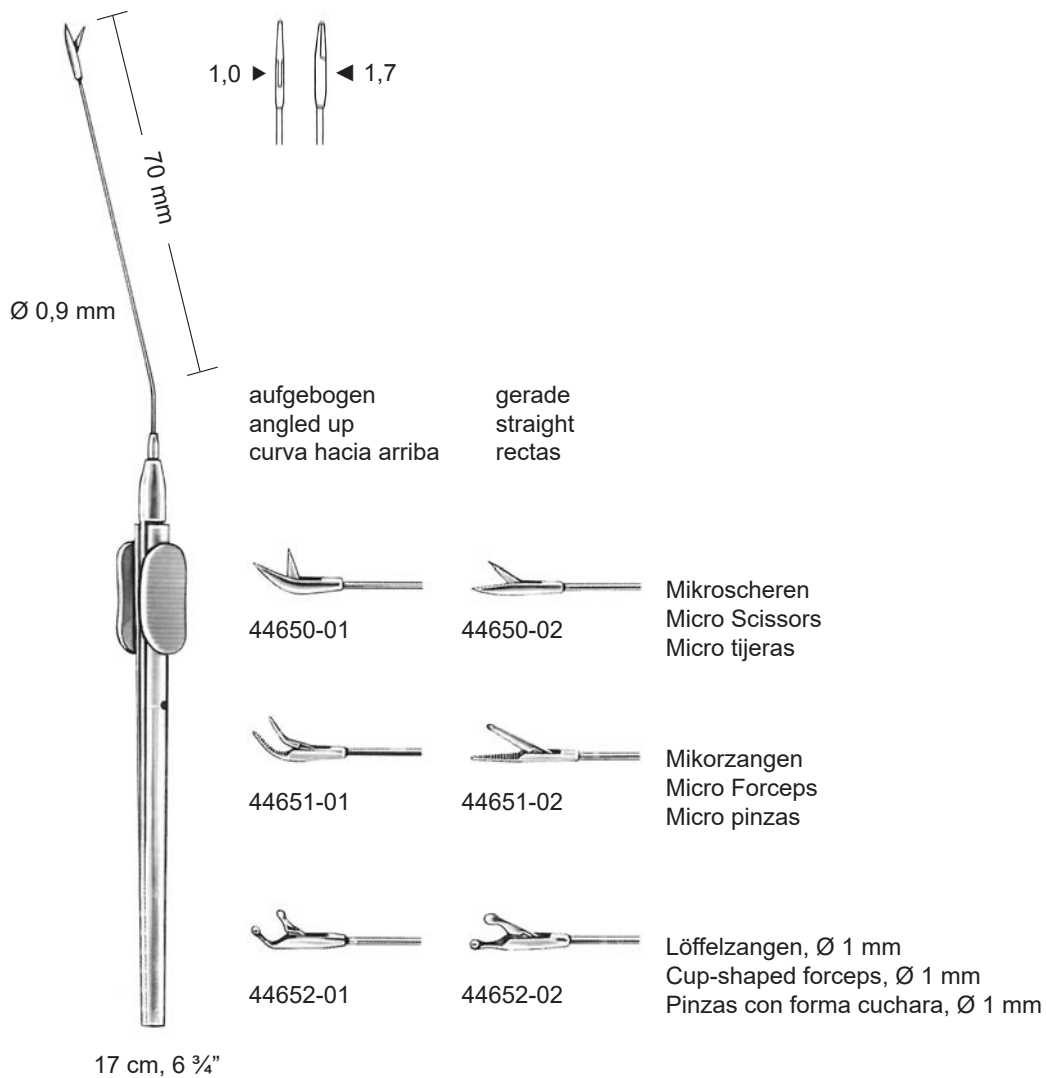

Mikro Meßsonde
Micro Measuring Rod
Sonda para mesurar



HOUSE
16 cm, 6 1/4"



3,5 mm

45766-35



4 mm

45766-40



4,5 mm

45766-45



5 mm

45766-50

Mikro Küretten
Micro Curettes
Micro curetas



mm		
1,0/1,2	45760-01	
1,5/1,8	45760-02	

mm		
1,0/1,2	45762-01	
1,5/1,8	45762-02	

HOUSE
15 cm, 6"

Scharfer Löffel
Sharp Spoon
Cucharilla cortante

1,5 x 2,5 mm



SHEA
45770-01
16 cm, 6 ¼"

Nadeln und Hakchen
Needles and Hooks
Agujas y Ganchos



16 cm, 6 1/4"



BARBARA / ROSEN
45710-15



stumpf
blunt
roma

BARBARA / ROSEN
45711-15



BARBARA / ROSEN
45713-15



BARBARA / ROSEN
45715-17



25°
SHAMBAUGH
mm 0,3 45720-03
0,6 45720-06
1,0 45720-10
1,2
1,5
2,0
2,5



45°
SHAMBAUGH
45722-03
45722-04
45722-06
45722-08
45722-10
45722-12
45722-15
45722-20
45722-25



90°
SHAMBAUGH
45724-03
45724-04
45724-06
45724-08
45724-10
45724-12
45724-15
45724-20
45724-25



BARBARA
45725-05 0,5 mm
45725-10 1,0 mm

Nadeln und Hakchen
 Needles and Hooks
 Agujas y Ganchos

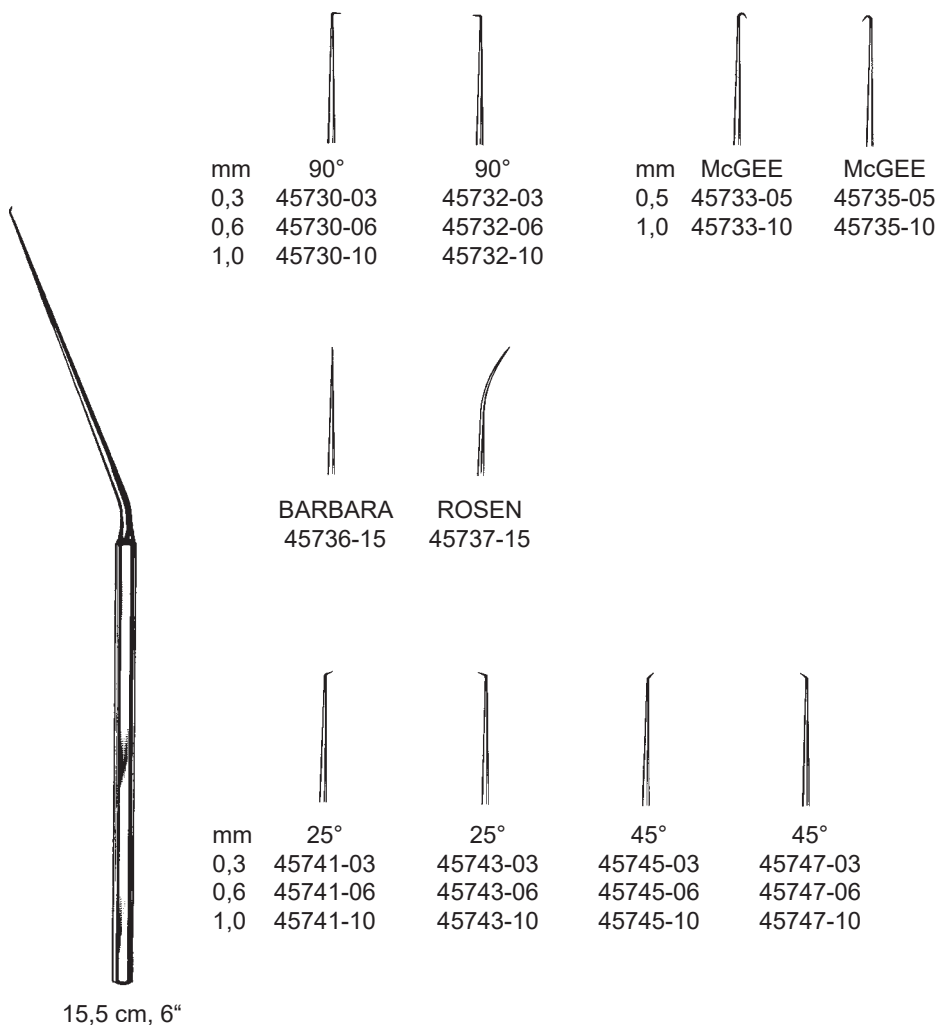

Häkchen
Hooks
Ganchitos



45746-20
abgewinkelt
angled
angulado

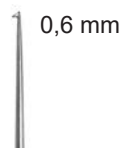

45748-16
retrograd schneidend
reverse cutting
ganchito, corte retrogrado

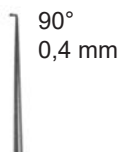

45749-16
abgewinkelt, oval
angled, oval-blunt
angulado, ovalado



45750-16
abgewinkelt, zylindrisch
angled, cylindric
angulado, cilíndrico



45770-16
abgewinkelt, zylindrisch
angled, cylindric
angulado, cilíndrico



45771-16
Führungsgabel
Guide fork
Horquilla de guía



16 cm, 6 1/4"

Elevatorium, Raspatorium, Löffel
 Elevators, Raspatories, Spoon
 Elevadores, Periostótomos, Cucharilla

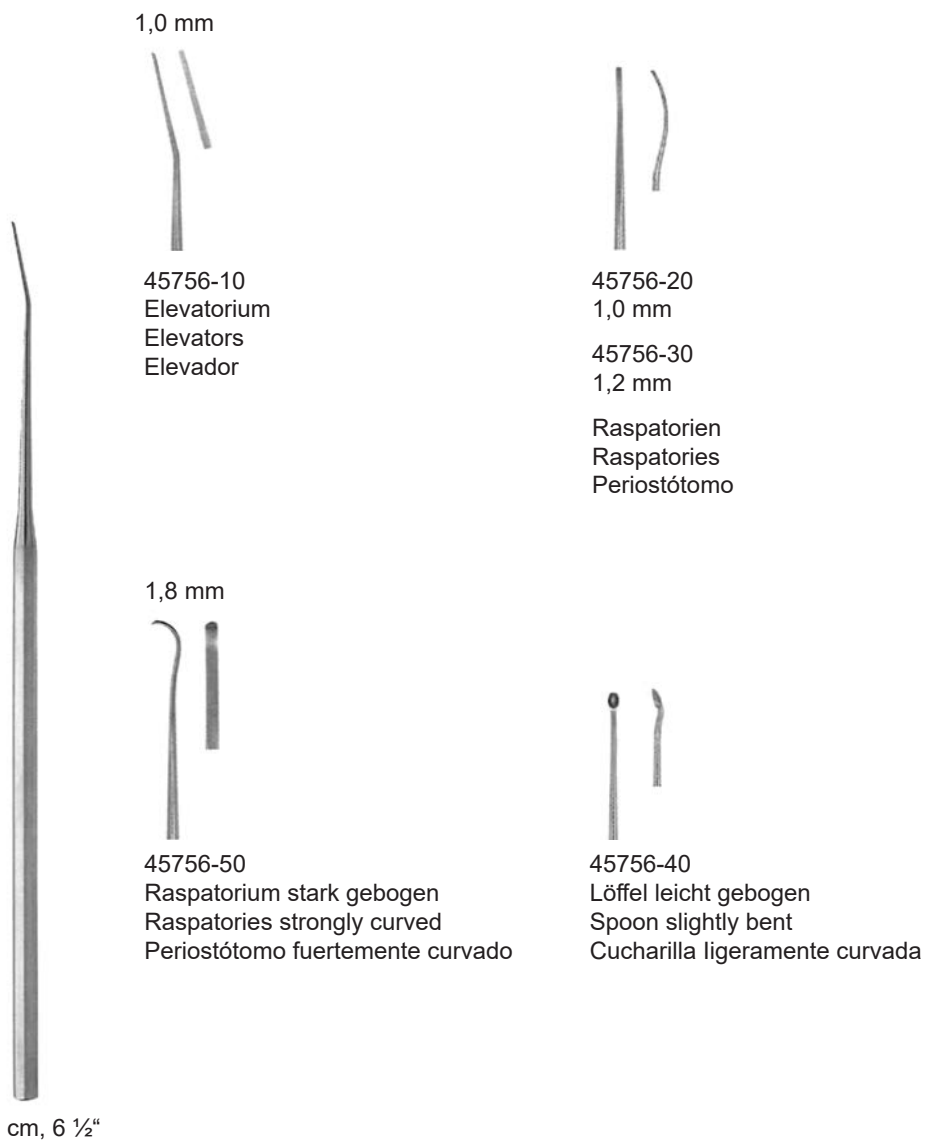

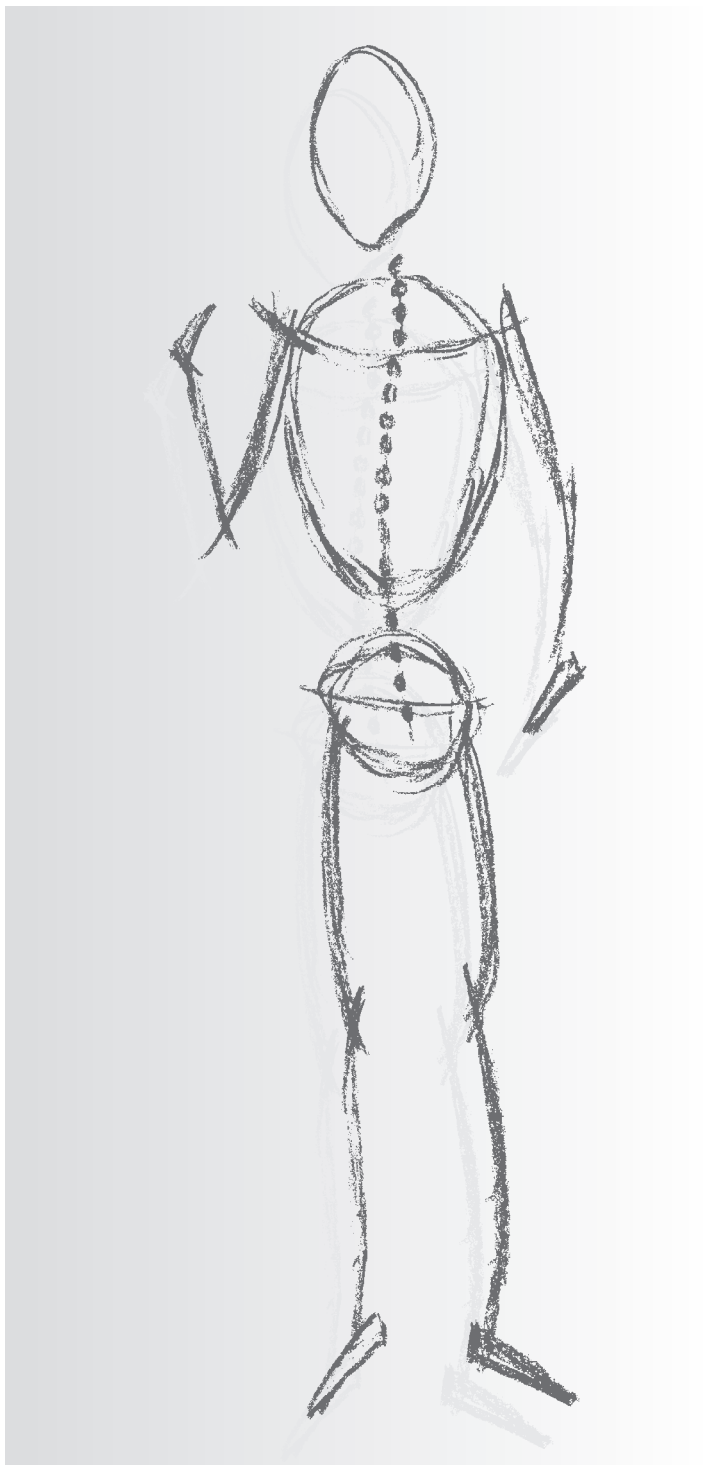

Reda Instrumente GmbH
Gänsäcker 34 - P.O. Box 131
D-78532 Tuttlingen

RHINOLOGIE
SINUSKOPIE

RHINOLOGY
SINUSCOPY

RINOLOGÍA
SINUSCOPIA

Nasenspekula
 Nasal Specula
 Espéculos nasales

selbsthaltend
 self-retaining
 autoestático

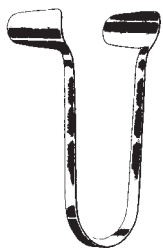

THUDICHUM
 6,5 cm, 2 1/2"



47050-01
 Fig. 1



47050-02
 Fig. 2



47050-03
 Fig. 3

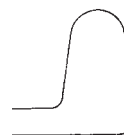

47050-04
 Fig. 4

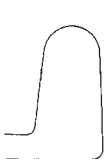

47050-05
 Fig. 5

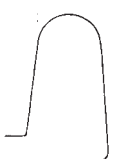

47050-06
 Fig. 6



47050-07
 Fig. 7



47060-01



47060-02



47060-03

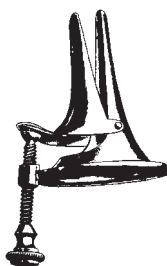

VOLTOLINI

Nasenspekula
Nasal Specula
Espéculos nasales

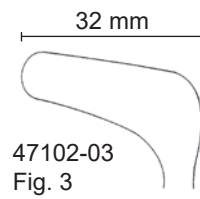
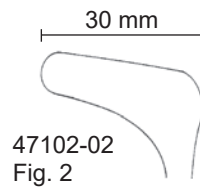
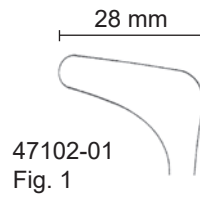

HARTMANN-HALLE
15 cm, 6"

Nasenspekula
Nasal Specula
Espéculos nasales



HARTMANN
16 cm, 6 1/4"

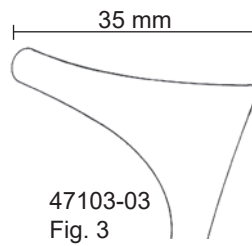
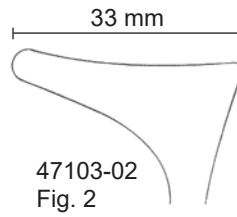
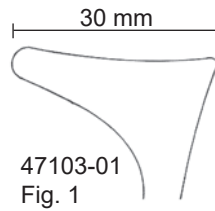

Nasenspekula
Nasal Specula
Espéculos nasales

leichtes Modell
lightweight
modelo ligero

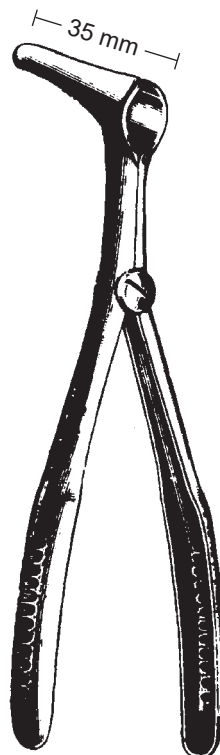
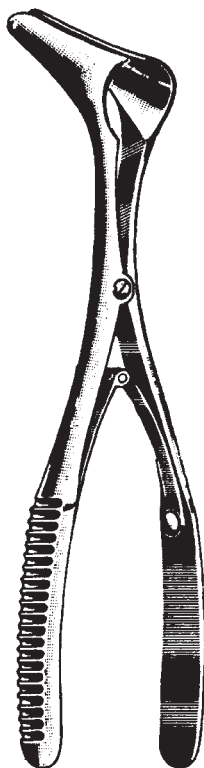

Mod. WIEN
14 cm, 5 1/2"

Mod. WIEN
14 cm, 5 1/2"
47113-03

Baby, bebé	47112-01	25 mm
Kind, child, niño	47112-02	30 mm
Erwachs., adult, adulto	47112-03	35 mm

Nasenspekula
Nasal Specula
Espéculos nasales

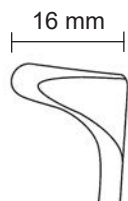

47116-13

für Säuglinge
for babies
para bebés

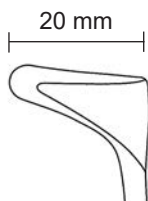

47116-14

für Kleinkinder
for infants
para niños

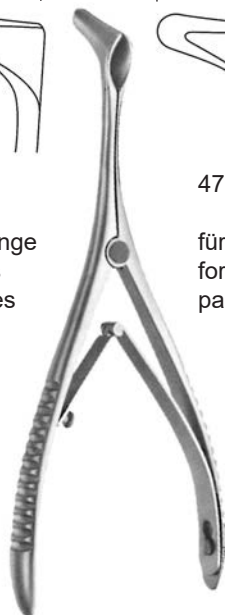

TIECK-HALLE
13,5 cm, 5 3/4"



REDA
47118-13
12,5 cm, 5"



KILLIAN
13 cm, 5 1/8"



47120-35
35 mm

47120-50
50 mm

47120-75
75 mm

47120-90
90 mm

Nasenspekula
Nasal Specula
Espéculos nasales



KILLIAN
13 cm, 5 1/8"

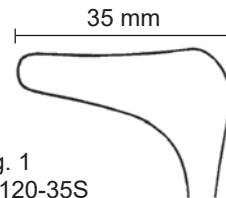

Fig. 1
47120-35S

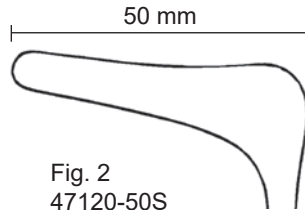

Fig. 2
47120-50S

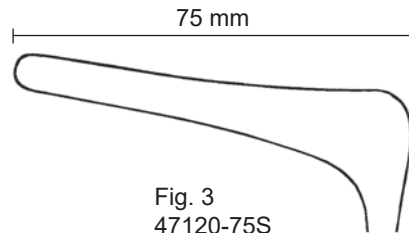

Fig. 3
47120-75S

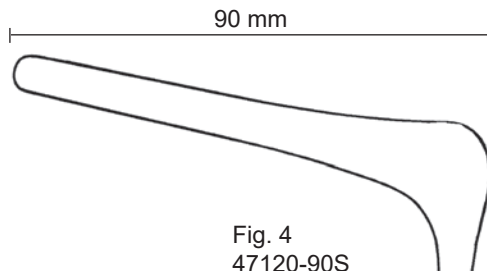

Fig. 4
47120-90S

Nasenspekula
Nasal Specula
Espéculos nasales



COTTLE
14 cm, 5 1/2"

35 mm

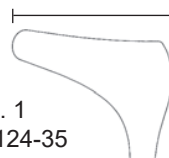

Fig. 1
47124-35

50 mm

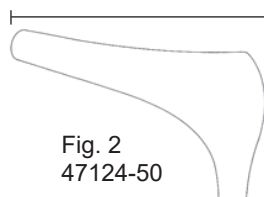

Fig. 2
47124-50

75 mm

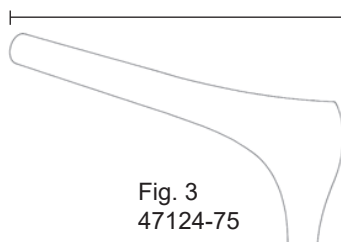

Fig. 3
47124-75

90 mm

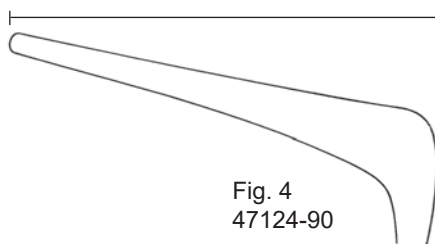

Fig. 4
47124-90

Nasenspekula
Nasal Specula
Espéculos nasales

35 mm

Fig. 1
47124-35S

50 mm

Fig. 2
47124-50S

75 mm

Fig. 3
47124-75S

90 mm

Fig. 4
47124-90S



COTTLE
14 cm, 5 ½"

LEYLA Retraktor System
 LEYLA Retractor System
 Separador de sistema LEYLA



41843-50

Kugelgelenkkloben zum Befestigen an der OP-Tischschiene und zur Aufnahme des Haltearms 41850-41

ball and socket joint for fixation of holding rod 41850-41 at the operating table

articulacion esferica, para sujetar el brazo de soporte rigido sobre la mesa de operaciones 9 x 32 mm



41850-41

starrer Haltearm, auseinandernehmbar, zur Fixation im Kugelgelenkkloben 41843-50 und zur wahlweisen Aufnahme des Kupplungskopf

holding rod, detachable, for fixation in ball and socket joint 41843-50 and to hold a desired coupling head

brazo de soporte rigido, desmontable, para fijacion a la articulacion esferica 41843-50 y opcionalmente a las cabezas

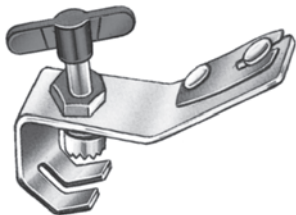

41821-21

Fixiervorrichtung zum Befestigen an Rohrteilen bis Ø 16 mm

clamp for fixation on bars up to Ø 16 mm

dispositivo de fijacion para tubos hasta Ø 16 mm



41842-44

Kupplungskopf, drehbar, zur Aufnahme von 1 flexiblenSpannarm 41810-10

coupling head, turnable, to hold 1 flexible arm 41810-10

acoplamiento, para fijacion de un brazo flexible 41810-10

Nasenpinzetten
Nasal Forceps
Pinzas nasales



TROELTSCH
47151-15
15 cm, 6"

TROELTSCH
47151-18
18 cm, 7"

Nasenpinzetten
Nasal Forceps
Pinzas nasales



JANSEN-GRUENWALD
47154-20
20 cm, 8"

1x2



JANSEN
47155-20
20 cm, 8"

Nasenpinzetten
Nasal Forceps
Pinzas nasales



GRAEFE
11190-10 10,5 cm, 4.1"



McINDOE
11258-15 15,0 cm, 6"
11259-15 TC 15,0 cm, 6"



1x2

GILLIES
11272-15 15,5 cm, 6"
11273-15 TC 15,5 cm, 6"

Nasenpinzetten
Nasal Forceps
Pinzas nasales

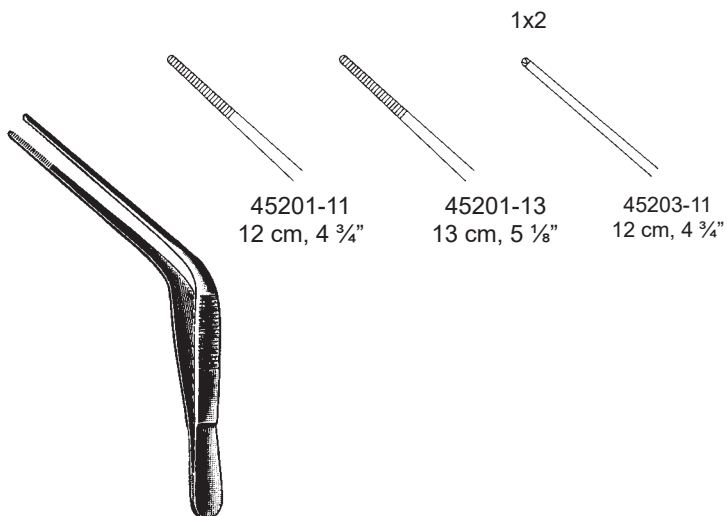

45201-11
12 cm, 4 3/4"

45201-13
13 cm, 5 1/8"

45203-11
12 cm, 4 3/4"

1x2

WILDE (TROELTSCH)



45207-16

LUCAE

45206-14 14 cm, 5 1/2"
45206-16 16 cm, 6 1/4"

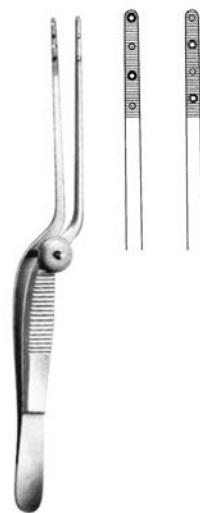

COTTLE

45208-14
14 cm, 5 1/2"

Columella-Pinzette
Columella Forceps
Pinzas para columna

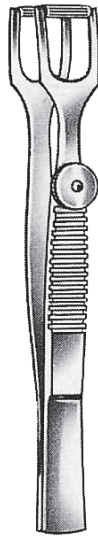

COTTLE
47565-10
10 cm, 4"

Nasentamponzangen
Nasal Dressing Forceps
Pinzas nasales para taponamiento



WESTMACOTT
47158-20 20 cm, 8"



LUBET-BARBON
47159-20 20 cm, 8"



HARTMANN
47161-16 16 cm, 6 1/4"



HARTMANN
47161-20 20 cm, 8"

Nasentamponzangen
Nasal Dressing Forceps
Pinzas nasales para taponamiento



LISTER (Sinus)
17210-13 13 cm, 5 1/8"
17210-16 16 cm, 6 1/4"
17210-18 18 cm, 7"

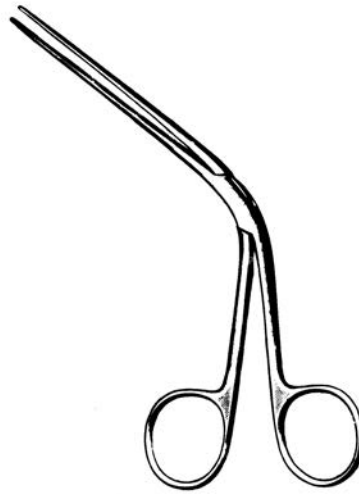

TILLEY
45243-14
14 cm, 5 1/2"

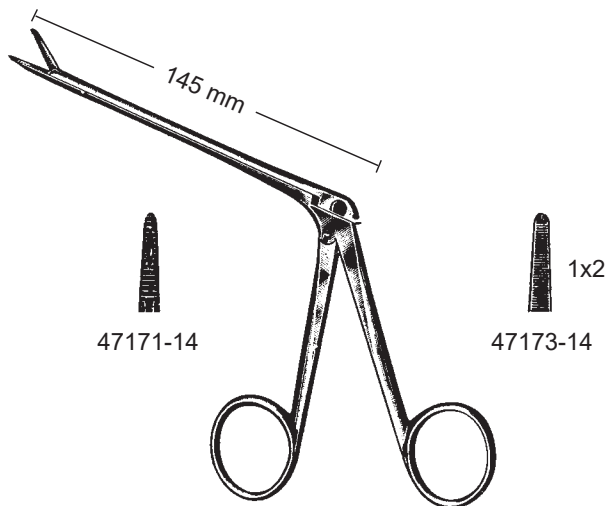

NOYES
14,5 cm, 5 3/4"

Polypenzangen
Nasal Polypus Forceps
Pinzas para pólipos

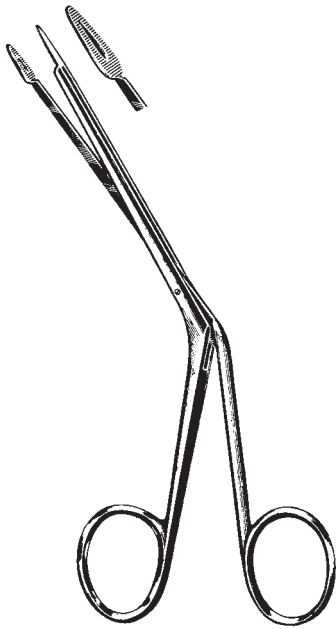

LITTAUER
47167-18
18 cm, 7"



HEYMANN-KNIGHT
47169-18
18 cm, 7"

Nasen Septumzangen
Nasal Septum Forceps
Pinzas para el tabique nasal

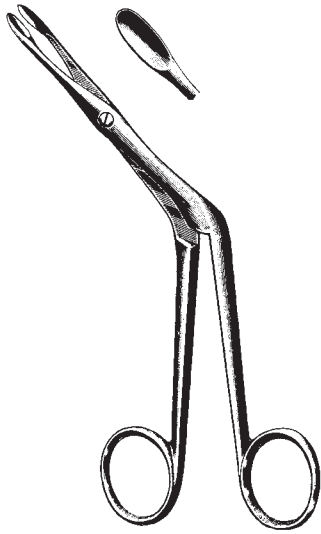

HEYMANN
47181-18
18 cm, 7"



KNIGHT
47185-18
18 cm, 7"



47195-01

47195-02

LUC
19 cm, 7 1/2"

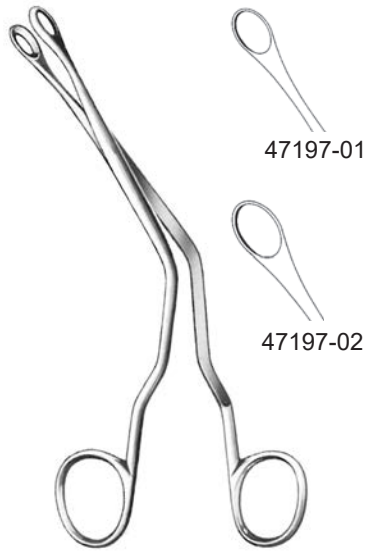

47197-01

47197-02

LUC
19 cm, 7 1/2"

Nasen Septumzangen
 Nasal Septum Forceps
 Pinzas para el tabique nasal



BRUENINGS
 19 cm, 7 1/2"

Vomerzange
 Vomer Forceps
 Pinza para el vómer

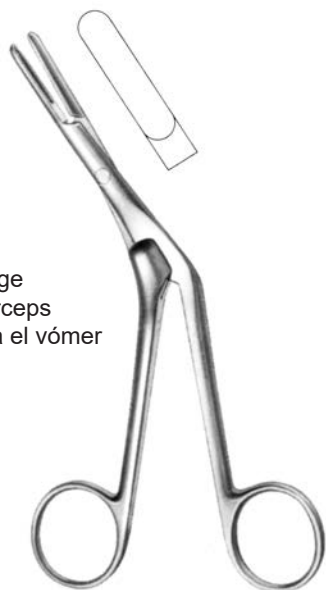

CRAIG
 47192-18
 18 cm, 7"

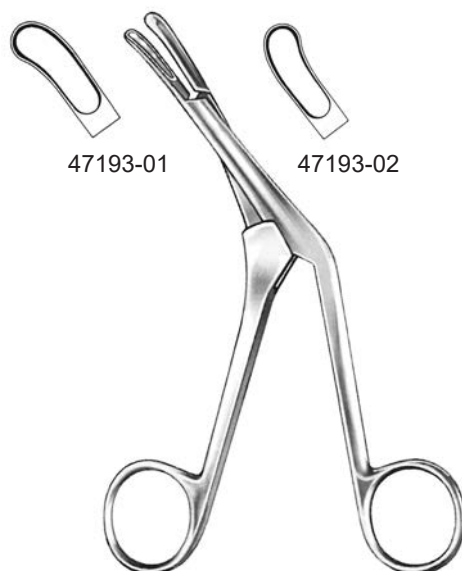

CRAIG-DOMNICK
 17 cm, 6 3/4"

Nasen Septumzangen
Nasal Septum Forceps
Pinzas para el tabique nasal



MIDDLETON-JANSEN
47323-19
19 cm, 7 ½"



MIDDLETON-JANSEN
47325-19
19 cm, 7 ½"

Septumrichtzangen
Septum Straightening Forceps
Pinza para enderezar el tabique nasal



ASCH
47571-23
23 cm, 9"



WALSHAM
47572-23
23 cm, 9"

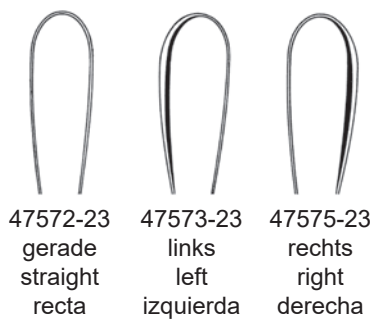

47572-23
gerade
straight
recta

47573-23
links
left
izquierda

47575-23
rechts
right
derecha

Quetschzange
Morselizer Forceps
Pinza para aplastar



RUBIN
47251-21
21 cm, 8 ¼"

Polypenschnürer
Nasal Polypus Snares
Polipótomos



KRAUSE-VOSS
47350-26
26 cm, 10 ¼"



KRAUSE
47351-26
26 cm, 10 ¼"

Polypenschnürer
Nasal Polypus Snares
Polipótomos

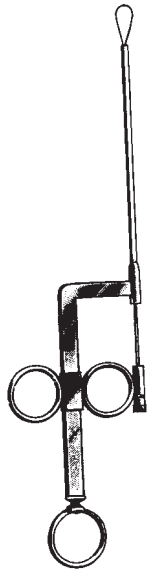

WILDE
47352-24
24 cm, 9 1/2"



Bündel mit 12 Stück
Bundle of 12 pieces
paquete de 12 piezas

47355-03 0,3 mm

Siebbeinzangen
Ethmoid Forceps
Pinzas para etmoides

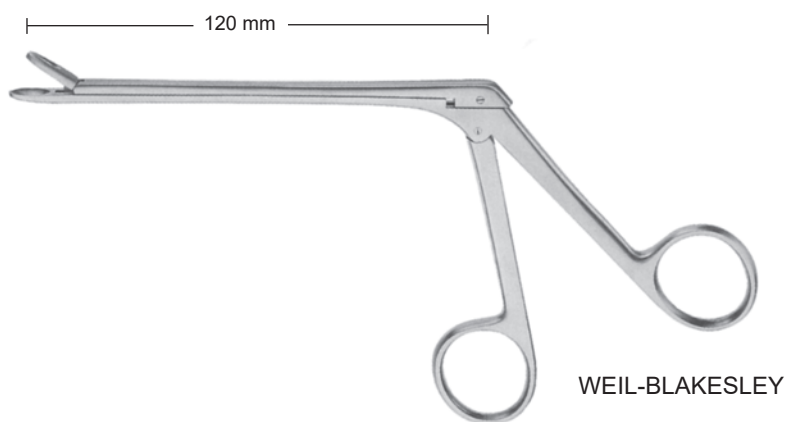
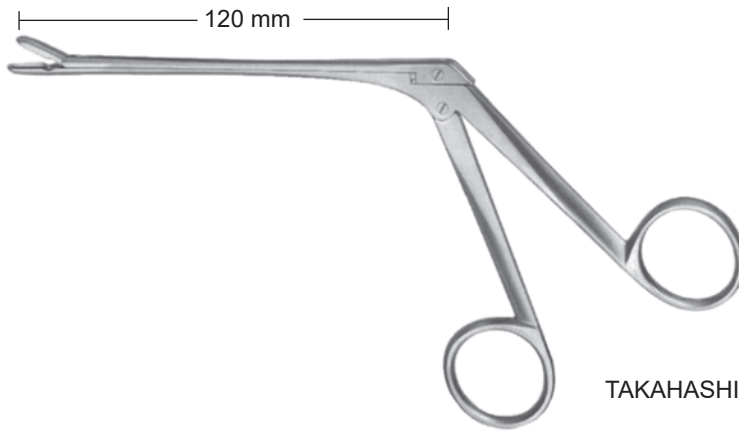

	Fig. 0	Fig. 1	Fig. 2	Fig. 3	Fig. 4	Fig. 5
	47223-00 2,5 mm	47223-01 3,0 mm	47223-02 3,6 mm	47223-03 4,2 mm	47223-04 4,8 mm	47223-05 5,8 mm
	47224-00 2,5 mm	47224-01 3,0 mm	47224-02 3,6 mm	47224-03 4,2 mm	47224-04 4,8 mm	47224-05 5,8 mm
		47225-01 3,0 mm	47225-02 3,6 mm	47225-03 4,2 mm	47225-04 4,8 mm	

Siebbeinzangen
Ethmoid Forceps
Pinzas para etmoides



2,5 mm



47241-00

4 mm



47242-00

4 mm



47242-01

Siebbeinzangen
Ethmoid Forceps
Pinzas para etmoides

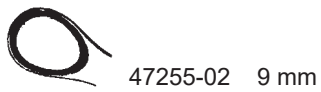
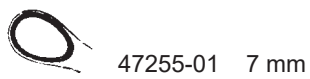
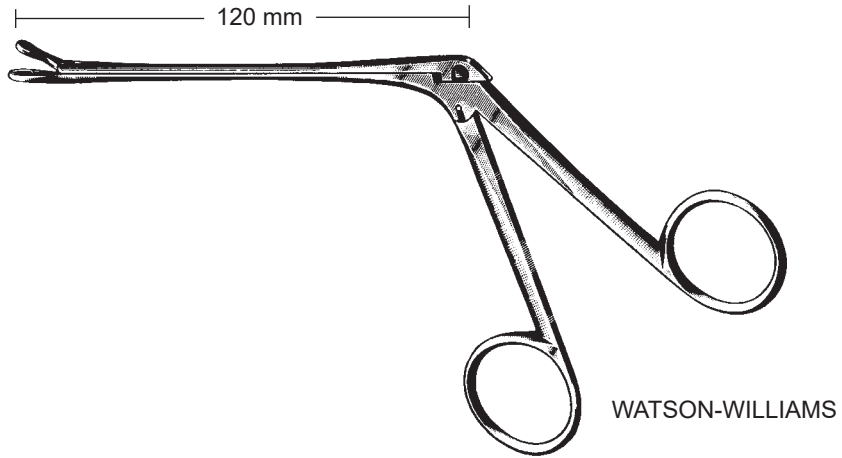

Nasenzange
Nasal Forcep
Pinza nasal

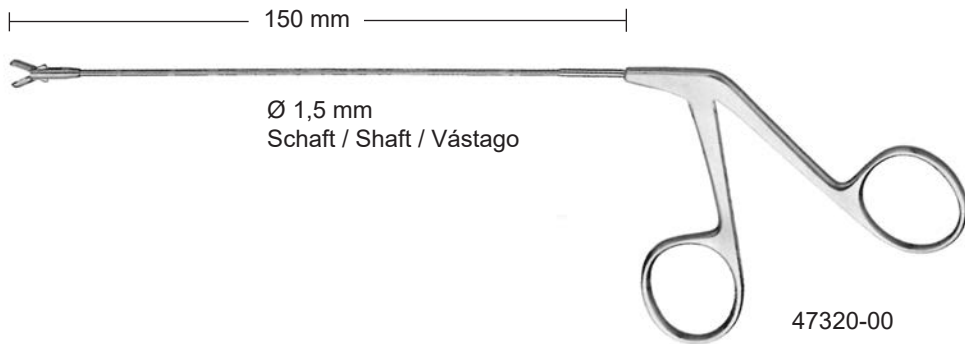

3 x 5 mm



Biopsiezange mit Löffelmaul
Biopsy Forceps with cup jaw
Pinza para biopsia con boca en forma de cucharilla

Nasenzangen, durchschneidend
Nasal Cutting Forceps
Pinzas nasales cortantes

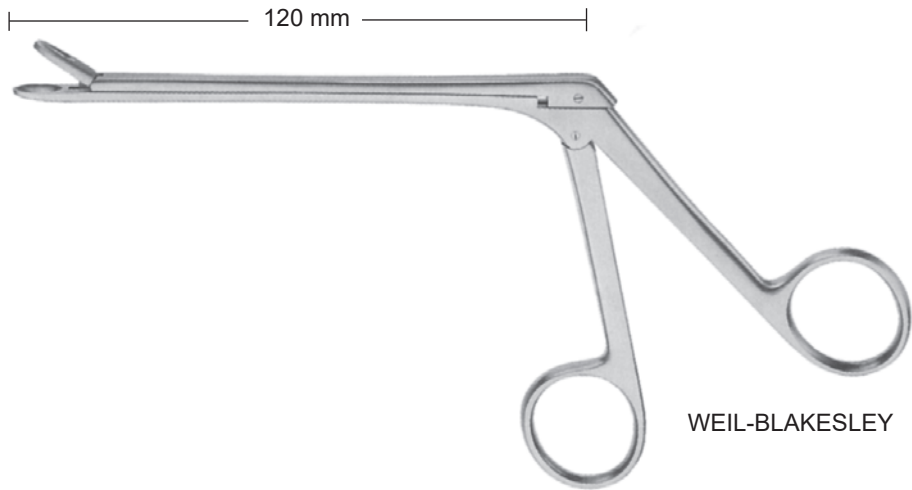

	 47226-01 2,0 mm	 47226-02 2,5 mm	 47226-03 3,0 mm
	 47227-01 2,0 mm	 47227-02 2,5 mm	 47227-03 3,0 mm

Nasenzangen, durchschneidend
Nasal Cutting Forceps
Pinzas nasales cortantes

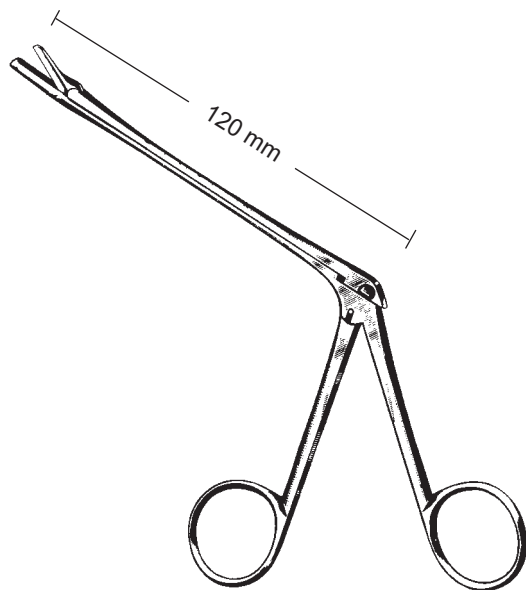

STRUYCKEN
47240-19

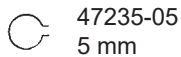

47235-05
5 mm



47235-07
7 mm



47235-09
9 mm



47235-11
11 mm



HARTMANN

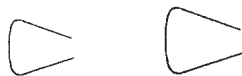

47239-01

47239-02

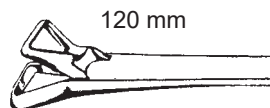

SCHMEDEN

Scharfe Nasenzangen, durchschneidend
 Nasal Cutting Forceps
 Pinzas nasales cortantes

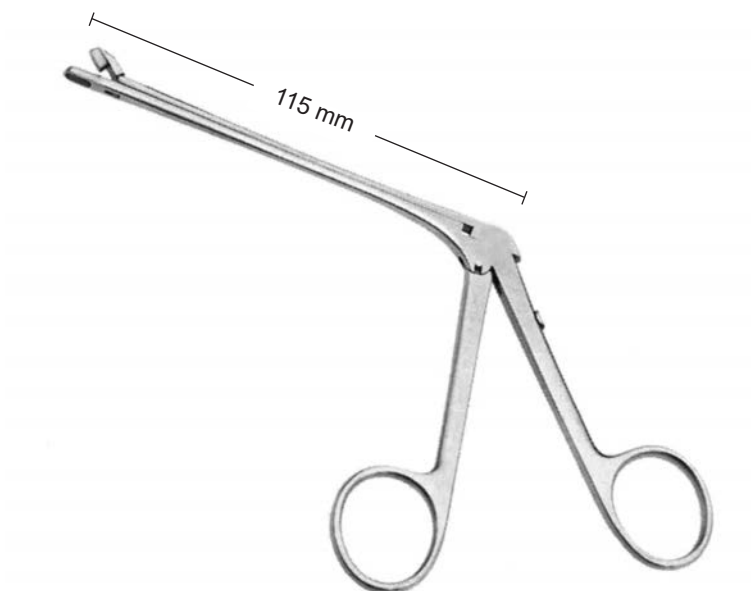

gerade
 straight
 recta



47230-00
 2,7 x 6,8 mm



47230-01
 3 x 7,7 mm

aufgewinkelt
 angled up
 angulada hacia arriba



47230-02
 2,2 x 6,5 mm



47230-03
 2,6 x 6,5 mm



47230-04
 3 x 6,5 mm

fein, gerade
 delicate, straight
 fina, recta



47230-05
 1,4 x 5 mm

fein, aufgewinkelt
 delicate, angled up
 fina, angulada hacia arriba



47230-06
 1,4 x 4 mm

Scharfe Nasenzangen
Nasal Cutting Forceps
Pinzas nasales cortantes

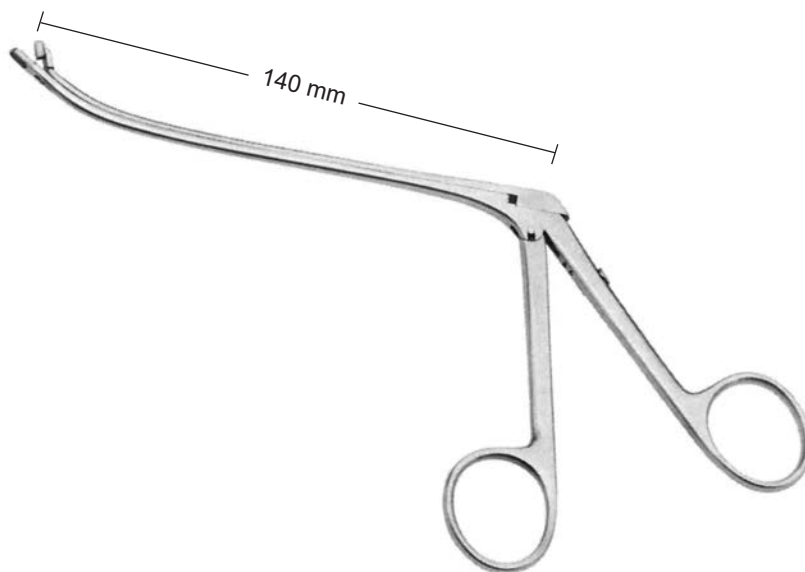

47231-00
3 x 7,4 mm

aufgebogen
curved up
curvada hacia arriba



47231-01
1,4 x 5 mm

fein, aufgebogen
delicate, curved up
fina, curvada hacia arriba



47231-02
1,4 x 4 mm

fein, aufgebogen, gewinkelt
delicate, curved up, angled
fina, curvada hacia arriba, angulada

Scharfe Nasenzange
Nasal Cutting Forcep
Pinza nasal cortante

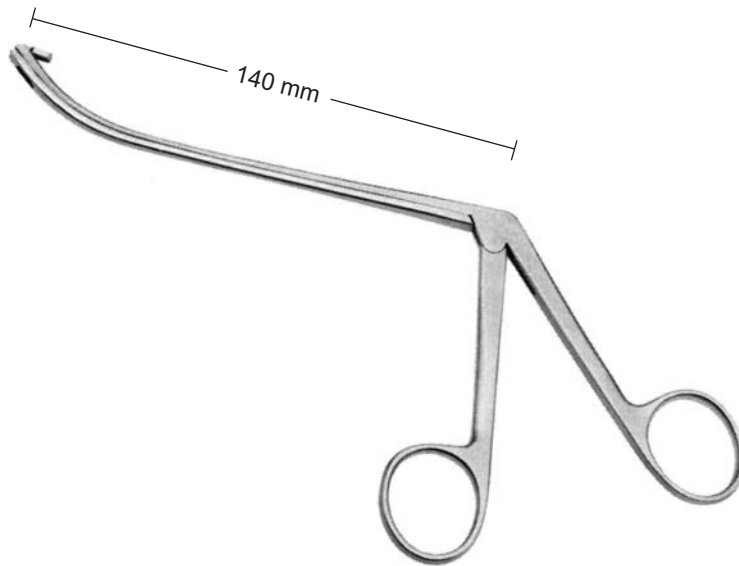

47232-00
2,6 x 4,5 mm

rückwärts schneidend, aufgebogen
backward cutting, curved up
corte retrogrado, curvada hacia arriba

Scharfe Nasenzangen
Nasal Cutting Forceps
Pinzas nasales cortantes



47233-00
3 x 5 mm

fein, gerade
delicate, straight
fina, recta



47233-01
3 x 5 mm

fein, aufgewinkelt
delicate, angled
fina, angulada hacia arriba

Scharfe Nasenzangen
Nasal Cutting Forceps
Pinzas nasales cortantes

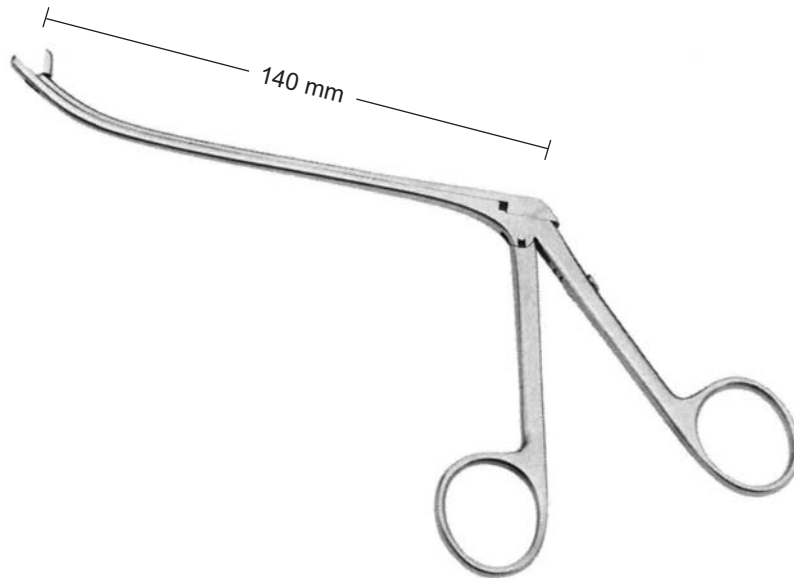

47233-02
4 x 5 mm

aufgebogen
curved up
curvada hacia arriba



47233-03
3 x 5 mm

fein, aufgebogen
delicate, curved up
fina, curvada hacia arriba

Fremdkörperzängchen
Ear Polypus Forceps
Pinzas para pólipos

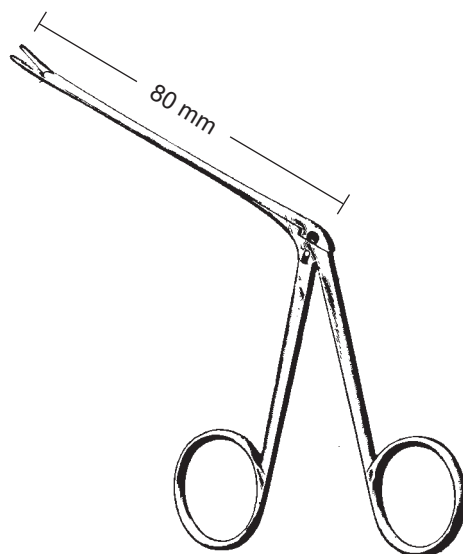

◦ 1 mm Ø



HARTMANN-WULLSTEIN
45257-08
8,5 cm, 3.4"



Ø mm	HARTMANN
2,0	45267-20 8,5 cm, 3.4"
2,5	45267-25 8,5 cm, 3.4"

○ 2 mm Ø



HARTMANN-HOFFMANN
45275-08
8,5 cm, 3.4"

Kieferhöhlen-Fasszange
Maxillary Sinus Forceps
Pinza de agarre para el seno maxilar

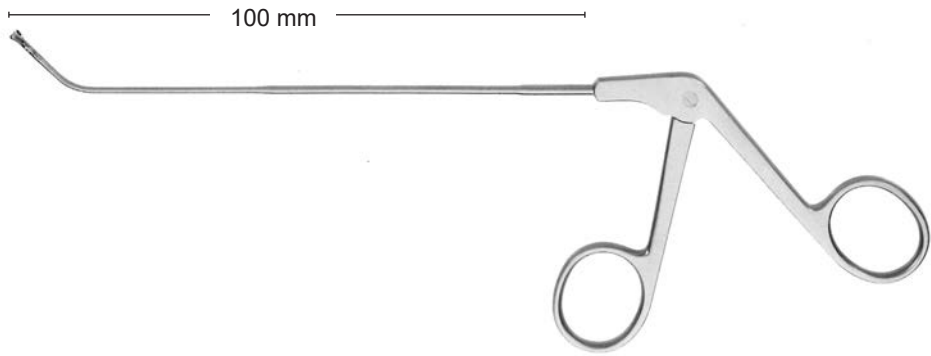

Maulteil starr
Jaw rigid
Boca rigida



47324-01
90° rückwärts öffnend nach unten
90° backward opening downwards
apertura de 90° hacia atrás hacia abajo



47324-02
120° rückwärts öffnend nach unten
120° backward opening downwards
apertura de 120° hacia atrás hacia abajo

Kieferhöhlen-Fasszange
Maxillary Sinus Forceps
Fórceps del seno maxilar

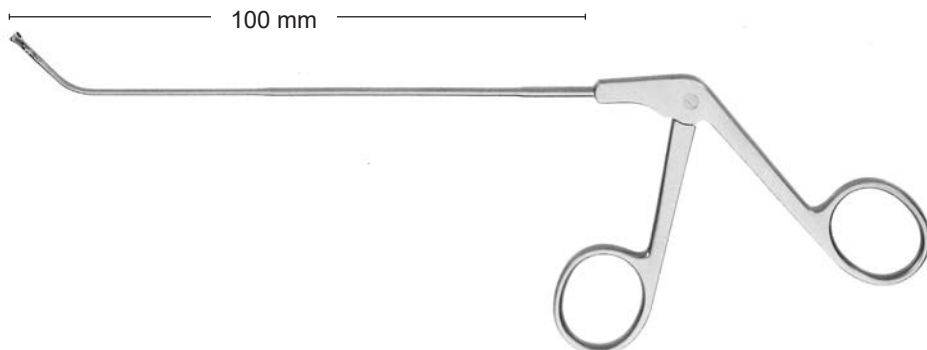

Maulteil starr
Jaw rigid
Boca rigida



47324-05

90° rückwärts öffnend nach oben

90° backward opening top

apertura de 90° hacia atrás hacia arriba



47324-04

90° rückwärts öffnend nach rechts

90° backward opening right

apertura de 90° hacia atrás hacia la derecha



47324-03

90° rückwärts öffnend nach links

90° backward opening left

apertura de 90° hacia atrás hacia la izquierda

Nasenzangen, durchschneidend
 Nasal Cutting Forceps
 Pinzas nasales cortantes

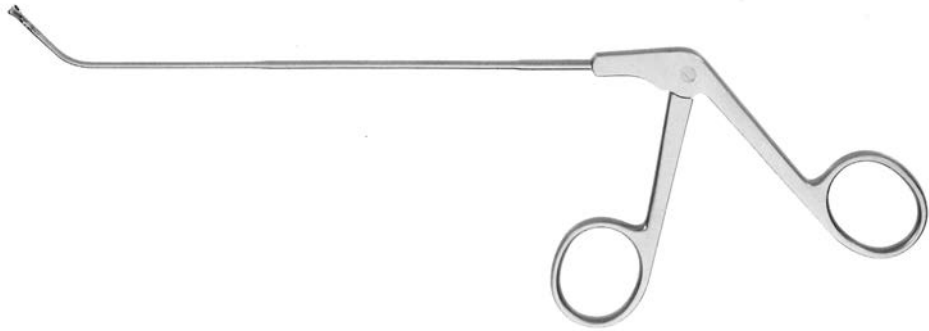

nach oben gebogen
 curved upward
 curvada hacia arriba



Doppellöffel, horizontal öffnend
 Cup, double action horizontal jaw
 Boca en forma cuchara de doble accion, boca horizontal

	70°	90°	110°
Ø 2 mm	47316-70	47316-90	47316-11
Ø 3 mm	47317-70	47317-90	47317-11
Ø 4 mm	47320-70	47320-90	47320-11



Doppellöffel, vertikal öffnend
 Cup, double action vertical jaw
 Boca en forma cuchara de doble accion, boca vertical

	70°	90°	110°
Ø 2 mm	47321-70	47321-90	47321-11
Ø 3 mm	47318-70	47318-90	47318-11
Ø 4 mm	47322-70	47322-90	47322-11





Doppellöffel BUTTERFLY, horizontal öffnend
 BUTTERFLY cup, double action horizontal jaw
 Boca en forma cuchara de doble accion BUTTERFLY,
 boca horizontal

	80°	100°
Ø 3 mm	47323-80	47323-10

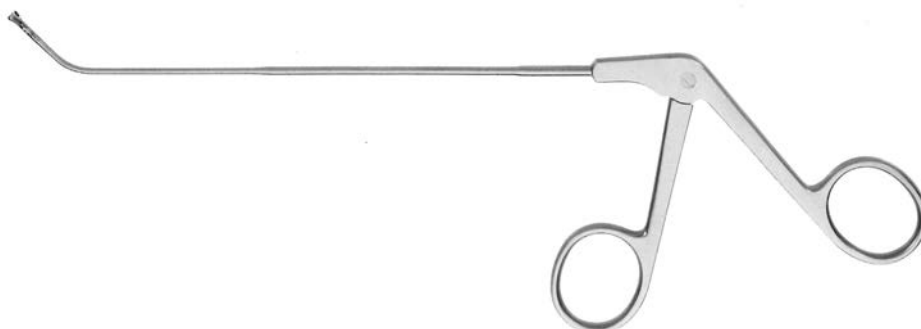
Biopsie Stanze
 Biopsy Punch
 Pinza para biopsia





Biopsie Stanze, Schnitt 2,5 x 5 mm, einfach vertikalen Kiefer
 Biopsy punch, cut 2.5 x 5 mm, single action vertical jaw
 Pinza para biopsia, corte de 2,5 x 5 mm, boca vertical de simple accion

	Schaft Shaft Vástago	vertikal öffnend vertical opening apertura vertical	links öffnend left opening apertura a la izquierda	rechts öffnend right opening apertura a la derecha
 Arbeitslänge 90 mm Working length 90 mm Largo util de 90 mm	70° gebogen curved curvo	47325-01	47325-02	47325-03
 Arbeitslänge 105 mm Working length 105 mm Largo util de 105 mm	gerade straight recto	47326-01	47326-02	47326-03
 Arbeitslänge 105 mm Working length 105 mm Largo util de 105 mm	70° gebogen curved curvo	47327-01	47327-02	47327-03



Nasenzangen, Rohrschaft, einfachbeweglich
 Nasal Forceps, Tube Shaft, single action jaws
 Pinzas nasales, vastago tubular, simple accion

BLAKESLEY Nasenzange, Arbeitslänge 130 mm
 BLAKESLEY nasal forceps, working length 130 mm
 Pinza nasal BLAKESLEY, largo util de 130 mm

Maul gefenstert und gerade
 Jaw fenestrated, straight
 Boca fenestrada y recta





Schnitt / Cut / corte	3,0 mm	3,5 mm	4,0 mm
	47223-30	47223-35	47223-40
	47226-30	47226-35	47226-40

Maul gefenstert und 45° nach oben abgewinkelt
 Jaw fenestrated and 45° angled upwards
 Boca fenestrada y angulada hacia arriba en 45°

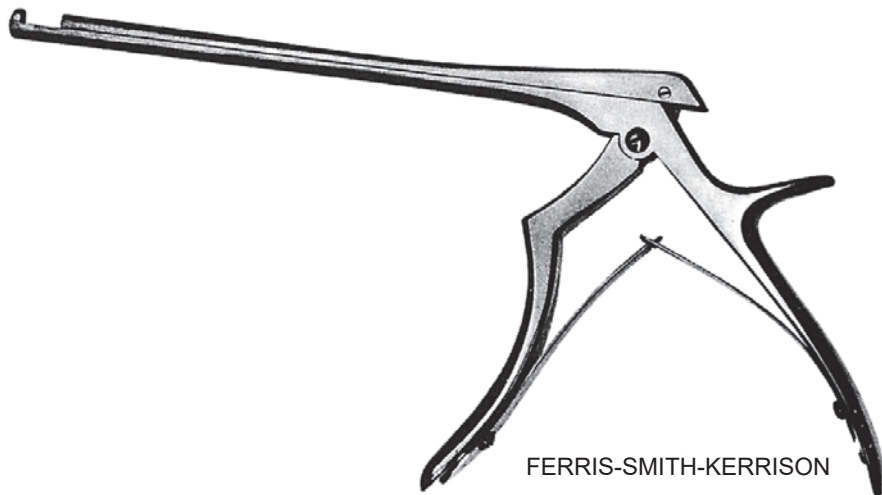
Schnitt / Cut / corte	3,0 mm	3,5 mm	4,0 mm
	47224-30	47224-35	47224-40
	47227-30	47227-35	47227-40

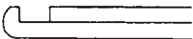
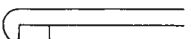
Knochenstanzen
Bone Punch
Pinzas para huesos

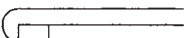
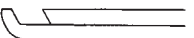

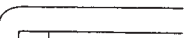
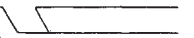
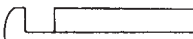
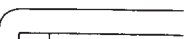
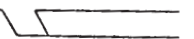
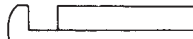
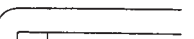
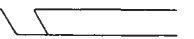
	90°	90°	40°
18 cm, 7"	 41510-01 1 mm	 41511-01 1 mm	 41512-01 1 mm
18 cm, 7"	 41510-02 2 mm	 41511-02 2 mm	 41512-02 2 mm
18 cm, 7"	 41510-03 3 mm	 41511-03 3 mm	 41512-03 3 mm
18 cm, 7"	 41510-04 4 mm	 41511-04 4 mm	 41512-04 4 mm
18 cm, 7"	 41510-05 5 mm	 41511-05 5 mm	 41512-05 5 mm

auch lieferbar mit Dünnfuß
also available with thin foot plate
tambien disponible con lámina de punzonar estrecha

Stanzen
Punches
Pinzas



KERRISON
17 cm, 6 3/4"

- 3x3 mm 47303-03
- 4x4 mm 47303-04
- 5x5 mm 47303-05
- 6x6 mm 47303-06

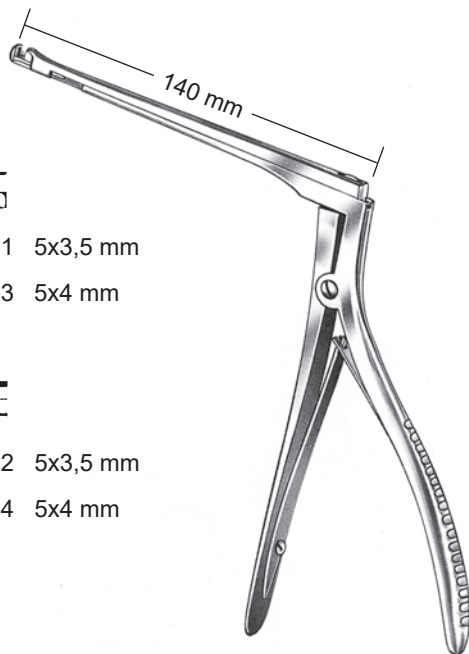

⌒ 47304-01 5x3,5 mm

⌒ 47304-03 5x4 mm



⌒ 47304-02 5x3,5 mm

⌒ 47304-04 5x4 mm

HAJEK-KOFLER

Stanze
Punch
Pinza



HAJEK-KOFLER
47316-16
3,5 mm

Antrumstanzen
Antrum Punches
Pinzas para antro

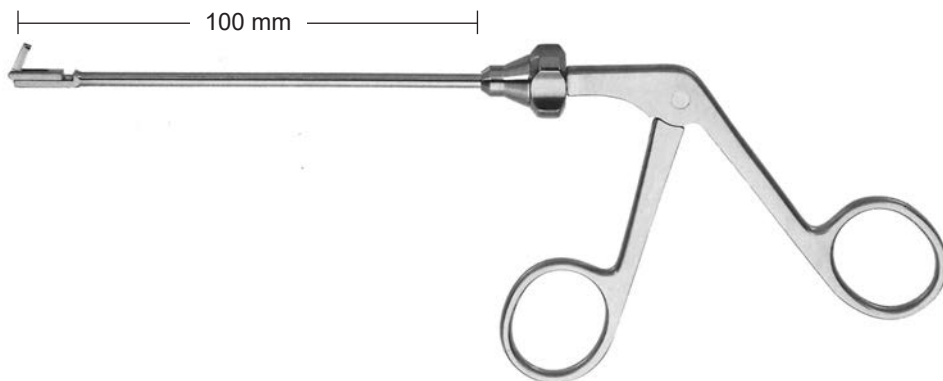

Retro Stanzen
Retro Punches
Pinza retrograda



Ø 4,5 mm

starr, Schnitt 2,5 x 6,5 mm
rigid, cut 2.5 x 6.5 mm
rigida, corte 2,5 x 6,5 mm

- 47310-00 rechts schneidend / right cutting / corte hacia la derecha
- 47311-00 links schneidend / left cutting / corte hacia la izquierda
- 47312-00 nach oben schneidend / upward cutting / corte hacia arriba
- 47313-00 nach unten schneidend / downward cutting / corte hacia abajo



Ø 3,0 mm

starr, Schnitt 2,0 x 5,0 mm
rigid, cut 2.0 x 5.0 mm
rigida, corte 2,0 x 5,0 mm

- 47316-00 rechts schneidend / right cutting / corte hacia la derecha
- 47317-00 links schneidend / left cutting / corte hacia la izquierda
- 47315-00 nach oben schneidend / upward cutting / corte hacia arriba
- 47314-00 nach unten schneidend / downward cutting / corte hacia abajo



Ø 3,0 mm

Schnitt 2,0 x 5,0 mm
Cut 2.0 x 5.0 mm
corte 2,0 x 5,0 mm

- 47318-00 360° drehbar / rotatable / giratoria

Antrumstanzen
Antrum Punches
Pinzas para antro

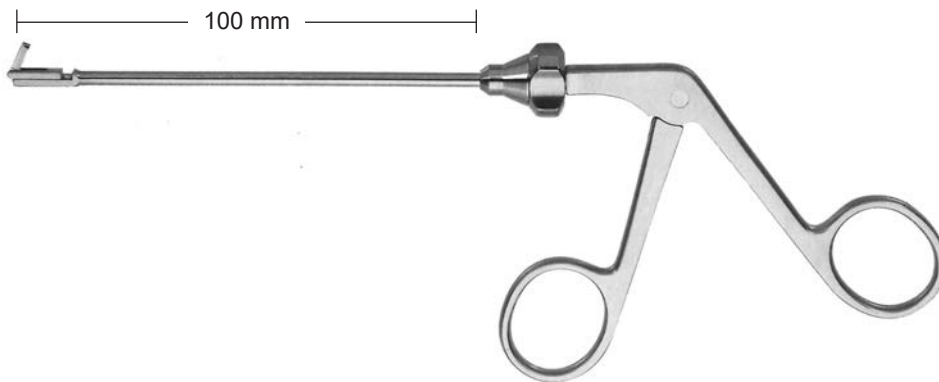

Retro Stanzen, für Kinder
Retro punches, for children
Pinza retrograda, para niños



starr, Schnitt 1,5 x 3,5 mm
rigid, cut 1.5 x 3.5 mm
rígida, corte 1,5 x 3,5 mm

- 47321-00 rechts schneidend / right cutting / corte hacia la derecha
- 47322-00 links schneidend / left cutting / corte hacia la izquierda
- 47323-00 nach oben schneidend / upward cutting / corte hacia arriba
- 47324-00 nach unten schneidend / downward cutting / corte hacia abajo



Schnitt 1,5 x 3,5 mm
Cut 1.5 x 3.5 mm
corte 1,5 x 3,5 mm

- 47325-00 360° drehbar / rotatable / giratoria

Zirkular Stanze
Circular Punch
Pinza circular

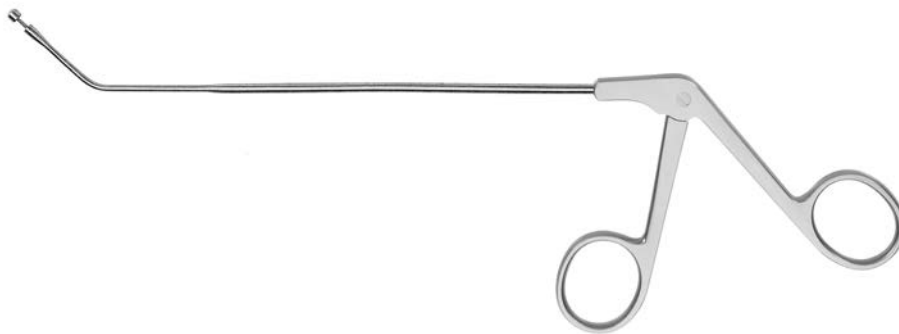

360° schneidend / cutting / cortante

gerader Schaft
shaft straight
vástago recto

45° nach oben gebogen
45° curved upward
curvada hacia arriba en 45°

Ø 3,5 mm 47319-35
Ø 4,5 mm 47319-45

47320-35
47320-45

Nasenscheren
Nasal Scissors
Tijeras nasales

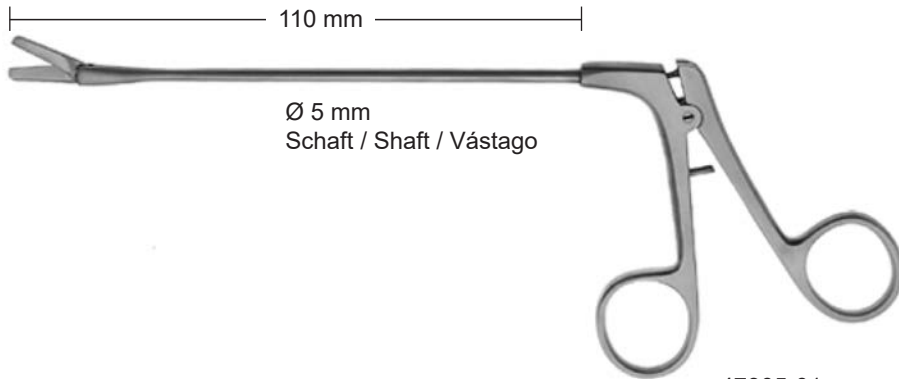

110 mm

Ø 5 mm
Schaft / Shaft / Vástago

47305-01
gerade
straight
recta



47305-02
rechts gebogen
right curved
curvada hacia la derecha



47305-03
links gebogen
left curved
curvada hacia la izquierda

Präparierscheren
Dissecting Scissors
Tijeras de disección



METZENBAUM



09280-12	12 cm, 4 3/4"	09281-12
09284-12 TC	12 cm, 4 3/4"	09285-12 TC
09966-11 SC	12 cm, 4 3/4"	09967-11 SC
09280-15	15 cm, 6"	09281-15
09284-15 TC	15 cm, 6"	09285-15 TC
09970-14 SC	15 cm, 6"	09971-14 SC
09280-18	18 cm, 7"	09281-18
09284-18 TC	18 cm, 7"	09285-18 TC
09970-18 SC	18 cm, 7"	09971-18 SC

Präparierscheren
Dissecting Scissors
Tijeras de disección



METZENBAUM



09270-15
09270-18

15 cm, 6"
18 cm, 7"



09271-15
09271-18

09274-15 TC
09274-18 TC

15 cm, 6"
18 cm, 7"

09275-15 TC
09275-18 TC



METZENBAUM-FINO



09282-15
09286-15 TC

15 cm, 6"
15 cm, 6"



09283-15
09287-15 TC

09282-18
09286-18 TC

18 cm, 7"
18 cm, 7"

09283-18
09287-18 TC

Präparierscheren
Dissecting Scissors
Tijeras de disección



SANVENERO



09302-14

14 cm, 5 1/2"



09303-14



JOSEPH



09304-14

14 cm, 5 1/2"



09305-14

Präparierscheren
Dissecting Scissors
Tijeras de disección



- | | |
|--------------------|----------------------|
| 09310-12 | 12 cm, 4 3/4" |
| 09314-12 TC | 12 cm, 4 3/4" |
| 09995-12 SC | 12 cm, 4 3/4" |
| 09310-15 | 15 cm, 6" |

KILNER (RAGNELL)



- | | |
|--------------------|-----------|
| REYNOLDS (JAMESON) | |
| 09321-15 | 15 cm, 6" |
| 09993-15 SC | 15 cm, 6" |
| 09321-18 | 18 cm, 7" |

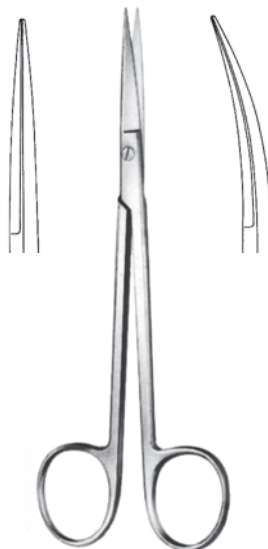

- | | |
|--------------------|----------------------|
| KELLY | |
| 09540-16 | 16 cm, 6 1/4" |
| 09542-16 TC | 16 cm, 6 1/4" |
| 09541-16 | 16 cm, 6 1/4" |
| 09543-16 TC | 16 cm, 6 1/4" |
| 09544-16 SC | 16 cm, 6 1/4" |
| 09545-16 SC | 16 cm, 6 1/4" |

Feine Scheren
Delicate Scissors
Tijeras finas

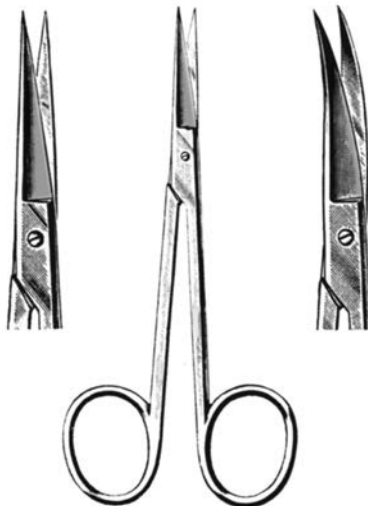

IRIS

09340-09	9 cm, 3 1/2"	09341-09
09340-10	10 cm, 4"	09341-10
09340-11	11 cm, 4 3/8"	09341-11
09344-11 TC	11 cm, 4 3/8"	09345-11 TC
09980-11 SC	11 cm, 4 3/8"	09981-11 SC



BONN

09342-08 8 cm, 3 1/8" 09343-08

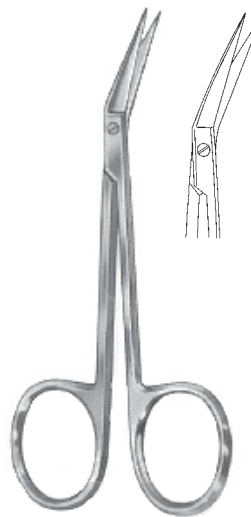

IRIS

09346-11
11 cm, 4 3/8"

Feine Scheren
Delicate Scissors
Tijeras finas



KNAPP
10 cm, 4"



09348-01



09348-02



09348-03



09348-04



09348-05



09348-06

Feine Scheren
Delicate Scissors
Tijeras finas



LITTLER
09349-12
12 cm, 4 3/4"



GRAEFE
09350-10
10 cm, 4"

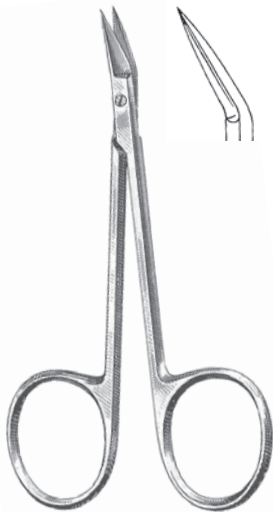

CONVERSE/WILMER/WALTER
09352-10
10 cm, 4"



COTTLE
09358-11
11 cm, 4 3/8"

Feine Scheren
Delicate Scissors
Tijeras finas



GRADLE
09350-09 9,5 cm, 3 3/4" 09351-09



09352-09 9,5 cm, 3 3/4" 09353-09



09354-10 10 cm, 4" 09355-10



09356-10 10 cm, 4" 09357-10

Feine Scheren
Delicate Scissors
Tijeras finas



STEVENS
11 cm, 4 3/8"

spitz
sharp
aguda



09360-11
09984-11SC



09361-11
09985-11 SC

stumpf
blunt
roma



09362-11



09363-11



STRABISMUS
09370-11 11 cm, 4 3/8" 09371-11
09374-11TC 11 cm, 4 3/8" 09375-11TC

Feine Scheren
Delicate Scissors
Tijeras finas



WAGNER
12 cm, 4 3/4"



09828-12



09826-12



09824-12
09982-12SC



WAGNER
12 cm, 4 3/4"



09823-12

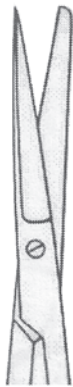

09829-12



09825-12
09983-12 SC

Nasenscheren
Nasal Scissors
Tijeras nasales



HEYMAN
09401-18 18 cm, 7"



FOMON
09403-15 15 cm, 6"



COTTLE
09405-16 16 cm, 6 ¼"
09405-16TC 16 cm, 6 ¼"



COTTLE-MASING
09406-10 10 cm, 4" 09407-10



FOMON
09617-13 13 cm, 5 ⅛"

Fadenscheren
Stitch Scissors
Tijeras para hilos



SPENCER
09802-09 9 cm, 3 1/2"
09802-11 11 cm, 4 3/8"



LITTAUER
09804-14
14 cm, 5 1/2"



O'BRIEN
09805-09
9 cm, 3 1/2"

Face Lift Scheren
 Face Lift Scissors
 Face Lift tijeras

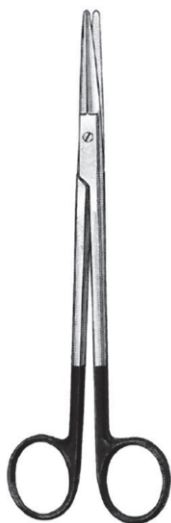

GORNEY
 19 cm, 7 1/2"

10010-19
10012-19 TC
 10014-19 SC

10011-19
10013-19 TC
 10015-19 SC



GORNEY-FREEMAN

10061-19 19 cm, 7 1/2"
10061-19 TC 19 cm, 7 1/2"
 10061-19 SC 19 cm, 7 1/2"

10061-23 23 cm, 9"
10061-23 TC 23 cm, 9"
 10061-23 SC 23 cm, 9"

Face Lift Scheren
 Face Lift Scissors
 Face Lift tijeras



KAYE

10028-14 TC	14 cm, 5 1/2"	10029-14 TC
10034-14 SC	14 cm, 5 1/2"	10035-14 SC
10030-18 TC	18 cm, 7"	10031-18 TC
10036-18 SC	18 cm, 7"	10037-18 SC
10032-23 TC	23 cm, 9"	10033-23 TC
10038-23 SC	23 cm, 9"	10039-23 SC



PECK-JOSEPH

10044-14	14,5 cm, 5 3/4"	10045-14
10048-14 SC	14,5 cm, 5 3/4"	10049-14 SC



BEUSE

10050-14	14 cm, 5 1/2"	10051-14
10050-18	18 cm, 7"	10051-18

Blepharoplastik Scheren
Blepharoplasty Scissors
Tijeras para blefaroplastia



GREENBERG-PAR

10201-11	11,5 cm, 4 ½"
10201-11SC	11,5 cm, 4 ½"



KAYE

10206-11	11,5 cm, 4 ½"	10207-11
10206-11SC	11,5 cm, 4 ½"	10207-11SC

Mikro Scheren
Micro Scissors
Micro tijeras

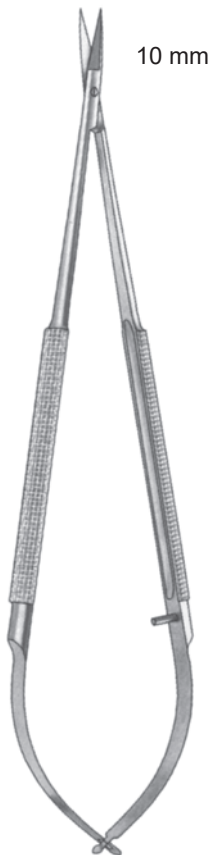

	—————	—————
		—————
11 cm, 4 3/8"	10202-11	10203-11
14,5 cm, 5 3/4"	10202-14 10202-14T	10203-14 10203-14T
18 cm, 7"	10202-18 10202-18T	10203-18 10203-18T

T= Titan, titanium, titanio

Mikro Scheren
Micro Scissors
Micro tijeras

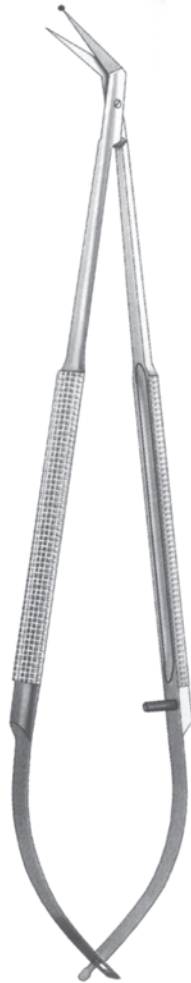

18 cm, 7"



25°

10220-25

10220-25T



45°

10220-45

10220-45T

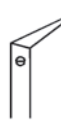

60°

10220-60

10220-60T



90°

10220-90

10220-90T



125°





10220-00

10220-00T

T= Titan, titanium, titanio

Mikro Scheren
Micro Scissors
Micro tijeras

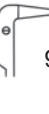

	11 cm 4 3/8"	14,5 cm 5 3/4"	18 cm 7"
 25°	10226-11	10226-14	10226-18 10226-18T
 45°	10227-11	10227-14	10227-18 10227-18T
 60°	10228-11	10228-14	10228-18 10228-18T
 90°	10229-11	10229-14	10229-18 10229-18T
 125°	10230-11	10230-14	10230-18 10230-18T

T= Titan, titanium, titanio

Nasenschere
Nasal Scissor
Tijera nasal



CAPLAN
47256-20
20 cm, 8"

Tumorschere
Tumor Scissors
Tijera para tumores

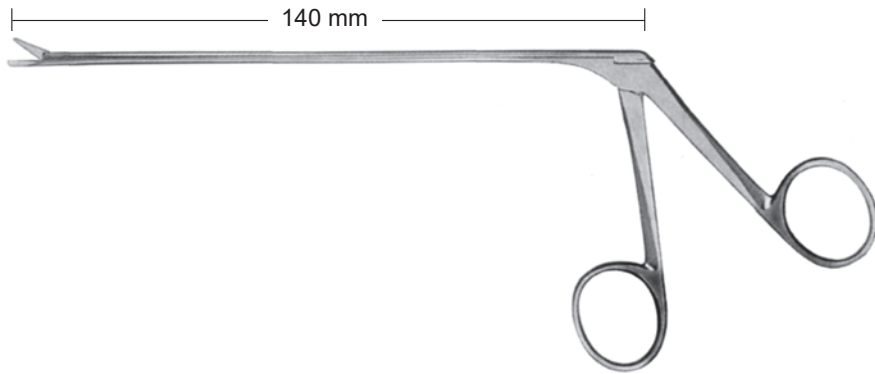

93755-14

gerade
straight
recta



93756-14

rechts gebogen
curved right
curvada hacia la derecha



93757-14

links gebogen
curved left
curvada hacia la izquierda

Knochensplitterzangen
Bone Cutting Forceps
Pinzas cortantes para huesos



COTTLE-KAZANJIAN
33282-19
19 cm, 7 ½"



MC INDOE
33283-17
17 cm, 6 ¾"

Nadelhalter
Needle Holders
Porta-agujas



DERF
25110-12 12 cm, 4 3/4" 25114-12 TC



WEBSTER
25128-13 13 cm, 5 1/8"
25129-13 TC 13 cm, 5 1/8"

BABY-WEBSTER
25136-11 11 cm, 4 3/8"
25137-11 TC 11 cm, 4 3/8"



HALSEY
25130-13 13 cm, 5 1/8" 25140-13
25134-13 TC 13 cm, 5 1/8" 25144-13 TC



CRILE-WOOD
25160-15 15 cm, 6" 25164-15 TC

Saug- und Spülinstrumente
Suction and Irrigation Instruments
Instrumentos de aspiración y irrigación

Luer-Lock

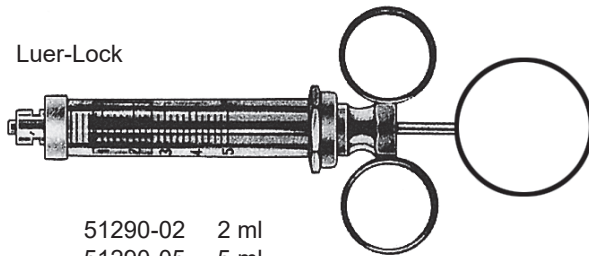

- 51290-02 2 ml
- 51290-05 5 ml
- 51290-10 10 ml
- 51290-20 20 ml



51291-00
2,5 mm Ø

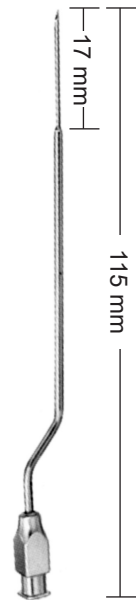

51293-00
0,8 mm Ø



51292-00



51293-45
45°



51293-90
90°

Saugrohre
Suction Tubes
Tubos de aspiración

Koagulations-Saugrohr, gerade
Coagulation Suction Tube, straight
Tubo de succion y coagulación, recto

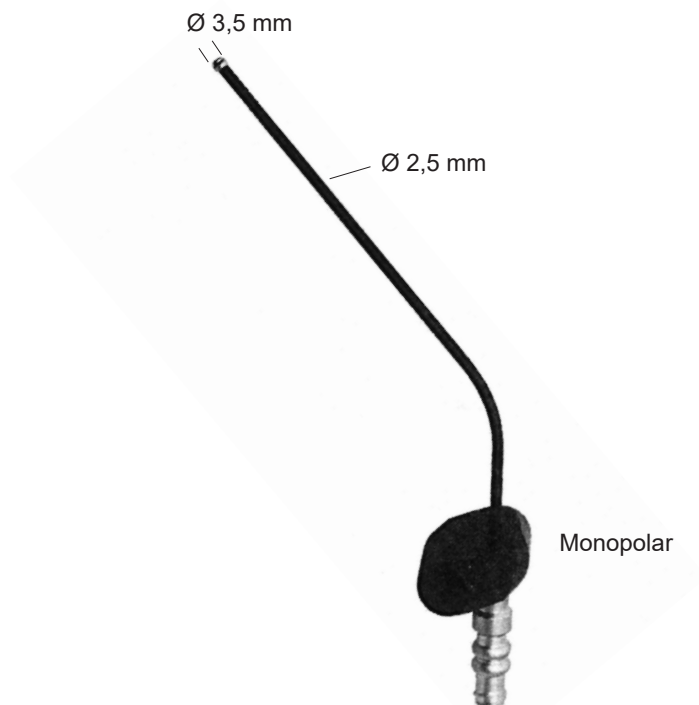

41312-10
Nutzlänge 10 cm, 4"
Working length 10 cm, 4"
Largo útil 10 cm, 4"

41312-26
Nutzlänge 26 cm, 10 1/4"
Working length 26 cm, 10 1/4"
Largo útil 26 cm, 10 1/4"

Kabelanschluß männlich
Cable connector male
Conexion del cable macho

Spülkanülen
Irrigating Tubes
Canulas irrigadoras



EICKEN (KILLIAN)
14,5 cm, 5 $\frac{3}{4}$ "
Ø

47331-20	2,0 mm	47332-20
47331-25	2,5 mm	47332-25
47331-30	3,0 mm	47332-30
47331-40	4,0 mm	47332-40

KILLIAN
Ø 1,5 mm
47345-15

Saugkanülen
Suction Tubes
Cánulas aspiradoras

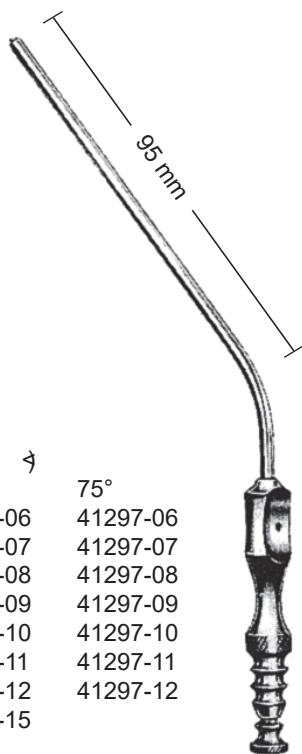

Charr.		↔
F.G.	30°	75°
6	41295-06	41297-06
7	41295-07	41297-07
8	41295-08	41297-08
9	41295-09	41297-09
10	41295-10	41297-10
11	41295-11	41297-11
12	41295-12	41297-12
15	41295-15	

FRAZIER/FERGUSSON
19 cm, 7 ½"



FERGUSSON
41294-40
18 cm, 7"
ø 4 mm, 90°

Saugrohre
Suction Tubes
Tubos de aspiración

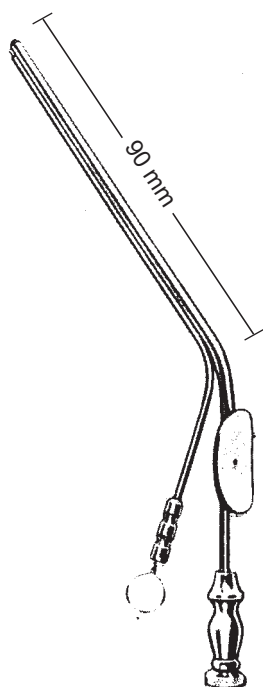

HOUSE
9 cm, 3 1/2"

41303-09	Ø 0,9 x 0,7 mm
41303-12	Ø 1,2 x 0,9 mm
41303-15	Ø 1,5 x 1,2 mm
41303-18	Ø 1,8 x 1,8 mm
41303-25	Ø 2,5 x 2,0 mm
41303-30	Ø 3,0 x 2,0 mm
41303-45	Ø 4,5 x 2,0 mm

Trokare
Trocars
Trócares

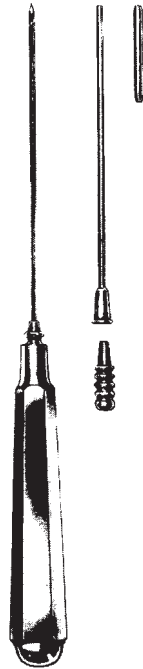

LICHTWITZ
23128-19 1,75 mm Ø

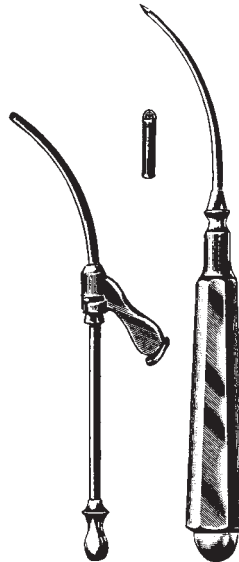

COAKLEY
23140-02 2,25 mm Ø

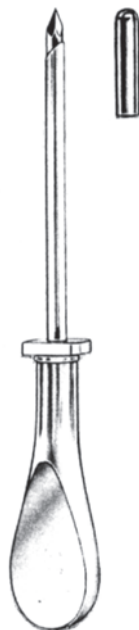

SINOSKOPIE TROKAR
Universal
8,5 cm, 3.4"

23181-40 für Optik mit Ø 4,0 mm
for optics Ø 4,0 mm
para la óptica de Ø 4,0 mm

Nasenmesser
Nasal Knives
Bisturías nasales



JOSEPH
16 cm, 6 ¼"



47370-16 47371-16
stumpf, blunt,
romos



47372-16 47373-16
spitz, pointed,
agudos



FREER
47374-16
16,5 cm, 6 ½"



JOSEPH
47375-16
16,5 cm, 6 ½"



FREER
47375-19
19 cm, 7 ½"

Nasenplastik- und Operationsmesser, Sichelmesser
 Rhinoplastic and Nasal Knives, Septum Sickle Knives
 Bisturías para plástica y operaciones de la nariz, Bisturías para el tabique nasal

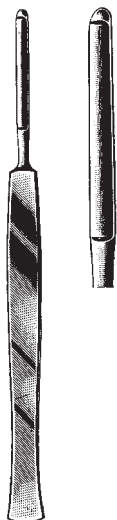

JOSEPH
 47376-16
 16 cm, 6 ¼"

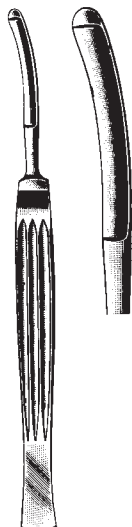

CONVERSE
 47379-16
 16 cm, 6 ¼"



COTTLE
 47380-15
 15 cm, 6"



COTTLE
 47382-15
 15 cm, 6"



JOSEPH
 47384-15
 15 cm, 6"



JOSEPH
 47385-15
 15 cm, 6"



REDA
 19 cm, 7 ½"



47386-01
 spitz
 pointed
 agudo



47386-02
 stumpf
 blunt
 romo

Schwingmesser
Septum Swivel Knives
Bisturías para el tabique nasal



BALLENGER
20 cm, 8"

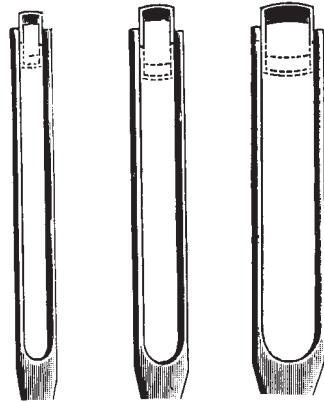

47390-03 3 mm 47390-04 4 mm 47390-05 5 mm

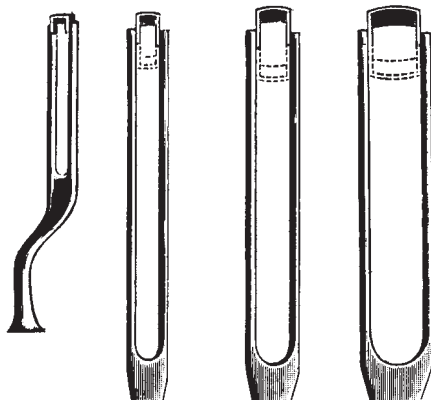

47392-03 3 mm 47392-04 4 mm 47392-05 5 mm

Submukosamesser, Knorpelritzmesser
Submucosa Knife, Cartilage Knife
Cuchillo para submucosa, Cuchillo para rajar cartílagos



FREER-INGALS
47372-17
17 cm, 6 $\frac{3}{4}$ "



MASING
47377-13
13 cm, 5 $\frac{1}{8}$ "

Dermatome
Dermatome
Dermátomos



SCHINK
07490-00
30 cm, 11 $\frac{3}{4}$ "

compl.
mit/with/con
07490-01 (1) Stk./pcs
07490-02 (2) Stk./pcs



07490-01

Ersatzklinge
Spare blade
Hoja de repuesto

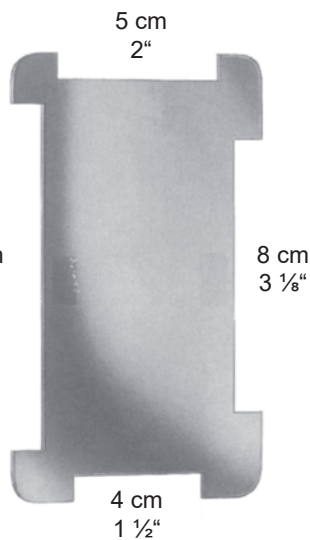

07490-02

Spannplatte
Skin straightening plate
Placa para extender la piel

Dermatome
Dermatome
Dermátomos



HUMBY
07495-31
31 cm, 12 1/4"



SILVER
07498-00
19 cm, 7 1/2"



WATSON
07499-00
30 cm, 11 3/4"

Ersatzklingen, unsteril / Spare blade, non sterile
Hoja de repuesto, no esteril

07496-31

07296-00

07499-01

Septum Elevatoren
Septum Elevators
Elevadores para el tabique



McKENTY
15 cm, 6"



47410-04
4 mm



47410-05
5 mm



HALLE
47410-16
16,5 cm, 6 1/2"



JOSEPH
47411-16
16 cm, 6 1/4"

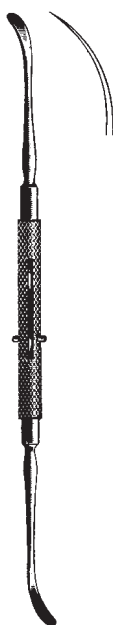

ROGER
47413-19
19 cm, 7 1/2"



5 mm



5 mm



MASING
47414-21
21 cm, 8"

Septum Elevatoren
Septum Elevators
Elevadores para el tabique



FREER
47415-18
18 cm, 7"

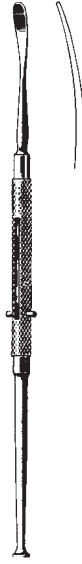

FREER
47417-19
19 cm, 7 1/2"

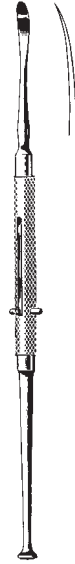

FREER
47419-19
19 cm, 7 1/2"



KILLIAN
47420-01
18,5 cm, 7 1/4"



PIERCE
47420-02
21 cm, 8 1/4"



SINUS
47420-03
18 cm, 7"

Septum Elevatoren
Septum Elevators
Elevadores para el tabique



PENNINGTON
47420-04
21 cm, 8 1/4"



McKENTY
47420-20
22 cm, 8 3/4"



HOWARTH
47421-21
21,5 cm, 8 1/2"



COTTLE
47421-23
23 cm, 9"



COTTLE JOSEPH
47422-22
22 cm, 8 3/4"



COTTLE
47423-22
22 cm, 8 3/4"

Septum Elevatoren
Septum Elevators
Elevadores para el tabique



COTTLE
47424-16
16 cm, 6 ¼"



COTTLE
47425-19
19 cm, 7 ½"

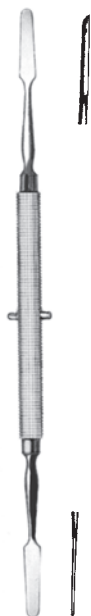

KILLIAN
47426-22
22 cm, 8 ¾"



HAJEK-BALLENGER
47428-21
22 cm, 8 ¾"



BALLENGER
47430-22
22 cm, 8 ¾"

Elevatoren
Elevators
Elevadores

Nasenfraktur-Elevator
Nasal fracture elevator
Elevador para fracturas nasales

Septumfraktur-Elevator
Septum fracture elevator
Elevador para fracturas del tabique nasal

9 mm



BOIES
33720-19
19 cm, 7 1/2"

6 mm



Antrum-Elevator
Antrum Elevator
Elevador para el antro

SEWALL
47412-20
20 cm, 8"



GOLDMANN
33720-20
20 cm, 8"

Raspatorien
Raspatories
Periostótomos

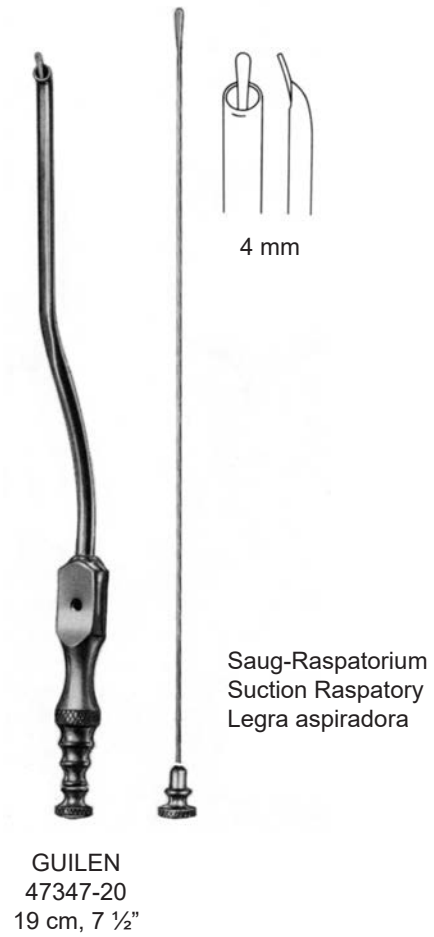
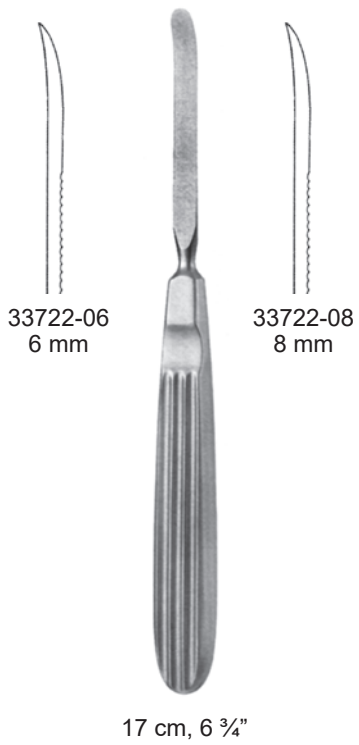

Osteotom mit Ferrozellgriff
Osteotome with Ferrozell-Handle
Osteótomo con mango de Ferrozell

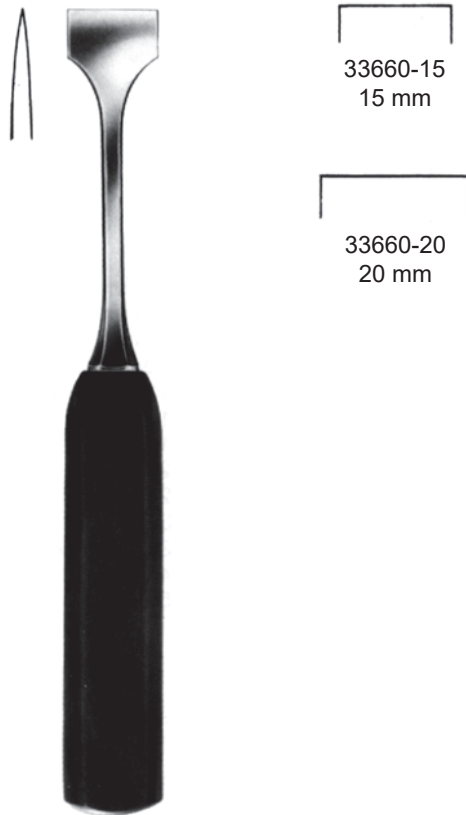

LEXER
22 cm, 8 3/4"

Osteotome
Osteotomes
Osteotomo

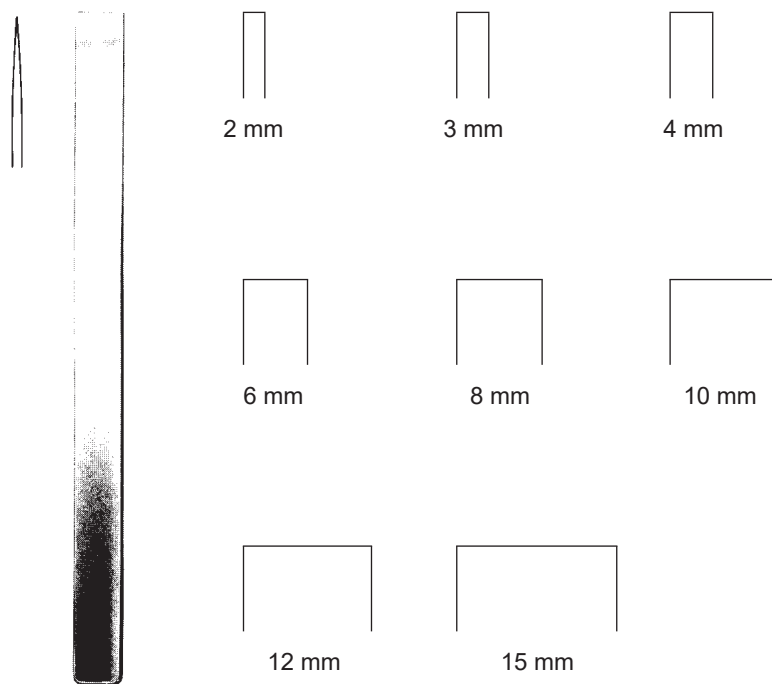

MINI-LAMBOTTE

12,5 cm, 5"	mm	17 cm, 6 ¾"
33654-02	2	33652-02
33654-03	3	33652-03
33654-04	4	33652-04
33654-06	6	33652-06
33654-08	8	33652-08
33654-10	10	33652-10
33654-12	12	33652-12
33654-15	15	33652-15

Septum Meißel
Rhinoplastic Chisels
Cinceles para la plàstica nasal

4 mm



FREER
47450-04
15 cm, 6"

4 mm



FREER
47451-04
15 cm, 6"

Septum Meißel
Rhinoplastic Chisels
Cinceles para la plàstica nasal



COTTLE
18 cm, 7"



47454-04
4 mm



47454-07
7 mm



47454-09
9 mm



47454-12
12 mm



COTTLE
47455-06
18 cm, 7"



6 mm



COTTLE
18 cm, 7"



47458-04
4 mm



47458-07
7 mm



47458-09
9 mm



47458-12
12 mm



COTTLE
18 cm, 7"



47460-04
4 mm



47460-07
7 mm



47460-12
12 mm

Septum Meißel
Rhinoplastic Chisels
Cinceles para la plàstica nasal



FOMON
17 cm, 6 3/4"

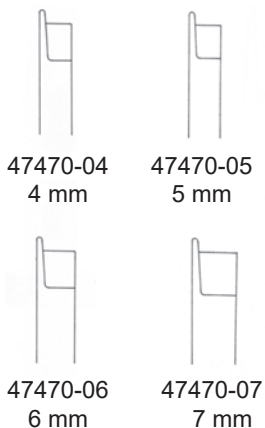

CINELLI
16 cm, 6 1/4"

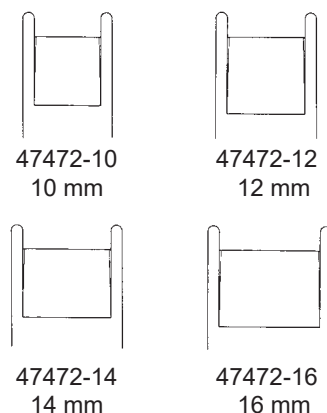

SHEEHAN
16 cm, 6 1/4"

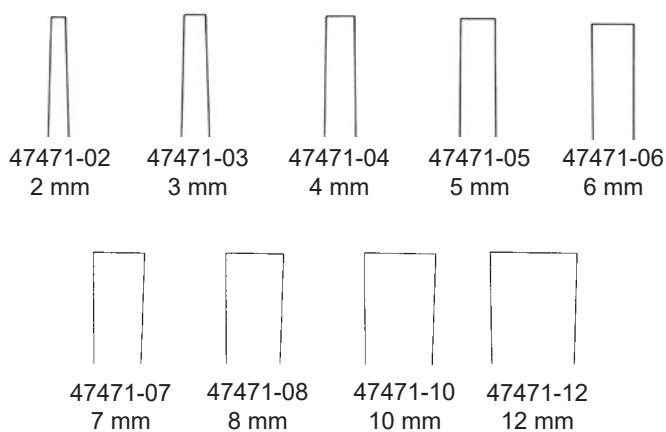

Septum Meißel, Osteotom
 Rhinoplastic Chisels, Osteotomes
 Cinceles para la plàstica nasal, Osteótomos

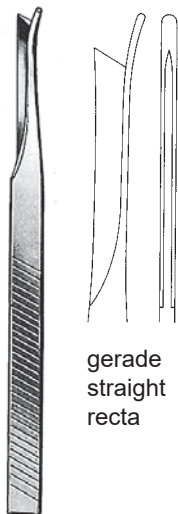

gerade
 straight
 recta

SILVER
 47473-01
 18 cm, 7"

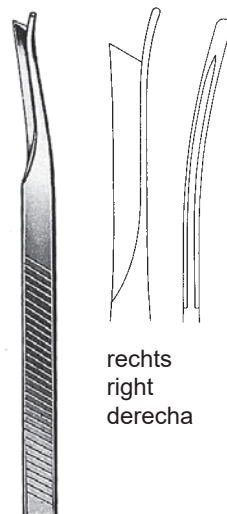

rechts
 right
 derecha

SILVER
 47473-02
 18 cm, 7"

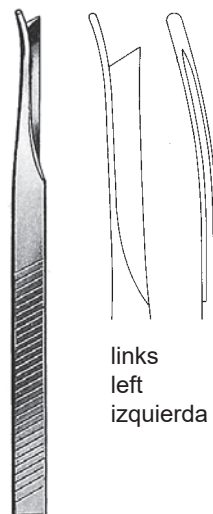

links
 left
 izquierda

SILVER
 47473-03
 18 cm, 7"

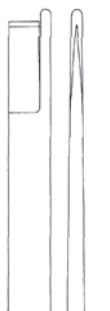

47474-03

gerade
 straight
 recta

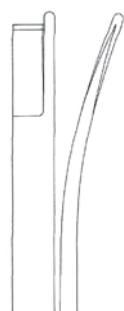

47474-01

rechts
 right
 derecha



47474-02

links
 left
 izquierda

NEIVERT-ANDERSON
 20,5 cm, 8" 7 mm

Osteotome
Osteotomes
Osteotomos

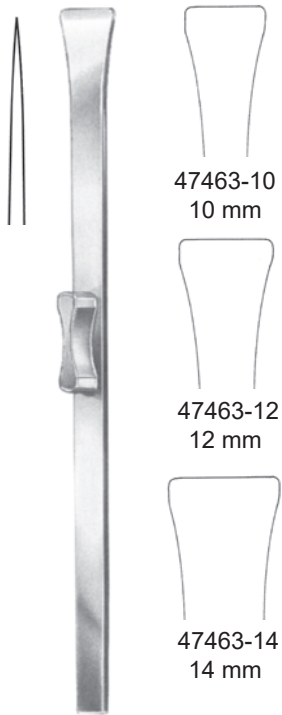

RUBIN
18,5 cm, 7 ¼"



47475-04 4 mm
47475-06 6 mm
47475-08 8 mm

OBWEGESER
18,5 cm, 7 ¼"

Meißel
Chisels
Cinceles

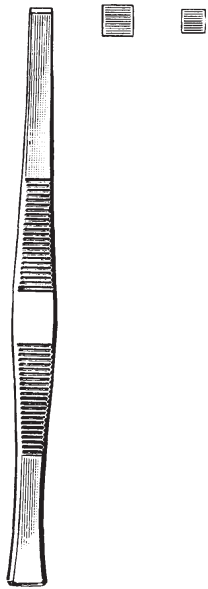

PASSOW
12 cm, 4 3/4"
33626-35 3,5 mm
33626-25 2,5 mm

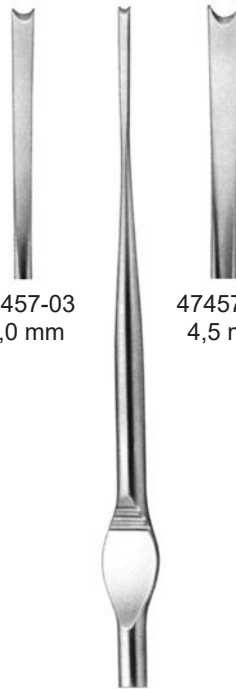

47457-03
3,0 mm

47457-05
4,5 mm

WALTER
18 cm, 7"

Septum Meißel
Rhinoplastic Chisels
Cinceles para la plàstica nasal



KILLIAN-CLAUS
47482-05
17 cm, 6 3/4"



HAJEK
16 cm, 6 1/4"

- 47484-04 4 mm
- 47484-06 6 mm
- 47484-08 8 mm



WEST
47486-16
16 cm, 6 1/4"



WEST
47487-16
16 cm, 6 1/4"



FREER
47489-16
16 cm, 6 1/4"

Knorpelquetscher
Cartilage Crusher
Machacadora de cartilago



COTTLE
47461-00 7,5 cm, 3"

Nasenraspeln
Nasal Rasps
Escofinas nasales



JOSEPH
47502-16 16 cm, 6 1/4"



MALTZ
47504-18 18 cm, 7"



47507-17



WIENER
18 cm, 7"



47507-18



diamantiert
with diamond coating
con boca de diamante

PEET
47523-01 19 cm 7 1/2" 47523-02



GLABELLA
47524-01 21 cm, 8 1/4"



47525-20
fein, 20 Zähne
fine, 20 teeth
fina, 20 dientes

47526-20
grob, 11 Zähne
coarse, 11 teeth
gruesa, 11 dientes

PARKES
21 cm, 8 1/4"

Nasenraspeln
Nasal Rasps
Escofinas nasales

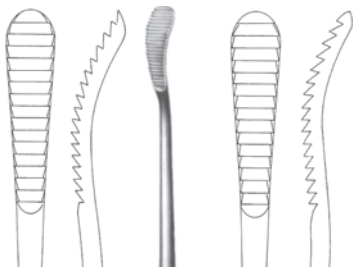

AUFRICHT
47511-21 21 cm, 8 1/4" 47513-21



JOSEPH (LEWIS)
47514-16 18 cm, 7" 47516-16

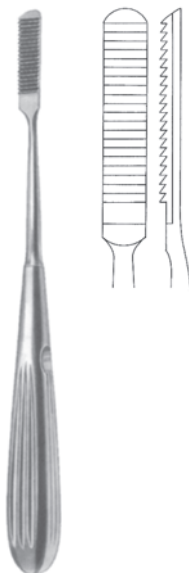

MALTZ (COTTLE)
47518-21 21 cm, 8 1/4"

Nasenraspel
Nasal Rasp
Escofina nasal

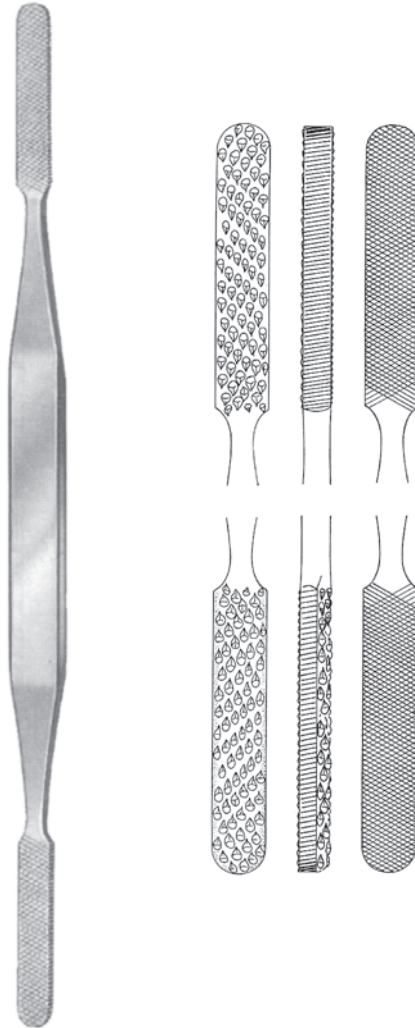

FOMON
47520-21
21 cm, 8 1/4"

Nasenraspeln
Nasal Rasps
Escofinas nasales

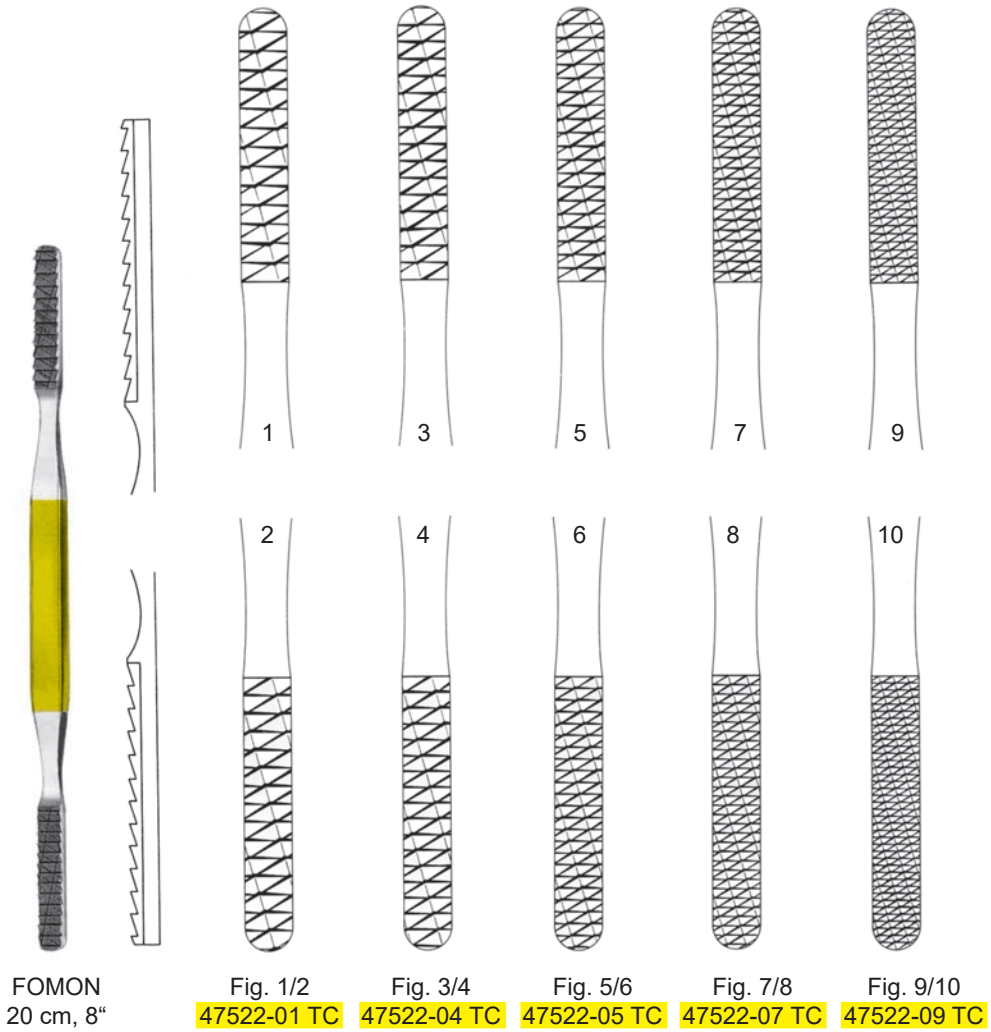

Nasenraspeln
Nasal Rasps
Escofinas nasales



MASING
47528-01
21 cm, 8 ¼"



MASING
47528-02
21 cm, 8 ¼"

Nasenraspeln
Nasal Rasps
Escofinas nasales



Fig. 1
47526-16

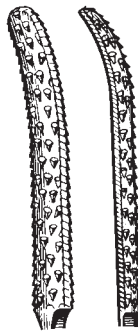

Fig. 2
47527-16

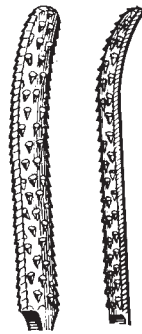
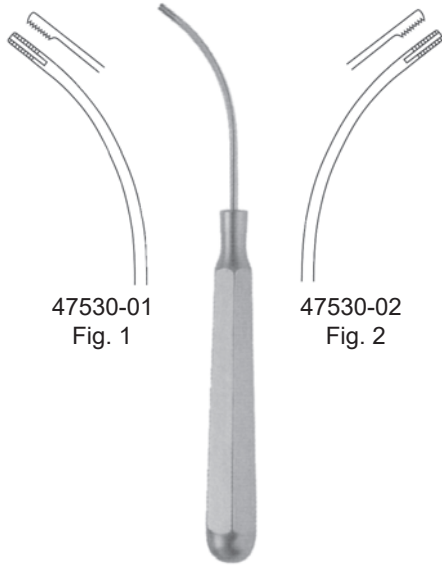

Fig. 3
47529-16



GALLAHER
16 cm, 6 1/4"

Nasenraspeln, Nasensägen
 Nasal Rasps, Nasal Saws
 Escofinas nasales, Sierras nasales



47530-01
 Fig. 1

47530-02
 Fig. 2

DINGMAN Set
 47530-00
 15 cm, 6"



47533-19
 gerade
 straight
 recta



47532-19
 links
 left
 izquierda

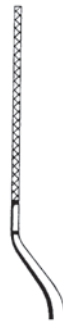

47534-19
 rechts
 right
 derecha

JOSEPH
 19 cm, 7 1/2"

Nasensägen
Nasal Saws
Sierras nasales



JOSEPH
47535-01 17 cm, 6 3/4" 47535-02



LINDEMANN
47535-20 20 cm, 8"

Feine Wundhäkchen
 Fine Retractors
 Ganchos finos

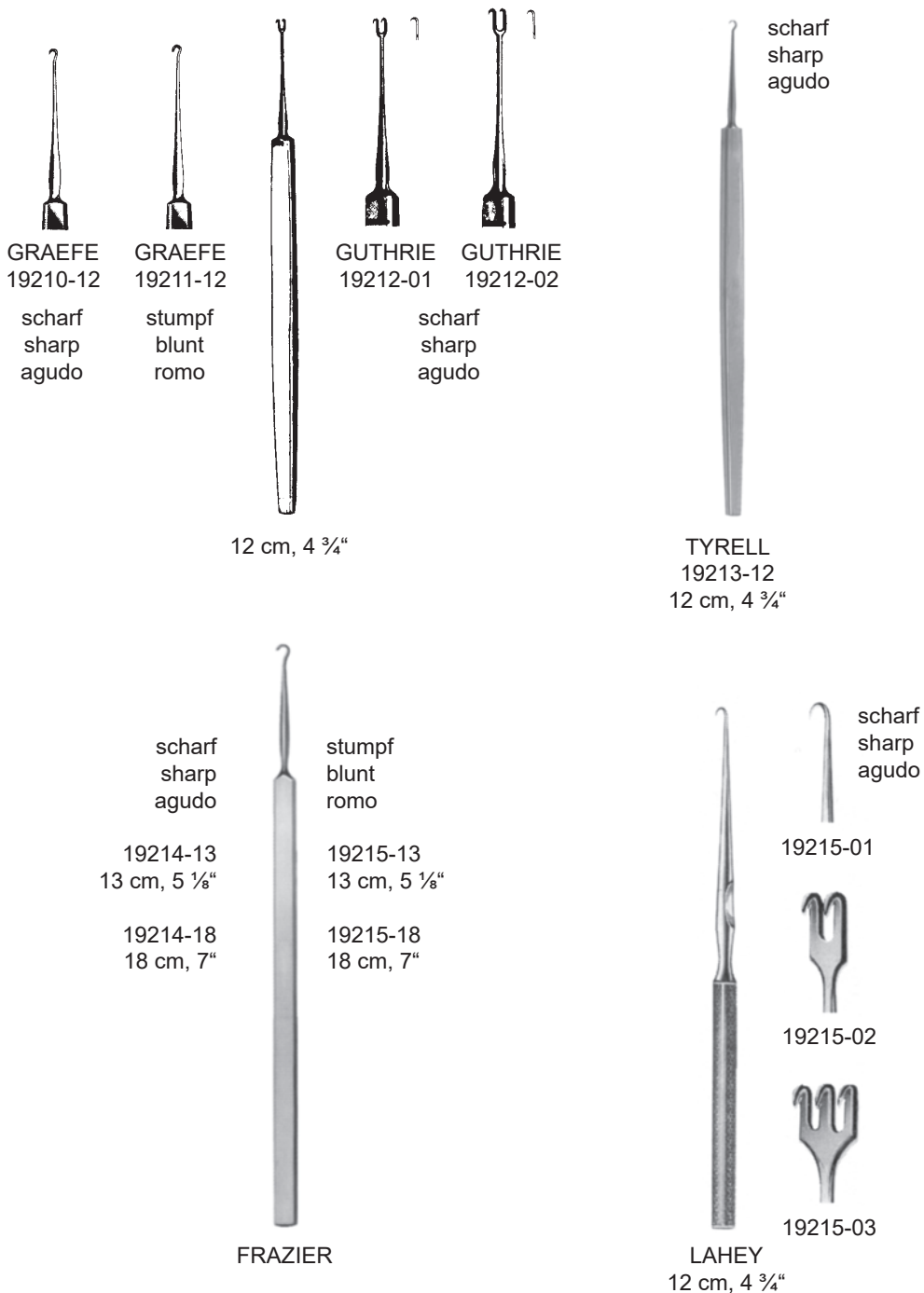

Feine Wundhäkchen
Fine Retractors
Ganchos finos



JOSEPH
16 cm, 6 1/4"



19216-01
1 mm



19216-02
2 mm



19216-05
5 mm



19216-07
7 mm



19216-10
10 mm



KLEINERT-KUTZ
13 cm, 5 1/8"



19217-03



19217-05



19217-07

Feine Wundhäkchen
Fine Retractors
Ganchos finos

3 mm



BARSKY
19218-01
15 cm, 6"

3 mm



BARSKY
19218-02
15 cm, 6"

3 mm



HUMBY
19218-11
11,5 cm, 4 1/2"

Feine Wundhäkchen
Fine Retractors
Ganchos finos

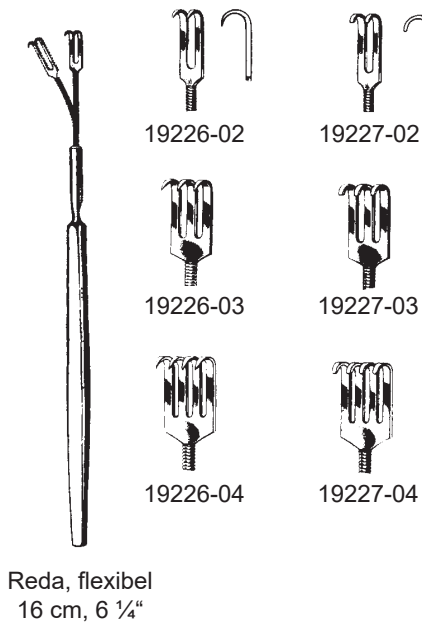
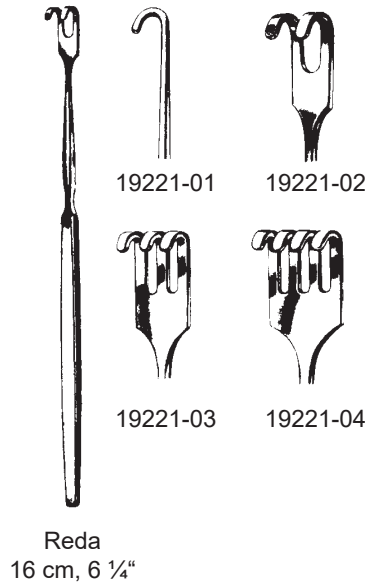
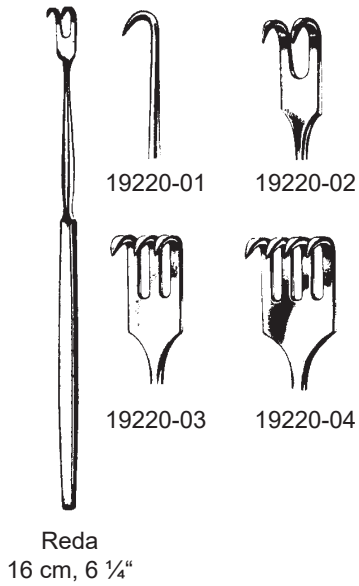

Feine Wundhäkchen
Fine Retractors
Ganchos finos



spitz
sharp
agudo

ROLLET
43376-13
13,5 cm, 5 ¼"



stumpf
blunt
romo

KNAPP
43377-13
13 cm, 5 ⅛"



LUCAE
14 cm, 5 ½"



45193-01
2 mm



45193-02
3 mm



45193-03
4 mm



BERGMANN
47569-14
14 cm, 5 ½"

Nasenhaken
Nasal Retractor
Retractores nasales



COTTLE
47540-16
16 cm, 6 1/4"



MASING
47541-14
14 cm, 5 1/2"



AUFRICHT
47542-12
12 cm, 4 3/4"



AUFRICHT
47551-16
16 cm, 6 1/4"



AUFRICHT
47551-16CL
16 cm, 6 1/4"



MASING-NEIVERT
47552-16
20 cm, 8"

Nasenflügelhäkchen
Alar Retractor
Gancho para las alas de la nariz

10 x 12 mm



COTTLE
47553-15
15 cm, 6"

10 mm



COTTLE-NEIVERT
47559-20
20 cm, 8"

10 mm



CONVERSE
47566-12
12 cm, 4 3/4"

14 mm

Nasenflügelhäkchen
Alar Retractor
Gancho para las alas de la nariz

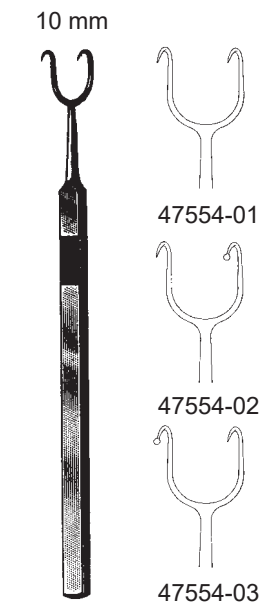

COTTLE
14,5 cm, 5 3/4"

3 x 11 mm



KILNER
47555-08
8 cm, 3 1/8"

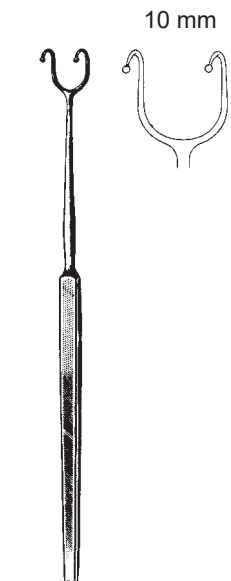

FOMON
47556-16
16 cm, 6 1/4"



FOMON
47557-17
17 cm, 6 3/4"

Feine Wundhäkchen
Fine Retractors
Ganchos finos



FREER
47558-15
15 cm, 6"



GILLIES
18 cm, 7"



Fig. 1
47560-18



Fig. 2
47562-18



COTTLE
47564-16
16 cm, 6 1/4"

Choanahaken, Fingerringhäkchen
Choana Hook, Retractor with Finger Ring
Gancho para coanas, Ganchito con anillo



LANGE
47563-22
23 cm, 9"

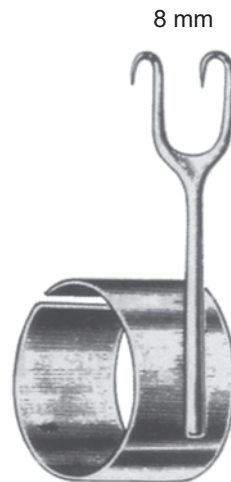

8 mm
COTTLE
47568-08

Antrumküretten
Antrum Curettes
Curetas para el antro

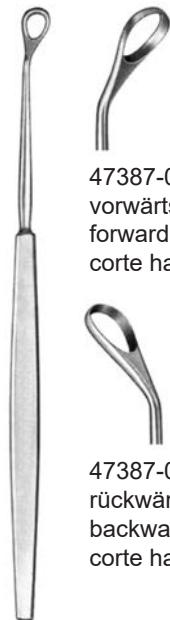

47387-01
vorwärts schneidend
forward cutting
corte hacia adelante



47387-02
rückwärts schneidend
backward cutting
corte hacia atras

ANTRUM
19 cm, 7 1/2"

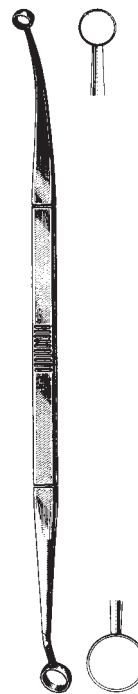

FAULKNER
47601-21
21 cm, 8 1/4"



47607-01
Fig. 1



47607-02
Fig. 2



47607-03
Fig. 3



47607-04
Fig. 4



47607-05
Fig. 5



47607-06
Fig. 6

COAKLEY
17 cm, 6 3/4"

Antrum Kürette, Antrumlöffel
Antrum Curettes
Cucharillas para antro



20 cm, 8"

Oval



47388-01
7 mm

47388-02
8 mm

47388-03
9 mm

Oval
30°



47388-04
2,5 mm

45°



47388-05
Ø 5 mm



19 cm, 7 1/2"



47399-01
55°



47399-02
90°

Scharfe Löffel
 Bone Currettes
 Cucharillas cortantes



33476-01
 4,8 mm

33476-02
 5,8 mm

33476-03
 6,8 mm

biegsam
 malleable
 maleable

HALLE
 21 cm, 8 1/4"

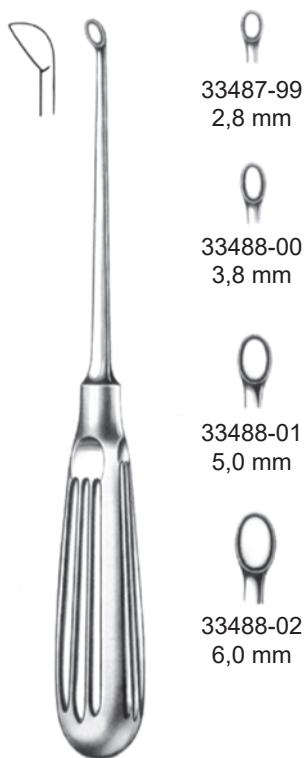

33487-99
 2,8 mm

33488-00
 3,8 mm

33488-01
 5,0 mm

33488-02
 6,0 mm

DAUBENSPECK
 20 cm, 8"

Hämmer
Bone Mallets
Martillos

Ø 25 mm



GERZOG
33686-25
18 cm, 7" 250g

Ø 25 mm



33694-01 18,5 cm, 7 1/4", 135 g
33694-03 Ersatzbacken
Nylon Caps
Tapas de repuesto

Ø 25 mm



33694-02 18,5 cm, 7 1/4"
1 Nylonbacke
1 Nylon Cap
1 tapa de nylon

Ø 20 mm



MEAD
33693-32
17 cm, 6 3/4" 320 g

Hämmer
Bone Mallets
Martillos

Ø 42 mm

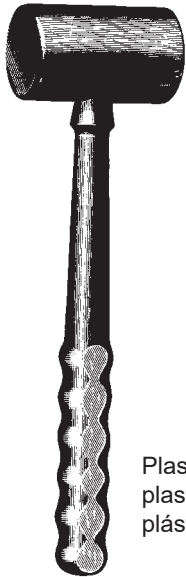

Plastik
plastic
plástico

33695-40
26 cm, 10 ¼"
400 g

Ø 12 mm



QUISLING
33696-75
17 cm, 6 ¾"

Ø 22 mm



PARTSCH
33698-98
18 cm, 7" 199 g

Ø 30 mm



COTTLE
33700-05
18 cm, 7" 240 g

Nasensonde, Dilatoren
Nasal Probe, Dilators
Sondas nasales, Diladores



RITTER-HALLE
16 cm, 6 1/4"
47342-25 Ø 2,5 mm
47342-30 Ø 3,0 mm
47342-40 Ø 4,0 mm



SINUS
47420-03
18 cm, 7"



FRONTAL
47427-21
21 cm, 8 1/2"



WILDER
43602-01



WILDER
43602-02



WILDER
43602-03

Sonden
Probes
Sondas

geknöpft
buttoned
abotonada



rostfrei
stainless steel
acero inoxidable

Fig.	BOWMAN	Ø mm
0000/000	43613-00	0,6/0,7
00/0	43614-00	0,7/0,8
0/1	43614-01	0,8/0,9
1/2	43614-12	0,9/1,1
2/3	43614-23	1,1/1,3
3/4	43614-34	1,3/1,4
4/5	43614-45	1,4/1,5
5/6	43614-56	1,5/1,6
6/7	43614-67	1,6/1,8
7/8	43614-78	1,8/1,9

Wundhaken
Retractors
Separadores

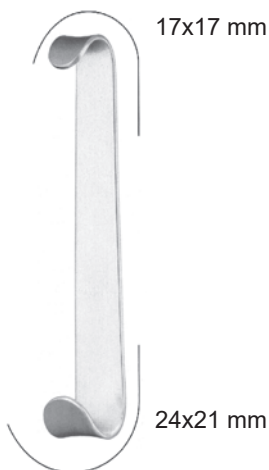

ROUX BABY
19122-13
13 cm, 5 1/8"

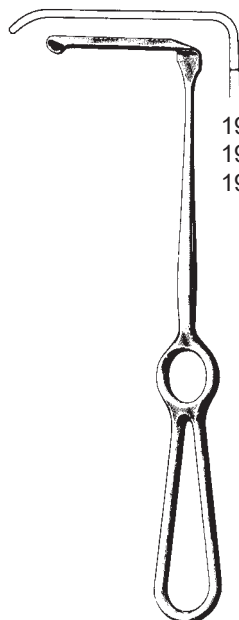

KOCHER-LANGENBECK
21 cm, 8 1/4"

- 19314-07 35x 7 mm
- 19314-14 70x14 mm
- 19314-20 60x20 mm

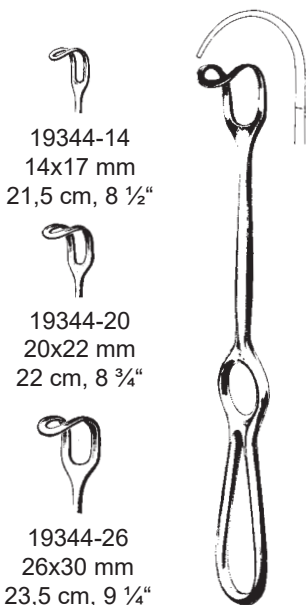

19344-14
14x17 mm
21,5 cm, 8 1/2"

19344-20
20x22 mm
22 cm, 8 3/4"

19344-26
26x30 mm
23,5 cm, 9 1/4"

MIDDELDORPF



BRÜNINGS-BRUNK
19499-00 19 cm, 7 1/2"

Kieferhöhlenhaken
Antrum Retractor
Separador para antro

Wundspreizer
Self-retaining Retractors
Separadores autoestáticos

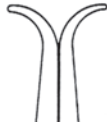
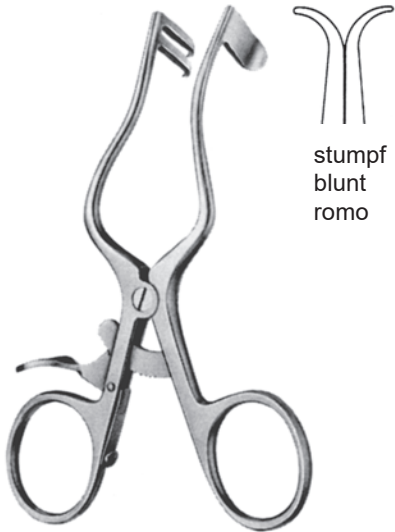

stumpf
blunt
romo

PLESTER
19672-11
11 cm, 4 3/8"

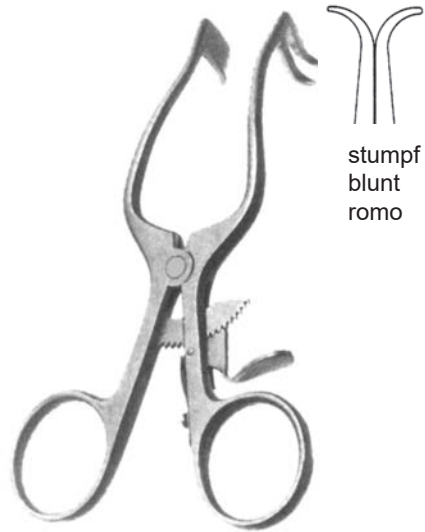

stumpf
blunt
romo

PLESTER
19673-11
11 cm, 4 3/8"



2x2

scharf
sharp
agudo

PLESTER
19677-10 10 cm, 4"
19677-13 13 cm, 5 1/8"

Wundspreizer
Self-retaining Retractors
Separadores autoestáticos



FISCH
19690-17
17 cm, 6 ¾"



FISCH
19691-17
17 cm, 6 ¾"

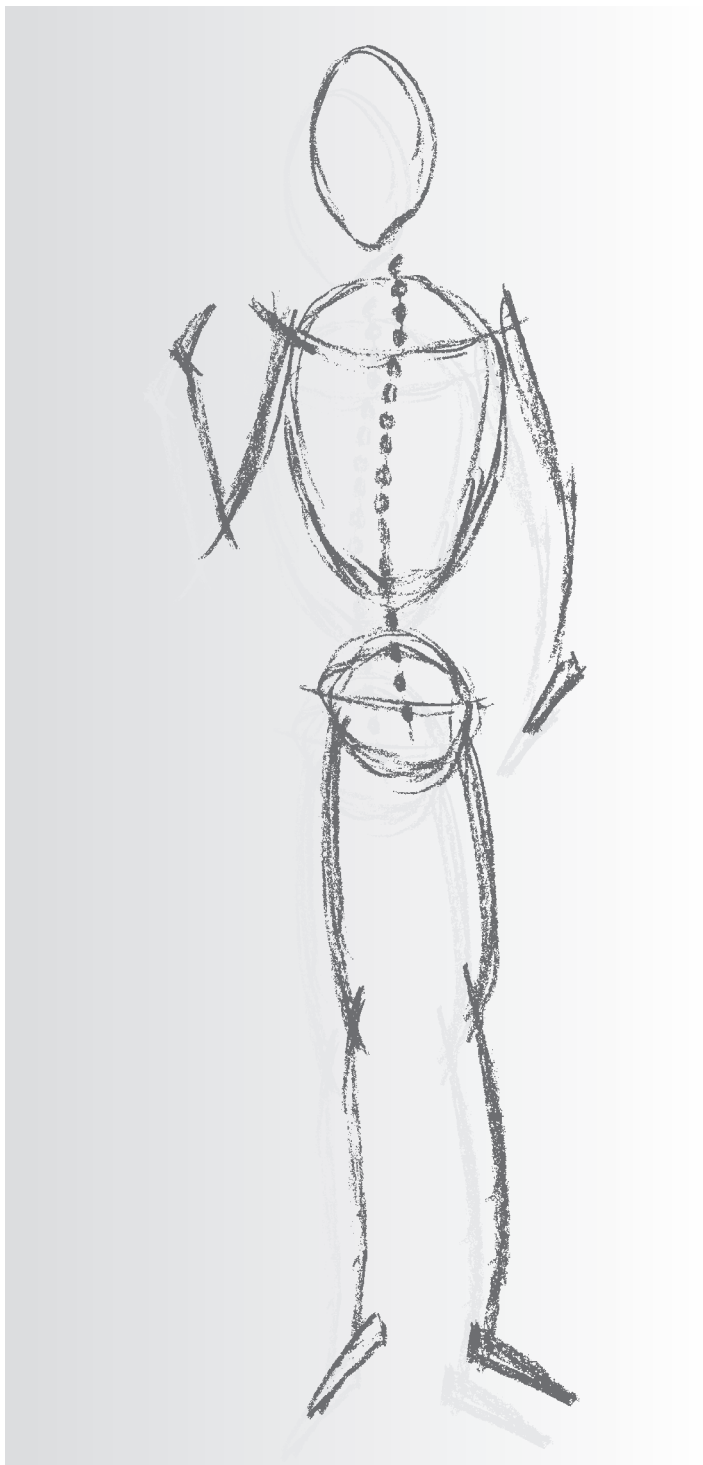

Reda Instrumente GmbH
Gänsäcker 34 - P.O. Box 131
D-78532 Tuttlingen

ADENOTOMIE UND
TONSILLEKTOMIE

ADENOTOMY AND
TONSILLECTOMY

ADENOTOMÍA Y
TONSILECTOMÍA

Zungenspatel, Wangen- und Lippenhalter
 Tongue Depressors, Cheek and Lip Retractors
 Baja-lenguas, Separadores para labios y mejillas

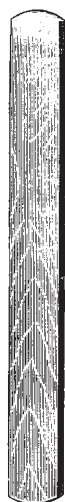

Holz
 wood
 madera

49102-16
 16 cm, 6 1/4"
 Pack. à 100

19 mm



23 mm

KROENIG
 49104-15
 15 cm, 6"

23 mm

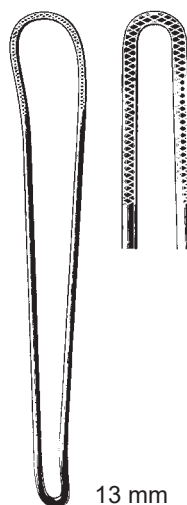

13 mm

FRENZEL
 49105-16
 16,5 cm, 6 1/2"

16 mm



49106-01
 14,5 cm, 5 3/4"

15 mm



19 mm

BRUENINGS
 49107-19
 19 cm, 7 1/2"

20 mm



20 mm

CAWOOD-MINNESOTA
 49108-15
 15 cm, 6"

23 mm



19 mm

BUCHWALD
 49109-19
 19 cm, 7 1/2"

Zungendrucker
Tongue Depressors
Baja-lenguas



MORITZ-SCHMIDT
49110-19
19 cm, 7 1/2"



HARTMANN
49111-15
15 cm, 6"



49115-01
Fig. 1
14 cm, 5 1/2"



49115-02
Fig. 2
15 cm, 6"

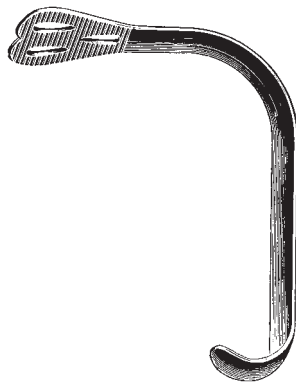

WIEDER
49115-01 - 49115-02

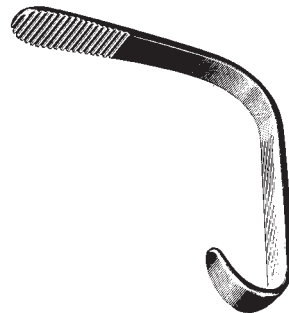

ANDREW
49117-11
11 cm, 4 3/8"

Zungendrucker, Wangen- und Lippenhalter, Zungenzangen
 Tongue Depressor, Cheek and Lip Retractor, Tongue Holding Forceps
 Baja-lenguas, Separadores para labios y mejillas, Pinza tira-lenguas

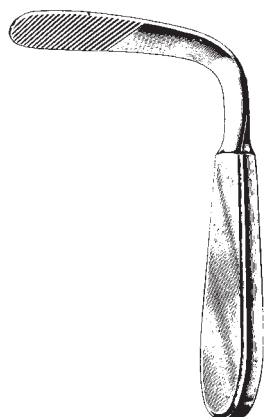

TOBOLD
 49119-14
 14,5 cm, 5 3/4"

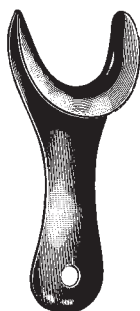

49230-11
 11 cm, 4 3/8"



STERNBERG
 49231-12 12 cm, 4 3/4"
 49231-14 14 cm, 5 1/2"
 49231-16 16 cm, 6 1/4"



49235-19
 19 cm, 7 1/2"

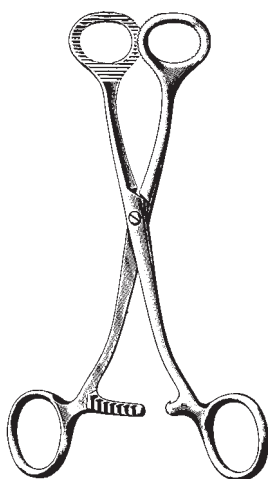

COLLIN
 49250-16 16 cm, 6 1/4"
 49250-18 18 cm, 7"

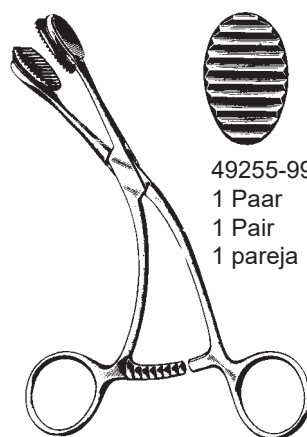

YOUNG
 49255-16
 16 cm, 6 1/4"

49255-99
 1 Paar
 1 Pair
 1 pareja

Mundsperrer
Mouth Gags
Abre-Bocas

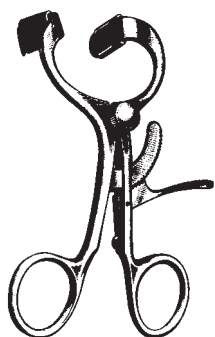

DOYEN-JANSEN (MOLT)
49265-12
12 cm, 4 3/4"

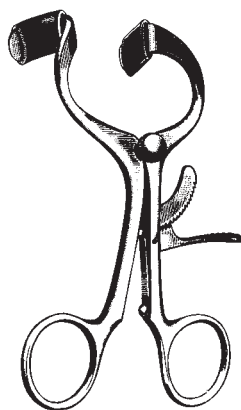

DOYEN-JANSEN (MOLT)
49265-14
14 cm, 5 1/2"

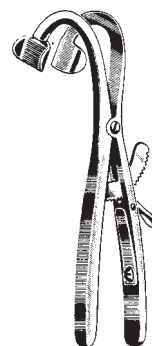

DENHART
49267-12
12 cm, 4 3/4"

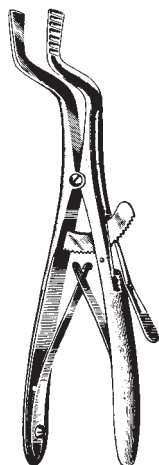

ROSER-KOENIG
49270-16 16 cm, 6 1/4"
49270-19 19 cm, 7 1/2"

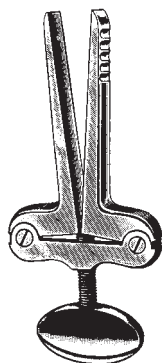

HEISTER
49272-13
13 cm, 5 1/8"

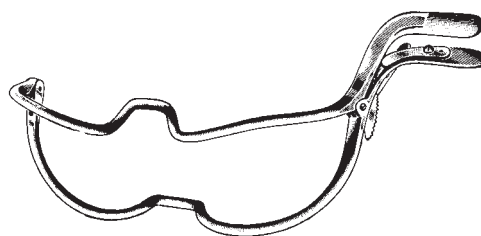

JENNINGS
49274-09 9 cm, 3 1/2"
49274-11 11 cm, 4 3/8"
49274-13 13 cm, 5 1/8"
49274-15 15 cm, 6"

Zungenspatel
Tongue Depressor
Baja-lengua

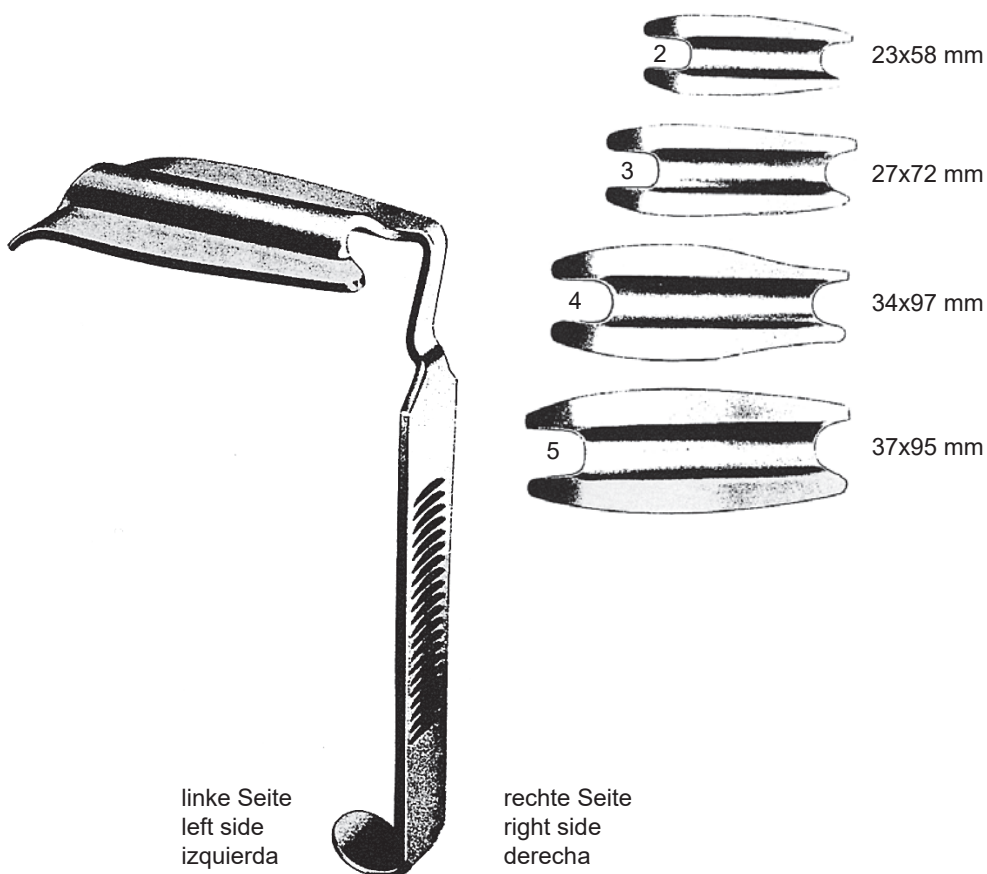

linke Seite
left side
izquierda

rechte Seite
right side
derecha

49287-02
49287-03
49287-04
49287-05

RING
Fig. 2
Fig. 3
Fig. 4
Fig. 5

49288-02
49288-03
49288-04
49288-05

Zungenspatel
Tongue Depressor
Baja-lengua

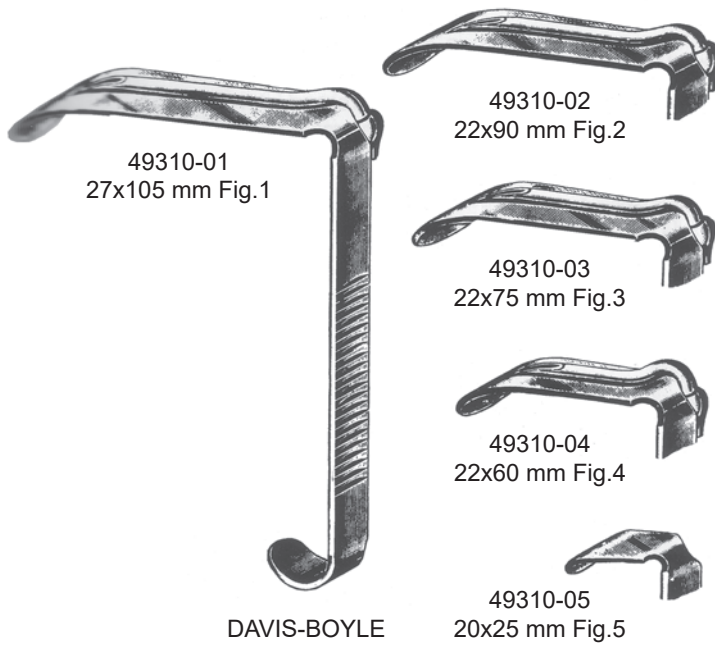

Mundsperrer
Mouth Gags
Abre-Bocas



Sperrer allein
Mouth Gag only
Abre-boca suelto

DAVIS-BOYLE

	für Erwachsene for adults para adultos	für Kinder for children para niños
links left izquierda	49310-10	49310-11
rechts right derecha	49310-12	49310-09

Mundsperrer
Mouth Gag
Abre-Bocas

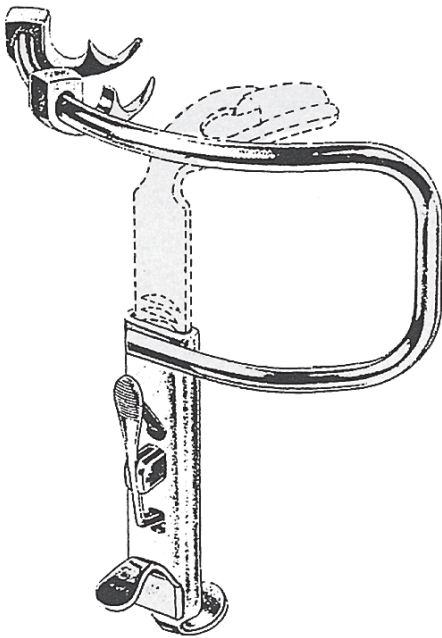

49315-10
Sperrer allein
Mouth Gag only
Abre-boca suelto

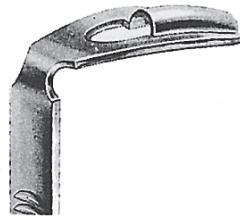

49315-01
37 x 80 mm
Fig. 1



49315-02
32 x 75 mm
Fig. 2

KILNER-DOUGHTY
49315-00
compl.

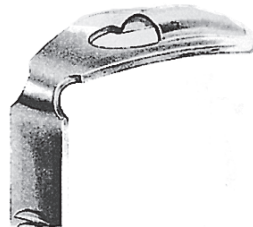

49315-03
28 x 65 mm
Fig. 3

Mundsperrer
Mouth Gag
Abre-Bocas

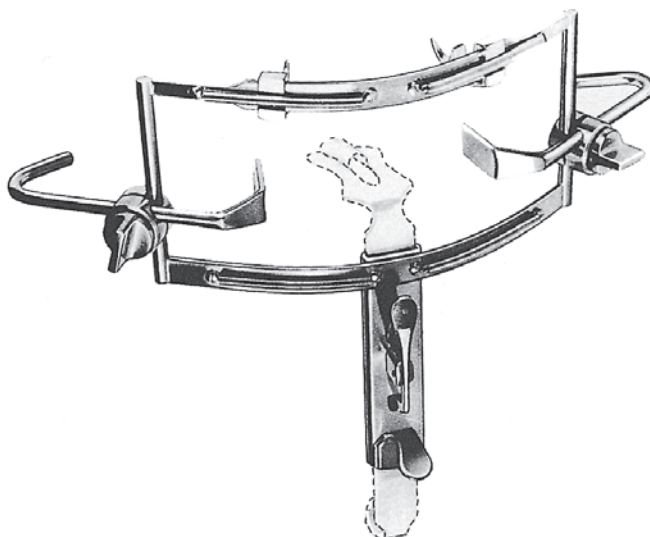

DINGMANN
49317-10
Sperrer allein / Mouth Gag only
Abre-boca suelto

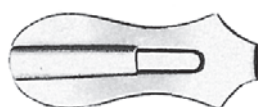

1 24x62 mm
49317-01

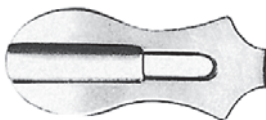

2 28x65 mm
49317-02

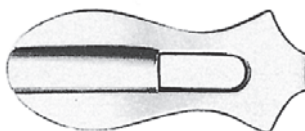

3 31x75 mm
49317-03

49317-00 DINGMANN, compl.
mit 3 auswechselbaren Zungendrucker,
2 seitliche Wangenhaken und 2 Zahnhaken
with 3 interchangeable tongue depressors,
2 rotating cheek holders
2 movable tooth hooks and thread guide
con 3 baja-lenguas intercambiables,
2 valvas giratorias p. los labios,
2 ganchos graduables

Mundsperrer, Gaumenplatte
 Mouth Gags, Palate Blade
 Abre-Bocas, placa para el paladar

49320-20
 Silikon-Schlauch
 Silicone Tubing
 tubo de silicona

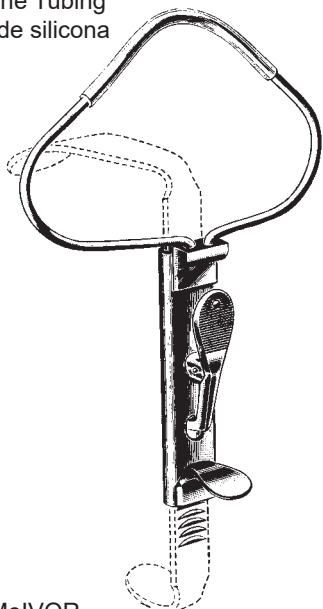

McIVOR
 49320-00
 compl.

49320-10

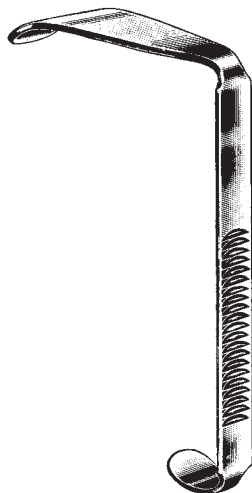

49320-01
 27x95 mm Fig. 1

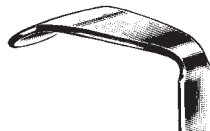

49320-02
 22x85 mm Fig. 2

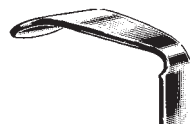

49320-03
 22x70 mm Fig. 3



DAVIS-MEYER
 49340-00



49341-00

Zungenspatel
Tongue Blades
Baja-lenguas



Zungenspatel
Tongue Blades
Baja-lenguas

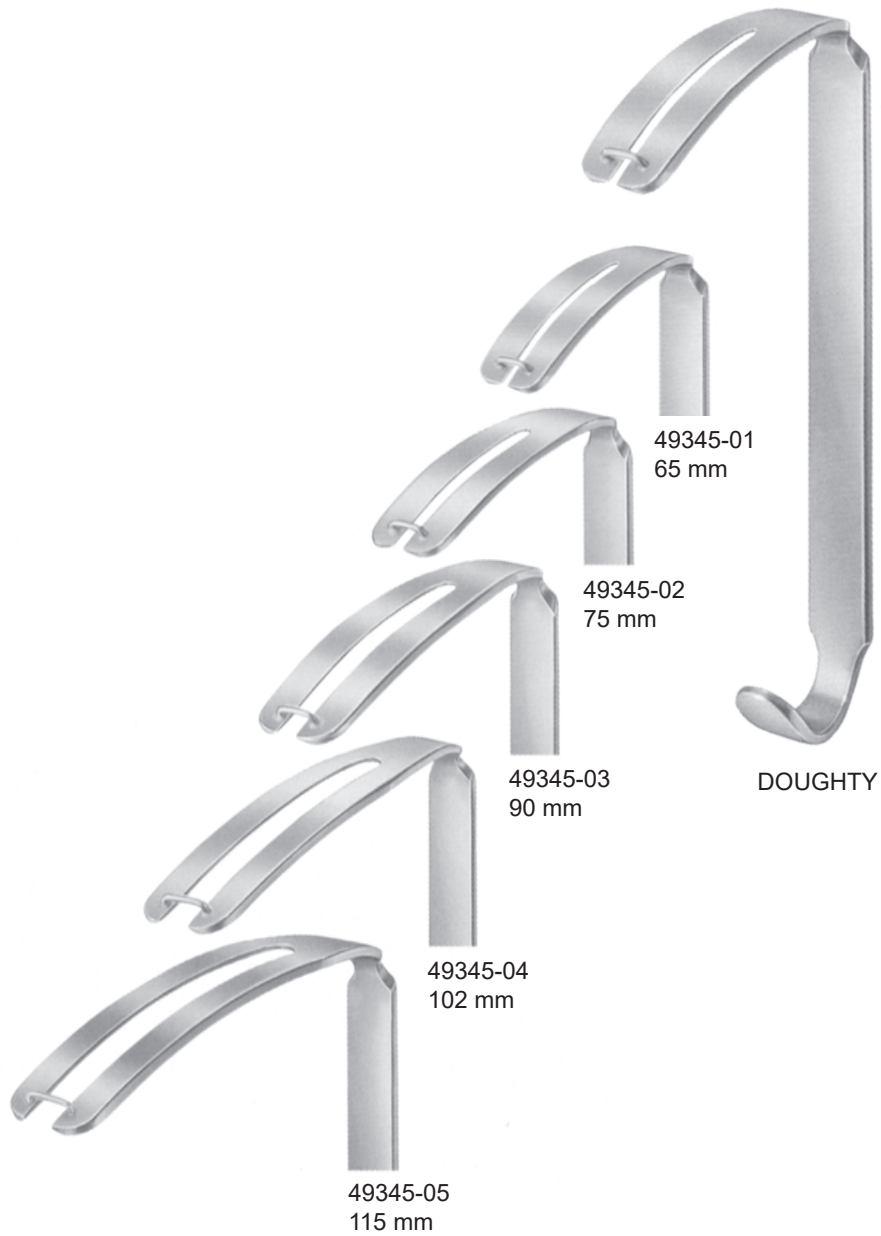

Mundkeil, Bruststütze
Oral Wedges, Chest Support
Abre-Bocas, Soporte de pecho

Holz
wood
madera



MAUNDER
49360-10



NEGUS
49400-01

Tonsillenzangen
Tonsil Forceps
Pinzas para coger las amígdalas

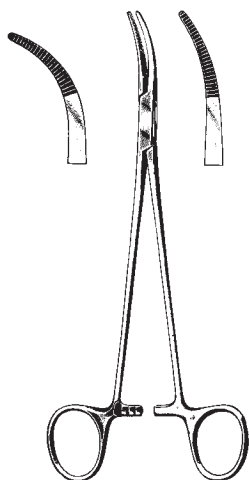

19 cm, 7 ½"
SAWTELL SCHNIDT
51181-19 51183-19

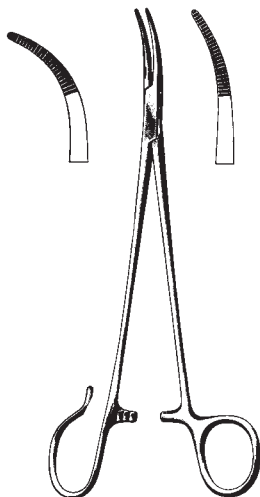

19 cm, 7 ½"
SAWTELL SCHNIDT
51185-19 51187-19

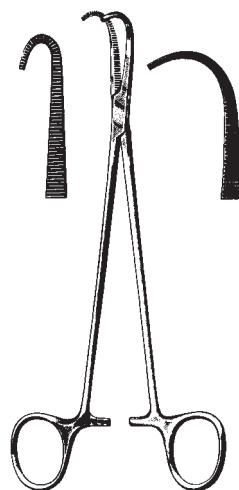

19 cm, 7 ½"
NEGUS NEGUS
51191-19 51193-19

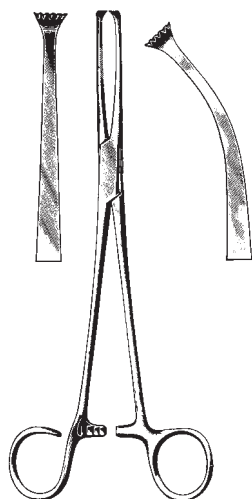

19 cm, 7 ½"
COLVER
51202-19 51203-19

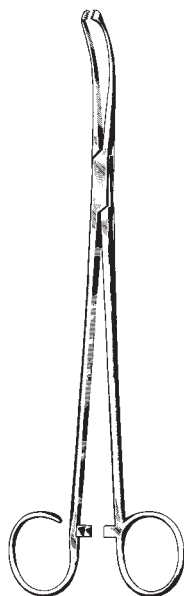

WHITE
51205-18 18 cm, 7"
51205-23 23 cm, 9"

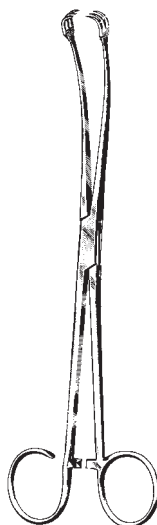

BALLENGER
51207-21
21,5 cm, 8 ½"

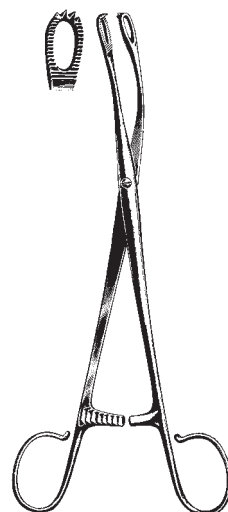

BLOHMKE
51209-20
20 cm, 8"

Tonsillenzangen, Tonsillenpinzette
Tonsil Forceps
Pinzas para amígdalas



ABRAHAM
51210-20
20 cm, 8"

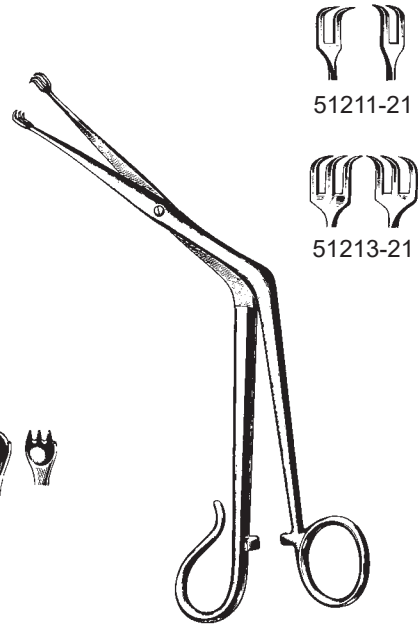

TYDING
21 cm, 8 1/4"

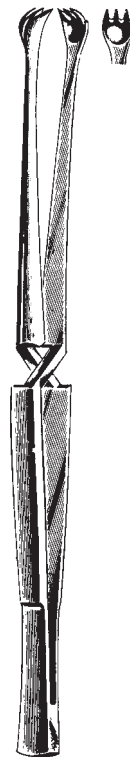

MARSCHIK
51219-22
22 cm, 8 3/4"

Tonsillenklemme, Tonsillenzange
Tonsil Forceps
Pinzas para amígdalas

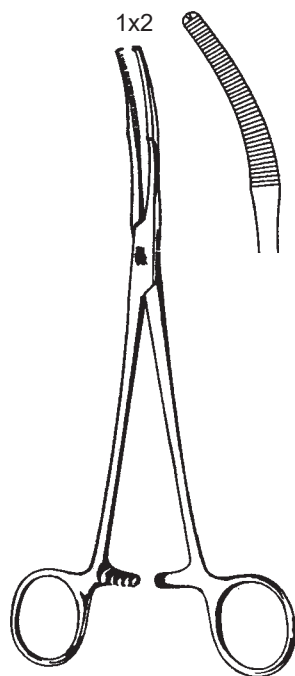

MIKULICZ
13551-18 18 cm, 7"



DENIS BROWNE
51214-20 20 cm, 8"



Tonsillenabszeßzange
Tonsil Abscess Forceps
Pinza para abscesos
en amígdalas

THILENIUS
51215-20 19 cm, 7 1/2"

Saugrohr
Suction Tube
Tubo de succion

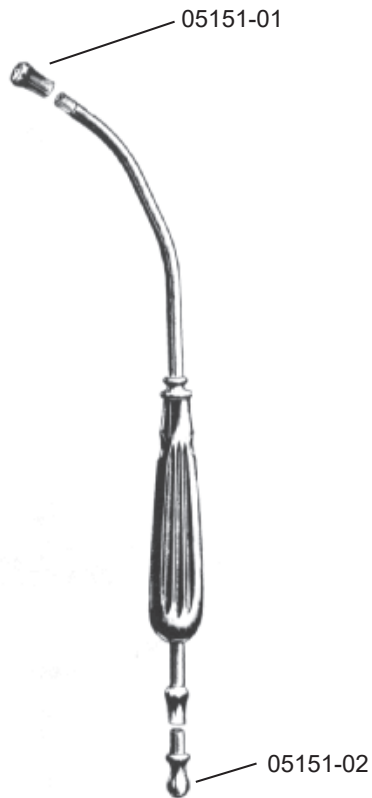

BABY-YANKAUER
05150-21 21 cm, 8 ¼"

YANKAUER, compl.
05150-27 27 cm, 10 ½"

Tonsillennadeln
Tonsil Needles
Agujas para amígdalas

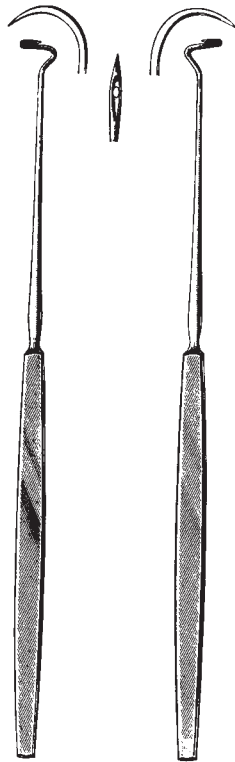

DUPUY-WEISS
51165-22 51167-22
22 cm 8 3/4"



CLAUS
51168-23
23 cm 9"

Tonsillennadeln, Tonsillenmesser
Tonsil Needles, Tonsil Knives
Agujas para amígdalas, Bisturios para amígdalas



NAGER
51170-24
24 cm 9 ½"



FISHER
51171-22
22,5 9"

Tonsillenmesser
Tonsil Knives
Bisturies para amígdalas



ABRAHAM
51172-19
19 cm, 7 ½"



ABRAHAM
51173-21
21 cm, 8 ¼"



CANFIELD
51174-21
21 cm, 8 ¼"



BRUENINGS
51177-23
23 cm, 9"

Uvulahaken
Uvula Retractors
Separadores uvulares

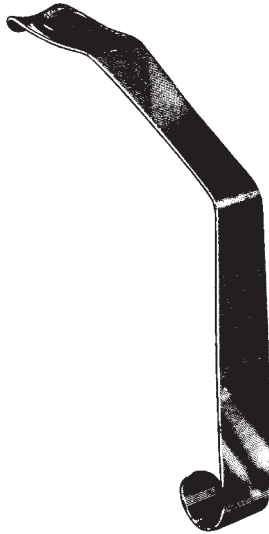

LOVE 15 cm, 6"
51103-18 18 mm
51103-20 20 mm
51103-22 22 mm

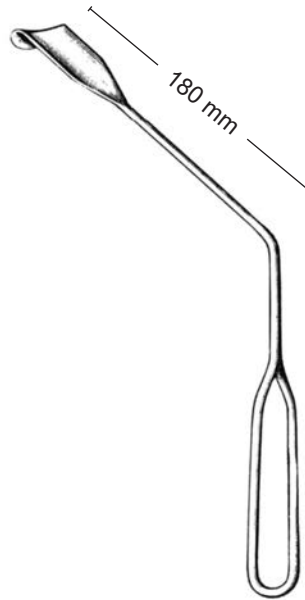

LOTHROP
51104-18 18 mm

Gaumensegelhalter
Soft Palate Retractors
Separadores para la vela palatina



HOFER
51109-24
24 cm, 9 1/2"



NAGER
51111-23
23 cm, 9"

Tonsillenelevatoren, Tonsillendissektoren
 Tonsil Elevators, Tonsil Dissectors
 Elevadores/disectores para amígdalas

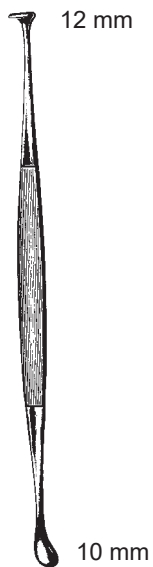

HURD
 51131-22
 22 cm, 8 1/4"



LOPEZ-REINKE
 51133-23
 23 cm, 9"



YANKAUER
 51134-21
 21 cm, 8 1/4"

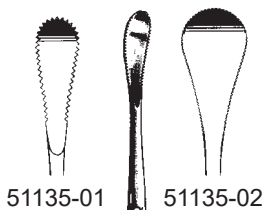

HENKE
 23 cm, 9"



ALDERDYCE
 33761-21
 21 cm, 8 1/4"

Tonsillendissektoren
Tonsil Dissectors
Disectores para amígdalas

E nukleator
E nukleator
E nukleador



CARPENTER
51139-25
25 cm, 10"

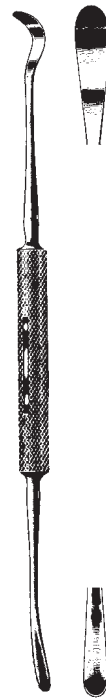

CARPENTER
51143-24
24 cm, 9 1/2"

Tamponstopfer
Gauze Packer
Tamponador tonsilar

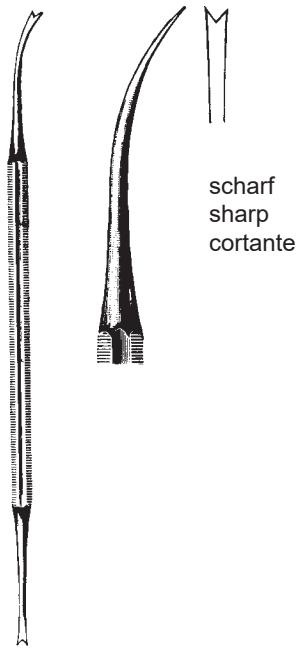

LUNIATSCHEK
51151-19
19 cm, 7 ½"

Speichelgangsonde
Salivary Duct Probe
Sonda para el canal de saliva

geknöpft
buttoned
abotonada



rostfrei
stainless steel
acero inoxidable

Fig.	BOWMAN	Ø mm
0000/000	43613-00	0,6/0,7
00/0	43614-00	0,7/0,8
0/1	43614-01	0,8/0,9
1/2	43614-12	0,9/1,1
2/3	43614-23	1,1/1,3
3/4	43614-34	1,3/1,4
4/5	43614-45	1,4/1,5
5/6	43614-56	1,5/1,6
6/7	43614-67	1,6/1,8
7/8	43614-78	1,8/1,9

Anatomische und chirurgische Pinzetten
Dressing and Tissue Forceps
Pinzas de disección, sin/con dientes



POTTS-SMITH

- | | | |
|----------|-------------|-------------|
| 11112-18 | 18 cm, 7" | 11116-18 TC |
| 11112-21 | 21 cm, 8 ¼" | 11116-21 TC |
| 11112-25 | 25 cm, 10" | 11116-25 TC |



1x2

POTTS-SMITH

- | | |
|----------|-------------|
| 11126-18 | 18 cm, 7" |
| 11126-21 | 21 cm, 8 ¼" |
| 11126-25 | 25 cm, 10" |

Tupferzangen
Dressing Forceps
Pinzas porta-esponjas



DUPLAY
17131-21 21 cm, 8 ¼"



17133-17 17 cm, 6 ¾"

Tonsillenscheren
Tonsil Scissors
Tijeras para amígdalas

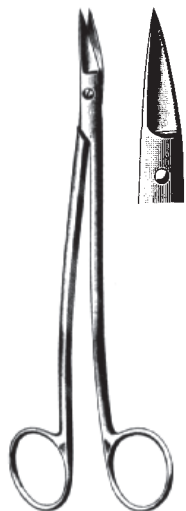

— DEAN —
09425-17 09427-17
17 cm, 6 ¾"

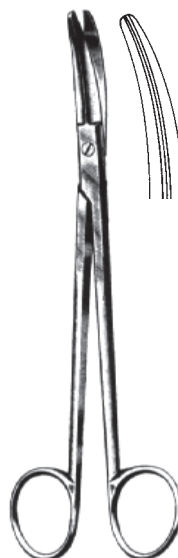

BOETTCHER
09435-18
18 cm, 7"



GOOD
09437-19
19 cm, 7 ½"

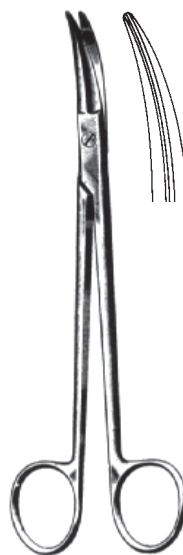

PRINCE
09439-17
17 cm, 6 ¾"

Präparierscheren
Dissecting Scissors
Tijeras de disección

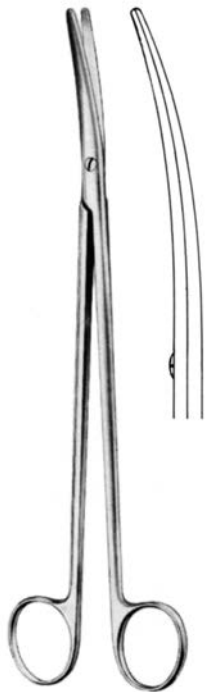

METZENBAUM

- 09281-12 **09285-12 TC**
12 cm 4 ¾"
- 09281-15 **09285-15 TC**
15 cm 6"
- 09281-18 **09285-18 TC**
18 cm 7"
- 09281-20 **09285-20 TC**
20 cm 8"
- 09281-23 **09285-23 TC**
23 cm 9"
- 09281-25 **09285-25 TC**
25 cm 10"
- 09281-28 **09285-28 TC**
28 cm 11"
- 09281-30 **09285-30 TC**
30 cm 12"

Speichelgangschere
Salival Scissors
Tijeras para el canal de saliva

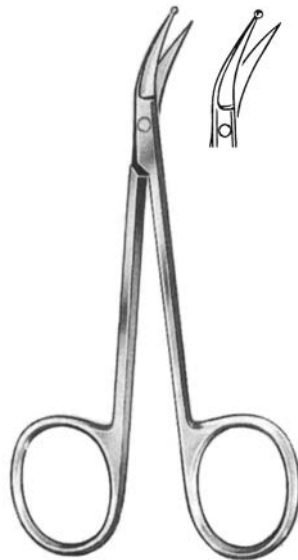

PERWITZSCHKY
09364-10
10 cm, 4"

Draht-, Blehschere
Wire and Plate Scissors
Tijeras para alambre y láminas



UNIVERSAL

09831-12 12 cm, 4 3/4"

09835-12 TC 12 cm, 4 3/4"

Tonsillenschnürer
Tonsil Snares
Cierranudos para amígdalas

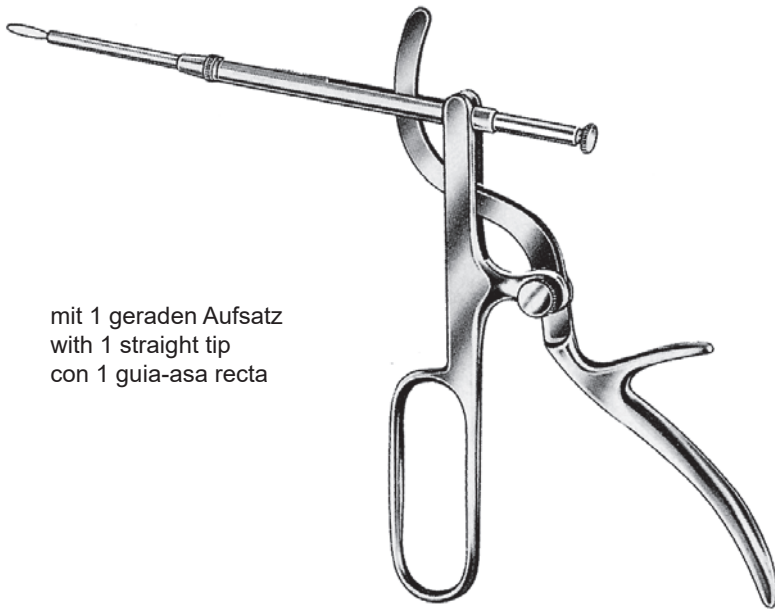

mit 1 geraden Aufsatz
with 1 straight tip
con 1 guía-asa recta

TYDING
51260-00

Tonsillenschnürer
Tonsil Snares
Cierranudos para amígdalas



EVES
51250-28
28 cm, 11"



EVES
51252-28
28 cm, 11"



BRUENINGS
51256-28
28 cm, 11"

Tonsillendraht
Tonsil Wire
Hilos para amígdalas

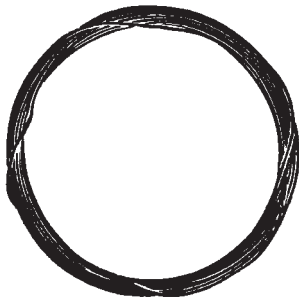

mm Ø
34520-02 0,2
34520-03 0,3
34520-04 0,4

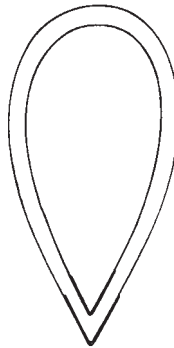

51257-40 40 mm
51257-50 50 mm
Pack of 100 pcs



51259-03 0,3 mm
51259-04 0,4 mm
51259-05 0,5 mm
Pack of 12 pcs

Tonsillenschnürer
Tonsil Snares
Cierranudos para amígdalas

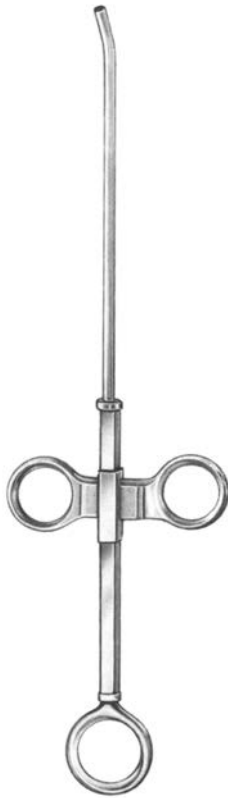

ROEDER "E"
51265-00
27 cm, 10 ³/₄"

Fadengabel
Knot Tier
Horquilla de hilos



NEGUS
51176-20
20,5 cm, 8"

Tonsillotom
Tonsillectome
Amigdalótom



SLUDER-BALLENGER
51270-00
mit 3 Aufsätzen
with 3 blades
con 3 hojas

Septum Nadeln, Spritzen
 Septum Needles, Syringes
 Agujas para septum, Jeringas



51291-00
 2,5 mm Ø

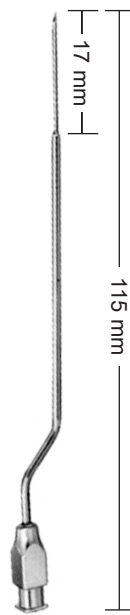

51293-00
 0,8 mm Ø



51293-90
 90°



51293-45
 45°



51292-00

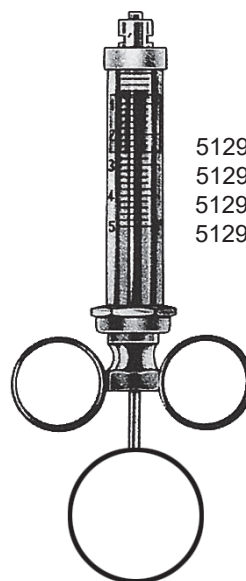

51290-02 2 ml
 51290-05 5 ml
 51290-10 10 ml
 51290-20 20 ml

Tonsillenzangen
Tonsil Punches
Pinzas para amígdalas

scharf
sharp
cortante

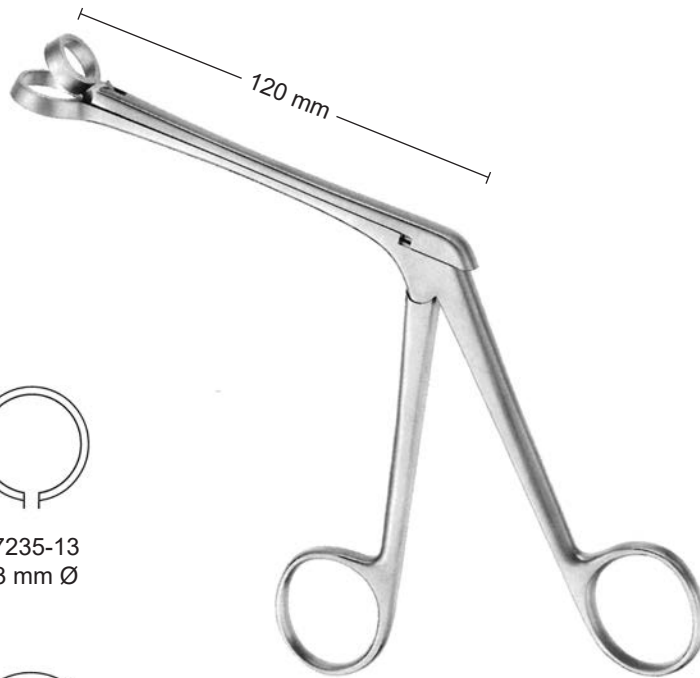

47235-13
13 mm Ø



47235-15
15 mm Ø

HARTMANN

Ringmesser
Adenoid Curettes
Cuchillos para vegetaciones adenoideas



BECKMANN
22 cm, 8 3/4"

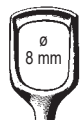

47620-00
Fig. 0

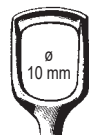

47620-01
Fig. 1

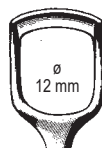

47620-02
Fig. 2

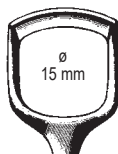

47620-03
Fig. 3

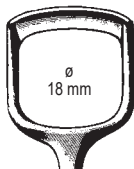

47620-04
Fig. 4

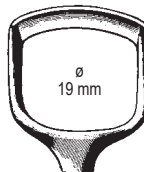

47620-05
Fig. 5

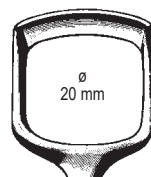

47620-06
Fig. 6



BARNHILL
21 cm, 8 1/4"



47630-00
Fig. 0

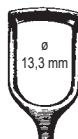

47630-01
Fig. 1

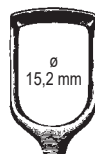

47630-02
Fig. 2

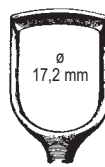

47630-03
Fig. 3

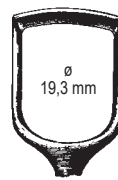

47630-04
Fig. 4

Ringmesser, Adenotome
Adenoid Currettes, Adenotomes
Cuchillos para vegetaciones adenoideas, Adenotomos



St. CLAIR-THOMSON
21 cm, 8 1/4"

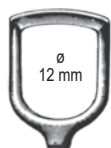

47636-01
Fig. 1



47636-02
Fig. 2

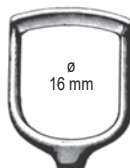

47636-03
Fig. 3

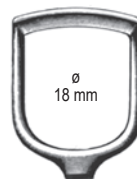

47636-04
Fig. 4



LAFORCE
25 cm, 10"



47641-01
Fig. 1
ø 12 mm



47641-02
Fig. 2
ø 16 mm



47641-03
Fig. 3
ø 18 mm

Ersatzklingen allein, gelocht
Spare blades, perforated
Hojas de repuesto, perforadas

Fig. 1 47642-01
Fig. 2 47642-02
Fig. 3 47642-03

Nasenrachenzangen
Naso Pharyngeal Forceps
Pinzas naso-faringeas



Nasenrachenzangen
Naso Pharyngeal Forceps
Pinzas naso-faringeas

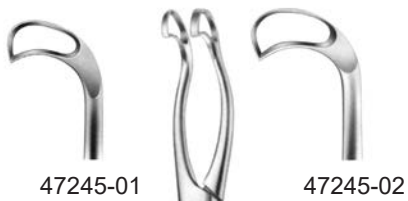

47245-01

47245-02



JURASZ
21 cm, 8 ¼"



für Kinder, scharf
for children, sharp
para niños, cortante

JURASZ
47244-00 19 cm, 7 ½"

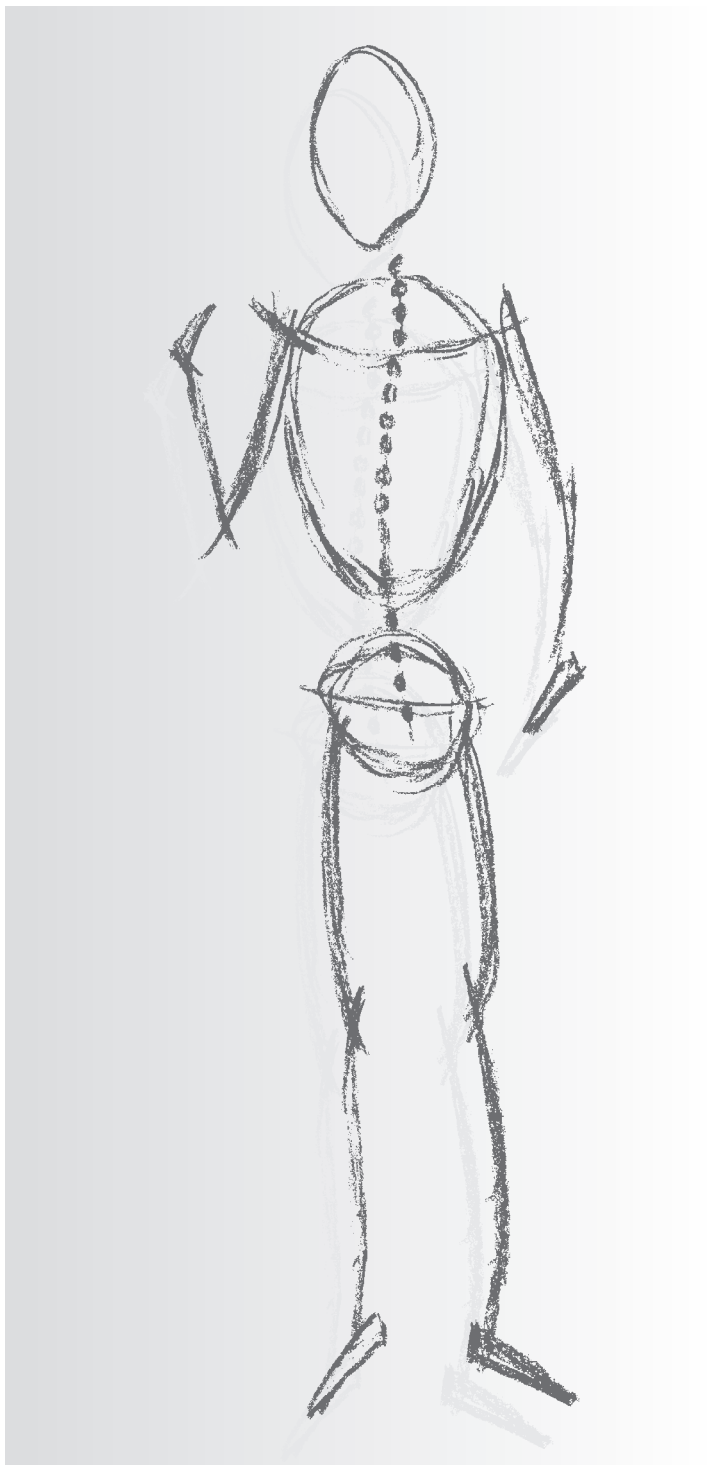

Reda Instrumente GmbH
Gänsäcker 34 - P.O. Box 131
D-78532 Tuttlingen

TRACHEOTOMIE

TRACHEOTOMY

TRAQUEOTOMÍA

Tracheal Dilatoren, Trachealhaken, Trachealwundspreizer
 Tracheal Dilators, Tracheal Hooks, Tracheal Retractors
 Dilatadores traqueales, Ganchos traqueales, Retractor traqueal

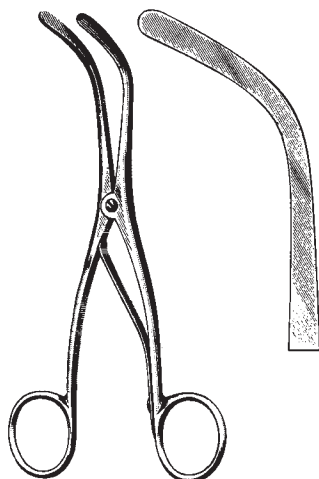

TROUSSEAU-BABY
 55111-13 13 cm, 5 1/8"

TROUSSEAU
 55111-14 14 cm, 5 1/2"

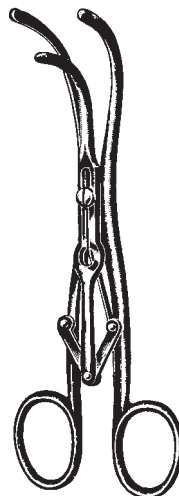

LABORDE
 55113-14
 14 cm, 5 1/2"



BOSE
 55115-07
 7 cm, 2 3/4"

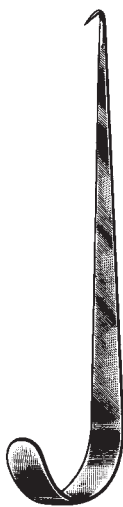

JACKSON
 55116-15
 15 cm, 6"

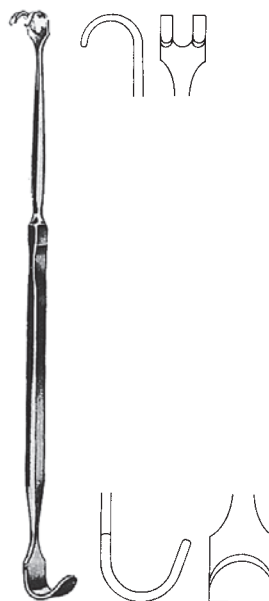

JACKSON
 55117-17
 17 cm, 6 3/4"

Trachealhaken, Kanülen
Tracheal Hooks, Tubes
Ganchos traqueales Cánulas



ITERSON
16 cm, 6 ¼"



NEWS
55120-15
15 cm, 6"



BOSE
55122-16
16 cm, 6 ¼"

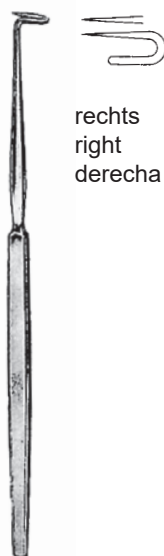

BOSE
55124-16
16 cm, 6 ¼"



WAGENER-MOSHER
55151-05 5 mm
55151-07 7 mm
55151-09 9 mm

Trachealkanülen
Tracheal Tubes
Canulas traqueales

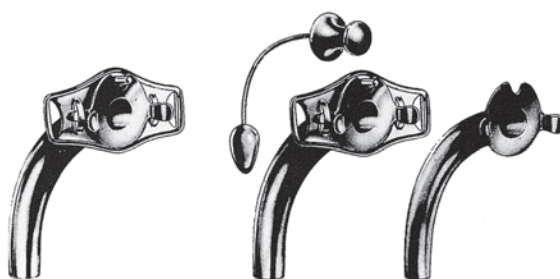

Fig.	Ø mm	Länge des Außenrohrs Length of outer tube Largo de la cánula exterior	LUER Neusilber German silver alpaca	CHEVALIER-JACKSON Neusilber German silver alpaca
0	4	45 mm	55220-04	55240-04
1	5	50 mm	55220-05	55240-05
2	6	55 mm	55220-06	55240-06
3	7	60 mm	55220-07	55240-07
4	8	65 mm	55220-08	55240-08
5	9	70 mm	55220-09	55240-09
6	10	75 mm	55220-10	55240-10
7	11	80 mm	55220-11	55240-11
8	12	85 mm	55220-12	55240-12
9	13	90 mm	55220-13	55240-13

Kropfsonde, Schilddrüsenhaken
Thyroid Dissectors, Thyroid Retractor
Sondas para bocio, Separador para la glándula tiroidea



55501-15



KOCHER
15 cm, 6"



55503-15



SCHOENBORN
55511-21
21 cm, 8 ¼"

Kropffäßzange, Muskelklemme
Goitre Seizing Forceps, Muscular Clamp
Pinza para coger el bocio, Pinza para músculos

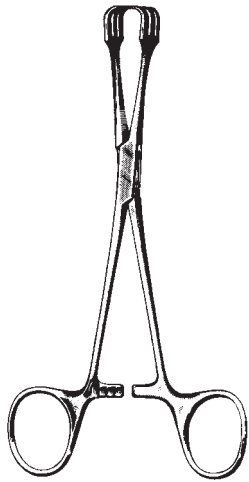

LAHEY
55520-15 15 cm, 6"
55520-20 20 cm, 8"

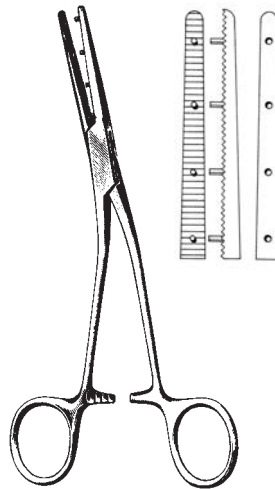

MASTIN
55523-17
17 cm, 6 3/4"

Kehlkopf Polypenschnürer
Laryngeal Polypus Snare
Cierranudo para pólipos



51259-04
Ø 0,4 mm
Pack of 12 pcs

Schnürerdraht
Snare Wire
Alambre para polipotomo



53122-00
Nutzlänge 24 cm, 9 ½"
Working length 24 cm, 9 ½"
Largo útil 24 cm, 9 ½"

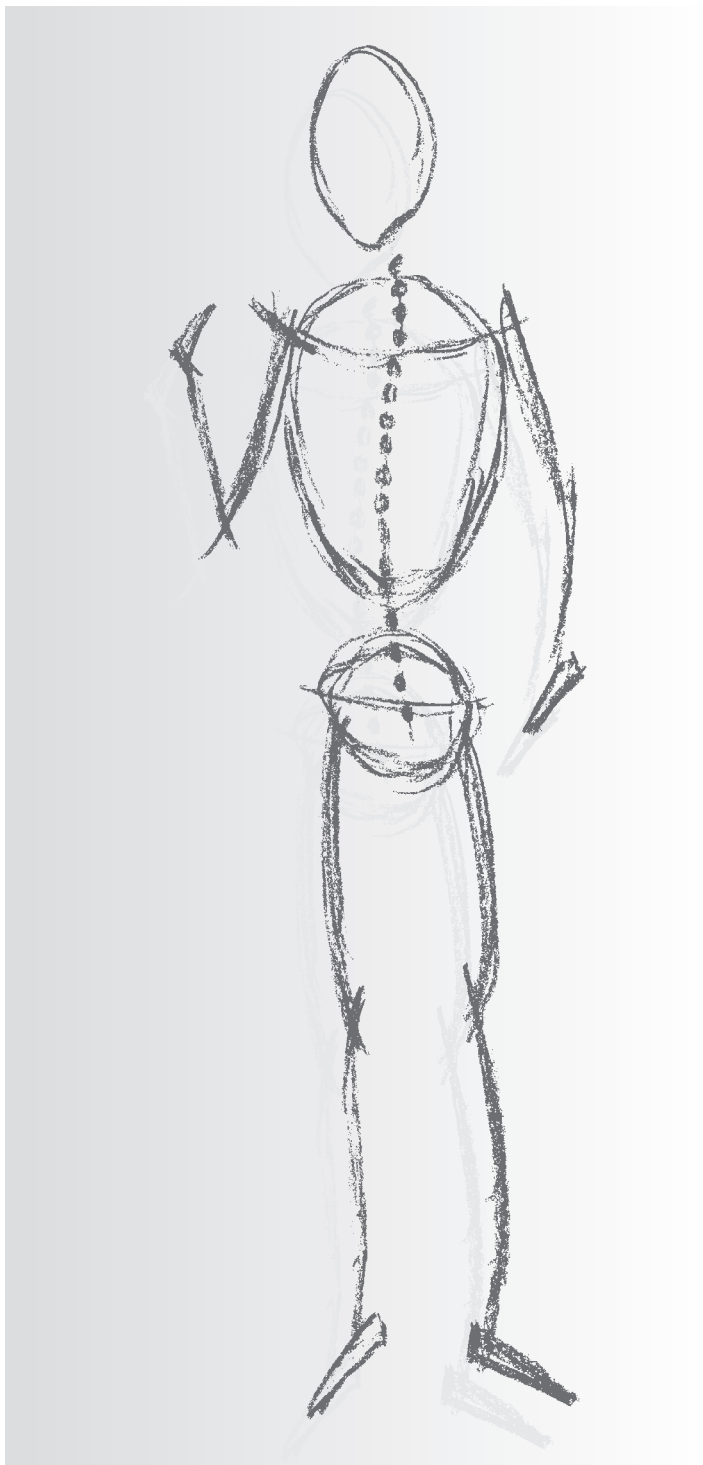

Reda Instrumente GmbH
Gänsäcker 34 - P.O. Box 131
D-78532 Tuttlingen

LARYNGOSKOPIE
ENDOLARYNGEALE
MIKROCHIRURGIE

LARYNGOLOGY
ENDOLARYNGEAL
MICROSURGERY

LARINGOSCOPIA
MICRO CIRUGIA
ENDOLARINGEAL

Kaltlicht Laryngoskope
Fiber Optic Laryngoscopes
Laringoscopios de luz fría



Kaltlicht
Cold Light
Luz fría



McINTOSH

05212-03

Set bestehend aus:

- 1 Etui
- 1 Batteriegriff 05238-03
- 3 Spatel (Fig. 2-4)
- 1 Ersatzlampe Xenon 05239-03

Set consisting of:

- 1 Case
- 1 Handle 05238-03
- 3 Blades (Fig. 2-4)
- 1 Spare Bulb Xenon 05239-03

Juego compuesto de:

- 1 Estuche
- 1 Mango 05238-03
- 3 Hojas (Fig. 2-4)
- 1 Bombilla de recambio Xenon 05239-03

05212-04

Set bestehend aus:

- 1 Etui
- 1 Batteriegriff 05238-03
- 4 Spatel (Fig. 1-4)
- 1 Ersatzlampe Xenon 05239-03

Set consisting of:

- 1 Case
- 1 Handle 05238-03
- 4 Blades (Fig. 1-4)
- 1 Spare Bulb Xenon 05239-03







Juego compuesto de:

- 1 Estuche
- 1 Mango 05238-03
- 4 Hojas (Fig. 1-4)
- 1 Bombilla de recambio Xenon 05239-03

Laryngoskopie-Spatel mit integriertem Kaltlichtträger
 Laryngoscope Blades with Integrated Cold Light Carrier
 Espátulas de laringoscopios con luz fría integrada

Kaltlicht
 Cold Light
 Luz fría



		McINTOSH	
		05211-00 59 mm, 2.32" Nutzlänge working length largo útil	Fig. 0 für Säuglinge for babies para neonatales
		05211-01 72 mm, 2.83" Nutzlänge working length largo útil	Fig. 1 für Kinder for children para niños
		05211-02 92 mm, 3.62" Nutzlänge working length largo útil	Fig. 2 für Jugendliche for adolescents para adolescentes
		05211-03 112 mm, 4.41" Nutzlänge working length largo útil	Fig. 3 für Frauen for women para mujeres
		05211-04 136 mm, 5.35" Nutzlänge working length largo útil	Fig. 4 für Männer for men para hombres

Laryngoskopie Spatel mit integriertem Kaltlichtträger
Laryngoscope Blades with Integrated Cold Light Carrier
Espátulas de laringoscopios con luz fría integrada



Kaltlicht
Cold Light
Luz fría



McCOY

		Nutzlänge working length largo útil
Fig. 2	05217-02	92 mm
Fig. 3	05217-03	112 mm
Fig. 4	05217-04	136 mm

Kaltlicht Laryngoskope
Fiber Optic Laryngoscopes
Laringoscopios de luz fría

Kaltlicht
Cold Light
Luz fría



MILLER

05213-03CL

Set bestehend aus:

- 1 Etui
- 1 Batteriegriff 05238-03
- 3 Spatel (Fig. 1-3)
- 1 Ersatzlampe Xenon 05239-03

Set consisting of:

- 1 Case
- 1 Handle 05238-03
- 3 Blades (Fig. 1-3)
- 1 Spare Bulb Xenon 05239-03

Juego compuesto de:

- 1 Estuche
- 1 Mango 05238-03
- 3 Hojas (Fig. 1-3)
- 1 Bombilla de recambio Xenon 05239-03

05213-04CL

Set bestehend aus:

- 1 Etui
- 1 Batteriegriff 05238-03
- 4 Spatel (Fig. 1-4)
- 1 Ersatzlampe Xenon 05239-03

Set consisting of:

- 1 Case
- 1 Handle 05238-03
- 4 Blades (Fig. 1-4)
- 1 Spare Bulb Xenon 05239-03

Juego compuesto de:

- 1 Estuche
- 1 Mango 05238-03
- 4 Hojas (Fig. 1-4)
- 1 Bombilla de recambio Xenon 05239-03

Laryngoskopie-Spatel mit integriertem Kaltlichtträger
Laryngoscope Blades with Integrated Cold Light Carrier
Espátulas de laringoscopios con luz fría integrada



Kaltlicht
Cold Light
Luz fría

MILLER



05230-00CL
55 mm, 2.16"
Nutzlänge
working length
largo útil

Fig. 0
für Säuglinge
for babies
para neonatales



05230-01CL
80 mm, 3.15"
Nutzlänge
working length
largo útil

Fig. 1
für Kinder
for children
para niños



05230-02CL
130 mm, 5.12"
Nutzlänge
working length
largo útil

Fig. 2
für Jugendliche
for adolescents
para adolescentes



05230-03CL
170 mm, 6.69"
Nutzlänge
working length
largo útil

Fig. 3
für Frauen
for women
para mujeres



05230-04CL
188 mm, 7.4"
Nutzlänge
working length
largo útil

Fig. 4
für Männer
for men
para hombres

Warmlicht
Warm Light
Luz caliente



Laryngoskope Warmlicht
Laryngoscopes Warm Light
Laringoscopios de luz caliente



McINTOSH

05203-00

Set bestehend aus:

- 1 Etui
- 1 Batteriegriff 05234-28
- 3 Spatel (Fig. 2-4)
- 2 Ersatzlampen 05239-02

Set consisting of:

- 1 Case
- 1 Handle 05234-28
- 3 Blades (Fig. 2-4)
- 2 Spare Bulbs 05239-02

Juego compuesto de:

- 1 Estuche
- 1 Mango 05234-28
- 3 Hojas (Fig. 2-4)
- 2 Bombilla de recambio 05239-02

05204-00

Set bestehend aus:

- 1 Etui
- 1 Batteriegriff 05234-28
- 4 Spatel (Fig. 1-4)
- 2 Ersatzlampen 05239-02

Set consisting of:

- 1 Case
- 1 Handle 05234-28
- 4 Blades (Fig. 1-4)
- 2 Spare Bulbs 05239-02

Juego compuesto de:

- 1 Estuche
- 1 Mango 05234-28
- 4 Hojas (Fig. 1-4)
- 1 Bombilla de recambio 05239-02

Laryngoskopie-Spatel mit integriertem Warmlichtträger
Laryngoscope Blades with Integrated Warm Light Carrier
Espátulas de laringoscopios con luz caliente integrada



Warmlicht
Warm Light
Luz caliente

McINTOSH



05210-00
59 mm, 2.32"
Nutzlänge
working length
largo útil

Fig. 0
für Säuglinge
for babies
para neonatales



05210-01
72 mm, 2.83"
Nutzlänge
working length
largo útil

Fig. 1
für Kinder
for children
para niños



05210-02
92 mm, 3.62"
Nutzlänge
working length
largo útil

Fig. 2
für Jugendliche
for adolescents
para adolescentes



05210-03
112 mm, 4.41"
Nutzlänge
working length
largo útil

Fig. 3
für Frauen
for women
para mujeres



05210-04
136 mm, 5.35"
Nutzlänge
working length
largo útil

Fig. 4
für Männer
for men
para hombres

Warmlicht
Warm Light
Luz caliente



Laryngoskope Warmlicht
Laryngoscopes Warm Light
Laringoscopios de luz caliente



MILLER

05213-03

Set bestehend aus:

- 1 Etui
- 1 Batteriegriff 05234-28
- 3 Spatel (Fig. 1-3)
- 1 Ersatzlampe 05239-01
- 1 Ersatzlampe 05239-02

Set consisting of:

- 1 Case
- 1 Handle 05234-28
- 3 Blades (Fig. 1-3)
- 1 Spare Bulb 05239-01
- 1 Spare Bulb 05239-02

Juego compuesto de:

- 1 Estuche
- 1 Mango 05234-28
- 3 Hojas (Fig. 1-3)
- 1 Bombilla de recambio 05239-01
- 1 Bombilla de recambio 05239-02

05213-04

Set bestehend aus:

- 1 Etui
- 1 Batteriegriff 05234-28
- 4 Spatel (Fig. 1-4)
- 1 Ersatzlampe 05239-01
- 1 Ersatzlampe 05239-02

Set consisting of:

- 1 Case
- 1 Handle 05234-28
- 4 Blades (Fig. 1-4)
- 1 Spare Bulb 05239-01
- 1 Spare Bulb 05239-02

Juego compuesto de:

- 1 Estuche
- 1 Mango 05234-28
- 4 Hojas (Fig. 1-4)
- 1 Bombilla de recambio 05239-01
- 1 Bombilla de recambio 05239-02

Laryngoskope Warmlicht
Laryngoscopes Warm Light
Laringoscopios de luz caliente



Warmlicht
Warm Light
Luz caliente

MILLER



05230-00
55 mm, 2.16"
Nutzlänge
working length
largo útil

Fig. 0
für Säuglinge
for babies
para neonatales



05230-01
80 mm, 3.15"
Nutzlänge
working length
largo útil

Fig. 1
für Kinder
for children
para niños



05230-02
130 mm, 5.12"
Nutzlänge
working length
largo útil

Fig. 2
für Jugendliche
for adolescents
para adolescentes



05230-03
170 mm, 6.69"
Nutzlänge
working length
largo útil

Fig. 3
für Frauen
for women
para mujeres



05230-04
188 mm, 7.4"
Nutzlänge
working length
largo útil

Fig. 4
für Männer
for men
para hombres

Laryngoskope Warmlicht
Laryngoscopes Warm Light
Laringoscopios de luz caliente

Warmlicht
Warm Light
Luz caliente

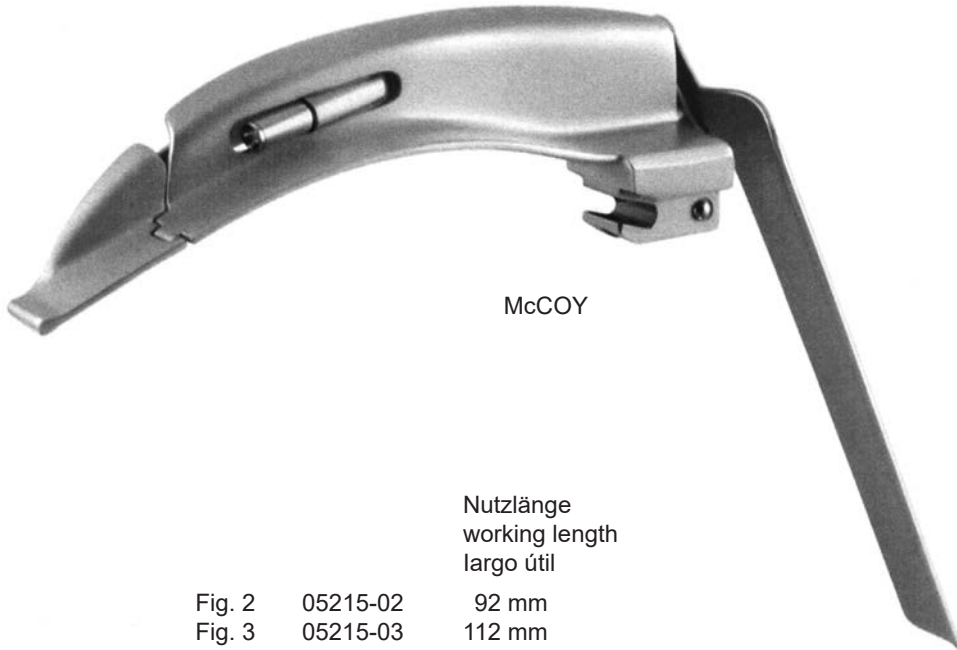

McCOY

		Nutzlänge working length largo útil
Fig. 2	05215-02	92 mm
Fig. 3	05215-03	112 mm
Fig. 4	05215-04	136 mm

Batteriegriffe, Edelstahl
 Battery Handles, Stainless Steel
 Mango de pila, acero inoxidable



Kaltlicht
 Cold Light
 Luz fría



15,5 cm
 19 mm Ø

05238-02



15,5 cm
 28 mm Ø

05238-03



05239-03 Xenon 2,5 V

Ersatzlampe
 Spare Bulb
 Bombilla de recambio

05238-12

05238-13

mit Xenon-Lampe
 with Xenon-Lamp
 con lampara Xenon

mit LED-Lampe
 with LED-Lamp
 con lampara LED

Warmlicht
Warm Light
Luz caliente



Batteriegriffe, Edelstahl
Battery Handles, Stainless Steel
Mango de pila, acero inoxidable



05233-18
14 cm
19 mm Ø



05234-28
14,5 cm
29 mm Ø



05239-01 2,5 V
Fig. 0-1



05239-02 2,5 V
Fig. 2-4

Ersatzlampe
Spare Bulb
Bombilla de recambio

Operations-Laryngoskope
 Operation Laryngoscope
 Laringoscopios operativo

rostfreier Edelstahl
 Rohr: innen matt/außen glänzend
 Griff: matt

stainless steel
 tube: inner surface mat/outer
 surface polished
 handle: mat

acero inoxidable
 Pala: Superficie interior: mate
 Superficie exterior: brillante
 Mango: mate

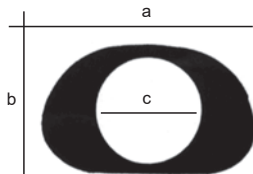

Nr.	L (mm)	a (mm)	b (mm)	c (mm)	Lichtträger light guide Portador de luz
05301-01	130	19,5	12,0	10,5	05302-01
05301-02	150	20,5	13,0	10,5	05302-01
05301-03	170	26,0	15,5	13,5	05302-02
05301-04	170	28,5	18,5	15,0	05302-02
05301-05	170	31,5	21,5	19,0	05302-02

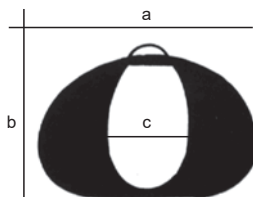

Nr.	L (mm)	a (mm)	b (mm)	c (mm)	Lichtträger light guide Portador de luz
05301-06	180	25,0	16,0	12,0 x 18,0	05302-02
05301-07	220	25,0	16,0	12,0 x 18,0	05302-03

Operations-Laryngoskope
Operation Laryngoscope
Laringoscopios operativo

05300-01

Bruststütze für Erwachsene, Set bestehend aus: 05300-03 / 05300-05 / 05300-06
Chest Support for adults, complete consisting of: 05300-03 / 05300-05 / 05300-06
Soporte pectoral para adultos, compuesto de: 05300-03 / 05300-05 / 05300-06

05300-02

Bruststütze für Kinder, Set bestehend aus: 05300-04 / 05300-05 / 05300-06
Chest Support for children, complete consisting of: 05300-04 / 05300-05 / 05300-06
Soporte pectoral para niños, compuesto de: 05300-04 / 05300-05 / 05300-06

05300-05
Gelenk
Joint
Articulacion



LEWY Bruststütze, für Operations-Laryngoskop
LEWY Chest Support, for Operation Laryngoscope
Soporte pectoral LEWY para laringoscopios operativo

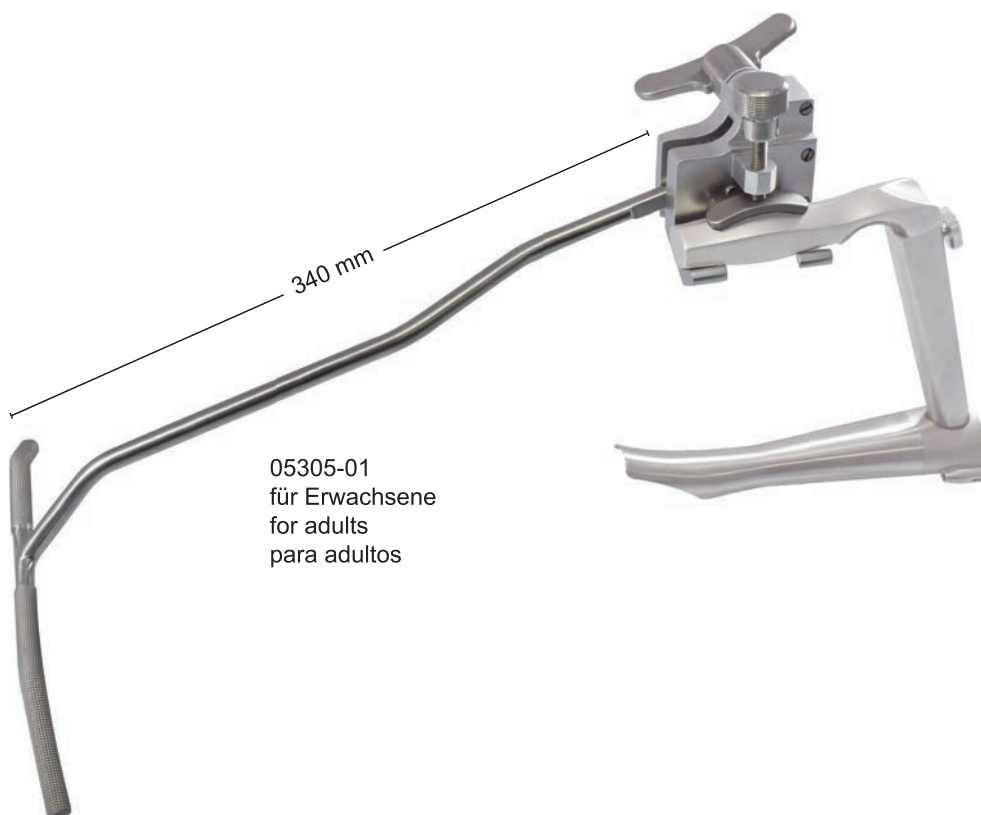

05305-01
für Erwachsene
for adults
para adultos

05305-02
Laryngoskope-Handgriff, abnehmbar
Laryngoscope Handle, detachable
Mango para laringoscopios, desmontable

Verwendung mit
use with
utilizar con



05305-01
LEWY Bruststütze für Operations-Laryngoskope
LEWY Chest Support for Operating Laryngoscope
Soporte pectoral LEWY para laringoscopios operativo

Fiberglas Lichtträger
Fiberglass Light Carriers
Portador de luz fría

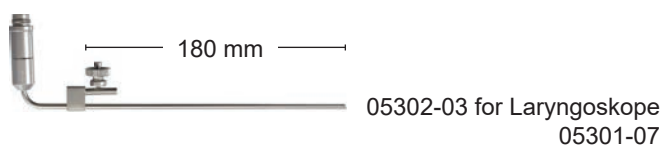
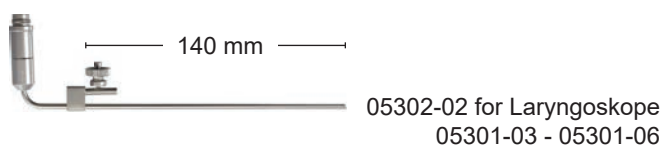
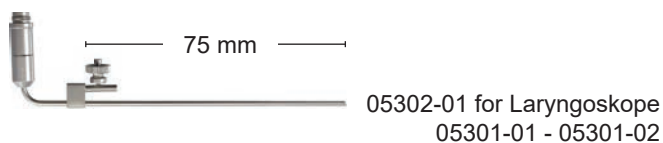

05303-01
Injektionskanüle für Laryngoskope: 05301-01 - 05301-07
Injection drain tube for Laryngoscopes: 05301-01 - 05301-07
Canúla de inyección para laringoscopios: 05301-01 - 05301-07



Unsere Fiberglas-Lichtträger werden mit allen Adaptern geliefert.
Our Fiberglass light carriers are supplied with all adapters.
Todos nuestros portadores de luz de fibra optica se suministran con todos los adaptadores.

Fiberglas Lichtträger
Fiberglass Light Carriers
Portador de luz fría



05303-10
Leuchtklammer
Light Clip
Grapa para iluminación

- | | |
|--|---------------------|
| 05304-01 | |
| Rauchabsaugrohr für Laryngoskope: | 05301-03 - 05301-07 |
| Suction tube for Laryngoscopes: | 05301-03 - 05301-07 |
| Canúla de succion para laringoscopios: | 05301-03 - 05301-07 |

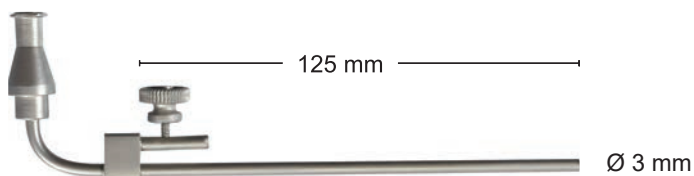

- | | |
|--|---------------------|
| 05304-02 | |
| Rauchabsaugrohr für Laryngoskope: | 05301-01 - 05301-02 |
| Suction tube for Laryngoscopes: | 05301-01 - 05301-02 |
| Canúla de succion para laringoscopios: | 05301-01 - 05301-02 |

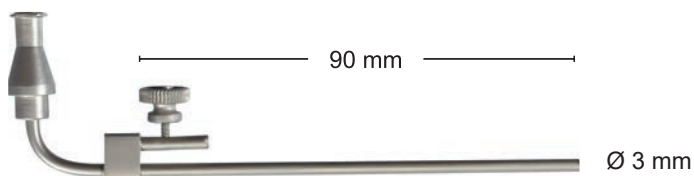

Unsere Fiberglas-Lichtträger werden mit allen Adaptern geliefert.
Our Fiberglass light carriers are supplied with all adapters.
Todos nuestros portadores de luz de fibra optica se suministran con todos los adaptadores.

Laryngoskope mit Fiberglass-Lichtträger
 Laryngoscopes with Fiberglass Light Carrier
 Laringoscopios con portador de luz de fibra óptica

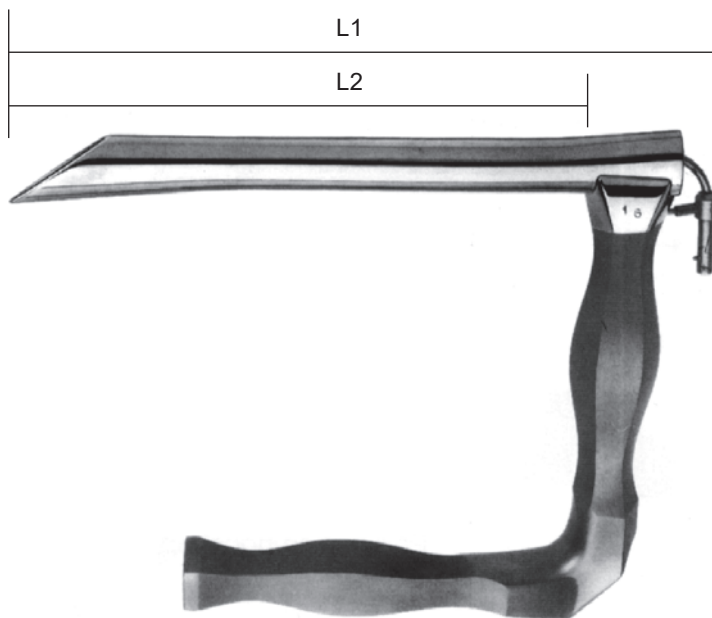

HOLINGER

Nr.	L1	L2	Lichtträger light guide Portador de luz
05310-01	180 mm	158 mm	05311-01
05310-02	170 mm	148 mm	05311-02
05310-03	120 mm	98 mm	05311-03
05310-04	90 mm	68 mm	05311-04



ACMI



WOLF



STORZ

Unsere Fiberglas-Lichtträger werden mit allen Adaptern geliefert.
 Our Fiberglass light carriers are supplied with all adapters.
 Todos nuestros portadores de luz de fibra óptica se suministran con todos los adaptadores.

Operations-Laryngoskope
 Operation Laryngoscopes
 Laringoscopios operativos



JACKSON

Nr.	L1	L2	Außen-Dm Outer-dm dm-exterior	Innen-Dm Inner-dm dm-interior	Lichtträger light guide Portador de luz
05320-01	180 mm	158 mm	17,0 mm	14,5 mm	05321-01
05320-02	170 mm	148 mm	14,5 mm	12,5 mm	05321-02
05320-03	120 mm	98 mm	14,0 mm	12,0 mm	05321-03
05320-04	90 mm	68 mm	13,0 mm	10,5 mm	05321-04



ACMI



WOLF



STORZ

Unsere Fiberglas-Lichtträger werden mit allen Adaptern geliefert.
 Our Fiberglass light carriers are supplied with all adapters.
 Todos nuestros portadores de luz de fibra optica se suministran con todos los adaptadores.

Operations-Laryngoskope
Operation Laryngoscopes
Laringoscopios operativos



spreizbar
spreadable
desplegable

Nr.	L (mm)	a (mm)	b (mm)	c (mm)	Lichtträger light guide Portador de luz
05322-01	130	19,5	12,0	10,5	05302-01
05322-02	150	20,5	13,0	10,5	05302-01
05322-03	170	26,0	15,5	13,5	05302-02
05322-04	170	28,5	18,5	15,0	05302-02
05322-05	170	31,5	21,5	19,0	05302-02
05322-06	180	25,0	16,0	12,0 x 18,0	05302-02
05322-07	220	25,0	16,0	12,0 x 18,0	05302-03



05303-10
Leuchtklammer
Light Clip
Grapa para iluminación

Kehlkopf Polypenzangen
Laryngeal Polypus Forceps
Pinzas para pólipos laringeales

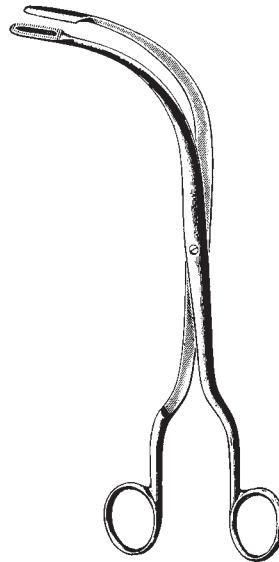

FRAENKEL
53111-18
18 cm, 7"

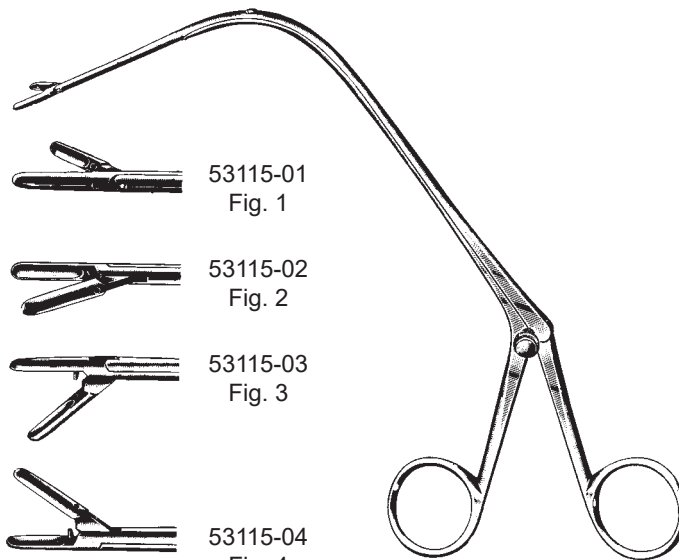

53115-01
Fig. 1
53115-02
Fig. 2
53115-03
Fig. 3
53115-04
Fig. 4

JURASZ
23 cm, 9"

Kehlkopfschere, Kehlkopfpinzette, Kehldeckelhalter
Laryngeal Scissors, Laryngeal Forceps, Epiglottis Retractor
Tijera laringeal, Pinza laringeal, Depresor para epiglottis



KILLIAN
53102-20
20 cm, 8"

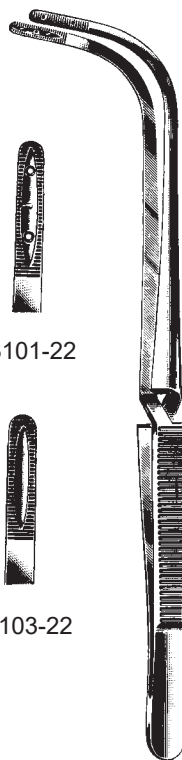

53101-22

53103-22

JACKSON
22 cm, 8 3/4"

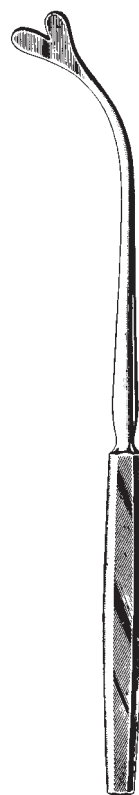

REICHERT
53121-24
24 cm, 9 1/2"

Kehlkopfkanülen, Tonsillenspritzen
 Laryngeal Cannulas, Tonsil Syringes
 Cánulas laringeales, Jeringas



51291-00
 2,5 mm Ø

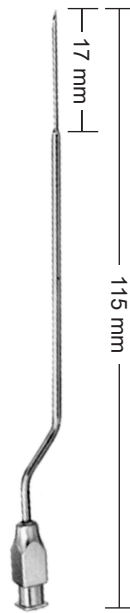

51293-00
 0,8 mm Ø

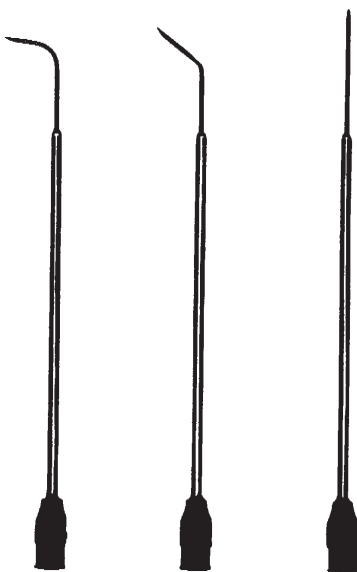

51293-90
 90°

51293-45
 45°

51292-00

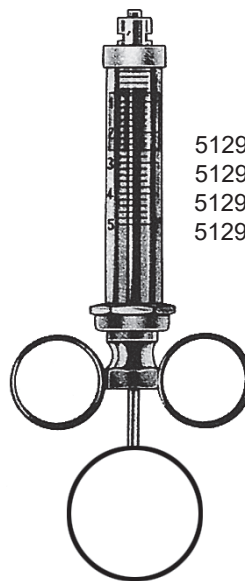

51290-02 2 ml
 51290-05 5 ml
 51290-10 10 ml
 51290-20 20 ml

Kehlkopfspiegel
Laryngeal Mirrors
Espejos laringeales

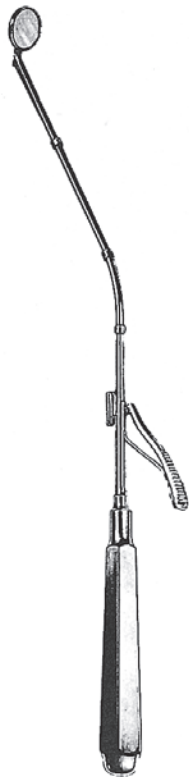

MICHEL
25 cm, 10"



47139-12
12 mm



47139-14
14 mm



47139-16
16 mm



47139-18
18 mm

Kehlkopfspiegel und -griffe
 Laryngeal Mirrors and Handles
 Espejos y mangos laringeales

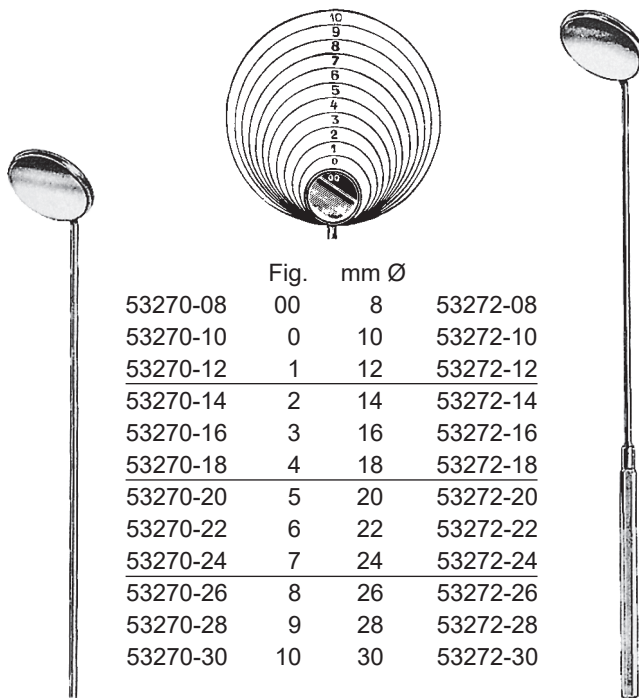

	Fig.	mm Ø	
53270-08	00	8	53272-08
53270-10	0	10	53272-10
53270-12	1	12	53272-12
53270-14	2	14	53272-14
53270-16	3	16	53272-16
53270-18	4	18	53272-18
53270-20	5	20	53272-20
53270-22	6	22	53272-22
53270-24	7	24	53272-24
53270-26	8	26	53272-26
53270-28	9	28	53272-28
53270-30	10	30	53272-30

53270-08 - 53270-30

53272-08 - 53272-30



53274-12



53276-10

Kehlkopf watteträger
Laryngeal Cotton Carriers
Porta-algodones laringeales

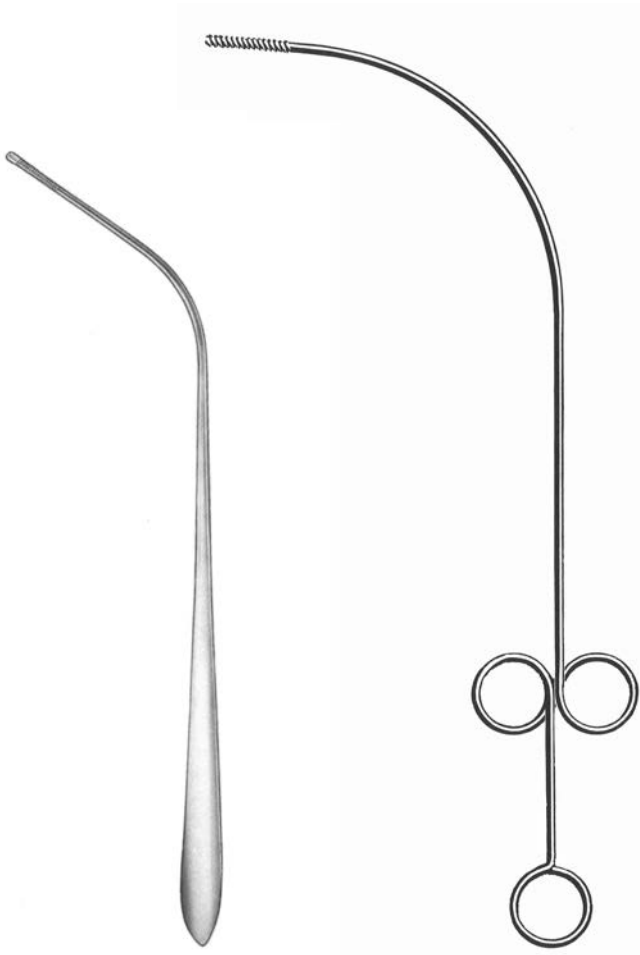

KILLIAN
21350-25
25 cm, 10"

FEIN
21360-26
26 cm, 10 ¼"

21370-25
Ø 2,5 mm

Saugrohre
Suction Tubes
Tubos de aspiración

Koagulations-Saugrohr, gerade
Coagulation Suction Tube, straight
Tubo de succion y coagulación, recto

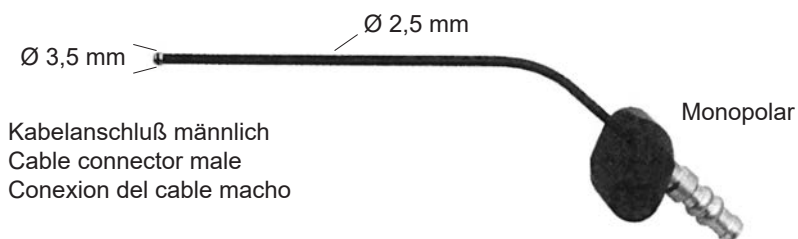

41312-10 Nutzlänge 10 cm, 4"
Working length 10 cm, 4"
Largo útil 10 cm, 4"

41312-26 Nutzlänge 26 cm, 10 ¼"
Working length 26 cm, 10 ¼"
Largo útil 26 cm, 10 ¼"

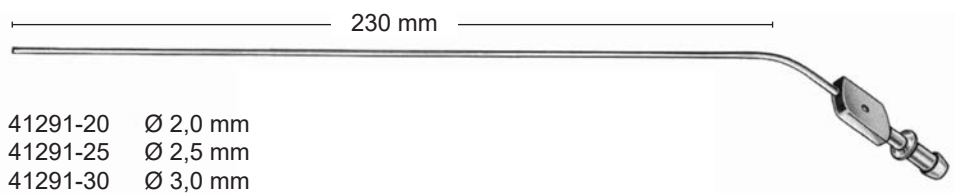

41291-20 Ø 2,0 mm

41291-25 Ø 2,5 mm

41291-30 Ø 3,0 mm



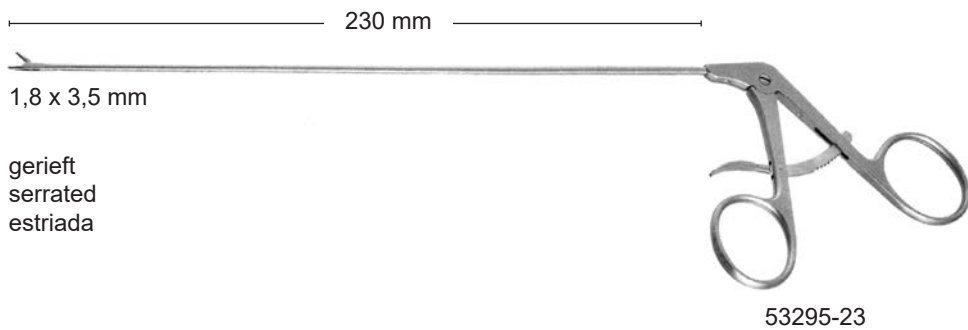
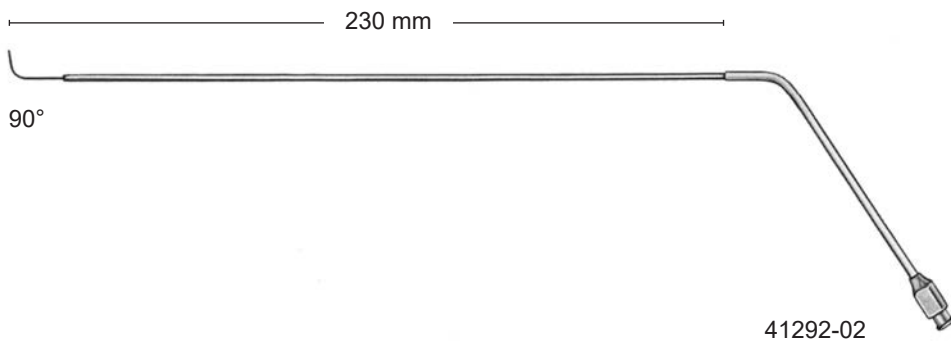
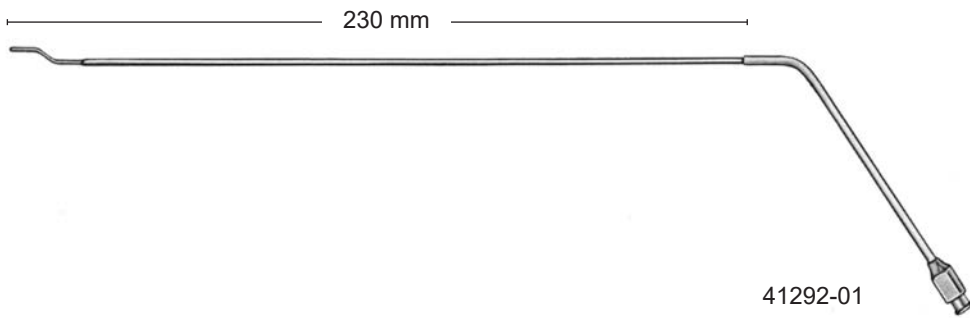

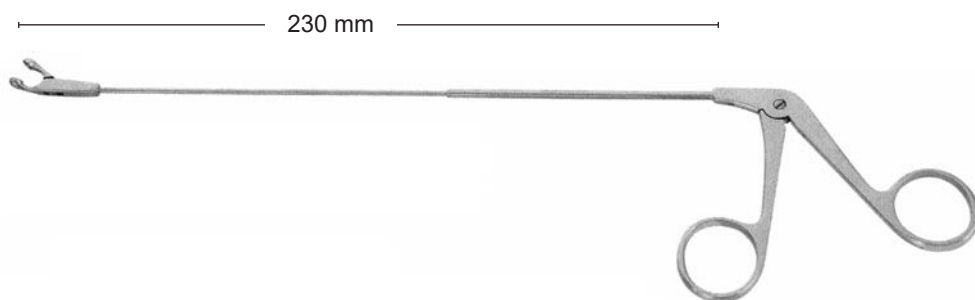

Injektionskanüle, Luer-Lock, Nadelhalter
Injection Needle, Luer-Lock, Needle Holder
Canula de inyeccion, conexion Luer-Lock, Porta-aguja



Mikro Rohrschaftzangen
 Micro Laryngeal Forceps
 Micro pinzas con vaina tubular



Mikro-Fasszängchen
 Micro Grasping Forceps
 Micro pinzas de agarre





	gerade, gerieft straight, serrated recta, estriada	53280-01 1,5 x 10 mm
	nach links gebogen, gerieft curved to left, serrated curvada hacia la izquierda, estriada	53280-02 1,5 x 8,5 mm
	nach rechts gebogen, gerieft curved to right, serrated curvada hacia la derecha, estriada	53280-03 1,5 x 8,5 mm
	aufgebogen, gerieft curved up, serrated curvada hacia arriba, estriada	53280-16
	dreieckig, gerieft, nach rechts aufgebogen triangular, serrated, curved to right triangulada, estriada, curvada hacia la derecha	53280-17
	dreieckig, gerieft, nach links aufgebogen triangular, serrated, curved to left triangulada, estriada, curvada hacia la izquierda	53280-18

Mikro Rohrschaftzangen
 Micro Laryngeal Forceps
 Micro pinzas con vaina tubular

Mikro-Löffelzangen

Micro Cup Shaped Forceps





Micro pinzas en forma cucharilla

		Ø 2 mm	Ø 4 mm
	gerade straight recta	53280-04	53280-19
	nach links gebogen curved to left curvada hacia la izquierda	53280-05	53280-20
	nach rechts gebogen curved to right curvada hacia la derecha	53280-06	53280-21
	aufgebogen curved up curvada hacia arriba	53280-07	53280-22

Mikro-Scheren

Micro Scissors

Micro tijeras

	gerade straight recta		53280-08
	nach links gebogen curved to left curvada hacia la izquierda		53280-09
	nach rechts gebogen curved to right curvada hacia la derecha		53280-10
	gerade horizontal straight horizontal recta horizontal		53280-11
	aufgebogen 45° curved up 45° curvada hacia arriba en 45°		53280-12

Instrumente für Laryngoskopie
 Instruments for Laryngology
 Instrumentos para laringoscopia

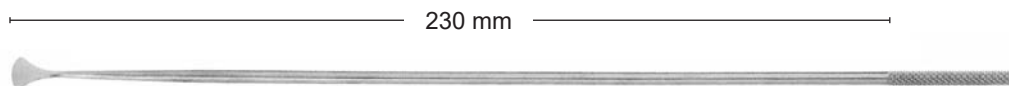



	Messer, sichelförmig, gebogen, spitz Knife, sickle shaped, curved, pointed Cuchillo en forma de hoz, agudo, curvo	53290-01
---	---	----------

	Messer, oval, gerade Knife, oval, straight Cuchillo, recto, ovalado	53290-02
---	---	----------

	Messer, Rundschnittform, vertikal schneidend Knife, round, cuts vertically Cuchillo, corte redondo, corte vertical	53290-03
---	--	----------

	Messer, oval 45°, 2,5mm Knife, oval 45°, 2,5 mm Cuchillo, ovalado en 45°, 2,5mm	53290-04
---	---	----------

	Häkchen, stumpf 90°, mit Sondenknopf Hook, blunt angled 90° with probe end Ganchito, romo en 90°, abotonado	53290-05
---	---	----------

	Häkchen, stumpf, mit Sondenknopf Hook, blunt with probe end Ganchito, romo, abotonado	53290-06
---	---	----------

	Knotenführer Knot tier Baja nudos	53290-07
---	---	----------

Instrumente für Laryngoskopie
 Instruments for Laryngology
 Instrumentos para laringoscopia

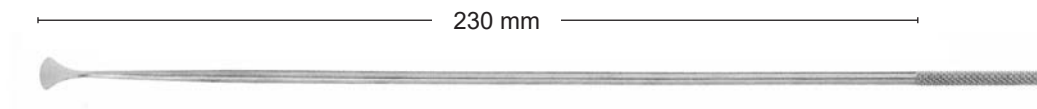



	Messer, gerader Schnitt, spitz Knife, straight cut, pointed Cuchillo, corte recto, agudo	53290-11
---	--	----------

	Messer, golfstockförmig, gebogen, rund Knife, golf stick shaped, curved round Cuchillo en forma de golf, curvo, redondo	53290-12
---	---	----------

	Häkchen, scharf Hook, sharp Ganchito, agudo	53290-13
---	---	----------

	Umstechungsnadel, nach links gebogen Needle, curved to left Aguja, curvada hacia la izquierda	53290-14
---	---	----------

	Umstechungsnadel, nach rechts gebogen Needle, curved to right Aguja, curvada hacia la derecha	53290-15
---	---	----------

	Saugraspatorium Suction Elevator Legra de succion	53290-16
---	---	----------



53290-08
 Handgriff für Stabinstrumente
 Handle for microlaryngeal instruments
 Mango para instrumentos microlaringeos

Universalgriffe, Verlängerungsrohre, Aufsätze
 Universal Handles, Interchangeable Tips, Tubes
 Mangos universales, Tubos de extension, Puntas



BRUENINGS
 53131-20
 20 cm, 8"



BRUENINGS

- | | | | |
|----------|----------------|----------|----------------|
| 53132-20 | 20 cm, 8" | 53132-50 | 50 cm, 19 3/4" |
| 53132-30 | 30 cm, 11 3/4" | 53132-60 | 60 cm, 23 1/2" |
| 53132-40 | 40 cm, 15 3/4" | | |

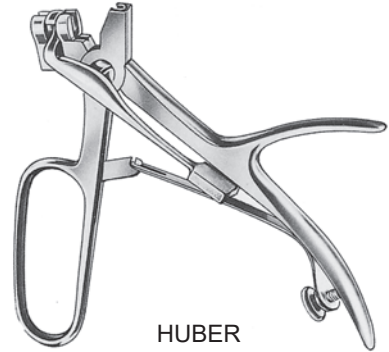

HUBER
 53130-00



FRAENKEL
 53150-00



SEIFERT
 53152-00



FRAENKEL
 53154-00



SCHEINMANN
 53155-00



SCHEINMANN
 53157-00



53158-02



53158-03



BRUENINGS
 53158-02 - 53158-03



53160-02



53160-03



BRUENINGS
 53160-02 - 53160-03



LANGE
 53162-00



53164-01



53164-02



KRAUSE
 53164-01 - 53164-02



KRAUSE
 53166-00



SCHUMACHER
 53170-00



BARACANI
 53175-00



53177-01



53177-02



CORDES
 53177-01 - 53177-02

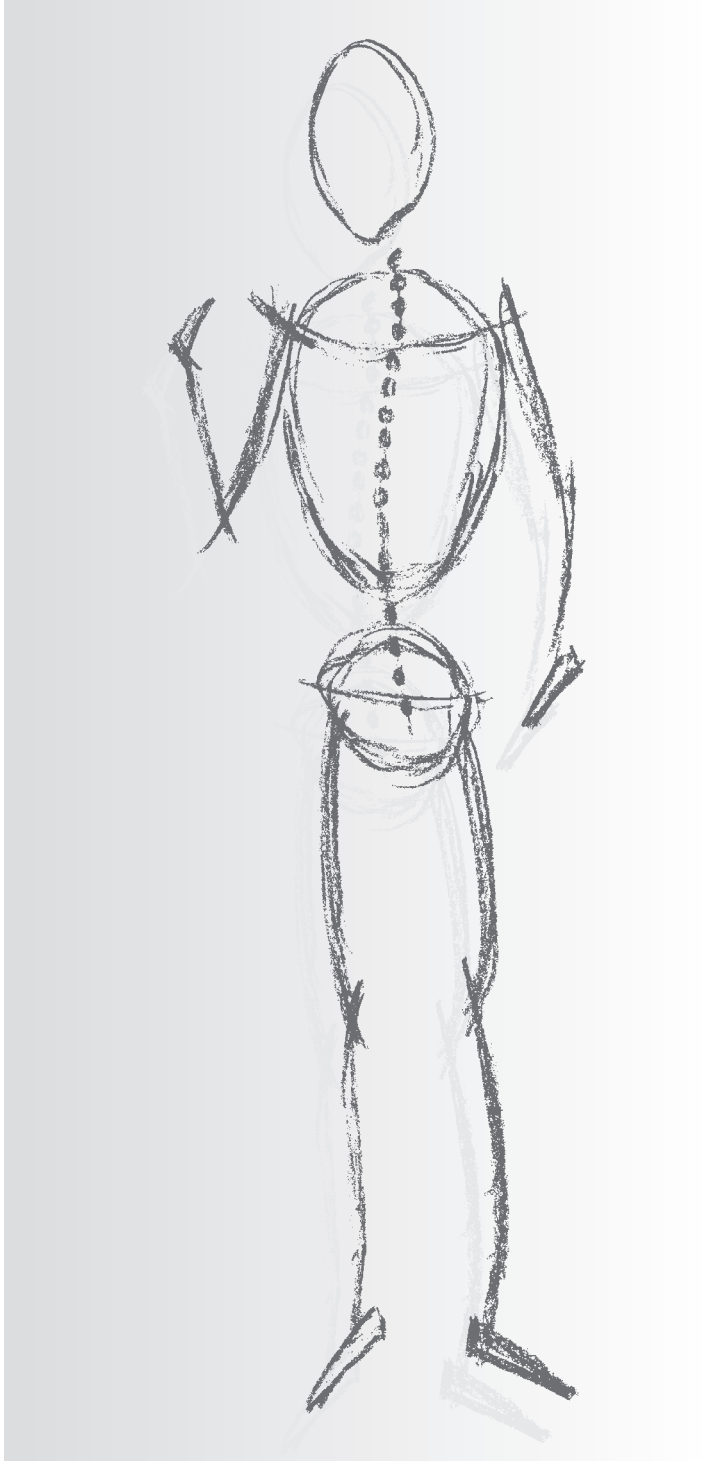

Reda Instrumente GmbH
Gänsäcker 34 - P.O. Box 131
D-78532 Tuttlingen

BRONCHOSKOPIE

BRONCHOSCOPY

BRONCOSCOPIA

Indikationen und Kontraindikationen finden Sie in der entsprechenden Gebrauchsanweisung!
Indication and Contraindication please refer to our user's manual!
Indicaciones y Contraindicaciones se encuentran en la instrucciones de uso correspondientes!

Broncho-Oesophagoskopiezangen
 Broncho-Esophagoscopy Forceps
 Pinzas para bronco-esofagoscopia

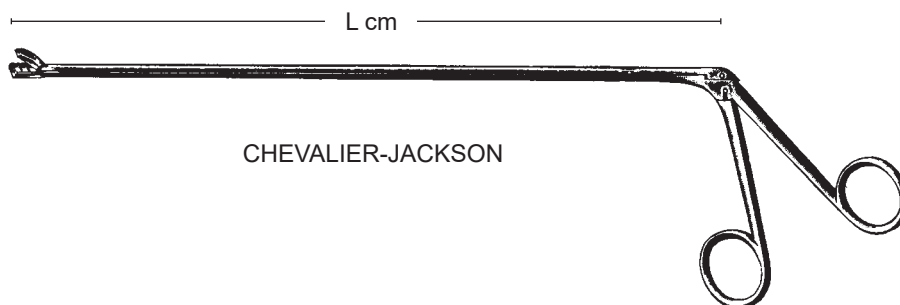

CHEVALIER-JACKSON

Ø 4 mm



Fig. 1



Fig. 2



Fig. 3



Fig. 4

30 cm / 11 3/4"
 40 cm / 15 3/4"
 50 cm / 19 3/4"
 60 cm / 23 1/2"

53230-01
 53240-01
 53250-01
 53260-01

53230-02
 53240-02
 53250-02
 53260-02

53230-03
 53240-03
 53250-03
 53260-03

53230-04
 53240-04
 53250-04
 53260-04



Fig. 5



Fig. 6



Fig. 7



Fig. 8

30 cm / 11 3/4"
 40 cm / 15 3/4"
 50 cm / 19 3/4"
 60 cm / 23 1/2"

53230-05
 53240-05
 53250-05
 53260-05

53230-06
 53240-06
 53250-06
 53260-06

53230-07
 53240-07
 53250-07
 53260-07

53230-08
 53240-08
 53250-08
 53260-08

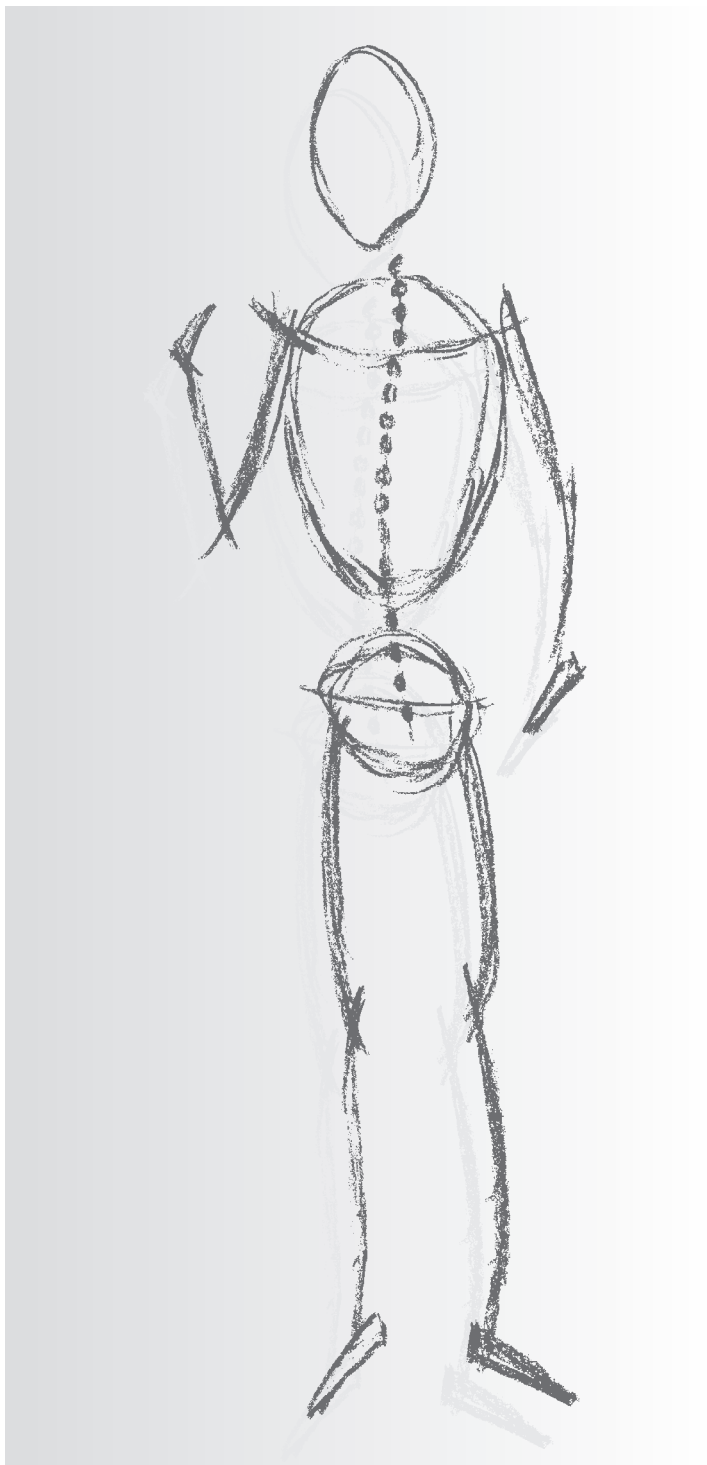

Reda Instrumente GmbH
Gänsäcker 34 - P.O. Box 131
D-78532 Tuttlingen

SÄTZE

SET

SET

SET/440:	Grundsieb HNO / Basic set for ENT / Juego basico para ORL	
03180-90	ZIEGLER head mirror 90mm	1x1
45246-14	ear forceps, HARTMANN 14cm	1x1
45206-14	ear forceps bayonet, LUCAE 14cm, without teeth	1x1
65110-15	tissue forceps, ALLIS 4x5 teeth, 15cm	1x1
17170-25	swab forceps serrated, FOERSTER straight, 25cm	1x1
45010-00	ear specula set of 4, HARTMANN	1x1
09304-14	operating sciss.fine, JOSEPH straight, 14,0cm	1x1
09305-14	operating sciss.fine, JOSEPH curved, 14,5cm	1x1
25137-11	BABY WEBSTER Needle Holder 4 3/4 TC smooth	1x1
45110-00	ear curette, BUCK straight, blunt, Fig. 0	1x1
45110-01	ear curette, BUCK straight, blunt, Fig. 1	1x1
45097-10	ear syringe complete, REINER 100ml	1x1
45150-18	paracentesis needle, POLITZER bajonet, 18cm	1x1
41299-03	Suction Tube Baron 3Fr	1x1
41299-05	suction tubes Baron 5Fr.	1x1
41299-07	suction tube, BARON 7 Fr.	1x1
45180-02	ear loop, BILLEAU, Fig.2, 16cm	1x1
45190-01	ear hooklet small, DAY, Fig. 1, 16cm	1x1
47112-01	nasal speculum, MOD.VIENNA for babies	1x1
47112-02	nasal speculum, MOD.VIENNA for children	1x1
47112-03	nasal speculum, MOD.VIENNA for adults	1x1
49107-19	tongue depressor, BRUENINGS 19cm	2x1
49265-14	mouth gag, DOYEN-JANSEN (Molt) 14cm	1x1
45072-01	Tuning forks w. foot, A1-440	1x1
21272-14	cotton applicators, FARREL triangular, 14cm	1x1
45193-01	hooklet , LUCAE Fig. 1	1x1
45206-16	ear forceps bayonet, LUCAE without teeth, 16cm	1x1
45261-08	ear polypus forceps, HARTMANN 8,5cm	1x1
45271-08	ear forceps, STRUEMPEL D. 2,5 x 5mm, 8,5cm	1x1
11102-14	forceps dressing, 14,5cm	1x1
11120-14	forceps tissue 1x2 t. 14,5 cm	1x1
47351-26	nasal snare angled, KRAUSE 26cm	1x1
47355-03	loops 0,3 mm bundle of 12 ea.	1x1
47332-25	EICKEN (KILLIAN) antrum cannula 2.5mm	1x1
43614-00	BOWMAN lachrymal probe, Fig. 00/0, 0,7/0,8mm Ø	1x1
43614-12	BOWMAN lachrymal probe, Fig. 1/2, D. 0,9/1,1mm	1x1
07103-00	scalpel handle no. 3 12,5cm	1x1
89142-02	jar 50 x 100mm	1x1
53272-10	laryngeal mirror with handle Fig. 0, D. 10mm	5x1
53272-12	laryngeal mirror with handle Fig. 1, D. 12mm	5x1
53272-16	laryngeal mirror with handle Fig. 3, D. 16mm	3x1
53272-18	laryngeal mirror with handle Fig. 4, D. 18mm	3x1
51290-02	tonsil syringe 3 rings LL 2ml	1x1
51292-00	tonsil injection needle straight	1x1
45097-10	ear syringe complete, REINER 100ml	1x1
89139-25	Kidney bowl medium 250 x 140 x 40mm	1x1

SET/443:	Myringotomie Set / Myringotomie Set / Juego para miringotomia	
45010-55	ear specula, HARTMANN D. 5,5mm	1x1
45010-65	ear specula, HARTMANN D. 6,5mm	1x1
45010-75	ear specula, HARTMANN D. 7,5mm	1x1
45350-70	ear forceps micro serrated 7mm x 8cm	1x1
45110-01	ear curette, BUCK straight, blunt, Fig. 1	1x1
45165-17	ear knife, SEXTON angled, 17cm	1x1
45151-16	paracentesis needle, POLITZER angled, 16,5cm	1x1
45713-15	needle, BARBARA curved pointed	1x1
45724-10	hooklet, BARBARA 90° angled, 1,0mm	1x1
45180-02	ear loop, BILLEAU, Fig.2, 16cm	1x1
45192-02	hooklet , WAGENER Fig. 2, 14cm	1x1
21272-14	cotton applicators, FARREL triangular, 14cm	1x1
41305-07	suction tubes, ROSEN D. 0,7mm	1x1
41305-09	suction tubes, ROSEN D. 0,9mm	1x1
41305-12	suction tubes, ROSEN D. 1,2mm	1x1
41307-00	WULLSTEIN suction handle for Rosen cann.	1x1
45206-14	ear forceps bayonet, LUCAE 14cm, without teeth	1x1
45246-12	ear forceps, HARTMANN, 12cm	1x1
45255-08	ear polypus forceps, WULLSTEIN 8,5cm	1x1

SET/441:	Set für Mastoidektomie / Mastoidectomy Set / Juego para mastoidectomia	
07103-00	scalpel handle no. 3 12,5cm	1x1
47102-02	nasal speculum, HARTMANN-HALLE Fig. 2	1x1
19670-16	retractor, WEITLANER sharp, 16,5cm	1x1
19670-14	retractor, WEITLANER sharp, 14,0cm	1x1
19654-13	retractor, WEITLANER-WULLSTEIN sharp, 13cm	1x1
19280-03	retractor, VOLKMANN pointed, 21,5cm, 3 teeth	2x1
19312-02	retractor, LANGENBECK 21cm, 30x14mm	2x1
33702-15	periosteal elevator, FARABEUUF straight, 15cm, 12,5mm	1x1
45807-20	elevator, LEMPERS 20.5cm	1x1
47415-18	FREER septum elevator, 18cm double ended, sharp/blunt	1x1
33605-04	gouge 13,5cm, 4mm	1x1
33605-06	gouge 13.5cm x 6mm	1x1
33605-08	gouge 13,5cm, 8mm	1x1
33602-04	osteotome 13,5cm, 4mm	1x1
33602-06	osteotome 13,5cm, 6mm	1x1
33602-08	osteotome 13,5cm, 8mm	1x1
33700-05	hammer, COTTLE flat/convex D. 30mm, 240gr., 18cm	1x1
47303-03	punch, KERRISON 17cm, shaft 85mm, 3x3mm	1x1
33156-18	bone rongeur, BEYER 18cm	1x1
45760-01	curette, HOUSE 1,0 / 1,2mm	1x1
33490-20	bone curette, LEMPERS 17,5cm, Fig. 00	1x1
33475-00	bone curette, SPRATT 17cm, Fig. 0	1x1
33475-01	bone curette, SPRATT 17cm, Fig. 1	1x1
13221-12	hemost.fcps.,HALSTED-MOSQUITO curved, 12,0cm	4x1
13310-14	hemost.fcps. ,ROCHESTER-PEAN straight, 14cm	4x1
13311-14	hemost.fcps. ,ROCHESTER-PEAN curved,14cm	4x1
13320-14	hemost.fcps.,ROCHESTER-OCHSNER 1x2 teeth, straight, 14cm	2x1
65110-15	tissue forceps, ALLIS 4x5 teeth, 15cm	2x1
11170-12	forceps dressing serr., ADSON 12cm	1x1
11180-12	forceps tissue 1x2 t.,ADSON 12cm	1x1
11188-12	forceps tissue, ADSON-BROWN 7x7 teeth, 12cm	1x1
11102-14	forceps dressing, 14,5cm	1x1
11120-14	forceps tissue 1x2 t. 14,5 cm	1x1
21320-18	cotton applicator, JOBSON-HORNE 18cm	1x1
09341-10	operating sciss.fine, IRIS curved, 10cm	1x1
09363-11	scissors, STEVENS blunt/blunt, curved 11cm	1x1
09305-14	operating sciss.fine, JOSEPH curved, 14,5cm	1x1
09283-15	diss.scissors,METZENBAUM-FINO curved, 15cm	1x1
09110-14	operating scissors, STANDARD pointed/blunt, straight 14,5cm	1x1
41299-03	Suction Tube Baron 3Fr	1x1
41299-05	suction tubes Baron 5Fr.	1x1
41299-07	suction tube, BARON 7 Fr.	1x1
41295-06	suction tube, FRAZIER/FERGUSSON 19cm, 30°, Charr. 6	1x1
41295-08	suction tube, FRAZIER/FERGUSSON 19cm, 30°, Charr. 8	1x1
41295-10	suction tube, FRAZIER/FERGUSSON 19cm, 30°, Charr. 10	1x1
41307-00	WULLSTEIN suction handle for Rosen cann.	1x1
41305-05	suction tubes, ROSEN D. 0,5mm	2x1

41305-08	Rosen Suction Tube 0,8mm	2x1
41305-09	suction tubes, ROSEN D. 0,9mm	2x1
41305-12	suction tubes, ROSEN D. 1,2mm	2x1
25144-13	needle holder, HALSEY serrated, TC, 13cm	1x1
25164-15	needle holder, CRILE-WOOD serrated, TC, 15cm	1x1
15111-09	towel forceps, BACKHAUS 9cm	6x1
17110-20	dressing forceps, GROSS-MAIER straight, 20cm	1x1
89127-08	Bowl round, stainless steel 80 x 40mm, 0,14 l. (5,6 OZ)	1x1
89127-06	round bowl 61x30mm, 0.07 ltr	1x1

SET/442:	Set für Mikrochirurgie (Ohr) / Set for Ear Micro Surgery / Juego para micro otologia	
47103-03	nasal specula HARTMANN Fig. 3	1x1
45803-16	elevator, LEMPERT curved, 16cm, 2mm	1x1
33718-16	periosteal elevator, JOSEPH 16cm, 4mm	1x1
11120-11	forceps tissue 1x2 t. 11,5 cm	1x1
11260-15	forceps dressing, SEMKEN 15,5cm	1x1
09141-14	dissecting scissors, DEAVER pointed/blunt, curved, 14,5cm	1x1
19677-13	Plester retractor, 13cm 2x2t., sharp	2x1
19673-11	retractor, PLESTER blunt, 11cm	1x1
19672-11	retractor, PLESTER blunt, 11cm	1x1
19283-01	WILLIGER, wound retractor, 12cm 3 teeth, sharp, straight	1x1
07103-00	scalpel handle no. 3 12,5cm	2x1
09111-14	operating scissors, STANDARD pointed/blunt, curved, 14,5cm	1x1
13310-14	hemost.fcps. , ROCHESTER-PEAN straight, 14cm	1x1
25129-13	needle holder, WEBSTER TC smooth, 13cm	1x1
13220-12	hemost.fcps., HALSTED-MOSQUITO straight, 12,5cm	1x1
13221-12	hemost.fcps., HALSTED-MOSQUITO curved, 12,0cm	2x1
15111-09	towel forceps, BACKHAUS 9cm	6x1
09340-10	operating sciss.fine, IRIS straight, 10cm	1x1
R065-040125-003	Bipolar connecting cable 3 mtr. long for Erbe / Storz HF-generators european flat plug f. instruments	1x1
45010-55	ear specula, HARTMANN D. 5,5mm	1x1
45010-65	ear specula, HARTMANN D. 6,5mm	1x1
45010-75	ear specula, HARTMANN D. 7,5mm	1x1
45350-70	ear forceps micro serrated 7mm x 8cm	1x1
45255-08	ear polypus forceps, WULLSTEIN 8,5cm	1x1
45261-08	ear polypus forceps, HARTMANN 8,5cm	1x1
45362-45	ear fcps.micro spoon oval 4,5mm, straight	1x1
45267-20	ear polypus forceps, HARTMANN D. 2,0mm, 8,5cm	1x1
45310-40	ear scissors micro, BELLUCCI micro mini, 4mm	1x1
45387-01	DIETER, malleurs punches upwards cutting, Ø 1,8mm, 8cm	1x1
45371-40	McGEE, wire bending forceps 0,8 x 4,0mm, 8cm	1x1
41305-10	suction tubes, ROSEN D. 1,0mm	4x1
41305-07	suction tubes, ROSEN D. 0,7mm	4x1
41305-12	suction tubes, ROSEN D. 1,2mm	4x1
41305-15	suction tubes, ROSEN D. 1,5mm	4x1
41305-20	suction tubes, ROSEN D. 2,0mm	4x1
41307-00	WULLSTEIN suction handle for Rosen cann.	1x1
41304-06	suction tubes, PLESTER 30°, Charr.6	1x1
41304-08	suction tubes, PLESTER 30°, Charr.8	1x1
41304-10	suction tubes, PLESTER 30°, Charr.10	1x1
45190-02	ear hooklet medium, DAY, Fig. 2, 16cm	1x1
45192-03	hooklet , WAGENER Fig. 3, 14cm	1x1
45111-00	ear curette Buck straight, sharp, Fig. 00	1x1
45112-00	ear curette Buck straight, sharp, Fig. 0	1x1
45748-16	hook, reverse cutting, 0,6mm/16cm	1x1
45760-01	curette, HOUSE 1,0 / 1,2mm	2x1

45760-02	curette, HOUSE 1,5 / 1,8mm	2x1
45749-16	PLESTER, footplate hook, 16cm 90° angled, oval-blunt	1x1
45722-06	hooklet, BARBARA 45° angled, 0,6mm	1x1
45724-03	hooklet, BARBARA 90° angled, 0,3mm	2x1
45724-06	hooklet, BARBARA 90° angled, 0,6mm	2x1
45771-16	fork PLESTER, 16cm, width 0,6mm	1x1
45722-10	hooklet, BARBARA 45° angled, 1,0mm	1x1
45706-35	Round knife, PLESTER 15,5cm, size 3,5mm	2x1
45709-20	knife circular, ROSEN 2mm	2x1
45704-15	sickle knife, WULLSTEIN 15,5cm	2x1
45713-15	needle, BARBARA curved pointed	2x1
45724-10	hooklet, BARBARA 90° angled, 1,0mm	1x1
91127-16	bipolar forceps angled 1mm, 16,5cm	1x1
89127-08	Bowl round, stainless steel 80 x 40mm, 0,14 l. (5,6 OZ)	1x1

SET/444:	Set für Ohrmuschel - Operation / Set for Otoplasty Surgery / Juego para cirugía otoplastica	
07103-00	scalpel handle no. 3 12,5cm	1x1
09341-10	operating sciss.fine, IRIS curved, 10cm	1x1
09305-14	operating sciss.fine, JOSEPH curved, 14,5cm	1x1
09358-11	Cottle bulldog-scissors cvd., 11,5cm	1x1
09111-14	operating scissors, STANDARD pointed/blunt, curved, 14,5cm	1x1
11130-11	Tissue Fcps 1x2 teeth 11cm fine	1x1
11188-12	forceps tissue, ADSON-BROWN 7x7 teeth, 12cm	1x1
11102-14	forceps dressing, 14,5cm	1x1
11120-14	forceps tissue 1x2 t. 14,5 cm	1x1
21272-14	cotton applicators, FARREL triangular, 14cm	1x1
47530-01	DINGMAN nasal rasp 15cm, left # 1	1x1
47530-02	DINGMAN nasal rasp 15cm right # 2	1x1
47380-15	nasal plastic knife, COTTLE 15cm	1x1
47415-18	FREER septum elevator, 18cm double ended, sharp/blunt	1x1
47451-04	septum chisel, FREER 4mm, curved	1x1
47562-18	hooklet delicate, GILLIES 18cm Fig. 2	1x1
19216-05	hooklet sharp 2 prong, JOSEPH 5mm, 16cm	1x1
19221-02	retractor (trach.) blunt 2 prongs, 16cm	1x1
89148-25	medicine cup 25 CC	1x1
51290-05	tonsil syringe 3 ring LL 5ml	1x1
41295-10	suction tube, FRAZIER/FERGUSSON 19cm, 30°, Charr. 10	1x1
41295-08	suction tube, FRAZIER/FERGUSSON 19cm, 30°, Charr. 8	1x1
13221-12	hemost.fcps., HALSTED-MOSQUITO curved, 12,0cm	6x1
13240-14	hemost.fcps. , KELLY straight, 14cm	1x1
11190-10	forceps, GRAEFE 10,5cm	1x1
43810-10	GRAEFE iris forceps, anatomic, straight, 10cm	1x1
13310-14	hemost.fcps. , ROCHESTER-PEAN straight, 14cm	1x1
15111-09	towel forceps, BACKHAUS 9cm	6x1
25144-13	needle holder, HALSEY serrated, TC, 13cm	1x1
91122-16	bipolar forceps pointed straight, 16,5cm total long	1x1
R065-040125-005	Bipolar connecting cable 5mtr. long for Erbe / Storz HF-generators european plug for instruments	1x1

SET/445:	Satz zur Mittelohr-Chirurgie, Tympanoplastik und Stapedektomie / Set for tympanic and stapedectomy / Juego para cirugía de timpano y estapedectomía	
19654-13	retractor, WEITLANER-WULLSTEIN sharp, 13cm	1x1
19672-11	retractor, PLESTER blunt, 11cm	1x1
19673-11	retractor, PLESTER blunt, 11cm	1x1
19677-13	Plester retractor, 13cm 2x2t., sharp	1x1
47120-50	Nasal speculum, KILLIAN 50mm	1x1
45010-55	ear specula, HARTMANN D. 5,5mm	1x1
07103-00	scalpel handle no. 3 12,5cm	1x1
07109-15	scalpel handle MINI 15,5cm	1x1
47451-04	septum chisel, FREER 4mm, curved	1x1
45802-16	elevator, LEMPERS straight, 16cm, 2mm	1x1
41305-12	suction tubes, ROSEN D. 1,2mm	1x1
41305-15	suction tubes, ROSEN D. 1,5mm	1x1
41305-20	suction tubes, ROSEN D. 2,0mm	1x1
41307-00	WULLSTEIN suction handle for Rosen cann.	1x1
45709-10	knife circular, ROSEN 1.0mm	1x1
45724-06	hooklet, BARBARA 90° angled, 0,6mm	1x1
45724-10	hooklet, BARBARA 90° angled, 1,0mm	1x1
45724-15	hooklet, BARBARA 90° angled, 1,5mm	1x1
45724-25	hooklet, BARBARA 90° angled, 2,5mm	1x1
45766-40	Micro Measuring Rod, HOUSE 4.0mm	1x1
45766-50	Micro Measuring Rod, HOUSE 5.0mm	1x1
11120-11	forceps tissue 1x2 t. 11,5 cm	1x1
11120-14	forceps tissue 1x2 t. 14,5 cm	1x1
11405-05	forceps, jeweller Fig. 5 11cm, 0.15mm	1x1
11170-12	forceps dressing serr., ADSON 12cm	1x1
09285-12	dissecting sciss., METZENBAUM curved, TC 12,0cm	1x1
09340-10	operating sciss.fine, IRIS straight, 10cm	1x1
09358-11	Cottle bulldog-scissors cvd., 11,5cm	1x1
09111-14	operating scissors, STANDARD pointed/blunt, curved, 14,5cm	1x1
13221-12	hemost.fcps., HALSTED-MOSQUITO curved, 12,0cm	1x1
25164-15	needle holder, CRILE-WOOD serrated, TC, 15cm	1x1
45706-35	Round knife, PLESTER 15,5cm, size 3,5mm	1x1
45722-10	hooklet, BARBARA 45° angled, 1,0mm	1x1
45757-16	dissector, FISCH right, 16cm	1x1
45755-16	dissector, FISCH left, 16cm	1x1
45704-15	sickle knife, WULLSTEIN 15,5cm	1x1
45724-03	hooklet, BARBARA 90° angled, 0,3mm	1x1
45724-06	hooklet, BARBARA 90° angled, 0,6mm	1x1
45724-10	hooklet, BARBARA 90° angled, 1,0mm	1x1
21108-14	probe myrtle leaf 14,5 cm	1x1
45371-40	McGEE, wire bending forceps 0,8 x 4,0mm, 8cm	1x1
45362-45	ear fcps.micro spoon oval 4,5mm, straight	1x1
45267-20	ear polypus forceps, HARTMANN D. 2,0mm, 8,5cm	1x1
45255-08	ear polypus forceps, WULLSTEIN 8,5cm	1x1
45310-40	ear scissors micro, BELLUCCI micro mini, 4mm	1x1
45315-55	ear scissors micro, BELLUCCI micro stanard, 5,5mm, curved right	1x1
45317-55	ear scissors micro, BELLUCCI micro standard, 5,5mm, curved left	1x1
45324-03	FISCH, ear scissors, cvd. right 3,0x0,75x2,0mm, 8cm	1x1
45325-03	FISCH, ear scissors, cvd. left 3,0x0,75x2,0mm, 8cm	1x1

SET/450:	Nasenseptumsatz / Nasal Septum set / Juego para el septo nasal	
47102-03	nasal speculum, HARTMANN-HALLE Fig. 3	1x1
47120-50	Nasal speculum, KILLIAN 50mm	1x1
47120-75	nasal speculum, KILLIAN 75mm	1x1
47120-90	nasal speculum, KILLIAN 90mm	1x1
09341-11	operating sciss.fine, IRIS curved, 11cm	1x1
09305-14	operating sciss.fine, JOSEPH curved, 14,5cm	1x1
09350-10	Graefe scissors, 10cm fine pattern	1x1
47223-01	WEIL-BLAKESLEY nose forceps shaft 120mm, straight, 3.0mm, Fig. 1	1x1
47242-00	nasal cutting fcps, TAKAHASHI shaft 120mm, 4x10mm tip, straight	1x1
09401-18	scissors nasal, HEYMANN 18cm	1x1
47159-20	LUBET-BARBON nasal dressing forceps, 20cm	1x1
41295-08	suction tube, FRAZIER/FERGUSSON 19cm, 30°, Charr. 8	1x1
49107-19	tongue depressor, BRUENINGS 19cm	1x1
47565-10	COTTLE columella forcep 10cm	1x1
11188-12	forceps tissue, ADSON-BROWN 7x7 teeth, 12cm	1x1
11190-10	forceps, GRAEFE 10,5cm	1x1
11102-14	forceps dressing, 14,5cm	1x1
11120-14	forceps tissue 1x2 t. 14,5 cm	1x1
45206-16	ear forceps bayonet, LUCAE without teeth, 16cm	1x1
21270-14	cotton applicators, FARREL threaded, 14cm	2x1
47380-15	nasal plastic knife, COTTLE 15cm	1x1
47554-01	retractor, COTTLE Fig. 1 14.5cm	1x1
47410-04	septum elevator, McKENTY 15cm, 4mm	1x1
33700-05	hammer, COTTLE flat/convex D. 30mm, 240gr., 18cm	1x1
47415-18	FREER septum elevator, 18cm double ended, sharp/blunt	1x1
47454-04	rhinoplastic osteotome, COTTLE 18cm, straight, 4mm	1x1
47454-07	rhinoplastic osteotome, COTTLE 18cm, straight, 7mm	1x1
47423-22	septum elevator, COTTLE 22cm	1x1
25214-18	needle holder, DE-BAKEY serrated, TC, 18cm	1x1
15111-09	towel forceps, BACKHAUS 9cm	6x1
47351-26	nasal snare angled, KRAUSE 26cm	1x1
47355-03	loops 0,3 mm bundle of 12 ea.	1x1
47385-15	nasal plastic knife, JOSEPH 15cm curved	1x1
89127-08	Bowl round, stainless steel 80 x 40mm, 0,14 l. (5,6 OZ)	1x1
33720-19	periosteal elevator, BOIES 19cm, 9mm	1x1
91122-16	bipolar forceps pointed straight, 16,5cm total long	1x1

SET/451:	Rhinoplastiksatz / Rhinoplasty Set / Juego para rinoplastia	
07109-15	scalpel handle MINI 15,5cm	1x1
07103-00	scalpel handle no. 3 12,5cm	1x1
47380-15	nasal plastic knife, COTTLE 15cm	1x1
21272-14	cotton applicators, FARREL triangular, 14cm	2x1
09341-11	operating sciss.fine, IRIS curved, 11cm	1x1
09305-14	operating sciss.fine, JOSEPH curved, 14,5cm	1x1
09617-13	Rhinoplastic scissors, FOMON curved, 13cm	1x1
09401-18	scissors nasal, HEYMANN 18cm	1x1
47454-04	rhinoplastic ostetome, COTTLE 18cm, straight, 4mm	1x1
47454-07	rhinoplastic osteotome, COTTLE 18cm, straight, 7mm	1x1
47473-01	rhinoplastic chisel, SILVER 18cm, straight	1x1
47473-02	rhinoplastic chisel, SILVER 18cm, curved right	1x1
47473-03	rhinoplastic chisel, SILVER 18cm, curved left	1x1
47554-01	retractor, COTTLE Fig. 1 14.5cm	1x1
47556-16	FOMON Alar Hooklet 16cm	1x1
47559-20	hooklet, COTTLE-NEIVERT double, 20cm	1x1
47551-16	nasal retracator, AUFRIEHT 16cm	1x1
47423-22	septum elevator, COTTLE 22cm	1x1
47426-22	septum elevator, KILLIAN 22cm	1x1
47410-04	septum elevator, McKENTY 15cm, 4mm	1x1
45206-14	ear forceps bayonet, LUCAE 14cm, without teeth	1x1
11188-12	forceps tissue, ADSON-BROWN 7x7 teeth, 12cm	1x1
47522-01	nasal rasp, FOMON 20cm, Fig. 1/2 TC	1x1
47522-04	nasal rasp, FOMON 20cm, Fig. 3/4 TC	1x1
47571-23	septum straight.fcps., ASCH 23cm	1x1
33700-05	hammer, COTTLE flat/convex D. 30mm, 240gr., 18cm	1x1
47532-19	nasal saw, JOSEPH 19cm, left	1x1
47534-19	nasal saw, JOSEPH 19cm, right	1x1
47120-75	nasal speculum, KILLIAN 75mm	1x1
47120-90	nasal speculum, KILLIAN 90mm	1x1
47223-01	WEIL-BLAKESLEY nose forceps shaft 120mm, straight, 3.0mm, Fig.1	1x1
47223-03	forceps, WEIL-BLAKESLEY shaft 120mm, straight, 4.2mm, Fig. 3	1x1
47461-00	COTTLE cartilage crusher	1x1
47255-01	nasal cut.fcps WATSON-WILLIAMS 7mm jaw straight, 120mm working lenth	1x1
25164-15	needle holder, CRILE-WOOD serrated, TC, 15cm	1x1
25164-18	needle holder, CRILE-WOOD serrated, TC, 18cm	1x1
41295-08	suction tube, FRAZIER/FERGUSSON 19cm, 30°, Charr. 8	1x1
41295-10	suction tube, FRAZIER/FERGUSSON 19cm, 30°, Charr. 10	1x1
47565-10	COTTLE columella forcep 10cm	1x1
47411-16	septum elevator, JOSEPH 16cm	1x1
47390-03	swivel knife, BALLENGER straight, 20cm, 3mm	1x1
47380-15	nasal plastic knife, COTTLE 15cm	1x1
33282-19	bone cut.fcps, COTTLE-KAZANJIAN 19cm	1x1
19216-02	hooklet sharp 2 prong, JOSEPH 2mm, 16cm	1x1
47323-19	septum fcps, MIDDLETON-JANSEN 19cm	1x1

SET/452:	Endonasaler Satz / Endonasal set / Juego endonasal	
41295-08	suction tube, FRAZIER/FERGUSSON 19cm, 30°, Charr. 8	1x1
41295-10	suction tube, FRAZIER/FERGUSSON 19cm, 30°, Charr. 10	1x1
45160-15	ear knife, POLITZER 15cm	1x1
47223-01	WEIL-BLAKESLEY nose forceps shaft 120mm, straight, 3.0mm, Fig. 1	1x1
47223-02	forceps, WEIL-BLAKESLEY shaft 120mm, straight, 3.6mm, Fig. 2	1x1
47223-03	forceps, WEIL-BLAKESLEY shaft 120mm, straight, 4.2mm, Fig. 3	1x1
47224-01	forceps, WEIL-BLAKESLEY shaft 120mm, 45° upcurved, size 1 3,0mm	
47224-02	forceps, WEIL-BLAKESLEY shaft 120mm, curved up, Fig. 2	1x1
47120-35	nasal speculum, KILLIAN 35mm	1x1
47120-50	Nasal speculum, KILLIAN 50mm	1x1
47120-75	nasal speculum, KILLIAN 75mm	1x1
47320-00	Biopsy fcps. with cup jaws	1x1
47195-01	nasal cutting forceps, LUC 19cm Fig. 1	1x1
47240-19	nasal cutting fcps., STRUYCKEN shaft 120mm, tip width 1,0mm	1x1
47315-00	OSTROEM Antrum punch up cutting, 2mm 100mm working length	1x1
09401-18	scissors nasal, HEYMANN 18cm	1x1
47305-01	nasal scissors, str. 11cm	1x1
47332-30	EICKEN (KILLIAN) antrum cannula 3.0mm long curved, 14cm long, stainless steel	1x1
47332-25	EICKEN (KILLIAN) antrum cannula 2.5mm long curved, 14cm long, stainless steel	1x1
47423-22	septum elevator, COTTLE 22cm	1x1
47158-20	WESTMACOTT nasal dressing forceps, 20cm	1x1

SET/453:	Satz für die endoskopische Nasennebenhöhlen-Chirurgie / Set for Endoscopic Paranasal Sinus / Juego para cirugía endoscópica del seno paranasal	
23181-40	Sinoscopy-trocar 5mm Ø, oblique beak 8,5cm long, f. endoscope 4mm Ø w. pyramidal trocar and obturator	1x1
47103-02	nasal specula HARTMANN Fig. 2	1x1
R500-040175-000	Sinuscope 4mm Ø, 0° angle of view autoclavable, intergrated fiber optic for illumination, 175mm work.length	1x1
R500-040175-030	Sinuscope 4mm Ø, 30° angle of view autoclavable, intergrated fiber optic f. illumination, 175mm work.length	1x1
91159-19	bipolar forceps angled 2mm, 19,5cm	1x1
51293-45	tonsil injection needle 45° angled	1x1
47580-19	Sickle knife 19cm long, pointed	1x1
47415-18	FREER septum elevator, 18cm double ended, sharp/blunt	1x1
47399-01	Antrum spoon 55° 19cm	1x1
47399-02	Antrum spoon, 90°, 19cm	1x1
47388-04	Antrum curette, curved, 20cm/2,5mm, 30° oval	1x1
47423-22	septum elevator, COTTLE 22cm	1x1
41295-08	suction tube, FRAZIER/FERGUSSON 19cm, 30°, Charr. 8	1x1
41295-10	suction tube, FRAZIER/FERGUSSON 19cm, 30°, Charr. 10	1x1
47332-25	EICKEN (KILLIAN) antrum cannula 2.5mm long curved, 14cm long, stainless steel	1x1
47332-30	EICKEN (KILLIAN) antrum cannula 3.0mm long curved, 14cm long, stainless steel	1x1
47324-01	Maxillary antrum grasping forceps, straight, 90° backward opening, rigid jaw, working length 100mm	1x1
47223-30	nose forceps BLAKESLEY, straight, 3,0mm, working length 130mm	1x1
47223-35	nose forceps BLAKESLEY, straight, 3,5mm, working length 130mm	1x1
47224-30	nose forceps BLAKESLEY, 45° curved up, 3mm, working length 130mm	1x1
47305-01	nasal scissors, str. 11cm	1x1
47317-70	Sinoscopy forceps, shaft length 12cm, horizontal cutting, oval, 70°	1x1
47318-70	Sinoscopy forceps, shaft length 12cm, vertical cutting, oval, 70°	1x1
47320-00	Biopsy fcps. with cup jaws	1x1
47315-00	OSTROEM Antrum punch up cutting, 2mm 100mm working length	1x1
47316-00	OSTROEM Antrum-punch right cutting, 2mm 100mm working length	1x1
47317-00	OSTROEM Antrum-punch left cutting, 2mm 100mm working length	1x1
47240-19	nasal cutting fcps.,STRUYCKEN shaft 120mm, tip width 1,0mm	1x1
47319-35	circular fcps. straight, dia. 3,5mm cutting 360°	1x1
47320-45	circular fcps. 4,5mm Ø, 65° upcurved	1x1

SET/460:	Tonsillektomie-Adenotomie Satz / Tonsillectomy and Adenoidectomy Set / Juego para amigdalactomia y adenotomia	
49342-01	tongue depress.,RUSSEL-DAVIS 29 x 67mm	1x1
49342-02	tongue depress.,RUSSEL-DAVIS 33 x 75mm	1x1
49342-03	tongue depress.,RUSSEL-DAVIS 38 x 85mm	1x1
49340-00	mouth gag only, DAVIS-MEYER	1x1
49111-15	tongue depressor, HARTMANN 15cm	1x1
47235-09	nasal cutting forceps,HARTMANN 9mm	1x1
49107-19	tongue depressor, BRUENINGS 19cm	1x1
53272-14	laryngeal mirror with handle Fig. 2, D. 14mm	1x1
53272-20	laryngeal mirror with handle Fig. 5, D. 20mm	1x1
51292-00	tonsil injection needle straight	1x1
51290-05	tonsil syringe 3 ring LL 5ml	1x1
15111-09	towel forceps, BACKHAUS 9cm	6x1
89127-08	Bowl round, stainless steel 80 x 40mm, 0,14 l. (5,6 OZ)	1x1
51256-28	tonsil snare, BRUENINGS 28cm	1x1
51259-04	tonsil loops 0,4mm Ø, pack of 12 pcs.	1x1
51209-20	tonsil seizing forceps,BLOHMKE 20cm	1x1
51205-18	tonsil seizing fcps, WHITE 18cm	1x1
09435-18	tonsil scissors, BOETTCHER curved, 18cm	1x1
05150-27	aspiration tube, YANKAUER complete, 27cm	1x1
51135-01	tonsil elevator, HENKE Fig. 1, 23cm	1x1
51183-19	tonsil forceps, SCHNIDT 19cm curved	1x1
13551-20	peritoneum forceps, MIKULICZ 20cm 1x2 teeth	1x1
11102-20	forceps dressing, 20cm	1x1
11120-20	forceps tissue 1x2 teeth, 20cm	1x1
47630-00	adenoid curette, BARNHILL 21cm, Fig. 0	1x1
47630-01	adenoid curette, BARNHILL 21cm, Fig. 1	1x1
47630-02	adenoid curette, BARNHILL 21cm, Fig. 2	1x1
47630-03	adenoid curette, BARNHILL 21cm, Fig. 3	1x1
47630-04	adenoid curette, BARNHILL 21cm, Fig. 4	1x1
51131-22	tonsil dissector, HURD 22cm	1x1
25214-18	needle holder, DE-BAKEY serrated, TC, 18cm	1x1
47245-01	naso-pharyngeal fcps. JURASZ 21cm, Fig.1	1x1
91154-19	bipolar forceps, 1mm tipstraight, 19,5cm long european flat connector	1x1

SET/470:	Laryngoskopiesatz für Erwachsene / Laryngoscopy Set for Adults / Juego de laringoscopia para adultos	
05301-04	operation laryng.,KLEINSASSER 170x28,5x18,5x15mm	1x1
05302-02	fiberglas-light-guide for 05301-03/04/ 05 and 06	1x1
05301-03	operation laryng.,KLEINSASSER 170x26x15,5x13,5mm	1x1
05302-02	fiberglas-light-guide for 05301-03/04/05 and 06	1x1
05301-02	operation laryng.,KLEINSASSER 150x20,5x13x10,5mm	1x1
05302-01	fiberglas-light-guide	1x1
05300-01	Chest support compl.KLEINSASSER for adults	1x1
53295-23	Needle holder with ratchet, straight jaw 1,8x3,5mm, serrated, WL 23cm	1x1
53280-01	micro laryngeal grasp.forceps straight serrated 1,5x10mm	1x1
53280-02	micro laryngeal grasp.forceps curved to left,serr.1,5x8,5mm	1x1
53280-03	micro laryngeal grasp.forceps curved to right,serr.1,5x8,5mm	1x1
53280-04	micro laryngeal cup forceps straight, 2,5mm Ø, 22cm long	1x1
53280-05	micro laryngeal cup forceps angled to left, 2,5mm	1x1
53280-06	micro laryngeal cup forceps angled to right, 2,5mm	1x1
53280-07	micro laryngeal cup forceps angled up 2,5mm	1x1
53280-08	micro laryngeal scissors straight vertical cutting 22cm long	1x1
53280-09	micro laryngeal scissors curved to left	1x1
53280-10	micro laryngeal scissors curved to right	1x1
41291-25	BYRD, suction tube, self cleaning, 2,5m	1x1
41292-01	injection cannula, straight, LUER-LOCK, working length 23cm	1x1
53290-08	handle for micro-laryngeal instruments	1x1
	53290-01 - 53290-07	
53290-01	micro-laryngeal sickle knife curved	1x1
53290-02	micro-laryngeal separador, oval, horizontal	1x1
53290-05	micro-laryngeal hook, 90° angled, blunt	1x1
41312-26	Coagulation suction tube monopolar 2,5mm button 3,5mm Ø, 260mm working length, angled, HF-connector male	1x1
R060-050040-003		1x1
	Monopolar HF-connecting cable, 3mtr. lg. 5mm PIN for ERBE / Storz HF-units 4mm socket instrument side	

SET/480:	Tracheotomie Satz / Tracheotomy Set / Juego para traqueotomía	
07103-00	scalpel handle no. 3 12,5cm	1x1
49107-19	tongue depressor, BRUENINGS 19cm	1x1
19220-01	retractor (trach.) pointed 1 prong, 16cm	1x1
19220-02	retractor (trach.) pointed 2 prongs, 16cm	1x1
19280-04	retractor, VOLKMANN pointed, 21,5cm, 4 teeth	2x1
55511-21	thyroid retractor, SCHOENBORN 21cm	1x1
19312-02	retractor, LANGENBECK 21cm, 30x14mm	2x1
19314-20	retractor, KOCHER-LANGENBECK 21cm, 60x20mm	2x1
21270-14	cotton applicators, FARREL threaded, 14cm	2x1
47415-18	FREER septum elevator, 18cm double ended, sharp/blunt	1x1
33718-16	periosteal elevator, JOSEPH 16cm, 4mm	1x1
09283-15	diss.scissors,METZENBAUM-FINO curved, 15cm	1x1
09110-14	operating scissors, STANDARD pointed/blunt, straight 14,5cm	1x1
47120-50	Nasal speculum, KILLIAN 50mm	1x1
47120-75	nasal speculum, KILLIAN 75mm	1x1
41295-08	suction tube, FRAZIER/FERGUSON 19cm, 30°, Charr. 8	1x1
41295-12	suction tube, FRAZIER/FERGUSON 19cm, 30°, Charr. 12	1x1
11102-14	forceps dressing, 14,5cm	1x1
11120-14	forceps tissue 1x2 t. 14,5 cm	2x1
11188-12	forceps tissue, ADSON-BROWN 7x7 teeth, 12cm	1x1
17110-20	dressing forceps, GROSS-MAIER straight, 20cm	1x1
51183-19	tonsil forceps, SCHNIDT 19cm curved	1x1
13310-16	hemost.fcps. ,ROCHESTER-PEAN straight,16cm	1x1
13310-14	hemost.fcps. ,ROCHESTER-PEAN straight, 14cm	1x1
13320-14	hemost.fcps.,ROCHESTER-OCHSNER 1x2 teeth, straight, 14cm	2x1
13221-12	hemost.fcps.,HALSTED-MOSQUITO curved, 12,0cm	4x1
15111-09	towel forceps, BACKHAUS 9cm	6x1
25164-15	needle holder, CRILE-WOOD serrated, TC, 15cm	1x1
19670-14	retractor, WEITLANER sharp, 14,0cm	1x1
47235-07	nasal cutting forceps,HARTMANN 7mm	1x1
55111-14	tracheal dilator, TROUSSEAU 14cm	1x1
55122-16	trachea hook, BOSE 16cm, left	1x1
55124-16	trachea hook, BOSE 16cm, right	1x1
55520-15	goitre seizing forceps, LAHEY 15cm	1x1
55501-15	goitre director, KOCHER 15cm, without hole	1x1
55240-08	trach.tube,CHEVALIER-JACKSON germ.silver,Fig.4, D. 8mm, 65m	1x1
55240-09	trach.tube,CHEVALIER-JACKSON germ.silver,Fig.5, D.9mm, 70mm	1x1
21110-14	grooved director, 14,5cm	1x1
55151-09	tube, WAGENER-MOSHER 9mm	1x1
91154-19	bipolar forceps, 1mm tip straight, 19,5cm long european flat connector	1x1

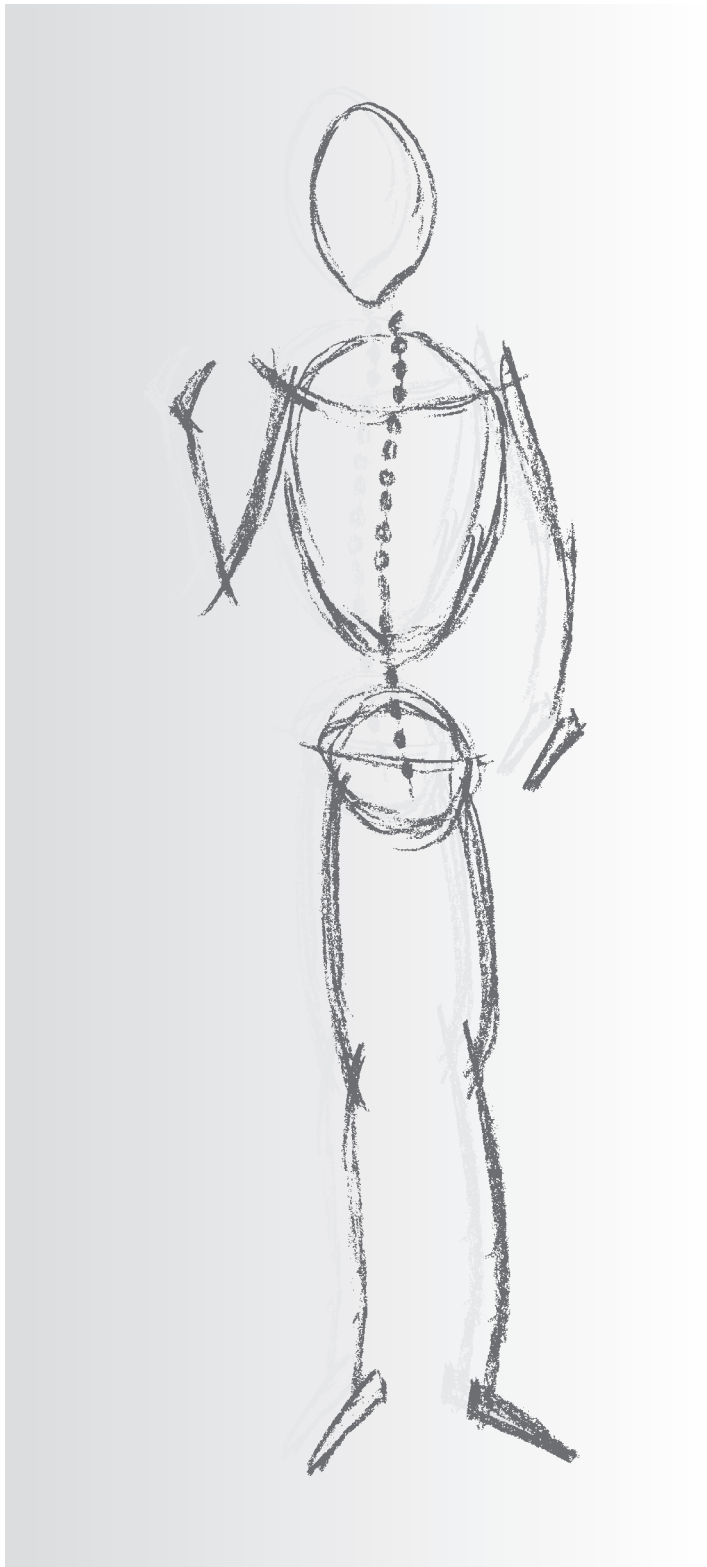

Reda Instrumente GmbH
Gänsäcker 34 - P.O. Box 131
D-78532 Tuttlingen

NUMMERNVERZEICHNIS

NUMERICAL INDEX

INDICE NUMÉRICO

03161-0048	05217-03324	05311-03.....339	09282-15 115, 189
03161-0149	05217-04324	05311-04.....339	09282-18189
03161-0250	05230-00330	05320-01340	09283-15 115, 189
03161-03C.....51	05230-00CL.....326	05320-02340	09283-18189
03161-03T51	05230-01330	05320-03340	09284-12188
03165-0722	05230-01CL.....326	05320-04340	09284-15 115, 188
03167-0322	05230-02330	05321-01340	09284-18188
03171-0052	05230-02CL.....326	05321-02340	09285-12 188, 297
03171-0152	05230-03330	05321-03340	09285-15 115, 188,
03171-0252	05230-03CL.....326	05321-04340 297
03180-9023	05230-04330	05322-01341	09285-18 188, 297
03180-9223	05230-04CL.....326	05322-02341	09285-20297
03180-9323	05233-18333	05322-03341	09285-23297
03192-0024	05234-28333	05322-04341	09285-25297
03192-0124	05238-02332	05322-05341	09285-28297
03193-0025	05238-03332	05322-06341	09285-30297
03193-0125	05238-12332	05322-07341	09286-15 115, 189
03193-2024, 25	05238-13332	07296-00221	09286-18189
03194-0027	05239-01333	07490-00220	09287-15 115, 189
03194-0127	05239-02333	07490-01220	09287-18189
03195-0026	05239-03332	07490-02220	09302-14190
03195-0126	05300-01335	07495-31221	09303-14190
03195-0626	05300-02335	07496-31221	09304-14 116, 190
03195-0726	05300-03335	07498-00221	09305-14 116, 190
03195-0826	05300-04335	07499-00221	09310-12191
03196-0027	05300-05335	07499-01221	09310-15191
05150-21284	05300-06335	09110-11117	09314-12191
05150-27284	05301-01334	09110-13117	09321-15191
05151-01284	05301-02334	09110-14117	09321-18191
05151-02284	05301-03334	09111-11117	09340-09192
05203-00327	05301-04334	09111-13117	09340-10192
05204-00327	05301-05334	09111-14117	09340-11 117, 192
05210-00328	05301-06334	09270-15189	09341-09192
05210-01328	05301-07334	09270-18189	09341-10192
05210-02328	05302-01334, 337,	09271-15189	09341-11 117, 192
05210-03328341	09271-18189	09342-08192
05210-04328	05302-02334, 337,	09274-15189	09343-08192
05211-00323341	09274-18189	09344-11 117, 192
05211-01323	05302-03334, 337,	09275-15189	09345-11 117, 192
05211-02323341	09275-18189	09346-11192
05211-03323	05303-01337	09280-12188	09348-01193
05211-04323	05303-10338, 341	09280-15 115, 188	09348-02193
05212-03322	05304-01338	09280-18188	09348-03193
05212-04322	05304-02338	09281-12 188, 297	09348-04193
05213-03329	05305-01336	09281-15 115, 188,	09348-05193
05213-03CL.....325	05305-02336297	09348-06193
05213-04329	05310-01339	09281-18 188, 297	09349-12194
05213-04CL.....325	05310-02339	09281-20297	09350-09195
05215-02331	05310-03339	09281-23297	09350-10194
05215-03331	05310-04339	09281-25297	09351-09195
05215-04331	05311-01339	09281-28297	09352-09195
05217-02324	05311-02339	09281-30297	09352-10194

09353-09 195	09981-11..... 192	10206-11..... 202	11260-15..... 95
09354-10 195	09982-12 197	10206-11SC..... 202	11270-12..... 95
09355-10 195	09983-12 197	10207-11..... 202	11270-15..... 95
09356-10 195	09984-11..... 196	10207-11SC..... 202	11272-15..... 151
09357-10 195	09985-11..... 196	10220-00 204	11273-15..... 151
09358-11..... 194	09993-15 191	10220-00T 204	11401-01..... 96
09360-11..... 196	09995-12 191	10220-25 204	11403-03..... 96
09361-11..... 196	10010-19 200	10220-25T 204	11403-04..... 96
09362-11..... 196	10011-19..... 200	10220-45 204	11404-04..... 96
09363-11..... 196	10012-19 200	10220-45T 204	11405-05..... 96
09364-10 298	10013-19 200	10220-60 204	11407-07..... 96
09370-11..... 116, 196	10014-19 200	10220-60T 204	13551-18 283
09371-11..... 116, 196	10015-19 200	10220-90 204	17131-21 295
09374-11..... 116, 196	10028-14 201	10220-90T 204	17133-17 295
09375-11..... 116, 196	10029-14 201	10226-11..... 205	17210-13 155
09401-18 198	10030-18 201	10226-14 205	17210-16 155
09403-15 198	10031-18 201	10226-18 205	17210-18 155
09405-16 198	10032-23 201	10226-18T 205	19122-13 263
09405-16TC..... 198	10033-23 201	10227-11..... 205	19210-12 246
09406-10 198	10034-14 201	10227-14 205	19211-12 246
09407-10 198	10035-14 201	10227-18 205	19212-01 246
09425-17 296	10036-18 201	10227-18T 205	19212-02 246
09427-17 296	10037-18 201	10228-11..... 205	19213-12 246
09435-18 296	10038-23 201	10228-14 205	19214-13 246
09437-19 296	10039-23 201	10228-18 205	19214-18 246
09439-17 296	10044-14 201	10228-18T 205	19215-01 246
09540-16 191	10045-14 201	10229-11..... 205	19215-02 246
09541-16 191	10048-14 201	10229-14 205	19215-03 246
09542-16 191	10049-14 201	10229-18 205	19215-13 246
09543-16 191	10050-12 116	10229-18T 205	19215-18 246
09544-16 191	10050-14 201	10230-11..... 205	19216-01 247
09545-16 191	10050-18 201	10230-14 205	19216-02 247
09617-13 198	10051-14 201	10230-18 205	19216-05 247
09802-09 199	10051-18 201	10230-18T 205	19216-07 247
09802-11..... 199	10061-19 200	11112-18 294	19216-10 247
09804-14 199	10061-19SC 200	11112-21 294	19217-03 247
09805-09 199	10061-19TC..... 200	11112-25 294	19217-05 247
09823-12 197	10061-23 200	11116-18 294	19217-07 247
09824-12 197	10061-23SC 200	11116-21 294	19218-01 248
09825-12 197	10061-23TC..... 200	11116-25 294	19218-02 248
09826-12 197	10201-11..... 202	11120-11 95	19218-11..... 248
09828-12 197	10201-11SC..... 202	11126-18..... 294	19220-01 249
09829-12 197	10202-11..... 203	11126-21 294	19220-02 249
09831-12 118, 299	10202-14 119, 203	11126-25 294	19220-03 249
09835-12 118, 299	10202-14T 203	11170-12 97	19220-04 249
09966-11..... 188	10202-18 203	11170-15 97	19221-01 249
09967-11..... 188	10202-18T 203	11180-12 97	19221-02 249
09970-14 188	10203-11..... 203	11180-15 97	19221-03 249
09970-18 188	10203-14 119, 203	11190-10 95, 151	19221-04 249
09971-14 188	10203-14T 203	11258-15 151	19226-02 249
09971-18 188	10203-18 203	11259-15 151	19226-03 249
09980-11..... 192	10203-18T 203	11260-12..... 95	19226-04 249

19227-02 249	21290-12 64	25673-18T 124	33470-06 104
19227-03 249	21290-14 64	25674-14 124	33474-96 103
19227-04 249	21290-16 64	25674-18 124	33474-97 103
19283-01 114	21292-12 64	25675-14 124	33474-98 103
19283-02 114	21292-14 64	25675-18 124	33475-00 103
19283-03 114	21292-16 64	25676-14 124	33475-01 103
19314-07 263	21310-15 64	25677-14 124	33475-02 103
19314-14 263	21320-12 64	25691-18 124	33475-03 103
19314-20 263	21320-18 64	25700-18 123	33475-04 103
19344-14 263	21350-25 347	25701-18 123	33475-05 103
19344-20 263	21360-26 347	25720-12 123	33475-06 103
19344-26 263	21370-25 347	25720-12D 123	33476-01 104, 258
19499-00 263	23128-19 215	25720-13 123	33476-02 104, 258
19610-07 110	23140-02 215	25720-13D 123	33476-03 104, 258
19611-07 110	23181-40 215	25720-14 123	33485-99 105
19620-07 110	25110-12 209	25720-14D 123	33486-00 105
19620-10 110	25114-12 209	25730-18 123	33486-01 105
19621-07 110	25128-13 209	25730-18D 123	33486-02 105
19621-10 110	25129-13 209	25731-12 123	33486-99 105
19630-10 110	25130-13 209	25731-13 123	33487-00 105
19631-10 110	25134-13 209	25731-14 123	33487-01 105
19634-10 110	25136-11 209	25731-18 123	33487-02 105
19635-10 110	25137-11 209	25731-18D 123	33487-99 258
19650-10 111	25140-13 209	33115-15 106	33488-00 258
19651-10 111	25144-13 209	33117-15 106	33488-01 258
19654-13 111	25160-15 209	33119-15 106	33488-02 258
19655-13 111	25164-15 209	33131-15 106	33490-10 103
19670-14 111	25660-12 123	33133-15 106	33490-20 103
19670-16 111	25660-13 123	33148-18 106	33490-30 103
19671-14 111	25660-14 123	33150-16 107	33490-40 103
19671-16 111	25661-12 123	33151-16 107	33490-50 103
19672-11 113, 264	25661-13 123	33156-18 107	33495-16 103
19673-11 113, 264	25661-14 123	33157-02 107	33496-00 105
19674-15 112	25668-18 124	33157-03 107	33496-01 105
19675-13 113	25670-14 124	33201-18 107	33496-12 105
19677-10 113, 264	25670-18 124	33205-18 107	33498-00 105
19677-13 113, 264	25671-12D 123	33211-15 107	33498-01 105
19683-17 112	25671-13D 123	33213-15 107	33498-12 105
19684-14 112	25671-14 124	33280-15 108	33600-02 98
19685-14 112	25671-14D 123	33281-15 108	33600-03 98
19690-17 265	25671-18 124	33282-19 108, 208	33600-04 98
19691-17 265	25672-14 124	33283-17 108, 208	33600-05 98
21115-10 63	25672-14D 124	33393-18 104	33602-04 98
21270-12 63	25672-14T 124	33469-96 104	33602-06 98
21270-14 63	25672-18 124	33469-97 104	33602-08 98
21270-16 63	25672-18D 124	33469-98 104	33602-10 98
21272-12 63	25672-18T 124	33470-00 104	33602-12 98
21272-14 63	25673-14 124	33470-01 104	33602-14 98
21272-16 63	25673-14D 124	33470-02 104	33602-16 98
21277-12 63	25673-14T 124	33470-03 104	33604-04 98
21277-14 63	25673-18 124	33470-04 104	33604-06 98
21277-16 63	25673-18D 124	33470-05 104	33604-08 98

33604-10 98	33665-12 100	41295-15 125, 213	41511-01 181
33604-12 98	33686-25 259	41297-06 213	41511-02 181
33604-14 98	33693-32 102, 259	41297-07 213	41511-03 181
33604-16 98	33694-01 102, 259	41297-08 213	41511-04 181
33605-04 98	33694-02 259	41297-09 213	41511-05 181
33605-06 98	33694-03 102, 259	41297-10 213	41512-01 181
33605-08 98	33695-40 260	41297-11 213	41512-02 181
33605-10 98	33696-75 260	41297-12 213	41512-03 181
33605-12 98	33698-98 102, 260	41299-03 128	41512-04 181
33605-14 98	33700-05 102, 260	41299-05 128	41512-05 181
33605-16 98	33700-08 102	41299-07 128	41803-01 57
33620-02 99	33701-16 91	41300-00 129	41807-00 57
33620-03 99	33702-15 90	41300-02 126	41810-10 57
33620-04 99	33703-15 90	41300-03 126	41821-21 57, 148
33620-05 99	33707-17 86	41300-04 126	41842-44 148
33620-06 99	33708-19 86	41300-05 126	41843-50 148
33623-02 99	33710-19 86	41302-02 125	41850-41 148
33623-03 99	33711-16 87	41303-09 126, 214	43376-13 250
33623-04 99	33712-16 87	41303-12 126, 214	43377-13 250
33623-05 99	33713-16 87	41303-15 126, 214	43602-01 261
33623-06 99	33713-17 87	41303-18 126, 214	43602-02 261
33626-25 98, 235	33714-15 86	41303-25 126, 214	43602-03 261
33626-35 98, 235	33716-18 92	41303-30 126, 214	43613-00 262, 293
33628-03 98	33718-16 88	41303-45 126, 214	43614-00 262, 293
33628-05 98	33720-19 226	41304-06 126	43614-01 262, 293
33652-02 99, 229	33720-20 226	41304-08 126	43614-12 262, 293
33652-03 99, 229	33722-06 90, 227	41304-10 126	43614-23 262, 293
33652-04 99, 229	33722-08 90, 227	41305-05 129	43614-34 262, 293
33652-06 99, 229	33724-02 92	41305-06 129	43614-45 262, 293
33652-08 99, 229	33724-03 92	41305-07 129	43614-56 262, 293
33652-10 99, 229	33724-04 92	41305-08 129	43614-67 262, 293
33652-12 99, 229	33740-19 89	41305-09 129	43614-78 262, 293
33652-15 99, 229	33741-18 89	41305-10 129	44650-01 131
33654-02 99, 229	33742-18 89	41305-12 129	44650-02 131
33654-03 99, 229	33743-18 89	41305-15 129	44651-01 131
33654-04 99, 229	33761-21 290	41305-18 129	44651-02 131
33654-06 99, 229	34520-02 302	41305-20 129	44652-01 131
33654-08 99, 229	34520-03 302	41305-25 129	44652-02 131
33654-10 99, 229	34520-04 302	41305-30 129	45009-02 53
33654-12 99, 229	41291-20 348	41306-00 127	45009-03 53
33654-15 99, 229	41291-25 348	41306-05 125, 127	45009-04 53
33660-15 228	41291-30 348	41306-07 125, 127	45010-00 53
33660-20 228	41292-01 349	41306-09 125, 127	45010-20 53
33664-04 100	41292-02 349	41307-00 129	45010-30 53
33664-06 100	41294-40 213	41308-00 127	45010-45 53
33664-08 100	41295-06 125, 213	41312-10 211, 348	45010-55 53
33664-10 100	41295-07 125, 213	41312-26 211, 348	45010-65 53
33664-12 100	41295-08 125, 213	41510-01 181	45010-75 53
33665-04 100	41295-09 125, 213	41510-02 181	45011-00 53
33665-06 100	41295-10 125, 213	41510-03 181	45011-03 53
33665-08 100	41295-11 125, 213	41510-04 181	45011-04 53
33665-10 100	41295-12 125, 213	41510-05 181	45011-05 53

45011-07..... 53	45060-03 58	45111-00..... 68	45193-03 66, 250
45011-08..... 53	45060-04 58	45112-00..... 68	45194-01 67
45012-00 53	45060-05 58	45112-01..... 68	45194-02 67
45012-40 53	45061-00 58	45112-02..... 68	45194-03 67
45012-55 53	45070-01 58	45112-03..... 69	45194-04 67
45012-65 53	45070-02 58	45112-04..... 69	45195-00 67
45012-75 53	45070-03 58	45112-05..... 69	45195-01 67
45014-00 53	45070-04 58	45114-00..... 68	45195-02 67
45014-45 53	45070-05 58	45115-00..... 68	45195-15 66
45014-55 53	45070-06 58	45115-01..... 68	45201-11 94, 152
45014-65 53	45071-00 58	45115-02..... 68	45201-13 94, 152
45014-75 53	45072-01 59	45115-03..... 69	45203-11 94, 152
45015-00 53	45073-01 59	45115-04..... 69	45206-14 94, 152
45015-45 53	45073-02 59	45115-05..... 69	45206-16 94, 152
45015-55 53	45073-03 59	45116-00..... 68	45207-16 94, 152
45015-65 53	45073-04 59	45117-00..... 68	45208-14 94, 152
45018-00 53	45073-05 59	45117-01..... 68	45209-12 97
45018-50 53	45073-06 59	45117-02..... 68	45220-16 72
45018-60 53	45074-01 59	45117-03..... 69	45222-17 72
45018-70 53	45075-00 59	45117-04..... 69	45225-02 72
45018-80 53	45076-01 59	45117-05..... 69	45243-14 74, 155
45019-30 54	45080-00 60	45133-01 70	45245-12 74
45019-40 54	45090-00 60	45133-02 70	45246-12 74
45019-45 54	45090-02 60	45133-03 70	45246-14 74
45019-50 54	45090-03 60	45133-04 70	45251-10 73
45019-55 54	45090-04 60	45133-05 70	45253-11 73
45019-60 54	45090-05 60	45150-18 70	45255-08 75
45019-65 54	45090-06 60	45151-16 70	45257-08 75, 175
45019-70 54	45090-08 60	45152-01 70	45261-08 75
45019-75 54	45091-00 61	45152-02 70	45261-14 75
45020-30 54	45091-01 61	45153-16 71	45261-16 75
45020-40 54	45091-02 61	45160-15 71	45263-08 75
45020-45 54	45091-03 61	45162-18 71	45263-14 75
45020-50 54	45091-04 61	45164-17 71	45265-08 75
45020-55 54	45091-15 61	45165-17 71	45267-20 75, 175
45020-60 54	45091-17 61	45171-12 65	45267-25 75, 175
45020-65 54	45091-22 61	45173-12 65	45267-30 75
45020-70 54	45096-00 62	45180-01 65	45269-30 75
45020-75 54	45096-50 61	45180-02 65	45271-08 75
45030-04 55	45096-75 61	45180-03 65	45273-08 75
45030-06 55	45097-01 61	45181-13 65	45274-08 75
45030-07 55	45097-02 61	45184-16 65	45275-08 75, 175
45030-08 55	45097-03 61	45185-15 65	45276-08 75
45030-10 55	45097-10 61	45190-01 66	45300-30 80
45036-03 56	45097-15 61	45190-02 66	45310-40 80
45036-06 56	45109-00 68	45192-01 66	45312-55 80
45036-07 56	45110-00 68	45192-02 66	45313-55 80
45036-08 56	45110-01 68	45192-03 66	45315-55 80
45036-09 55	45110-02 68	45192-04 66	45317-55 80
45036-10 55	45110-03 69	45192-05 66	45320-70 80
45060-01 58	45110-04 69	45193-01 66, 250	45321-70 80
45060-02 58	45110-05 69	45193-02 66, 250	45322-70 80

45324-03 82	45704-15 122	45737-15 136	47050-07 140
45325-03 82	45705-15 122	45741-03 136	47060-01 140
45350-40 76	45706-35 122	45741-06 136	47060-02 140
45350-70 76	45708-16 121	45741-10 136	47060-03 140
45352-40 76	45709-10 120	45743-03 136	47102-01 141
45353-60 76	45709-14 120	45743-06 136	47102-02 141
45355-60 76	45709-16 120	45743-10 136	47102-03 141
45357-40 76	45709-20 120	45745-03 136	47103-01 142
45359-40 76	45709-26 120	45745-06 136	47103-02 142
45360-35 76	45709-28 120	45745-10 136	47103-03 142
45361-01 77	45709-30 120	45746-20 137	47112-01 143
45361-02 77	45710-14 120	45747-03 136	47112-02 143
45361-03 77	45710-15 135	45747-06 136	47112-03 143
45361-04 77	45710-20 120	45747-10 136	47113-03 143
45361-05 77	45710-25 120	45748-16 137	47116-13 144
45362-45 77	45711-15 135	45749-16 137	47116-14 144
45363-45 77	45713-15 135	45750-16 137	47118-13 144
45365-45 77	45715-17 135	45751-16 93	47120-35 144
45367-50 77	45720-03 135	45753-16 93	47120-35S 145
45369-50 77	45720-06 135	45755-16 93	47120-50 144
45370-50 81	45720-10 135	45756-10 138	47120-50S 145
45371-40 81	45722-03 135	45756-20 138	47120-75 144
45372-60 81	45722-04 135	45756-30 138	47120-75S 145
45385-01 84	45722-06 135	45756-40 138	47120-90 144
45385-02 84	45722-08 135	45756-50 138	47120-90S 145
45387-01 84	45722-10 135	45757-16 93	47124-35 146
45387-02 84	45722-12 135	45758-01 93	47124-35S 147
45390-35 78	45722-15 135	45758-02 93	47124-50 146
45390-50 78	45722-20 135	45758-03 93	47124-50S 147
45391-35 78	45722-25 135	45760-01 133	47124-75 146
45392-35 78	45724-03 135	45760-02 133	47124-75S 147
45393-50 78	45724-04 135	45762-01 133	47124-90 146
45394-50 78	45724-06 135	45762-02 133	47124-90S 147
45400-01 79	45724-08 135	45766-35 132	47139-12 345
45400-02 79	45724-10 135	45766-40 132	47139-14 345
45400-03 79	45724-12 135	45766-45 132	47139-16 345
45401-25 79	45724-15 135	45766-50 132	47139-18 345
45402-10 79	45724-20 135	45770-01 134	47151-15 149
45403-13 79	45724-25 135	45770-16 137	47151-18 149
45404-13 79	45725-05 135	45771-16 137	47154-20 150
45410-01 83	45725-10 135	45802-16 88	47155-20 150
45411-01 83	45730-03 136	45803-16 88	47158-20 154
45412-01 83	45730-06 136	45805-16 88	47159-20 154
45413-01 83	45730-10 136	45806-16 88	47161-16 154
45414-01 83	45732-03 136	45806-17 92	47161-20 154
45430-00 85	45732-06 136	45807-20 91	47167-18 156
45440-19 85	45732-10 136	47050-01 140	47169-18 156
45701-01 122	45733-05 136	47050-02 140	47171-14 155
45701-02 122	45733-10 136	47050-03 140	47173-14 155
45702-01 121	45735-05 136	47050-04 140	47181-18 157
45702-02 121	45735-10 136	47050-05 140	47185-18 157
45703-15 122	45736-15 136	47050-06 140	47191-01 158

47191-02 158	47231-01 171	47317-00 184	47332-30 212
47191-03 158	47231-02 171	47317-11 178	47332-40 212
47191-04 158	47232-00 172	47317-70 178	47342-25 261
47192-18 158	47233-00 173	47317-90 178	47342-30 261
47193-01 158	47233-01 173	47318-00 184	47342-40 261
47193-02 158	47233-02 174	47318-11 178	47345-15 212
47195-01 157	47233-03 174	47318-70 178	47347-20 227
47195-02 157	47235-05 169	47318-90 178	47350-26 162
47197-01 157	47235-07 169	47319-00 15	47351-26 162
47197-02 157	47235-09 169	47319-35 186	47352-24 163
47223-00 164	47235-11 169	47319-45 186	47355-03 163
47223-01 164	47235-13 307	47320-00 167	47370-16 216
47223-02 164	47235-15 307	47320-11 178	47371-16 216
47223-03 164	47239-01 169	47320-35 186	47372-16 216
47223-04 164	47239-02 169	47320-45 186	47372-17 219
47223-05 164	47241-00 165	47320-70 178	47373-16 216
47223-30 180	47242-00 165	47320-90 178	47374-16 216
47223-35 180	47242-01 165	47321-00 185	47375-16 216
47223-40 180	47243-00 310	47321-11 176	47375-19 216
47224-00 164	47244-00 311	47321-70 178	47376-16 217
47224-01 164	47245-01 311	47321-90 178	47377-13 219
47224-02 164	47245-02 311	47322-00 185	47379-16 217
47224-03 164	47246-18 310	47322-11 178	47380-15 217
47224-04 164	47251-21 161	47322-70 178	47382-15 217
47224-05 164	47255-01 166	47322-90 178	47384-15 217
47224-30 180	47255-02 166	47323-00 185	47385-15 217
47224-35 180	47256-20 206	47323-10 178	47386-01 217
47224-40 180	47303-03 109, 182	47323-19 159	47386-02 217
47225-01 164	47303-04 109, 182	47323-80 178	47387-01 256
47225-02 164	47303-05 109, 182	47324-00 185	47387-02 256
47225-03 164	47303-06 109, 182	47324-01 176	47388-01 257
47225-04 164	47304-01 182	47324-02 176	47388-02 257
47226-01 168	47304-02 182	47324-03 177	47388-03 257
47226-02 168	47304-03 182	47324-04 177	47388-04 257
47226-03 168	47304-04 182	47324-05 177	47388-05 257
47226-30 180	47305-01 187	47325-00 185	47390-03 218
47226-35 180	47305-02 187	47325-01 179	47390-04 218
47226-40 180	47305-03 187	47325-02 179	47390-05 218
47227-01 168	47310-00 184	47325-03 179	47392-03 218
47227-02 168	47311-00 184	47325-19 159	47392-04 218
47227-03 168	47311-10 109	47326-01 179	47392-05 218
47227-30 180	47311-25 109	47326-02 179	47399-01 257
47227-35 180	47311-30 109	47326-03 179	47399-02 257
47227-40 180	47312-00 184	47327-01 179	47410-04 92, 222
47230-00 170	47313-00 184	47327-02 179	47410-05 92, 222
47230-01 170	47314-00 184	47327-03 179	47410-16 222
47230-02 170	47315-00 184	47331-20 212	47411-16 222
47230-03 170	47316-00 184	47331-25 212	47412-20 226
47230-04 170	47316-11 178	47331-30 212	47413-19 222
47230-05 170	47316-16 183	47331-40 212	47414-21 222
47230-06 170	47316-70 178	47332-20 212	47415-18 91, 223
47231-00 171	47316-90 178	47332-25 212	47417-19 223

47419-19 223	47472-16 232	47541-14 251	47642-01 309
47420-01 223	47473-01 233	47542-12 251	47642-02 309
47420-02 223	47473-02 233	47551-16 251	47642-03 309
47420-03 223, 261	47473-03 233	47551-16CL 251	49102-16 268
47420-04 224	47474-01 233	47552-16 251	49104-15 268
47420-20 224	47474-02 233	47553-15 252	49105-16 268
47421-21 224	47474-03 233	47554-01 253	49106-01 268
47421-23 224	47475-04 234	47554-02 253	49107-19 268
47422-22 224	47475-06 234	47554-03 253	49108-15 268
47423-22 224	47475-08 234	47555-08 253	49109-19 268
47424-16 225	47482-05 236	47556-16 253	49110-19 269
47425-19 225	47484-04 236	47557-17 253	49111-15 269
47426-22 225	47484-06 236	47558-15 254	49115-01 269
47427-21 261	47484-08 236	47559-20 252	49115-02 269
47428-21 225	47486-16 236	47560-18 254	49117-11 269
47430-22 225	47487-16 236	47562-18 254	49119-14 270
47450-04 100, 230	47489-16 236	47563-22 255	49230-11 270
47451-04 100, 230	47502-16 238	47564-16 254	49231-12 270
47454-04 100, 231	47504-18 238	47565-10 153	49231-14 270
47454-07 100, 231	47507-17 238	47566-12 252	49231-16 270
47454-09 100, 231	47507-18 238	47568-08 255	49235-19 270
47454-12 100, 231	47511-21 239	47569-14 250	49250-16 270
47455-06 231	47513-21 239	47571-23 160	49250-18 270
47457-03 235	47514-16 239	47572-23 160	49255-16 270
47457-05 235	47516-16 239	47573-23 160	49265-12 271
47458-04 231	47518-21 239	47575-23 160	49265-14 271
47458-07 231	47520-21 240	47601-21 256	49267-12 271
47458-09 231	47522-01 241	47607-01 256	49270-16 271
47458-12 231	47522-04 241	47607-02 256	49270-19 271
47460-04 231	47522-05 241	47607-03 256	49272-13 271
47460-07 231	47522-07 241	47607-04 256	49274-09 271
47460-12 231	47522-09 241	47607-05 256	49274-11 271
47461-00 237	47523-01 238	47607-06 256	49274-13 271
47463-10 234	47523-02 238	47620-00 308	49274-15 271
47463-12 234	47524-01 238	47620-01 308	49287-02 272
47463-14 234	47525-20 238	47620-02 308	49287-03 272
47470-04 232	47526-16 243	47620-03 308	49287-04 272
47470-05 232	47526-20 238	47620-04 308	49287-05 272
47470-06 232	47527-16 243	47620-05 308	49288-02 272
47470-07 232	47528-01 242	47620-06 308	49288-03 272
47471-02 101, 232	47528-02 242	47630-00 308	49288-04 272
47471-03 101, 232	47529-16 243	47630-01 308	49288-05 272
47471-04 101, 232	47530-00 130, 244	47630-02 308	49310-00 273
47471-05 101, 232	47530-01 130, 244	47630-03 308	49310-01 273
47471-06 101, 232	47530-02 130, 244	47630-04 308	49310-02 273
47471-07 101, 232	47532-19 244	47636-01 309	49310-03 273
47471-08 101, 232	47533-19 244	47636-02 309	49310-04 273
47471-10 101, 232	47534-19 244	47636-03 309	49310-05 273
47471-12 101, 232	47535-01 245	47636-04 309	49310-09 274
47472-10 232	47535-02 245	47641-01 309	49310-10 274
47472-12 232	47535-20 245	47641-02 309	49310-11 274
47472-14 232	47540-16 251	47641-03 309	49310-12 274

49315-00 275	50237-35 31	51185-19 281	53131-20 354
49315-01 275	50237-40 31	51187-19 281	53132-20 354
49315-02 275	50237-45 31	51191-19 281	53132-30 354
49315-03 275	50237-50 31	51193-19 281	53132-40 354
49315-10 275	50237-60 31	51202-19 281	53132-50 354
49317-00 276	50237-70 31	51203-19 281	53132-60 354
49317-01 276	50238-35 31	51205-18 281	53150-00 354
49317-02 276	50238-40 31	51205-23 281	53152-00 354
49317-03 276	50238-45 31	51207-21 281	53154-00 354
49317-10 276	50238-50 31	51209-20 281	53155-00 354
49320-00 277	50242-07 30	51210-20 282	53157-00 354
49320-01 277	50242-08 30	51211-21 282	53158-02 354
49320-02 277	50242-10 30	51213-21 282	53158-03 354
49320-03 277	50242-15 30	51214-20 283	53160-02 354
49320-10 277	50242-18 30	51215-20 283	53160-03 354
49320-20 277	50242-20 30	51219-22 282	53162-00 354
49340-00 277	50242-23 30	51250-28 301	53164-01 354
49341-00 277	50242-25 30	51252-28 301	53164-02 354
49342-01 278	50242-27 30	51256-28 301	53166-00 354
49342-02 278	50242-30 30	51257-40 302	53170-00 354
49342-03 278	50242-35 30	51257-50 302	53175-00 354
49342-04 278	50242-40 30	51259-03 302	53177-01 354
49342-05 278	50242-45 30	51259-04 302, 319	53177-02 354
49345-01 279	50242-50 30	51259-05 302	53230-01 356
49345-02 279	50242-60 30	51260-00 300	53230-02 356
49345-03 279	50242-70 30	51265-00 303	53230-03 356
49345-04 279	51103-18 288	51270-00 305	53230-04 356
49345-05 279	51103-20 288	51290-02 210, 306	53230-05 356
49360-10 280	51103-22 288	51290-05 210, 306	53230-06 356
49400-01 280	51104-18 288	51290-10 210, 306	53230-07 356
50236-06 30	51109-24 289	51290-20 210, 306	53230-08 356
50236-08 30	51111-23 289	51291-00 210, 306,	53240-01 356
50236-10 30	51131-22 290 344	53240-02 356
50236-14 30	51133-23 290	51292-00 210, 306,	53240-03 356
50236-18 30	51134-21 290 344	53240-04 356
50236-23 30	51135-01 290	51293-00 210, 306,	53240-05 356
50236-31 30	51135-02 290 344	53240-06 356
50236-35 30	51139-25 291	51293-45 210, 306,	53240-07 356
50236-40 30	51143-24 291 344	53240-08 356
50236-45 30	51151-19 292	51293-90 210, 306,	53250-01 356
50236-50 30	51165-22 285 344	53250-02 356
50236-60 30	51167-22 285	53101-22 343	53250-03 356
50236-70 30	51168-23 285	53102-20 343	53250-04 356
50237-06 31	51170-24 286	53103-22 343	53250-05 356
50237-08 31	51171-22 286	53111-18 342	53250-06 356
50237-10 31	51172-19 287	53115-01 342	53250-07 356
50237-14 31	51173-21 287	53115-02 342	53250-08 356
50237-18 31	51174-21 287	53115-03 342	53260-01 356
50237-23 31	51176-20 304	53115-04 342	53260-02 356
50237-25 31	51177-23 287	53121-24 343	53260-03 356
50237-27 31	51181-19 281	53122-00 319	53260-04 356
50237-30 31	51183-19 281	53130-00 354	53260-05 356

53260-06 356	53290-05 352	91010-02 34	91127-16..... 36
53260-07 356	53290-06 352	91010-03 34	91142-16..... 37
53260-08 356	53290-07 352	91010-11..... 34	91144-16..... 37
53270-08 346	53290-08 353	91010-12 34	91146-16..... 37
53270-10 346	53290-11..... 353	91010-13 34	91152-19..... 37
53270-12 346	53290-12 353	91010-14 34	91154-19..... 37
53270-14 346	53290-13 353	91010-15 34	91157-19..... 37
53270-16 346	53290-14 353	91010-16 34	91159-19..... 37
53270-18 346	53290-15 353	91010-17 34	91160-03N 40
53270-20 346	53290-16 353	91010-18 34	91160-05N 40
53270-22 346	53295-23 349	91010-21 34	91160-10N 40
53270-24 346	55111-13..... 314	91010-31 34	91160-20N 40
53270-26 346	55111-14..... 314	91010-33 34	91162-05N 40
53270-28 346	55113-14..... 314	91010-34 34	91162-10N 40
53270-30 346	55115-07..... 314	91010-35 34	91162-19..... 38
53272-08 346	55116-15..... 314	91010-36 34	91164-19..... 38
53272-10 346	55117-17..... 314	91011-51..... 35	91166-03N 41
53272-12 346	55118-16..... 315	91011-52..... 35	91166-05N 41
53272-14 346	55119-16..... 315	91011-53..... 35	91166-10N 41
53272-16 346	55120-15 315	91011-54..... 35	91166-19..... 38
53272-18 346	55122-16 315	91011-55..... 35	91166-20N 41
53272-20 346	55124-16 315	91011-56..... 35	91167-19..... 38
53272-22 346	55151-05 315	91011-61..... 35	91168-05N 41
53272-24 346	55151-07 315	91011-62..... 35	91168-10N 41
53272-26 346	55151-09 315	91020-01 35	91169-19..... 38
53272-28 346	55220-04 316	91020-02 35	91172-03..... 38
53272-30 346	55220-05 316	91020-03 35	91172-07..... 38
53274-12 346	55220-06 316	91020-04 35	91172-12..... 38
53276-10 346	55220-07 316	91022-05 35	91176-19..... 44
53280-01 350	55220-08 316	91022-10 35	91177-20 44
53280-02 350	55220-09 316	91022-20 35	91178-14..... 45
53280-03 350	55220-10 316	91024-10 35	91179-18N 43
53280-04 351	55220-11..... 316	91024-15 35	91180-05N 40
53280-05 351	55220-12 316	91024-20 35	91180-10N 40
53280-06 351	55220-13 316	91030-02 35	91180-20N 40
53280-07 351	55240-04 316	91030-04 35	91182-10N 40
53280-08 351	55240-05 316	91030-06 35	91182-20N 40
53280-09 351	55240-06 316	91102-11..... 36	91200-05N 40
53280-10 351	55240-07 316	91104-11..... 36	91200-10N 40
53280-11 351	55240-08 316	91109-11..... 36	91200-20N 40
53280-12 351	55240-09 316	91110-03N 40	91201-20S 42
53280-16 350	55240-10 316	91110-05N 40	91202-05N 40
53280-17 350	55240-11..... 316	91110-10N 40	91202-10N 40
53280-18 350	55240-12 316	91112-03N 40	91202-20N 40
53280-19 351	55240-13 316	91112-05N 40	91206-05N 41
53280-20 351	55501-15 317	91112-10N 40	91206-10N 41
53280-21 351	55503-15 317	91113-11 36	91206-20N 41
53280-22 351	55511-21..... 317	91115-11 36	91207-10N 41
53290-01 352	55520-15 318	91122-16..... 36	91208-10N 41
53290-02 352	55520-20 318	91123-16..... 36	91220-10N 40
53290-03 352	55523-17 318	91124-16..... 36	91220-20N 40
53290-04 352	91010-01 34	91125-16..... 36	91222-10N 40

91222-20N.....	40	R400-027175-070...15
91226-05N.....	41	R400-040175-000...15
91226-10N.....	41	R400-040175-030...15
91226-20N.....	41	R400-040175-045...15
91227-10N.....	41	R400-040175-070...15
91228-10N.....	41	R501-027041-000...17
91240-10N.....	40	R501-027041-030...17
91242-10N.....	40	R501-040050-000...17
91246-05N.....	41	R501-040050-030...17
91246-10N.....	41	R503-100148-070...17
91246-20N.....	41	R503-100173-070...17
91300-10N.....	40	R503-110145-090...17
91300-20N.....	40	R503-110173-090...17
93250-15T.....	123	R805-130402-034...14
93250-18T.....	123	R900-000000-01.....20
93251-15T.....	123	R900-000000-02.....20
93251-18T.....	123	R900-000000-03.....20
93260-15T.....	123	R900-000000-04.....20
93260-18T.....	123	R900-000000-05.....20
93261-15T.....	123	R900-000000-06.....20
93261-18T.....	123	R900-000000-07.....20
93755-14.....	207	R900-000000-09.....20
93756-14.....	207	R900-000000-11.....20
93757-14.....	207	R900-000000-13.....20
R010-030302-000...18		R900-000000-15.....20
R010-030302-030...18		R900-000000-21.....20
R010-050240-000...18		R900-000000-31.....20
R010-050240-030...18		R900-035180-00.....19
R010-050240-070...18		R900-035230-00.....19
R010-055490-000...18		R900-035300-00.....19
R010-055490-030...18		R900-035350-00.....19
R065-020080-003...39		R900-048180-00.....19
R065-020080-005...39		R900-048230-00.....19
R065-020080-103...39		R900-048250-00.....19
R065-020080-105...39		R900-048300-00.....19
R065-040000-003...39		R900-048350-00.....19
R065-040000-005...39		R901-035180-00.....19
R065-040000-103...39		R901-035230-00.....19
R065-040000-105...39		R901-035300-00.....19
R065-040125-003...39		R901-035350-00.....19
R065-040125-005...39		R901-048180-00.....19
R065-040125-103...39		R901-048230-00.....19
R065-040125-105...39		R901-048250-00.....19
R065-040285-003...39		R901-048300-00.....19
R065-040285-005...39		R901-048350-00.....19
R065-040285-103...39		
R065-040285-105...39		
R300-040302-000...16		
R300-040302-030...16		
R300-040302-070...16		
R400-027175-000...15		
R400-027175-030...15		

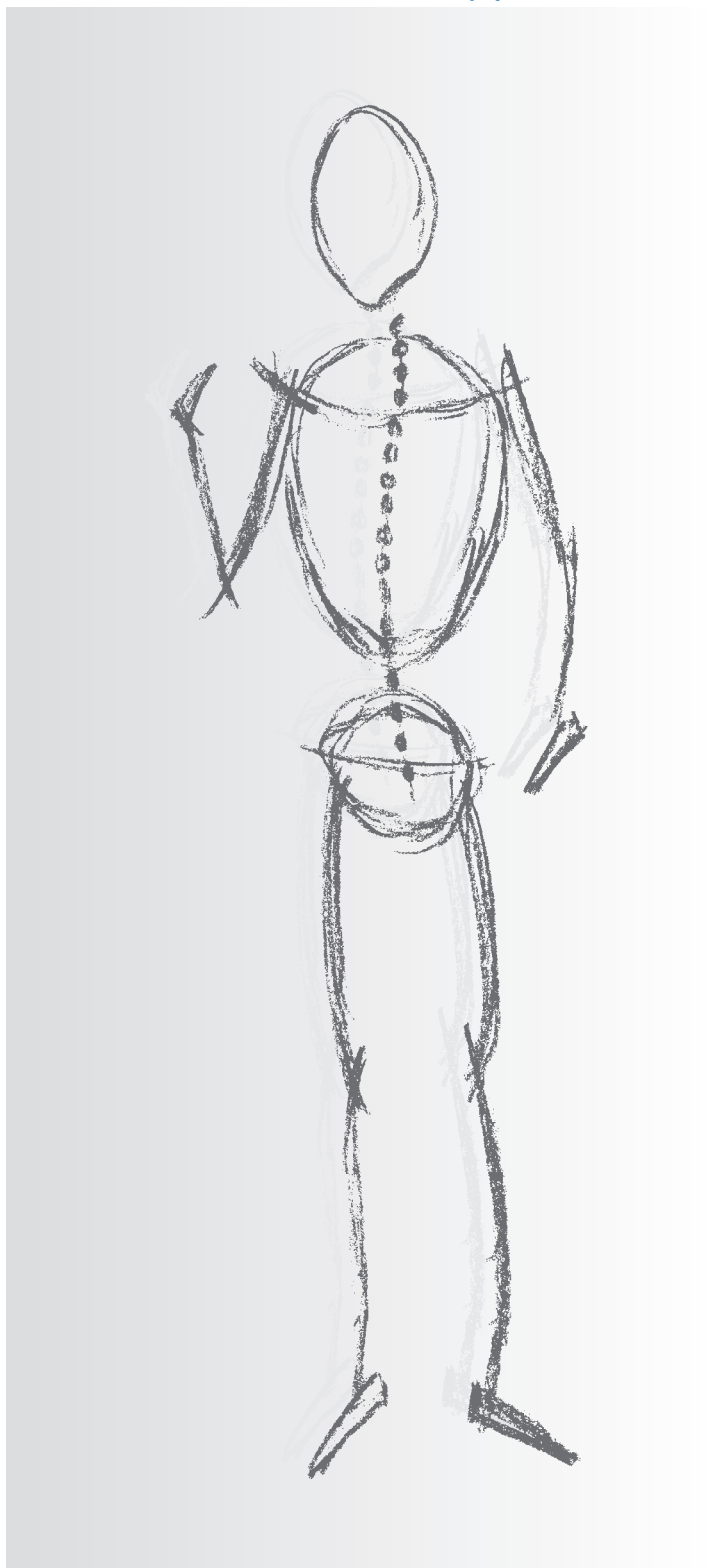

Reda Instrumente GmbH
Gänsäcker 34 - P.O. Box 131
D-78532 Tuttlingen

ALPHABETISCHER INDEX

ALPHABETICAL INDEX

INDEX ALPHABÉTICO

A		
ABRAHAM, Tonsillennmesser	287	
ABRAHAM, Tonsillenzange	282	
Absaugrohr f. Laryngoskope	338	
ACM-Kaltlichtkabeladapter	20	
Adapter	20	
Adapter Winter+IBE	20	
Adapter, ACM	20	
Adapter, Aesculap	20	
Adapter, British	20	
Adapter, Codman	20	
Adapter, Comeg	20	
Adapter, Dyonics	20	
Adapter, Endoskope	20	
Adapter, Fuji	20	
Adapter, Heine	20	
Adapter, Henke-Sass-Wolf	20	
Adapter, HOUSE	129	
Adapter, Kaltlichtkabel	20	
Adapter, Lichtquellen	20	
Adapter, Medicon	20	
Adapter, MLW	20	
Adapter, Olympus	20	
Adapter, Pentax	20	
Adapter, Stirnleuchte	24, 25	
Adapter, Storz	20	
Adapter, Volpi-Schölly-RFO	20	
Adapter, Wolf	20	
Adenotom, LAFORCE	309	
ADSON, anatomische Pinzette	97	
ADSON, chirurgische Pinzette	97	
ADSON, Wundspreizer	112	
ALDERDYCE, Tonsillendissektor	290	
ALM, Wundspreizer	110	
anatomische Pinzette, ADSON	97	
anatomische Pinzette, McINDOE	151	
anatomische Pinzette, POTTS-SMITH	294	
anatomische Pinzette, SEMKEN	95	
ANDERSON-NEIVERT, Osteotom	233	
ANDREW, Zungendrucker	269	
Antihaftpinzetten, bipolare	40, 41	
Antrumhäkchen, PLESTER	137	
Antrumküretten	256, 257	
Antrumkürette, COAKLEY	256	
Antrumkürette, FAULKNER	256	
Antrumlöffel	257	
Antrumraspel, WIENER	238	
Antrumstanze	184, 185	
Antrumstanze, OSTROEM	184	
Arthroskop	15	
ASCH, Septumrichtzange	160	
AUFRICHT, Nasenhaken	251	
AUFRICHT, Nasenraspel	239	
Aufsatz, BARACANI	354	
Aufsatz, BRUENINGS	354	
Aufsatz, CORDES	354	
Aufsatz, FRAENKEL	354	
Aufsatz, KRAUSE	354	
Aufsatz, LANGE	354	
Aufsatz, SCHEINMANN	354	
Aufsatz, SCHUMACHER	354	
Aufsatz, SEIFERT	354	
B		
BABY-METZENBAUM, Supercutschere	188	
BABY-WEBSTER, Nadelhalter	209	
BABY-YANKAUER, Saugrohr	284	
Ball, KABIERSKE	60	
BALLENGER, Schwingmesser	218	
BALLENGER, Septumelevatorium	225	
BALLENGER, Tonsillenzange	281	
BALLENGER-HAJEK, Septumelevatorium	225	
BALLENGER-SLUDER, Tonsillotom	305	
BANE-HARTMANN, Hohlmeißelzange	106	
BARACANI, Aufsatz	354	
BARANY, Lärmtrummel	60	
BARBARA, Häkchen	135, 136	
BARBARA, Nadel	135	
BARNHILL, Ringmesser	308	
BARON, Saugrohr	128	
BARRAQUER, Mikro Nadelhalter	123	
BARSKY, Wundhäkchen	248	
BARTH, scharfer Löffel	104	
Batteriegriffe	332, 333	
BECKMANN, Ringmesser	308	
BELLUCCI, Mikro Ohrschere	80	
BERGMANN, Wundhäkchen	250	
BEUSE, Face-Lift-Schere	201	
BEYER, Hohlmeißelzange	107	
Biegegerät, SCHUHKNECHT	85	
BILLEAU, Ohrschlinge	65	
Biopsie- u. Faßzange, Optiken	15	
Biopsiestanze	179	
Biopsiezange	167	
bipolare Koagulationselektoden	44, 45	
bipolare Pinzetten	36-38, 41	
bipolare Saugpinzette	42	
bipolare Stichkoagulationselektrode	44	
bipolare Verbindungskabel	39	
bipolare Pinzette, antihafte	40, 41	
BLAKESLEY, Nasenzange	164, 168, 180	
Blechscher, UNIVERSAL	118, 299	
Blepharoplastikschere, GREENBERG-PAR	202	
Blepharoplastikschere, KAYE	202	
BLOHMKE, Tonsillenzange	281	
BLUMENTHAL, Hohlmeißelzange	106	
Blutstillungsmeißel, PASSOW	98, 235	
BOEHLER, Hohlmeißelzange	107	
BOETTCHE, Tonsillenschere	296	
Bohrer, HNO	30, 31	
BOIES, Elevatorium	226	
BONN, feine Schere	192	
BOSE, Trachealhaken	315	
BOSE, Trachealwundspreizer	314	
BOUCHERON, Ohrspekula	53	
BOWMAN, Sonde	262, 293	
Brille, FRENZEL	22	
Bronchoskop	18	
Bronchoskopiezange, CHEVALIER-JACKSON	356	
Bronchoskopiezange, JACKSON-CHEVALIER	356	
BRUENINGS, Aufsatz	354	
BRUENINGS, Ohrspekula	55	
BRUENINGS, Septumzange	158	
BRUENINGS, Tonsillennmesser	287	
BRUENINGS, Tonsillenschnürer	301	
BRUENINGS, Verlängerungsrohr	354	
BRUENINGS, Zungenspatel	268	
BRÜNINGS-BRUNK, Wundhaken	263	
BRÜNINGS-LUCAS, Hohlmeißel	98	
Bruststütze, Erwachsene	335	
Bruststütze, Kinder	335	
Bruststütze, LEWY	336	
Bruststütze, NEGUS	280	
BUCHWALD, Zungenspatel	268	
BUCK, Fremdkörperzängchen	73	
BUCK, Ohrkürette	68, 69	
Bügel, McIVOR Mundsperrer	277	
C		
CANFIELD, Tonsillennmesser	287	
CAPLAN, Nasenschere	206	
CARPENTER, Tonsillendissektor	291	

CARPENTER, Tonsillenukleator.....	291	COTTLE, Septumlevatorium	224, 225	DOYEN-JANSEN (MOLT), Mundsperrer.....	271
CASTROVIEJO, Mikro Nadelhalter	124	COTTLE, Septummeißel	231	Draht f. Tonsillenschnürer.....	302, 319
CAWOOD-MINNESOTA, Wangenhalter	268	COTTLE-JOSEPH, Septumlevatorium.....	224	Drahtbiegezüngchen, McGEE.....	81
CHEVALIER-JACKSON, Bronchoskopiezange	356	COTTLE-KAZANJIAN, Knochensplitterzange.....	108, 208	Drahtbiegezüngchen, SCHUHKNECHT	81
CHEVALIER-JACKSON, Trachealkanüle	316	COTTLE-MALTZ, Nasenraspel	239	Drahtschere, UNIVERSAL....	118, 299
chirurgische Pinzette	95	COTTLE-MASING, Nasenschere.....	198	Drahtschlinge, Elektroden	35
chirurgische Pinzette, ADSON.....	97	COTTLE-NEIVERT, Nasenflügelhäkchen.....	252	Drahtschlingen.....	163
chirurgische Pinzette, GILLIES.....	151	CRAIG, Septumzange.....	158	DUCKBILL, Ohrzüngchen	75
chirurgische Pinzette, GRAEFE	95	CRAIG-DOMNICK, Vomerzange..	158	DUPLAY, Tupferzange.....	295
chirurgische Pinzette, POTTS-SMITH	294	CRILE-WOOD, Nadelhalter.....	209	DUPUY-WEISS, Tonsillennadel....	285
chirurgische Pinzette, SEMKEN	95, 151	Cystoskop.....	16	E	
chirurgische Pinzette, STANDARD	95	D		EICKEN (KILLIAN) Spülkanüle....	212
chirurgische Schere, STANDARD	117	DAUBENSPECK, scharfer Löffel..	258	Einsteckkonus, POLITZER.....	61
CINELLI, Septummeißel.....	232	DAVIS-BOYLE, Mundsperrer	274	Elektrode, Koagulation	34, 35
CITELLI, Stanze	109	DAVIS-BOYLE, Zungenspatel	273	Elektrode, bipolar.....	44
CLAR, Stirnlampe.....	26	DAVIS-MEYER, Mundsperrer.....	277	Elektroden	34, 35, 44
CLAUS, Tonsillennadel.....	285	DAY, Wundhäkchen.....	66	Elektroden, monopolar	34, 35
CLAUS-KILLIAN, Septummeißel	236	DEAN, Tonsillenschere.....	296	Elektrodenballkoagulation	35
COAKLEY, Antrumkürette.....	256	Deckelhalter, REICHERT	343	Elektrodendrachtschlinge.....	35
COAKLEY, Trokar.....	215	DENHART, Mundsperrer	271	Elektrodenlanzette.....	35
COLLIN, Zungenzange.....	270	DENIS-BROWNE, Tonsillenzange.....	283	Elektrodennadel Mini	34, 35
Columella-Pinzette, COTTLE	153	DERF, Nadelhalter.....	209	Elektrodennadel, monopolar	35
COLVER, Tonsillenzange	281	DERLACKI, Gehörknöchelpinzette.....	97	Elektrodenschlinge Mini.....	34, 35
CONVERSE, Nasenflügelhäkchen.....	252	Dermatom, HUMBY	221	Elevatorium.....	138
CONVERSE, Nasenmesser	217	Dermatom, SCHINK	220	Elevatorium, BALLENGER.....	225
CONVERSE/WILMER/WALTER, feine Schere	194	Dermatom, SILVER	221	Elevatorium, BALLENGER-HAJEK	225
CORDES, Aufsatz	354	Dermatom, WATSON	221	Elevatorium, BOIES.....	226
COTTLE, Columella-Pinzette	153	Diagnostik-Besteck	48, 50-52	Elevatorium, COTTLE	224
COTTLE, feine Schere	194	DIETER, Hammerkopfstanze	84	Elevatorium, COTTLE-JOSEPH...224	
COTTLE, Fingerringhäkchen.....	255	Dilatator, LABORDE	314	Elevatorium, FREER	91, 223
COTTLE, Fixierpinzette.....	94, 152	Dilatator, RITTER-HALLE.....	261	Elevatorium, GOLDMANN.....	226
COTTLE, Hammer.....	102, 260	Dilatator, TROUSSEAU.....	314	Elevatorium, GOLDMANN.....	226
COTTLE, Knorpelquetscher	237	Dilatator, TROUSSEAU-BABY	314	Elevatorium, GOLDMANN.....	226
COTTLE, Nasenflügelhäkchen	252, 253	DINGMAN, Nasenfeile.....	130	HAJEK-BALLENGER	225
COTTLE, Nasenhaken	251	DINGMAN, Nasenraspel	244	Elevatorium, HALLE	222
COTTLE, Nasenmesser	217	DINGMANN, Mundsperrer.....	276	Elevatorium, HENKE.....	290
COTTLE, Nasenschere	198	DINGMANN, Zungendrücker.....	276	Elevatorium, HOWARTH	224
COTTLE, Nasenspekula.....	146, 147	Dissektor, ALDERYCE.....	290	Elevatorium, JOSEPH.....	222
COTTLE, Osteotom.....	100, 231	Dissektor, CARPENTER.....	291	Elevatorium, JOSEPH-COTTLE...224	
		Dissektor, FISCH.....	93	Elevatorium, KILLIAN	223, 225
		Dissektor, HENKE	290	Elevatorium, LEMPert.....	88
		Dissektor, HURD	290	Elevatorium, MASING	222
		Dissektor, LOPEZ-REINKE	290	Elevatorium, MCKENTY..92, 222, 224	
		DOUGHTY, Zugenspatel	279	Elevatorium, PENNINGTON.....	224
				Elevatorium, PIERCE	223
				Elevatorium, QUERVAIN	86
				Elevatorium, ROGER	222
				Elevatorium, SEBILAU	86
				Elevatorium, SEWALL	226

Elevatorium, SINUS.....	223	feine Schere, WALTER/ WILMER/CONVERSE	194	FROHN, Watteträger	63
Elevatorium, YANKAUER	290	FERGUSSON, Saugrohr	213	FRONTAL, Nasensonde.....	261
Endoskope.....	14-18	FERGUSSON/FRAZIER, Saugrohr.....	125, 213	Führungsgabel, PLESTER	137
Enukleator, CARPENTER	291	FERRIS-SMITH-KERRISON, Stanze	181	FUJI-Kaltlichtkabeladapter	20
Ersatzflasche, KABIERSKE.....	60	Fiberglas-Kaltlichtkabel	19	Fußplattenhäkchen, PLESTER	137
Ersatzklinge, Dermatome	220, 221	Fiberglas-Lichtträger.....	337, 338	G	
Ersatzklingen, LAFORCE	309	Fingerringhäkchen, COTTLE.....	255	GALLAHER, Nasenraspel	243
Ersatzlämpchen..	22, 26, 27, 332, 333	FINSEN, Wundspreizer	110	Gaumenplatte, DAVIS-MEYER	277
Ersatzlämpchen f. FRENZEL	22	FISCH, Dissektor	93	Gehörknöchelpinzette, DERLACKI.....	97
EVES, Tonsillenschnürer	301	FISCH, Mikro Ohrscherer	82	Gelenk, Bruststütze	335
F		FISCH, Wundspreizer.....	112, 265	Gelenkkloben, LEYLA.....	148
Face-Lift-Schere, BEUSE.....	201	FISHER, Tonsillennmesser.....	286	GERZOG, Hammer	259
Face-Lift-Schere, GORNEY	200	Fixierpinzette, COTTLE	94, 152	GILLIES, chirurgische Pinzette....	151
Face-Lift-Schere, GORNEY-FREEMAN	200	Fixierpinzette, GRAEFE	95, 151	GILLIES, Wundhäkchen	254
Face-Lift-Schere, KAYE.....	201	Fixiervorrichtung, YASARGIL	57	GLABELLA, Nasenraspel	238
Face-Lift-Schere, PECK-JOSEPH.....	201	Flachmeißel	98, 99	GOLDMANN, Septumlevatorium.....	226
Fadengabel, Laryngoskopie	352	Flachmeißel, PARTSCH	99	GOOD, Tonsillenschere.....	296
Fadengabel, NEGUS.....	304	Flachmeißel, WALTER	235	GORNEY, Face-Lift-Schere	200
Fadenschere, LITTAUER	199	flexibler Spannarm, YASARGIL	57	GORNEY, Präparierschere	116
Fadenschere, O'BRIEN.....	199	FOMON, Nasenflügelhäkchen.....	253	GORNEY-FREEMAN, Face-Lift-Schere.....	200
Fadenschere, SPENCER.....	199	FOMON, Nasenraspel	240, 241	GRADLE, feine Schere.....	195
FARABEUF, Raspatorium.....	90	FOMON, Nasenschere	198	GRAEFE, chirurgische Pinzette	95
FARRELL, Watteträger	63	FOMON, Septumosteotom	232	GRAEFE, feine Schere.....	194
FARRIOR, Ohrspekula	54	FRAENKEL, Aufsatz.....	354	GRAEFE, Fixierpinzette	95, 151
Faßzängchen, GREVEN	81	FRAENKEL, Kehlkopfzange.....	342	GRAEFE, Wundhäkchen	246
Faßzängchen, Mikro	78	FRAZIER, Wundhäkchen	246	GREENBERG-PAR, Blepharoplastikschere	202
Faßzange, Kieferhöhle	176, 177	FRAZIER/FERGUSSON, Saugrohr.....	125, 213	GREVEN, Faßzängchen	81
Faßzange, LAHEY	318	FREER, Septumlevatorium	91, 223	Griff, HUBER	354
Faßzange f. Optiken	15	FREER, Septummeißel	100, 230, 236	Griff, Kaltlicht	332
FAULKNER, Antrumkürette	256	FREER, Septummesser	216	Griff, Kehlkopfspiegel	346
Feile, DINGMAN	130	FREER, Wundhäkchen	254	Griff, Laryngoskop	336
FEIN, Kehlkopfwatteträger	347	FREER-INGALS, Submukosamesser.....	219	Griff, Warmlicht.....	333
feine Schere, BONN	192	Fremdkörperheber, QUIRE.....	73	Griff, WULLSTEIN	127, 129
feine Schere, CONVERSE/WILMER/WALTER ..	194	Fremdkörperzängchen, BUCK	73	GROSS, Ohrkürette.....	65
feine Schere, COTTLE	194	Fremdkörperzängchen, HARTMANN	75	GROSS, Ohröffel u. -Häkchen.....	65
feine Schere, GRADLE.....	195	Fremdkörperzängchen, HARTMANN-HOFFMANN.....	75, 175	GRUBER, Ohrspekula	53
feine Schere, GRAEFE.....	194	Fremdkörperzängchen, HARTMANN-WEINGÄRTNER	75	GUILEN, Saugraspatorium.....	227
feine Schere, IRIS	117, 192	Fremdkörperzängchen, HARTMANN-WULLSTEIN	75, 175	Gummibirne, POLITZER	61
feine Schere, JOSEPH	116, 190	Fremdkörperzängchen, STRUEMPEL.....	75	GUTHRIE, Wundhäkchen	246
feine Schere, KILNER (RAGNELL)	191	FRENZEL, Nystagmus Brille	22	H	
feine Schere, KNAPP	193	FRENZEL, Zungenspatel	268	HAJEK, Hammer	102
feine Schere, LITTLER.....	194			HAJEK, Septummeißel.....	236
feine Schere, SANVENERO	190			HAJEK-BALLENGER, Septumlevatorium.....	225
feine Schere, STEVENS.....	196			HAJEK-KOFLER, Stanze	182, 183
feine Schere, STRABISMUS	116, 196			Häkchen	25, 66, 135-137, 246-250
feine Schere, WAGNER	197				

Häkchen, BARBARA	135, 136	Hammer, HAJEK	102	Hohlmeißelzange, BOEHLER	107
Häkchen, BARSKY	248	Hammer, MEAD	102, 259	Hohlmeißelzange, KLEINERT-KUTZ	107
Häkchen, BERGMANN	250	Hammer, PARTSCH	102, 260	Hohlmeißelzange, LEMPERS	107
Häkchen, CONVERSE	252	Hammer, QUISLING	260	Hohlmeißelzange, LUER	106
Häkchen, COTTLE	252-255	Hammerkopfstanz, DIETER	84	Hohlmeißelzange, ZAUFAL-JANSEN	107
Häkchen, COTTLE-NEIVERT	252	Handgriff f. Laryngoskope	336	HOLINGER, Laryngoskop	339
Häkchen, DAY	66	Handgriff f. Stabinstrumente, Laryngoskopie	353	HOLZHEIMER, Wundspreizer	110
Häkchen, FOMON	253	HARTMANN, Fremdkörperzängchen	75	Holzspatel	268
Häkchen, FRAZIER	246	HARTMANN, Nasenspekula	142	HOUSE, Mikro Kürette	133
Häkchen, FREER	254	HARTMANN, Nasentamponzange	154	HOUSE, Mikro Meßsonde	132
Häkchen, GILLIES	254	HARTMANN, Ohrkatheter	70	HOUSE, Saugadapter	129
Häkchen, GRAEFE	246	HARTMANN, Ohrspekula	53	HOUSE, Saugrohr	126, 214
Häkchen, GROSS	65	HARTMANN, Ohrzängchen	74	HOUSE-GELFOAM, Quetschzange	85
Häkchen, GUTHRIE	246	HARTMANN, scharfe Nasenzange	169	HOWARTH, Septumlevatorium	224
Häkchen, HUMBY	248	HARTMANN, Stimmgabel	58	HUBER, Universalgriff	354
Häkchen, JOSEPH	247	HARTMANN, Tonsillenzange	307	HUMBY, Dermatom	221
Häkchen, KILNER	253	HARTMANN, Zungendrucker	269	HUMBY, Wundhäkchen	248
Häkchen, KLEINERT-KUTZ	247	HARTMANN-HALLE, Nasenspekula	141	HURD, Tonsillendissektor	290
Häkchen, KNAPP	250	HARTMANN-HOFFMANN, Fremdkörperzängchen	75, 175	I	
Häkchen, Knopf	66	HARTMANN-WEINGÄRTNER, Fremdkörperzängchen	75	IBE+Winter, Adapter	20
Häkchen, LAHEY	246	HARTMANN-WULLSTEIN, Fremdkörperzängchen	75, 175	Injektionskanüle	337, 349
Häkchen, LANGE	255	Hebel, QUIRE	73	IRIS, feine Schere	117, 192
Häkchen, Laryngoskopie	352	Hebel, ZUFAL	65	ITERSON, Trachealhaken	315
Häkchen, LUCAE	66, 250	HEINE-Kaltlichtkabeladapter	20	J	
Häkchen, McGEE	136	HEISTER, Mundsperrerr	271	JACKSON, Kehlkopfpinzette	343
Häkchen Mikro, Laryngoskopie	353	HENKE, Tonsillendissektor	290	JACKSON, Laryngoskope	340
Häkchen, NEIVERT-COTTLE	252	HENKE, Tonsillenelevatorium	290	JACKSON, Trachealhaken	314
Häkchen, PLESTER	137	HEYMANN, Nasenschere	198	JACKSON-CHEVALIER, Bronchoskopiezange	356
Häkchen, REDA	249	HEYMANN, Septumzange	157	JAMESON-REYNOLDS, Schere	191
Häkchen, ROLLET	250	HEYMANN-KNIGHT, Polypenzange	156	JANSEN, Nasentamponpinzette	150
Häkchen, SHAMBAUGH	135	HNO-Bohrer	30, 31	JANSEN, Raspatorium	91
Häkchen, TYRELL	246	HOFER, Wundhaken	289	JANSEN, scharfer Löffel	103
Häkchen, WAGENER	66	Hohlmeißel	98, 99	JANSEN, Wundspreizer	110
Häkchen, WILLIGER	114	Hohlmeißel, BRÜNING-S-LUCAS	98	JANSEN-MIDDLETON, Septumzange	159
Haken, AUFRICHT	251	Hohlmeißel, FREER	236	JANSEN-ZAUFAL, Ohrhebel	65
Haken, BOSE	315	Hohlmeißel, LEXER MINI	100	JATHO, Nasenrachenzange	310
Haken, COTTLE	251	Hohlmeißel, PARTSCH	99	JENNINGS, Mundsperrerr	271
Haken, ITERSON	315	Hohlmeißelzange, BANE-HARTMANN	106	JOBSON-HORNE, Watteträger	64
Haken, JACKSON	314	Hohlmeißelzange, BEYER	107	JOSEPH (LEWIS), Nasenraspel	239
Haken, MASING	251	Hohlmeißelzange, BLUMENTHAL	106	JOSEPH, Elevatorium	222
Haken, MASING-NEIVERT	251			JOSEPH, feine Schere	116, 190
Haken, NEIVERT-MASING	251			JOSEPH, Nasenmesser	216, 217
Haken, NEWS	315			JOSEPH, Nasenraspel	238
Haken, SCHOENBORN	317			JOSEPH, Nasensäge	244, 245
HALLE, scharfer Löffel	104, 258			JOSEPH, Raspatorium	88
HALLE, Septumlevatorium	222				
HALLE-RITTER, Nasensonde	261				
HALSEY, Nadelhalter	209				
Haltearm, LEYLA	148				
Hammer	102, 259, 260				
Hammer, COTTLE	102, 260				
Hammer, GERZOG	259				

JOSEPH, Wundhäkchen	247	KILLIAN, Kehlkopfwatteträger	347	KRAUSE, Aufsatz	354
JOSEPH-COTTLE, Septumelevatorium.....	224	KILLIAN, Nasenspekula	144, 145	KRAUSE, Polypenschnürer.....	72, 162
JURASZ, Kehlkopfzange.....	342	KILLIAN, Septumelevatorium	223, 225	KRAUSE-VOSS, Polypenschnürer.....	162
JURASZ, Nasenrachenzange	311	KILLIAN, Spülkanüle	212	KROENIG, Zungenspatel	268
K		KILLIAN-CLAUS, Septummeißel.....	236	Kropffaßzange, LAHEY	318
Kabel, bipolar.....	39	KILLIAN-EICKEN, Spülkanüle.....	212	Kropfsonde, KOCHER.....	317
KABIERSKE, Ersatzflasche.....	60	KILNER (RAGNELL), feine Schere	191	Kugelelektrode.....	35
KABIERSKE, Ohrkanüle.....	60	KILNER, Nasenflügelhäkchen.....	253	Kugelgelenkkloben, LEYLA.....	148
KABIERSKE, Pulverbläser	60	KILNER-DOUGHTY, Mundsperrer	275	Kupplungskopf, LEYLA.....	148
KABIERSKE, Ventilball.....	60	KLEINERT-KUTZ, Hohlmeißelzange.....	107	Kürette, Antrum.....	256, 257
Kaltlichtkabel, Fiberglas.....	19	KLEINERT-KUTZ, Wundhäkchen.....	247	Kürette, BUCK.....	68, 69
Kaltlichtgriff	332	Kleintransformator	26	Kürette, COAKLEY	256
Kaltlichtkabeladapter	20	Klemme, BOETTCHER (SCHNIDT).....	281	Kürette, FAULKNER.....	256
Kaltlichtkabeladapter, ACM.....	20	Klemme, MASTIN.....	318	Küretten, HOUSE	133
Kaltlichtkabeladapter, Fuji.....	20	Klemme, MIKULICZ.....	283	L	
Kaltlichtkabeladapter, Heine	20	Klemme, NEGUS.....	281	LABORDE, Trachealdilatator.....	314
Kaltlichtkabeladapter, MLW	20	Klemme, SAWTELL.....	281	LAFORCE, Adenotom	309
Kaltlichtkabeladapter, Olympus	20	Klemme, SCHNIDT	281	LAHEY, Kropffaßzange.....	318
Kaltlichtkabeladapter, Pentax	20	Klemme, SCHNIDT (BOETTCHER).....	281	LAHEY, Wundhäkchen	246
Kaltlichtkabeladapter, Wolf	20	KNAPP, feine Schere.....	193	LAMBOTTE Mini, Osteotom	99, 229
Kanüle, CHEVALIER-JACKSON	316	KNAPP, Wundhäkchen.....	250	Lämpchen.....	22, 26, 27, 332, 333
Kanüle, EICKEN (KILLIAN).....	212	KNIGHT, Septumzange	157	LANGE, Aufsatz.....	354
Kanüle, Injektion	337, 349	Knochendraht	302	LANGE, Nasenflügelhäkchen.....	255
Kanüle, Kehlkopf	210, 306, 344	Knochensplitterzange, COTTLE-KAZANJIAN	108, 208	LANGENBECK, Ohrschlinge.....	65
Kanüle, KILLIAN	212	Knochensplitterzange, McINDOE	108, 208	LANGENBECK, Raspatorium.....	86
Kanüle, KILLIAN-EICKEN	212	Knochenstanze, CITELLI.....	109	Lanzette, Elektrode.....	35
Kanüle, LUER.....	316	Knochenstanze, FERRIS-SMITH-KERRISON	181	Lanzettenmesser, ROSEN	121
Kanüle, Mikro.....	125, 127	Knochenstanze, KERRISON.....	109	Laparoskop	18
Kanüle, Ohr, KABIERSKE	60	Knopfhäkchen.....	66	Lärmtrommel, BARANY.....	60
Kanüle, ROSEN.....	129	Knorpelfeile, DINGMAN.....	130	Laryngoskop, HOLINGER	339
Kanüle, Septum.....	210, 306, 344	Knorpelquetscher, COTTLE	237	Laryngoskop, JACKSON	340
Kanüle, WAGENER-MOSHER.....	315	Knorpelritzmesser, MASING.....	219	Laryngoskope	17, 334-336, 339-341
Katheter, HARTMANN.....	70	Koagulationselektrode, bipolar	44, 45	Laryngoskope Handgriff	336
KAYE, Blepharoplastikschere.....	202	Koagulationselektrode Mini	35	Laryngoskopie Instrumente	352, 353
KAYE, Face-Lift-Schere	201	Koagulationssaugrohr.....	211, 348	Laryngoskopie, Injektionskanüle	337
Kehldeckelhalter, REICHERT.....	343	KOCHER, Kropfsonde.....	317	Laryngoskopie, Nadelhalter.....	349
Kehlkopfkanüle	210, 306, 344	KOCHER-LANGENBECK, Wundhaken	263	Laryngoskop-Optik	17
Kehlkopfpinzette, JACKSON.....	343	KOENIG, Raspatorium	86	Laryngoskop-Set	322, 325, 327, 329
Kehlkopfpolypenschnürer.....	319	KOFLER-HAJEK, Stanze	182	Laryngoskop-Spatel, McCOY	324, 331
Kehlkopfschere, KILLIAN	343	Kornzange	295	Laryngoskop-Spatel, McINTOSH	323, 328
Kehlkopfspiegel	346	Kornzange, DUPLAY	295	Laryngoskop-Spatel, MILLER	326, 330
Kehlkopfspiegel, MICHEL.....	345			LED-Stirnlampe	27
Kehlkopfwatteträger, FEIN.....	347			LEMPERT, Elevatorium	88
Kehlkopfwatteträger, KILLIAN	347			LEMPERT, Hohlmeißelzange	107
Kehlkopfzange, FRAENKEL.....	342			LEMPERT, Raspatorium.....	88, 91
Kehlkopfzange, JURASZ.....	342			LEMPERT, scharfer Löffel	103
KELLY, Präparierschere	191			Leuchtklammer.....	338, 341
KERRISON, Stanze.....	109, 182				
Kieferhöhlenfaßzange	176, 177				
KILLIAN, Kehlkopfschere	343				

LEWIS-JOSEPH, Nasenraspel.....	239	M	Messer, FREER.....	216
LEWY, Bruststütze.....	336	MALTZ (COTTLE), Nasenraspel ..	Messer, FREER-INGALS	219
LEXER Mini, Hohlmeißel	100	MALTZ, Nasenraspel.....	Messer, JOSEPH.....	216, 217
LEXER Mini, Osteotom.....	100	MARSCHIK, Tonsillenzange.....	Messer, MASING.....	219
LEXER, Osteotom	100, 228	MARTIN, Verbindungskabel,	Messer Mikro,	
LEYLA, Gelenkkloben	148	bipolar	Laryngoskopie	352, 353
LEYLA, Haltearm.....	148	MARTINI, scharfer Löffel	Messer, PLESTER.....	122
LEYLA, Kugelgelenkkloben.....	148	MASING, Elevatorium	Messer, POLITZER	71
LEYLA, Kupplungskopf.....	148	MASING, Knorpelritzmesser	Messer, REDA.....	217
Lichtträger, Fiberglas.....	337, 338	MASING, Nasenhaken	Messer, ROSEN.....	120, 121
LICHTWITZ, Trokar	215	MASING, Nasenraspel	Messer, SCHUKNECHT	122
LINDEMANN, Nasensäge	245	MASING-NEIVERT,	Messer, SEXTON	71
Lippenhalter.....	270	Nasenhaken.....	Messer, St. CLAIR-THOMSON ...	309
LISTER (Sinus), Tamponzange....	155	MASTIN, Muskelklemme.....	Messer, TABB.....	122
LITTAUER, Fadenschere	199	MAUNDER, Mundkeil.....	Messer, WULLSTEIN	122
LITTAUER, Ohrzängchen.....	74	MAY, Ophthalmoskop	Meißsonde Mikro, HOUSE	132
LITTAUER, Polypenzange.....	156	McCOY,	METZENBAUM,	
LITTLER, feine Schere.....	194	Laryngoskopspatel	Präparierschere	115, 188, 189, 297
Löffel.....	138	McGEE, Drahtbiegezängchen.....	MICHEL, Kehlkopfspiegel.....	345
Löffel, Antrum	257	McGEE, Häkchen.....	MICRODOME,	
Löffel, BARTH.....	104	McINDOE,	Koagulationselektrode bipolar	45
Löffel, DAUBENSPECK.....	258	anatomische Pinzette	MIDDELDORPF, Wundhaken.....	263
Löffel, GROSS.....	65	McINDOE,	MIDDLETON-JANSEN,	
Löffel, HALLE	104, 258	Knochensplitterzange.....	Septumzange	159
Löffel, JANSEN.....	103	McINTOSH, Laryngoskop-Set.....	Mikro Faßzängchen.....	78
Löffel, LEMPERT	103	327	Mikro Häkchen, Laryngoskopie ...	353
Löffel, MARTINI	105	McINTOSH,	Mikro Löffelzängchen,	
Löffel, SHEA	134	Laryngoskopspatel	WULLSTEIN.....	79
Löffel, SPRATT.....	103	McIVOR, Mundsperrerr.....	Mikro Löffelzange	131
Löffel, VOLKMANN.....	104	McIVOR, Zungenspatel	Mikro Messer, Laryngoskopie.....	353
Löffel, WILLIGER.....	105	McKENTY,	Mikro Nadelhalter,	
Löffelzängchen Mikro,		Septumelevatorium.....	BARRAQUER.....	123
WULLSTEIN	79	MEAD, Hammer	Mikro Nadelhalter,	
Löffelzange Mikro	131	Meißel.....	CASTROVIEJO	124
LOPEZ-REINKE,		Meißel, CINELLI	Mikro Nadelhalter, TITAN	123
Tonsillendissektor	290	Meißel, CLAUS-KILLIAN	Mikro Ohrscherchen,	
LOTHROP, Uvulahaken.....	288	Meißel, FREER.....	WULLSTEIN	83
LOVE, Uvulahaken	288	Meißel, HAJEK	Mikro Ohrscherre, BELLUCCI	80
LUBET-BARBON,		Meißel, KILLIAN-CLAUS	Mikro Ohrscherre, SHEA	80
Nasentamponzange	154	Meißel, PASSOW	Mikro Ohrscheren.....	80, 82, 83, 131
LUC, Siebbeinzange.....	157	Meißel, SILVER	Mikro Ohrzängchen	76, 77
LUCAE, Ohr-Nasen-Pinzette..	94, 152	Meißel, WALTER	Mikro Ohrzange.....	131
LUCAE, Stimmgabel.....	59	Meißel, WEST	Mikro Rohrschaftzange.....	350, 351
LUCAE, Trommelfellnadel	70	Messer, ABRAHAM	Mikro Sichelmesser,	
LUCAE, Wundhäkchen.....	66, 250	Messer, BALLENGER	Laryngoskopie	352
LUER, Hohlmeißelzange	106	Messer, BARNHILL	Mikro Kürette, HOUSE	133
LUER, Trachealkanüle.....	316	Messer, BECKMANN.....	Mikro Meißsonde, HOUSE.....	132
Luftdusche, POLITZER	61	Messer, BRUENINGS.....	Mikro Ohrzängchen	75-81
LUNIATSCHEK, Tamponstopfer...292		Messer, CANFIELD	Mikro Saugkanüle.....	125, 127
Lupe, BRUENINGS	55	Messer, CONVERSE.....	Mikro Schere, REDA.....	203
		Messer, COTTLE.....	Mikro Scheren	119, 203-205
		Messer, FISHER.....	Mikro Scheren, TITAN	203-205

MIKULICZ, Tonsillenklemme	283	Nasenhäkchen, CONVERSE	252	Nasenschere, HEYMANN	198
MILLER, Laryngoskop-Set ...	325, 329	Nasenhäkchen, COTTLE	252-254	Nasensonde, FRONTAL	261
MILLER, Laryngoskopspatel		Nasenhäkchen,		Nasensonde, RITTER-HALLE	261
.....	326, 330	COTTLE-NEIVERT	252	Nasensonde, SINUS	261
MILLER, Raspatorium	92	Nasenhäkchen, FOMON	253	Nasensonde, WILDER	261
Miniatur-Stirnleuchte	23	Nasenhäkchen, KILNER	253	Nasenspekula	140-147
MINI-LAMBOTTE, Osteotom ..	99, 229	Nasenhäkchen, LANGE	255	Nasenspekula, COTTLE	146, 147
MLW-Kaltlichtkabeladapter	20	Nasenhäkchen,		Nasenspekula, HARTMANN	142
Mod. VIENNA, Nasenspekula	143	NEIVERT-COTTLE	252	Nasenspekula,	
MOLLISON, Wundsperrler	112	Nasenhaken, AUFRICHT	251	HARTMANN-HALLE	141
MOLT, Mundsperrler	271	Nasenhaken, COTTLE	251	Nasenspekula, KILLIAN	144, 145
MOLT, Raspatorium	92	Nasenhaken,		Nasenspekula, REDA	144
MORITZ-SCHMIDT,		MASING-NEIVERT	251	Nasenspekula, THUDICHUM	140
Zungendrucker	269	Nasenhaken,		Nasenspekula, TIECK-HALLE	144
Mundkeil, MAUNDER	280	NEIVERT-MASING	251	Nasenspekula, VIENNA	143
Mundsperrler, DAVIS-BOYLE	274	Nasenmesser, CONVERSE	217	Nasenspekula, VOLTOLINI	140
Mundsperrler, DAVIS-MEYER	277	Nasenmesser, COTTLE	217	Nasentamponzange,	
Mundsperrler, DENHART	271	Nasenmesser, JOSEPH	216, 217	HARTMANN	154
Mundsperrler, DINGMANN	276	Nasen-Ohr-Pinzette, LUCAE ..	94, 152	Nasentamponzange,	
Mundsperrler, DOYEN-JANSEN ..	271	Nasenolive, POLITZER	61	LUBET-BARBON	154
Mundsperrler, HEISTER	271	Nasenpinzette, LUCAE	94, 152	Nasentamponzange,	
Mundsperrler, JENNINGS	271	Nasenpinzette,		WESTMACOTT	154
Mundsperrler,		TROELTSCH-WILDE	94, 152	Nasentamponzinzette, JANSEN ..	150
KILNER-DOUGHTY	275	Nasenpinzette, WILDE		Nasentamponzinzette,	
Mundsperrler, McIVOR	277	(TROELTSCH)	94, 152	TROELTSCH	149
Mundsperrler, MOLT	271	Nasenrachenzange, JATHO	310	Nasenzange, ASCH	160
Mundsperrler, ROSER-KOENIG ..	271	Nasenrachenzange, JURASZ	311	Nasenzange, Biopsie	167
Muskelklemme, MASTIN	318	Nasenrachenzange,		Nasenzange, BLAKESLEY ..	164, 168
		St. CLAIR-THOMSON	310	Nasenzange, durchschneidend ..	178
		Nasenraspel , MALTZ (COTTLE) ..	239	Nasenzange, HARTMANN	169
		Nasenraspel, (JOSEPH (LEWIS) ..	239	Nasenzange, SCHMEDEN	169
		Nasenraspel, AUFRICHT	239	Nasenzange, STRUYCKEN	169
		Nasenraspel, COTTLE-MALTZ ..	239	Nasenzange, TAKAHASHI	165
		Nasenraspel, DINGMAN	244	Nasenzange, WALSHAM	160
		Nasenraspel, FOMON	240, 241	Nasenzange,	
		Nasenraspel, GALLAHER	243	WATSON-WILLIAMS	166
		Nasenraspel, GLABELLA	238	Nasenzange,	
		Nasenraspel, JOSEPH	238	WEIL-BLAKESLEY	164, 168
		Nasenraspel, LEWIS-JOSEPH	239	Nasenzangen	169-174
		Nasenraspel, MALTZ	238	Nasopharyngo-Laryngoskop	14
		Nasenraspel, MASING	242	NEGUS, Bruststütze	280
		Nasenraspel, PARKES	238	NEGUS, Fadengabel	304
		Nasensäge, JOSEPH	244, 245	NEGUS, Tonsillenklemme	281
		Nasensäge, LINDEMANN	245	NEIVERT-ANDERSON,	
		Nasenschere, CAPLAN	206	Osteotom	233
		Nasenschere,		NEIVERT-COTTLE,	
		COTTLE-MASING	198	Nasenflügelhäkchen	252
		Nasenschere,		NEIVERT-MASING,	
		MASING-COTTLE	198	Nasenhaken	251
		Nasenscheren	187	NEWS, Trachealhaken	315
		Nasenschere, COTTLE	198	Non-Stick, Saugkoagulator,	
		Nasenschere, FOMON	198	monopolar	43

NOYES, Polypenzange	155	Ohrzängchen, WULLSTEIN	79	Pinzette, JANSEN	150
Nystagmus Brille, FRENZEL	22	Ohrzange Mikro	131	Pinzette, LUCAE	94, 152
O		Olympus-Kaltlichtkabeladapter	20	Pinzette, McINDOE	151
O'BRIEN, Fadenschere	199	Ophthalmologie Schere	195	Pinzette, POTTS-SMITH	294
OBWEGESER, Osteotom	234	Ophthalmoskop, MAY	49	Pinzette, SEMKEN	95, 151
Ohrhäkchen	66	Ophthalmoskop, UNI II	49	Pinzette, TROELTSCH	149
Ohrhäkchen, DAY	66	OP-Laryngoskope	334-336, 341	Pinzette,	
Ohrhäkchen, GROSS	65	Osteotom	98	TROELTSCH-WILDE	94, 152
Ohrhäkchen, WAGENER	66	Osteotom,		Pinzette, WILDE	
Ohrhebel, JANSEN-ZAUFAL	65	ANDERSON-NEIVERT	233	(TROELTSCH)	94, 152
Ohrhebel, ZAUFAL	65	Osteotom, COTTLE	100, 231	Pinzette, bipolar	36-38, 40, 41
Ohrhebel, ZAUFAL-JANSEN	65	Osteotom, FOMON	232	Pinzette, COTTLE	94, 152, 153
Ohrkanüle, KABIERSKE	60	Osteotom, LEXER	228	Pinzette, Uhrmacher	96
Ohrkatheter, HARTMANN	70	Osteotom, LEXER MINI	100	PLESTER, Antrumhäkchen	137
Ohrkürette, BUCK	68, 69	Osteotom, MINI-LAMBOTTE	99, 229	PLESTER, Führungsgabel	137
Ohrkürette, GROSS	65	Osteotom,		PLESTER, Fußplattenhäkchen	137
Ohrlöffel, GROSS	65	NEIVERT-ANDERSON	233	PLESTER, Rundmesser	122
Ohrmesser, POLITZER	71	Osteotom, OBWEGESER	234	PLESTER, Saugrohr	126
Ohrmesser, SEXTON	71	Osteotom, RUBIN	234	PLESTER, Schaber	137
Ohr-Nasen-Pinzette, LUCAE	94, 152	Osteotom, SHEEHAN	101, 232	PLESTER, Wundspreizer	113, 264
Ohrolive, POLITZER	61	Osteotom, OSTROEM, Antrumstanze	184	POLITZER, Einsteckkonus	61
Ohrpinzette,		Otoskop	17, 48	POLITZER, Gummibirne	61
TROELTSCH-WILDE	94, 152	Otoskop,		POLITZER, Luftdusche	61
Ohrpinzette,		Diagnostik-Besteck UNI I	48	POLITZER, Nasenolive	61
WILDE (TROELTSCH)	94, 152	Otoskop,		POLITZER, Ohrmesser	71
Ohrschere Mikro, BELLUCCI	80	Diagnostik-Besteck UNI III	50	POLITZER, Ohrolive	61
Ohrschere Mikro, SHEA	80	P		POLITZER, Ohrspekula	53
Ohrschere, FISCH	82	PARKES, Nasenraspel	238	POLITZER, Trommelfellnadel	70, 71
Ohrscheren Mikro	80, 82, 83, 131	PARTSCH, Flachmeißel	99	Polypenschnürer, Kehlkopf	319
Ohrschlinge, BILLEAU	65	PARTSCH, Hammer	102, 260	Polypenschnürer, KRAUSE	72, 162
Ohrschlinge, LANGENBECK	65	PARTSCH, Hohlmeißel	99	Polypenschnürer,	
Ohrschlinge, SHAPLEIGH	67	PASSOW,		KRAUSE-VOSS	162
Ohrschlinge, WEBER-LOCH	67	Blutstillungsmeißel	98, 235	Polypenschnürer,	
Ohrsonde, STACKE	63	PECK-JOSEPH,		VOSS-KRAUSE	162
Ohrspekula, BRUENINGS	55	Face-Lift-Schere	201	Polypenschnürer, WILDE	72, 163
Ohrspekula, FARRIOR	54	PEET, Nasenraspel	238	Polypenzange, FRAENKEL	342
Ohrspekula, GRUBER	53	PENNINGTON,		Polypenzange, JURASZ	342
Ohrspekula, HARTMANN	53	Septumelevatorium	224	Polypenzange,	
Ohrspekula, POLITZER	53	Pentax-Kaltlichtkabeladapter	20	KEYMANN-KNIGHT	156
Ohrspekula, SIEGLE	56	PERWITZSCHKY,		Polypenzange, LITTAUER	156
Ohrspekula, TOYNBEE	53	Speichelgangschere	298	Polypenzange, NOYES	155
Ohrspekula, BOUCHERON	53	Pharyngoskop	16	POTTS-SMITH,	
Ohrspekulahalter, YASARGIL	57	PIERCE, Septumelevatorium	223	anatomische Pinzette	294
Ohrspritze	61, 62	Pinzette, ADSON	97	POTTS-SMITH,	
Ohrspritze, REINER	61	Pinzette, anatomisch	95	chirurgische Pinzette	294
Ohrspritze, selbstfüllend	62	Pinzette, chirurgisch	95	Präparierschere, GORNEY	116
Ohrtrichterhalter, YASARGIL	57	Pinzette, COTTLE	153	Präparierschere, KELLY	191
Ohrzängchen Mikro	75-81	Pinzette, DERLACKI	97	Präparierschere,	
Ohrzängchen, DUCKBILL	75	Pinzette, GILLIES	151	METZENBAUM	115, 188, 189, 297
Ohrzängchen, HARTMANN	74	Pinzette, GRAEFE	95, 151	Präparierschere,	
Ohrzängchen, LITTAUER	74	Pinzette, JACKSON	343	REYNOLDS (JAMESON)	191
				PRINCE, Tonsillenschere	296

Pulverbläser, KABIERSKE	60	REDA, Wundhäkchen.....	249	Saugrohr, HOUSE	126, 214
Pulverbläser, UNIVERSAL	60	REICHERT, Kehldeckelhalter	343	Saugrohr, Koagulation	211, 348
Q					
QUERVAIN, Elevatorium	86	REINER, Ohrspritze	61	Saugrohr, PLESTER.....	126
Quetschzange,		REYNOLDS (JAMESON),		Saugrohr, ROSEN	129
HOUSE-GELFOAM	85	Präparierschere	191	Saugrohr, WULLSTEIN	127
Quetschzange, RUBIN	161	RFO-Schölly-Volpi, Adapter	20	Saugrohr, YANKAUER	284
QUIRE, Fremdkörperhebel.....	73	Ring f. Bruststütze	335	Saugrohr, ZÖLLNER	125
QUISLING, Hammer.....	260	RING, Zungenspatel.....	272	Saugrohre.....	125-129
R					
RAGNELL-KILNER,		Ringmesser, BARNHILL	308	SAWTELL, Tonsillenklemme	281
feine Schere	191	Ringmesser, BECKMANN	308	Schaber, PLESTER	137
Rasierklingen.....	221	Ringmesser,		Schälmesser Mikro,	
Raspatorien	86-92, 138, 227	St. CLAIR-THOMSON	309	Laryngoskopie	352
Raspatorien, Ferrozellgriff	89	RITTER-HALLE, Nasensonde.....	261	scharfe Nasenzange,	
Raspatorium, FARABEUJ	90	ROEDER, Tonsillenschnürer	303	SCHMEDEN	169
Raspatorium, GUILLEN.....	227	ROGER, Septumlevatorium	222	scharfe Nasenzange,	
Raspatorium, JANSEN	91	Rohr, BRUENINGS	354	TAKAHASHI	165
Raspatorium, JOSEPH.....	88	Rohrschaftzange Mikro.....	350, 351	scharfe Nasenzange,	
Raspatorium, KOENIG	86	ROLLET, Wundhäkchen	250	WATSON-WILLIAMS.....	166
Raspatorium, LANGENBECK.....	86	ROSEN, Lanzettenmesser	121	scharfe Nasenzangen....	165, 169-174
Raspatorium, LEMPERT	88	ROSEN, Messer.....	120, 121	scharfe Nasenzangen,	
Raspatorium, MILLER	92	ROSEN, Nadel	136	HARTMANN	169
Raspatorium, MOLT	92	ROSEN, Raspatorium	93	scharfer Löffel, BARTH.....	104
Raspatorium, ROSEN	93	ROSEN, Saugrohr.....	129	scharfer Löffel, DAUBENSPECK..	258
Raspatorium z. Saugen,		ROSER-KOENIG, Mundsperrer ...	271	scharfer Löffel, HALLE	104, 258
Laryngoskopie	353	ROUX-BABY, Wundhaken.....	263	scharfer Löffel, JANSEN.....	103
Raspatorium, WILLIGER	87	RUBIN, Osteotom.....	234	scharfer Löffel, LEMPERT	103
Raspatorium, WULLSTEIN.....	92	RUBIN, Septumquetschzange....	161	scharfer Löffel, MARTINI	105
Raspel, AUFRICHT	239	Rundmesser, PLESTER.....	122	scharfer Löffel, SHEA	134
Raspel, COTTLE-MALTZ	239	RUSSEL-DAVIS, Zungenspatel....	278	scharfer Löffel, SPRATT.....	103
Raspel, DINGMAN	244	RYDEL-SEIFFERT, Stimmgabel ...	59	scharfer Löffel, VOLKMANN.....	104
Raspel, FOMON	240, 241	S			
Raspel, GALLAHER	243	Säge, JOSEPH.....	244, 245	scharfer Löffel, WILLIGER.....	105
Raspel, GLABELLA	238	Säge, LINDEMANN	245	SCH EINMANN, Aufsatz.....	354
Raspel, JOSEPH	238	SANVENERO, feine Schere.....	190	Scherchen Mikro, WULLSTEIN	83
Raspel, JOSEPH (LEWIS)	239	Sattelhäkchen, COTTLE.....	252	Schere, BABY-METZENBAUM ...	188
Raspel, LEWIS-JOSEPH.....	239	Saugadapter, HOUSE	129	Schere, BELLUCCI.....	80
Raspel, LEWIS-JOSEPH.....	239	Saugball, BRUENINGS	55	Schere, BEUSE	201
Raspel, MALTZ	238	Sauggriff, WULLSTEIN.....	127, 129	Schere, BOETTCHER.....	296
Raspel, MALTZ (COTTLE)	239	Saugkanüle Mikro.....	125, 127	Schere, BONN.....	192
Raspel, MASING	242	Saugkoagulator,		Schere, CAPLAN.....	206
Raspel, PARKES	238	Non-Stick, monopolar	43	Schere, chirurgisch,	
Raspel, PEET	238	Saugpinzette, bipolar.....	42	STANDARD	117
Raspel, WIENER	238	Saugraspatorium, GUILLEN.....	227	Schere, CONVERSE/	
Rauchabsaugrohr.....	338	Saugraspatorium,		WILMER/WALTER.....	194
REDA, Mikro Schere	203	Laryngoskopie	353	Schere, COTTLE.....	194, 198
REDA, Nasenspekula.....	144	Saugrohr.....	126, 348	Schere, COTTLE-MASING.....	198
REDA, Sichelmesser	217	Saugrohr, BABY-YANKAUER.....	284	Schere, DEAN	296
REDA, Stimmgabel.....	58	Saugrohr, BARON	128	Schere, FISCH	82
REDA, Watteträger.....	64	Saugrohr, FERGUSON	213	Schere, FOMON.....	198
		Saugrohr,		Schere, GOOD	296
		FRAZIER/FERGUSON	125, 213	Schere, GORNEY.....	116, 200
				Schere, GORNEY-FREEMAN	200
				Schere, GRADLE	195

Schere, GRAEFE	194	Schnürer, BRUENINGS	301	Septummeißel, COTTLE	231
Schere, GREENBERG-PAR	202	Schnürer, EVES	301	Septummeißel, FOMON	232
Schere, HEYMANN	198	Schnürer, KRAUSE	162	Septummeißel, FREER	100, 230, 236
Schere, IRIS	117, 192	Schnürer, KRAUSE-VOSS	162	Septummeißel, HAJEK	236
Schere, JOSEPH	116, 190	Schnürer, ROEDER	303	Septummeißel, KILLIAN-CLAUS	236
Schere, KAYE	201, 202	Schnürer, VOSS-KRAUSE	162	Septummeißel, SHEEHAN	232
Schere, KELLY	191	Schnürer, WILDE	163	Septummeißel, SILVER	233
Schere, KILLIAN	343	SCHOENBORN, Schilddrüsenhaken	317	Septummeißel, WEST	236
Schere, KILNER (RAGNELL)	191	Schölly-Volpi-RFO, Adapter	20	Septummesser, COTTLE	217
Schere, KNAPP	193	SCHUHKNECHT, Biegegerät	85	Septummeißel, FREER	216
Schere, LITTAUER	199	SCHUHKNECHT, Drahtbiegezängchen	81	Septumosteotom, COTTLE	231
Schere, LITTLER	194	SCHUKNECHT, Messer	122	Septumosteotom, FOMON	232
Schere, MASING-COTTLE	198	SCHUKNECHT, Sichelmesser	122	Septumosteotom, SHEEHAN	101, 232
Schere, METZENBAUM	115, 188, 189, 297	SCHUMACHER, Aufsatz	354	Septumquetschzange, RUBIN	161
Schere, O'BRIEN	199	Schwingmesser, BALLENGER	218	Septumrichtzange, ASCH	160
Schere, Ophthalmologie	195	SEBILEAU, Elevatorium	86	Septumrichtzange, WALSHAM	160
Schere, PECK-JOSEPH	201	SEIFERT, Aufsatz	354	Septumzange, BRUENINGS	158
Schere, PERWITZSCHKY	298	SEIFFERT-RYDEL, Stimmgabel	59	Septumzange, CRAIG	158
Schere, PRINCE	296	SEMKEN, anatomische Pinzette	95	Septumzange, HEYMANN	157
Schere, REDA	203	SEMKEN, chirurgische Pinzette	95, 151	Septumzange, JANSEN-MIDDLETON	159
Schere, REYNOLDS (JAMESON)	191	Septumelevatorium, BALLENGER	225	Septumzange, KNIGHT	157
Schere, SANVENERO	190	Septumelevatorium, BALLENGER-HAJEK	225	Septumzange, MIDDLETON-JANSEN	159
Schere, SHEA	80	Septumelevatorium, COTTLE	224, 225	Set, Laryngoskope	322, 325, 327, 329
Schere, SPENCER	199	Septumelevatorium, COTTLE-JOSEPH	224	SEWALL, Elevatorium	226
Schere, STEVENS	196	Septumelevatorium, FREER	91, 223	SEXTON, Ohrmesser	71
Schere, STRABISMUS	116, 196	Septumelevatorium, GOLDMANN	226	SHAMBAUGH, Häkchen	135
Schere, Tumor	207	Septumelevatorium, HAJEK-BALLENGER	225	SHAPLEIGH, Ohrschlinge	67
Schere, UNIVERSAL	118, 299	Septumelevatorium, HALLE	222	SHEA, Mikro Ohrschere	80
Schere, WAGNER	197	Septumelevatorium, HOWARTH	224	SHEA, scharfer Löffel	134
Schere, WILMER/ WALTER/CONVERSE	194	Septumelevatorium, JOSEPH-COTTLE	224	SHEEHAN, Septumosteotom	101, 232
Schere Mikro	119, 203-205	Septumelevatorium, KILLIAN	223, 225	Sichelmesser	121, 122
Schere, Nase	187	Septumelevatorium, McKENTY	92, 222, 224	Sichelmesser Mikro, Laryngoskopie	352
Schere, Ohr	80, 82, 83, 131	Septumelevatorium, PENNINGTON	224	Sichelmesser, REDA	217
Schere, TITAN	203-205	Septumelevatorium, PIERCE	223	Sichelmesser, SCHUKNECHT	122
Schilddüsenhaken, SCHOENBORN	317	Septumelevatorium, ROGER	222	Sichelmesser, WULLSTEIN	122
SCHINK, Dermatome	220	Septumelevatorium, SINUS	223	Siebbeinzange, LUC	157
Schlinge, BILLEAU	65	Septumelevatorium, SILVER	221	Siebbeinzange, TAKAHASHI	165
Schlinge, Elektrode Mini	34, 35	Septumkanüle	210, 306, 344	Siebbeinzange, WEIL-BLAKESLEY	164
Schlinge, LANGENBECK	65	Septummeißel, CINELLI	232	Siebbeinzangen, WATSON-WILLIAMS	166
Schlinge, SHAPLEIGH	67	Septummeißel, CLAUS-KILLIAN	236	SIEGLE, Ohrspekula	56
Schlinge, WEBER-LOCH	67			Silikonschlauch f. McIVOR Mundsperrer	277
Schlingen, Polypenschnürer	72			SILVER, Dermatome	221
SCHMEDEN, scharfe Nasenzange	169				
SCHNIDT (BOETTCHER), Tonsillenklemme	281				
SCHNIDT, Tonsillenklemme	281				
Schnürdraht	163				

SILVER, Septummeißel.....	233	Stanze, KERRISON.....	109, 182	Tele-Laryngoskop	17
Sinoskopietrokar.....	215	Stanze, KOFLER-HAJEK	182	THILENIUS, Tonsillenzange	283
SINUS, Nasensonde	261	Stanze, OSTROEM	184	THUDICHUM, Nasenspekula.....	140
SINUS, Septumlevatorium.....	223	Stanze, SMITH-KERRISON	181	TIECK-HALLE, Nasenspekula.....	144
Sinusdilator, HALLE-RITTER	261	Stanze, Zirkular	186	TILLEY, Tamponzange	74, 155
Sinuskop.....	15	STERNBERG, Wangenhalter	270	TITAN Mikro Nadelhalter	123
Sinuskopiezange	178, 179	STEVENS, feine Schere.....	196	TITAN Mikro Scheren	203-205
SLUDER-BALLENGER,		STEVENS, Supercutscchere.....	196	TOBOLD, Zungendrucker.....	270
Tonsillotom.....	305	Stichkoagulationselektrode,		Tonsillendissektor,	
SMITH-KERRISON, Stanze	181	bipolar.....	44	ALDERDYCE.....	290
Sonde, BOWMAN.....	262, 293	Stimmgabel, HARTMANN	58	Tonsillendissektor,	
Sonde, FRONTAL.....	261	Stimmgabel, LUCAE	59	CARPENTER	291
Sonde, KOCHER.....	317	Stimmgabel, REDA.....	58	Tonsillendissektor, HENKE	290
Sonde, RITTER-HALLE.....	261	Stimmgabel, RYDEL-SEIFFERT	59	Tonsillendissektor, HURD	290
Sonde, SINUS	261	Stimmgabel, SEIFFERT-RYDEL	59	Tonsillendissektor,	
Sonde, STACHE	63	Stimmgabeln.....	58, 59	LOPEZ-REINKE	290
Sonde, WILDER	261	Stirnlampe	26, 27	Tonsillendraht	302, 319
Spannarm, YASARGIL	57	Stirnlampe, CLAR.....	26	Tonsillenelevatorium, HENKE.....	290
Spannplatte, Dermatome.....	220	Stirnlampe, LED	27	Tonsillenelevatorium,	
Spatel, BRUENINGS	268	Stirnleuchte.....	24-27	YANKAUER	290
Spatel, BUCHWALD	268	Stirnspiegel, ZIEGLER	23	Tonsillenenukleator,	
Spatel, DOUGHTY	279	Stirnreifen f. ZIEGLER.....	23	CARPENTER	291
Spatel, FRENZEL	268	Stopfer, LUNIATSCHEK	292	Tonsillenklemme,	
Spatel, KROENIG.....	268	Storz-Aesculap-		BOETTCHER (SCHNIDT).....	281
Spatel, Laryngoskop.....	323-331	Kaltlichtkabeladapter	20	Tonsillenklemme, MIKULICZ	283
Spatel, McIVOR.....	277	Stößel.....	98	Tonsillenklemme, NEGUS	281
Spatel, RING	272	STRABISMUS,		Tonsillenklemme, SAWTELL	281
Spatel, RUSSEL-DAVIS	278	feine Schere	116, 196	Tonsillenklemme, SCHNIDT	281
Speichelgangschere,		STRUEMPPEL,		Tonsillenklemme, SCHNIDT	
PERWITZSCHKY	298	Fremdkörperzangchen	75	(BOETTCHER).....	281
SPENCER, Fadenschere	199	STRUYCKEN,		Tonsillennadel.....	210, 306, 344
Spiegel, CLAR.....	26	scharfe Nasenzange.....	169	Tonsillennadel, CLAUS.....	285
Spiegel, MICHEL.....	345	Stützstange, Laryngoskop	335	Tonsillennadel, DUPUY-WEISS.....	285
Spiegel, ZIEGLER.....	23	Submukosamesser,		Tonsillennadel, NAGER	286
SPRATT, scharfer Löffel	103	FREER-INGALS	219	Tonsillenschere, BOETTCHER.....	296
Spritze, Tonsille	210, 306, 344	Supercutscchere,		Tonsillenschere, DEAN.....	296
Spülkanüle, EICKEN (KILLIAN).....	212	BABY-METZENBAUM.....	188	Tonsillenschere, GOOD.....	296
Spülkanüle, KILLIAN	212	Supercutscchere, STEVENS.....	196	Tonsillenschere, PRINCE	296
Spülkanüle, KILLIAN-EICKEN.....	212	Supercutscchere, WAGNER	197	Tonsillenschere, BRUENINGS	301
St. CLAIR-THOMSON,				Tonsillenschneider, EVES	301
Nasenrachenzange	310	T		Tonsillenschneider, ROEDER	303
St. CLAIR-THOMSON,		TABB, Messer.....	122	Tonsillenschneider, TYDING	300
Ringmesser	309	TAKAHASHI,		Tonsillenspritze	210, 306, 344
STACHE, Ohrsonde.....	63	scharfe Nasenzange.....	165	Tonsillenzange, ABRAHAM	282
STANDARD, Pinzette, chirurgisch.....	95	Tamponpinzette, JANSEN	150	Tonsillenzange, BALLENGER.....	281
STANDARD, Schere, chirurgisch	117	Tamponpinzette, TROELTSCH.....	149	Tonsillenzange, BLOHMKE	281
Stanze, Antrum.....	184, 185	Tamponstopfer, LUNIATSCHEK	292	Tonsillenzange, COLVER	281
Stanze, CITELLI	109	Tamponzange, LISTER (Sinus).....	155	Tonsillenzange, DENIS-BROWN	283
Stanze, DIETER	84	Tamponzange, LUBET-BARBON	154		
Stanze,		Tamponzange, TILLEY	74, 155		
FERRIS-SMITH-KERRISON	181	Tamponzange, WESTMACOTT	154		
Stanze, HAJEK-KOFLER.....	182, 183				

Tonsillenzange, HARTMANN307	V	WILDE, Polypenschnürer72, 163
Tonsillenzange, MARSCHIK282	Ventilball, KABIERSKE60	WILDER, Nasensonde261
Tonsillenzange, THILENIUS283	Verbindungskabel, bipolar39	WILLIGER, Raspatorium87
Tonsillenzange, TYDING282	Verlängerungsrohr,	WILLIGER, scharfer Löffel105
Tonsillenzange, WHITE281	BRUENINGS354	WILLIGER, Wundhaken114
Tonsillotom,	VIENNA, Nasenspekula143	Winter+IBE, Adapter20
BALLENGER-SLUDER305	VOLKMANN, scharfer Löffel104	Wolf-Kaltlichtkabeladapter20
TOYNBEE, Ohrspekula53	Volpi-Schölly-RFO, Adapter20	WULLSTEIN,
Trachealdilatator,	VOLTOLINI, Nasenspekula140	Mikro Löffelzängchen79
TROUSSEAU-BABY314	Vomerzange,	WULLSTEIN,
Trachealhaken, BOSE315	CRAIG-DOMINICK158	Mikro Ohrscheren83
Trachealhaken, JACKSON314	VOSS-KRAUSE,	WULLSTEIN,
Trachealhaken, NEWS315	Polypenschnürer162	Mikro Ohrzängchen79
Trachealkanüle,	W	WULLSTEIN, Raspatorium92
CHEVALIER-JACKSON316	WAGENER, Wundhäkchen66	WULLSTEIN, Sauggriff127, 129
Trachealkanüle, LUER316	WAGENER-MOSHER,	WULLSTEIN, Saugrohr127
Trachealkanüle,	Trachealkanüle315	WULLSTEIN, Sichelmesser122
WAGENER-MOSHER315	WAGNER, feine Schere197	WULLSTEIN, Wundspreizer113
Trachealwundspreizer, BOSE314	WAGNER, Supercuttschere197	Wundhäkchen, BARSKY248
Tracheldilatator, LABORDE314	WALSHAM, Septumrichtzange160	Wundhäkchen, BERGMANN250
Tracheldilatator, TROUSSEAU314	WALTER, Flachmeißel235	Wundhäkchen, FRAZIER246
Trachelhaken, ITERSON315	Wangenhalter270	Wundhäkchen, FREER254
Transformator26	Wangenhalter,	Wundhäkchen, GILLIES254
TROELTSCH,	CAWOOD-MINNESOTA268	Wundhäkchen, GRAEFE246
Nasentamponpinzette149	Wangenhalter, STERNBERG270	Wundhäkchen, GUTHRIE246
TROELTSCH-WILDE,	Warmlichtgriff333	Wundhäkchen, HUMBY248
Ohr-Nasen-Pinzette94, 152	WATSON, Dermatom221	Wundhäkchen, JOSEPH247
Trokar, COAKLEY215	WATSON-WILLIAMS,	Wundhäkchen,
Trokar, LICHTWITZ215	scharfe Nasenzange166	KLEINERT-KUTZ247
Trokar, Sinoskopie215	Watteträger63, 64, 347	Wundhäkchen, KNAPP250
Trommelfellnadel, LUCAE70	Watteträger, FARRELL63	Wundhäkchen, LAHEY246
Trommelfellnadel, POLITZER70, 71	Watteträger, FEIN347	Wundhäkchen, LUCAE66, 250
TROUSSEAU, Trachealdilatator...314	Watteträger, FROHN63	Wundhäkchen, REDA249
TROUSSEAU-BABY,	Watteträger, JOBSON-HORNE64	Wundhäkchen, ROLLET250
Trachealdilatator314	Watteträger, KILLIAN347	Wundhäkchen, TYRELL246
Tumorschere207	Watteträger, REDA64	Wundhaken,
Tupferzange, DUPLAY295	Watteträger, UCKERMANN64	BRÜNINGS-BRUNK263
TYDING, Tonsillenschnürer300	WEBER-LOCH, Ohrschlinge67	Wundhaken, HOFER289
TYDING, Tonsillenzange282	WEBSTER, Nadelhalter209	Wundhaken,
TYRELL, Wundhäkchen246	WEIL-BLAKESLEY,	KOCHER-LANGENBECK263
U	Nasenzange164, 168	Wundhaken, LOTHROP288
UCKERMANN, Watteträger64	WEITLANER, Wundspreizer111	Wundhaken, LOVE288
Uhrmacherpinzetten96	WEST, Septummeißel236	Wundhaken, MASING251
Umstechungsnadel,	WESTMACOTT,	Wundhaken, MIDDELDORPF263
Laryngoskopie353	Nasentamponzange154	Wundhaken, NAGER289
UNIVERSAL,	WHITE, Tonsillenzange281	Wundhaken, ROUX-BABY263
Draht- u. Blechscherer118, 299	WIEDER, Zungendrücker269	Wundhaken, WILLIGER114
UNIVERSAL, Pulverbläser60	WIEN, Nasenspekula143	Wundsperrer110-113
Uvulahaken, LOTHROP288	WIENER, Antrumraspel238	Wundsperrer, ADSON112
Uvulahaken, LOVE288	WILDE (TROELTSCH),	Wundsperrer, ALM110
	Ohr-Nasen-Pinzette94, 152	Wundsperrer, BOSE314
		Wundsperrer, FINSEN110

Wundsperrerr, FISCH	112, 265	Zange, CRAIG-DOMINICK	158	Zungenspatel, DAVIS-BOYLE	273
Wundsperrerr, HOLZHEIMER	110	Zange, DENIS-BROWN	283	Zungenspatel, DOUGHTY	279
Wundsperrerr, JANSEN	110	Zange, FRAENKEL	342	Zungenspatel, FRENZEL	268
Wundsperrerr, MOLLISON	112	Zange, HARTMANN	154, 169, 307	Zungenspatel, Holz	268
Wundsperrerr, PLESTER	113, 264	Zange, HEYMANN	157	Zungenspatel, KROENIG	268
Wundsperrerr, WEITLANER	111	Zange, HOUSE-GELFOAM	85	Zungenspatel, McIVOR	277
Wundsperrerr, WULLSTEIN	113	Zange, JACKSON-CHEVALIER	356	Zungenspatel, RING	272
X		Zange, JANSEN-MIDDLETON	159	Zungenspatel, RUSSEI-DAVIS	278
Xenon-Stirnlampe	27	Zange, JATHO	310	Zungenzange, COLLIN	270
Y		Zange, JURASZ	311, 342	Zungenzange, YOUNG	270
YANKAUER, Saugrohr	284	Zange, KEYMANN-KNIGHT	156	Zystoskop	16
YANKAUER,		Zange, KNIGHT	157		
Tonsillenelevatorium	290	Zange, LAHEY	318		
YASARGIL,		Zange, LITTAUER	156		
Fixiervorrichtung	57, 148	Zange, LUBET-BARBON	154		
YASARGIL, flexibler Spannarm	57	Zange, LUC	157		
YASARGIL, Ohrspekulahalter	57	Zange, MARSCHIK	282		
YASARGIL, Ohrtrichterhalter	57	Zange, McINDOE	108, 208		
YOUNG, Zungenzange	270	Zange, MIDDLETON-JANSEN	159		
Z		Zange, NOYES	155		
Zängchen, BUCK	73	Zange, Ohr	131		
Zängchen, DUCKBILL	75	Zange, RUBIN	161		
Zängchen, GREVEN	81	Zange, Sinuskopie	178, 179		
Zängchen, HARTMANN	74, 75	Zange, St. CLAIR-THOMSON	310		
Zängchen,		Zange, STRUYCKEN	169		
HARTMANN-HOFFMANN	75, 175	Zange, THILENIUS	283		
Zängchen,		Zange, TYDING	282		
HARTMANN-WEINGÄRTNER	75	Zange, WALSHAM	160		
Zängchen,		Zange, WATSON-WILLIAMS	166		
HARTMANN-WULLSTEIN	75, 175	Zange, WEIL-BLAKESLEY	164, 168		
Zängchen, LITTAUER	74	Zange, WESTMACOTT	154		
Zängchen, McGEE	81	Zange, WHITE	281		
Zängchen, Mikro	75-81	Zange, YOUNG	270		
Zängchen, Ohr	76, 77	ZAUFAL, Ohrhebel	65		
Zängchen, SCHUHKNECHT	81	ZAUFAL-JANSEN,			
Zängchen, STRUEMPEL	75	Hohlmeißelzange	107		
Zängchen, TILLEY	74, 155	ZAUFAL-JANSEN, Ohrhebel	65		
Zängchen, WULLSTEIN	79	ZIEGLER, Stirnspiegel	23		
Zange, ABRAHAM	282	Zirkularstanze	186		
Zange, ASCH	160	ZÖLLNER, Saugrohr	125		
Zange, BALLENGER	281	Zugendrücker, ANDREW	269		
Zange, Biopsie	15, 167	Zugendrücker, DINGMANN	276		
Zange, BLAKESLEY	164, 168, 180	Zugendrücker, HARTMANN	269		
Zange, BLOHMKE	281	Zugendrücker,			
Zange, BRUENINGS	158	KILNER-DOUGHTY	275		
Zange, CHEVALIER-JACKSON	356	Zugendrücker,			
Zange, COLLIN	270	MORITZ-SCHMIDT	269		
Zange, COLVER	281	Zugendrücker, TOBOLD	270		
Zange, CRAIG	158	Zugendrücker, WIEDER	269		
		Zungenspatel	268		
		Zungenspatel, BRUENINGS	268		
		Zungenspatel, BUCHWALD	268		

A

ABRAHAM forceps.....	282
ABRAHAM knife.....	287
adaptor for cable.....	20
adenoid BARNHILL.....	308
adenoid curette BECKMANN.....	308
adenoid curette	
St. CLAIR-THOMSON.....	309
adenotome LAFORCE.....	309
ADSON dressing forceps.....	97
ADSON tissue forceps.....	97
ADSON retractor.....	111
air bag POLITZER.....	61
alar retractor CONVERSE.....	252
alar retractor COTTLE.....	252, 253
alar retractor	
COTTLE-NEIVERT.....	252
alar retractor FOMON.....	253
alar retractor KILNER.....	253
ALDERDYCE tonsil dissector.....	290
ALM retractor.....	109
ANDREW tongue depressor.....	269
antrum curette COAKLEY.....	256
antrum curette FAULKNER.....	256
antrum elevator SEWALL.....	226
antrum punch.....	184, 185
antrum curette.....	256, 257
applicator cotton FARRELL.....	63
applicator cotton FROHN.....	63
applicator cotton	
JOBSON-HORNE.....	64
applicator cotton REDA.....	64
applicator cotton UCKERMANN.....	64
ASCH septum straightening forceps.....	160
AUFRICHT nasal rasp.....	239
AUFRICHT nasal retractor.....	251

B

BALLENGER septum elevator.....	225
BALLENGER tonsil forceps.....	281
BALLENGER	
septum swivel knife.....	218
BANE-HARTMANN	
bone rongeur.....	106
BARACANI tip.....	354
BARANY noise apparatus.....	60
BARBARA needle ROSEN... 135, 136	
BARNHILL adenoid curette.....	308
BARON suction tube.....	128
BARRAQUER	
micro needle holder.....	123

BARSKY retractor.....	248
BARTH bone curette.....	104
BECKMANN adenoid curette.....	308
BELLUCCI micro ear scissors.....	80
bending device SCHUKNECHT... 85	
BERGMANN retractor.....	250
BEUSE face lift scissors.....	201
BEYER bone rongeur.....	107
BILLEAU ear loop.....	65
biopsy forceps.....	15
biopsy punch.....	179
bipolar suction forceps.....	42
bipolar forceps.....	36, 37, 38
bipolar cable.....	39
bipolar stitch electrode.....	44, 45
bipolar forceps NON STICK... 40, 41	
blades tongue DOUGHTY.....	279
blades tongue RUSSEL-DAVIS... 278	
blepharoplasty scissors	
GREENBERG-PAR.....	202
blepharoplasty scissors KAYE.....	202
BLOHMKE tonsil forceps.....	281
BLUMENTHAL bone rongeur.....	106
BOETTCHEER tonsil scissors.....	296
BÖHLER bone rongeur.....	107, 108
BOIES nasal fracture elevator.....	226
bone rongeur	
BANE-HARTMANN.....	106
bone curette BARTH.....	104
bone rongeur BEYER.....	107
bone rongeur BLUMENTHAL.....	106
bone rongeur BÖHLER.....	107, 108
bone punch CITELLI.....	109
bone rongeur	
COTTLE-KAZANJIAN.....	108
bone curette DAUBENSPECK... 258	
bone punch	
FERRIS-SMITH-KERRISON.....	181
bone curette HALLE.....	104, 258
bone rongeur KLEINERT-KUTZ... 107	
bone curette LEMPERS.....	103
bone rongeur LEMPERS.....	107
bone rongeur LUER.....	106
bone curette MARTINI.....	105
bone rongeur MC INDOE.....	108
bone tamper PASSOW.....	98, 235
bone curette SPRATT.....	103
bone curette VOLKMANN.....	104
bone curette WILLIGER.....	105
bone rongeur ZAUFAL-JANSEN... 107	
bone curette JANSEN.....	103
bone cutting forceps	

COTTLE-KAZANJIAN.....	208
bone cutting forceps MC INDOE... 208	
BONN scissors.....	192
BOSE tracheal spreader.....	314, 315
BOUCHERON ear specula.....	53
BOWMAN lachrymal probe.....	262
BOWMAN salivary duct probe.....	293
bronchoscope forceps	
CHEVALIER-JACKSON.....	356
bronchoscope.....	18
BRUENINGS tongue depressor... 268	
BRUENINGS	
nasal septum forceps.....	158
BRUENINGS tonsil knife.....	287
BRUENINGS tonsil snare.....	301
BRUENINGS ear specula set.....	55
BRUENINGS handle.....	354
BRUENINGS tip.....	354
BRÜNING-SBRUNK retractor... 263	
BRÜNING-SLUCAS gouge.....	98
BUCHWALD tongue depressor... 268	
BUCK ear curette.....	68, 69
BUCK foreign body lever.....	73
burr.....	30, 31

C

cable bipolar.....	39
cable light guide.....	19
CANFIELD tonsil knife.....	287
cannula EICKEN.....	212
cannula KILLIAN.....	212
cannula laryngeal.....	210, 306, 344
cannula septum.....	210, 306, 344
cannula tracheal	
CHEVALIER-JACKSON.....	316
cannula tracheal LUER.....	316
CAPLAN nasal scissors.....	206
CARPENTER tonsil enucleator... 291	
carrier cotton FEIN.....	347
carrier cotton KILLIAN.....	347
carrier cotton.....	347
carrier fibreglass light.....	337, 338
cartilage crusher COTTLE.....	237
cartilage file DINGMANN.....	130
cartilage knife MASING.....	219
CASTROVIEJO	
micro needle holder.....	124
catheter ear HARTMANN.....	70
CAWOOD-MINNESOTA	
tongue depressor.....	268
cheek retractor STERNBERG... 270	
cheek retractor.....	270

chest support LEWY.....	336	COTTLE-JOSEPH		DENIS BROWNE tonsil forceps ...	283
chest support NEGUS.....	280	septum elevator.....	224	depressor tongue ANDREW.....	269
CHEVALIER-JACKSON		COTTLE-KAZANJIAN		depressor tongue BRUENINGS ...	268
tracheal cannula.....	316	bone cutting forceps.....	208	depressor tongue BUCHWALD ...	268
CHEVALIER-JACKSON		COTTLE-KAZANJIAN		depressor tongue	
bronchoscope forceps.....	356	bone rongeur.....	108	CAWOOD-MINNESOTA.....	268
chisel FREER.....	100	COTTLE-MASING		depressor tongue	
chisel PARTSCH.....	99	nasal scissors.....	198	DAVIS-BOYLE.....	273
chisel WALTER.....	235	COTTLE-NEIVERT		depressor tongue FRENZEL.....	268
chisel.....	98	alar retractor.....	252	depressor tongue HARTMANN ...	269
chisel rhinoplasty CINELLI.....	232	cotton applicator FARRELL.....	63	depressor tongue KROENIG.....	268
chisel rhinoplasty COTTLE.....	231	cotton carrier FEIN.....	347	depressor tongue	
chisel rhinoplasty FOMON.....	232	cotton applicator FROHN.....	63	MORITZ-SCHMIDT.....	269
chisel rhinoplasty		cotton applicator		depressor tongue RING.....	272
NEIVERT-ANDERSON.....	233	JOBSON-HORNE.....	64	depressor tongue TOBOLD.....	270
chisel rhinoplasty SHEEHAN.....	232	cotton carrier KILLIAN.....	347	depressor tongue WIEDER.....	269
chisel rhinoplasty SILVER.....	233	cotton applicator REDA.....	64	depressor tongue.....	268
chisel septum FREER.....	230	cotton applicator UCKERMANN.....	64	DERF needle holder.....	209
choana hook LANGE.....	255	cotton carrier.....	347	DERLACKI tissue forceps.....	97
CINELLI rhinoplasty chisel.....	232	CRAIG nasal septum forceps.....	158	dermatome HUMBY.....	221
circular punch.....	186	CRAIG-DOMNICK		dermatome SCHINK.....	220
CITELLI bone punch.....	109	nasal septum forceps.....	158	dermatome SILVER.....	221
clamp muscular MASTIN.....	318	CRILE-WOOD needle holder.....	209	dermatome WATSON.....	221
CLAUS tonsil needle.....	285	crusher cartilage COTTLE.....	237	diagnostic set.....	48, 49, 50, 51, 52
coagulation suction tube.....	211	curette adenoid BARNHILL.....	308	DIETER malleus punch.....	84
coagulator monopolar suction.....	43	curette adenoid BECKMANN.....	308	dilator lachrymal WILDER.....	261
COAKLEY antrum curette.....	256	curette adenoid		dilator sinus RITTER-HALLE.....	261
COAKLEY trocar.....	215	St. CLAIR-THOMSON.....	309	dilator tracheal LABORDE.....	314
COLLIN tongue forceps.....	270	curette antrum COAKLEY.....	256	dilator tracheal TROUSSEAU.....	314
columella forceps COTTLE.....	153	curette antrum FAULKNER.....	256	dilator tracheal	
COLVER tonsil forceps.....	281	curette antrum.....	256, 257	TROUSSEAU-BABY.....	314
CONVERSE nasal knife.....	217	curette bone BARTH.....	104	DINGMANN cartilage file.....	130
CONVERSE alar retractor.....	252	curette bone DAUBENSPECK.....	258	DINGMANN mouth gag.....	276
CONVERSE scissors.....	194	curette bone HALLE.....	104, 258	DINGMANN nasal rasp.....	244
CORDES tip.....	354	curette bone LEMPERS.....	103	dissecting scissors GORNEY.....	116
COTTLE rhinoplasty chisel.....	231	curette bone MARTINI.....	105	dissecting scissors JAMESON.....	191
COTTLE cartilage crusher.....	237	curette bone SPRATT.....	103	dissecting scissors	
COTTLE septum elevator.....	224, 225	curette bone VOLKMANN.....	104	JOSEPH.....	116, 190
COTTLE columella forceps.....	153	curette bone WILLIGER.....	105	dissecting scissors KELLY.....	191
COTTLE ear forceps.....	94	curette bone JANSEN.....	103	dissecting scissors KILNER.....	191
COTTLE nasal forceps.....	152	curette ear BUCK.....	68, 69	dissecting scissors	
COTTLE nasal knife.....	217	curette micro HOUSE.....	133	METZENBAUM.....	115, 188, 189, 297
COTTLE nasal rasp.....	239			dissecting scissors	
COTTLE alar retractor.....	252, 253	D		METZENBAUM FINO.....	115, 189
COTTLE finger ring retractor.....	255	DAUBENSPECK bone curette.....	258	dissecting scissors RAGNELL.....	191
COTTLE nasal retractor.....	251	DAVIS-BOYLE		dissecting scissors REYNOLDS... 191	
COTTLE nasal scissors.....	198	tongue depressor.....	273	dissecting scissors	
COTTLE nasal specula.....	146, 147	DAVIS-BOYLE mouth gag.....	274	SANVENERO.....	190
COTTLE mallet.....	102, 260	DAVIS-MEYER mouth gag.....	277	dissecting scissors	
COTTLE osteotome.....	100	DAY ear hook.....	66	STRABISMUS.....	116, 196
COTTLE retractor.....	254	DEAN tonsil scissors.....	296	dissector FISCH.....	93
COTTLE scissors.....	194	DENHART mouth gag.....	271	dissector thyroid KOCHER.....	317

dissector tonsil ALDERDYCE290
 dissector tonsil HURD290
 dissector tonsil LOPEZ-REINKE ..290
 DOUGHTY tongue blades279
 DOYEN-JANSEN mouth gag271
 dressing forceps ADSON.....97
 dressing forceps DUPLAY295
 dressing forceps GRAEFE95
 dressing forceps POTTS-SMITH..294
 dressing forceps SEMKEN95
 dressing forceps STANDARD.....95
 dressing forceps295
 DUCKBILL micro ear forceps75
 DUPLAY dressing forceps295
 DUPUY-WEISS tonsil needle285

E

ear specula BOUCHERON.....53
 ear curette BUCK68, 69
 ear forceps COTTLE94
 ear hook DAY66
 ear specula GRUBER.....53
 ear specula HARTMANN.....53
 ear catheter HARTMANN.....70
 ear forceps HARTMANN74
 ear forceps LITTAUER74
 ear hook LUCAE.....66
 ear forceps LUCAE.....94
 ear syringe REINER61
 ear loop SHAPLEIGH.....67
 ear probe STACKE63
 ear hook WAGENER66
 ear forceps WILDE
 (TROELTSCH).....94
 ear loop ZAUFAL.....65
 ear elevator ZAUFAL-JANSEN.....65
 ear specula55, 56
 ear syringe62
 ear loop BILLEAU.....65
 ear specula FARRIOR.....54
 ear spoon GROSS.....65
 ear loop LANGENBECK65
 ear specula POLITZER53
 ear forceps TILLEY.....74
 ear specula TOYNBEE.....53
 ear loop WEBER-LOCH67
 ear hook65, 66
 ear polypus forceps
 HARTMANN175
 ear polypus forceps
 HARTMANN-HOFFMANN.....175
 ear polypus forceps

HARTMANN-WULLSTEIN175
 ear polypus snare KRAUSE72
 ear polypus snare WILDE.....72
 ear specula holder YASARGIL57
 ear specula set BRUENINGS55
 ear specula set SIEGLE56
 EICKEN cannula212
 electrode bipolar stitch.....44, 45
 electrodes34, 35
 elevator FREER.....91
 elevator LEMPERS88, 91
 elevator McKENTY.....92
 elevator QUERVAIN86
 elevator SEBILEAU86
 elevator138
 elevator antrum SEWALL226
 elevator ear ZAUFAL-JANSEN.....65
 elevator nasal FRONTAL.....261
 elevator nasal SINUS261
 elevator nasal fracture BOIES226
 elevator septum BALLENGER225
 elevator septum COTTLE.....224, 225
 elevator septum
 COTTLE-JOSEPH.....224
 elevator septum FREER.....223
 elevator septum
 HAJEK-BALLENGER225
 elevator septum HALLE.....222
 elevator septum HOWARTH.....224
 elevator septum JOSEPH.....222
 elevator septum KILLIAN.....223, 225
 elevator septum MASING222
 elevator septum McKENTY ..222, 224
 elevator septum PENNINGTON ..224
 elevator septum PIERCE.....223
 elevator septum ROGER.....222
 elevator septum SINUS223
 elevator septum fracture
 GOLDMANN.....226
 elevator tonsil HENKE290
 elevator tonsil YANKAUER.....290
 elevator laryngeal suction352
 endoscope18
 enucleator tonsil CARPENTER291
 epiglottis retractor REICHERT.....343
 ethmoid forceps TAKAHASHI.....165
 ethmoid forceps
 WATSON-WILLIAMS.....166
 ethmoid forceps
 WEIL-BLAKESLEY164
 EVES tonsil snare.....301

F

face lift scissors BEUSE.....201
 face lift scissors GORNEY.....200
 face lift scissors
 GORNEY-FREEMAN200
 face lift scissors KAYE.....201
 face lift scissors
 PECK-JOSEPH201
 FARABEUF raspatory90
 FARRELL cotton applicator63
 FARRIOR ear specula54
 FAULKNER antrum curette256
 FEIN cotton carrier347
 FERGUSSON suction tube213
 FERRIS-SMITH-KERRISON
 bone punch.....181
 fibreglass light carrier337, 338
 fibreglass laryngoscope339
 file cartilage DINGMANN.....130
 finger ring retractor COTTLE255
 FINSEN retractor109
 FISCH micro ear scissors.....82
 FISCH dissector93
 FISCH retractor111, 265
 FISHER tonsil knife286
 FOMON rhinoplasty chisel.....232
 FOMON nasal rasp.....240, 241
 FOMON alar retractor.....253
 FOMON nasal scissors.....198
 forceps biopsy15
 forceps bipolar36, 37, 38
 forceps bipolar NON STICK40, 41
 forceps bone cutting
 COTTLE-KAZANJIAN208
 forceps bone cutting MC INDOE ..208
 forceps bronchoscope
 CHEVALIER-JACKSON356
 forceps columella COTTLE153
 forceps dressing ADSON.....97
 forceps dressing DUPLAY295
 forceps dressing GRAEFE95
 forceps dressing POTTS-SMITH ..294
 forceps dressing SEMKEN.....95
 forceps dressing STANDARD.....95
 forceps dressing295
 forceps ear COTTLE94
 forceps ear HARTMANN74
 forceps ear LITTAUER74
 forceps ear LUCAE.....94
 forceps ear WILDE
 (TROELTSCH).....94
 forceps ear TILLEY.....74

forceps ear polypus HARTMANN	175	(Sinus).....	155	forceps tonsil WHITE.....	281
forceps ear polypus HARTMANN-HOFFMANN.....	175	forceps nasal dressing LUBET-BARBON.....	154	forceps tonsil abscess THILENIUS.....	283
forceps ear polypus HARTMANN-WULLSTEIN	175	forceps nasal dressing NOYES.....	155	forceps micro laryngeal	350, 351
forceps ethmoid TAKAHASHI.....	165	forceps nasal dressing TILLEY.....	155	forceps bipolar suction	42
forceps ethmoid WATSON-WILLIAMS.....	166	forceps nasal dressing WESTMACOTT	154	foreign body lever BUCK.....	73
forceps ethmoid WEIL-BLAKESLEY.....	164	forceps nasal polypus HEYMANN-KNIGHT.....	156	foreign body lever QUIRE.....	73
forceps jeweler	96	forceps nasal polypus LITTAUER	156	fork tuning HARTMANN	58
forceps laryngeal JACKSON	343	forceps nasal septum BRUENINGS	158	fork tuning LUCAE.....	59
forceps laryngeal polypus FRAENKEL.....	342	forceps nasal septum CRAIG.....	158	fork tuning RYDEL-SEIFFERT	59
forceps laryngeal polypus JURASZ.....	342	forceps nasal septum CRAIG-DOMNICK.....	158	fork tuning	58, 59
forceps maxillary sinus	176, 177	forceps nasal septum HEYMANN.....	157	FRAENKEL	
forceps micro ear DUCKBILL	75	forceps nasal septum KNIGHT.....	157	laryngeal polypus forceps.....	342
forceps micro ear HARTMANN	75	forceps nasal septum LUC.....	157	FRAENKEL tip	354
forceps micro ear HARTMANN-HOFFMANN.....	75	forceps nasal septum MIDDLETON-JANSEN	159	FRAZIER retractor	246
forceps micro ear HARTMANN-WEINGÄRTNER	75	forceps naso pharyngeal JATHO.....	310	FRAZIER/FERGUSSON	
forceps micro ear HARTMANN-WULLSTEIN	75	forceps naso pharyngeal JURASZ.....	311	suction tube	125, 213
forceps micro ear ...75, 76, 77, 78, 79		forceps naso pharyngeal St. CLAIR-THOMSON.....	310	FREER septum chisel	230
forceps morselizer RUBIN.....	161	forceps pressure HOUSE-GELFOAM.....	85	FREER septum elevator.....	223
forceps nasal COTTLE.....	152	forceps seizing LAHEY.....	318	FREER nasal knife	216
forceps nasal GILLIES.....	151	forceps septum straightening ASCH.....	160	FREER chisel	100
forceps nasal GRAEFE	151	forceps septum straightening WALSHAM	160	FREER elevator	91
forceps nasal JANSEN	150	forceps tissue ADSON.....	97	FREER gouge	236
forceps nasal JANSEN-GRUENWALD.....	150	forceps tissue DERLACKI	97	FREER retractor	254
forceps nasal LUCAE	152	forceps tissue POTTS-SMITH.....	294	FREER-INGALS mucosa knife.....	219
forceps nasal McINDOE.....	151	forceps tissue SEMKEN	95	FRENZEL nystagmus spectacle	22
forceps nasal TROELTSCH.....	149	forceps tongue YOUNG.....	270	FRENZEL tongue depressor	268
forceps nasal WILDE (TROELTSCH).....	152	forceps tongue COLLIN.....	270	FROHN cotton applicator	63
forceps nasal	167, 180	forceps tonsil ABRAHAM.....	282	FRONTAL nasal elevator.....	261
forceps nasal cutting HARTMANN	169	forceps tonsil BALLENGER.....	281		
forceps nasal cutting SCHMEDEN	169	forceps tonsil BLOHMKE.....	281	G	
forceps nasal cutting STRUYCKEN	169	forceps tonsil COLVER.....	281	gag mouth DAVIS-BOYLE.....	274
forceps nasal cutting WEIL-BLAKESLEY.....	168	forceps tonsil DENIS BROWNE	283	gag mouth DAVIS-MEYER.....	277
forceps nasal cutting	170-174, 178	forceps tonsil MARSCHIK	282	gag mouth DENHART	271
forceps nasal dressing HARTMANN	154	forceps tonsil MIKULICZ.....	283	gag mouth DINGMANN	276
forceps nasal dressing LISTER		forceps tonsil NEGUS.....	281	gag mouth DOYEN-JANSEN	271
		forceps tonsil SAWTELL.....	281	gag mouth HEISTER.....	271
		forceps tonsil SCHNIDT	281	gag mouth JENNINGS	271
		forceps tonsil TYDING.....	282	gag mouth KILNER-DOUGHTY	275
				gag mouth MAUNDER	280
				gag mouth McIVOR.....	277
				gag mouth MOLT.....	271
				gag mouth ROSER-KOENIG.....	271
				GALLAHER nasal rasp.....	243
				gauze packer LUNIATSCHEK	292
				GERZOG mallet	259
				GILLIES nasal forceps.....	151
				GILLIES retractor	254
				GLABELLA nasal rasp.....	238
				GOLDMANN	
				septum fracture elevator.....	226
				GOOD tonsil scissors	296

GORNEY dissecting scissors.....	116	HARTMANN ear specula.....	53	J	
GORNEY face lift scissors.....	200	HARTMANN nasal specula.....	142	JACKSON laryngeal forceps.....	343
GORNEY-FREEMAN		HARTMANN-HALLE		JACKSON tracheal hook.....	314
face lift scissors.....	200	nasal specula.....	141	JAMESON dissecting scissors.....	191
gouge BRÜNINGS-LUCAS.....	98	HARTMANN-HOFFMANN		JANSEN bone curette.....	103
gouge FREER.....	236	ear polypus forceps.....	175	JANSEN nasal forceps.....	150
gouge LEXER MINI.....	100	HARTMANN-HOFFMANN		JANSEN raspatory.....	91
gouge PARTSCH.....	99	micro ear forceps.....	75	JANSEN retractor.....	109
gouge WEST.....	236	HARTMANN-WEINGÄRTNER		JANSEN-GRUENWALD	
gouge.....	98	micro ear forceps.....	75	nasal forceps.....	150
gouge rhinoplasty HAJEK.....	236	HARTMANN-WULLSTEIN		JATHO naso pharyngeal forceps..	310
gouge rhinoplasty		ear polypus forceps.....	175	JENNINGS mouth gag.....	271
KILLIAN-CLAUS.....	236	HARTMANN-WULLSTEIN		jeweler forceps.....	96
GRADLE scissors.....	195	micro ear forceps.....	75	JOBSON-HORNE cotton	
GRAEFE dressing forceps.....	95	head mirror ZIEGLER.....	23	applicator.....	64
GRAEFE nasal forceps.....	151	head light.....	24, 25, 26, 27	JOSEPH septum elevator.....	222
GRAEFE retractor.....	246	HEISTER mouth gag.....	271	JOSEPH nasal knife.....	216, 217
GRAEFE scissors.....	194	HENKE tonsil elevator.....	290	JOSEPH nasal rasp.....	238, 239
GREENBERG-PAR		HEYMANN		JOSEPH nasal saw.....	244, 245
blepharoplasty scissors.....	202	nasal septum forceps.....	157	JOSEPH	
GREVEN micro ear scissors.....	81	HEYMANN nasal scissors.....	198	dissecting scissors.....	116, 190
GROSS ear spoon.....	65	HEYMANN-KNIGHT		JOSEPH raspatory.....	88
GRUBER ear specula.....	53	nasal polypus forceps.....	156	JOSEPH retractor.....	247
GUILEN raspatory suction.....	227	HOFER palate retractor.....	289	JURASZ	
GUTHRIE retractor.....	246	HOLZHEIMER retractor.....	109	laryngeal polypus forceps.....	342
		hook PLESTER.....	137	JURASZ	
H		hook choana LANGE.....	255	naso pharyngeal forceps.....	311
HAJEK rhinoplasty gouge.....	236	hook ear DAY.....	66		
HAJEK mallet.....	102	hook ear LUCAE.....	66	K	
HAJEK-BALLENGER		hook ear WAGENER.....	66	KABIERSKE powder blower.....	60
septum elevator.....	225	hook ear.....	65, 66	KAYE blepharoplasty scissors.....	202
HAJEK-KOFLER punch.....	182, 183	hook laryngeal.....	352, 353	KAYE face lift scissors.....	201
HALLE bone curette.....	104, 258	hook tracheal ITERSON.....	315	KELLY dissecting scissors.....	191
HALLE septum elevator.....	222	hook tracheal JACKSON.....	314	KERRISON punch.....	109, 182
HALSEY needle holder.....	209	hook tracheal NEWS.....	315	KILLIAN cotton carrier.....	347
handle BRUENINGS.....	354	hooklet McGEE.....	136	KILLIAN septum elevator.....	223, 225
handle HUBER.....	354	HOUSE micro curette.....	133	KILLIAN laryngeal scissors.....	343
handle laryngeal.....	346	HOUSE measuring rod.....	132	KILLIAN nasal specula.....	144, 145
handle laryngoscope.....	332, 333	HOUSE suction tube.....	126, 214	KILLIAN cannula.....	212
handle suction WULLSTEIN.....	129	HOUSE-GELFOAM		KILLIAN-CLAUS	
HARTMANN ear catheter.....	70	pressure forceps.....	85	rhinoplasty gouge.....	236
HARTMANN tongue depressor.....	269	HOWARTH septum elevator.....	224	KILNER alar retractor.....	253
HARTMANN ear forceps.....	74	HUBER handle.....	354	KILNER dissecting scissors.....	191
HARTMANN		HUMBY dermatome.....	221	KILNER-DOUGHTY mouth gag.....	275
ear polypus forceps.....	175	HUMBY retractor.....	248	KLEINERT-KUTZ bone rongeur.....	107
HARTMANN micro ear forceps.....	75	HURD tonsil dissector.....	290	KLEINERT-KUTZ retractor.....	247
HARTMANN				KNAPP retractor.....	250
nasal cutting forceps.....	169	I		KNAPP scissors.....	193
HARTMANN		injection needle.....	349	knife PLESTER.....	122
nasal dressing forceps.....	154	instrument handle laryngeal.....	353	knife ROSEN.....	120, 121
HARTMANN tuning fork.....	58	IRIS operating scissors.....	117, 192	knife SCHUKNECHT.....	122
HARTMANN tonsil punch.....	307	ITERSON tracheal hook.....	315	knife TABB.....	122

knife WULLSTEIN	122	laryngeal handle	346	LOTHROP uvula retractor	288
knife	121	laryngeal knife	352, 353	LOVE uvula retractor	288
knife cartilage MASING	219	laryngeal hook	352, 353	LUBET-BARBON	
knife laryngeal	352, 353	laryngeal needle	352	nasal dressing forceps.....	154
knife mucosa FREER-INGALS.....	219	laryngeal instrument handle	353	LUC nasal septum forceps	157
knife nasal CONVERSE	217	laryngeal micro forceps	350, 351	LUCAE ear forceps.....	94
knife nasal COTTLE	217	laryngeal polypus snare.....	319	LUCAE nasal forceps	152
knife nasal FREER	216	laryngeal needle holder	349	LUCAE tuning fork.....	59
knife nasal JOSEPH	216, 217	laryngeal polypus forceps		LUCAE ear hook.....	66
knife septum swivel		FRAENKEL.....	342	LUCAE tympanum knife	70
BALLENGER	218	laryngeal polypus forceps		LUCAE retractor	250
knife sickle REDA	217	JURASZ.....	342	LUER tracheal cannula.....	316
knife tonsil ABRAHAM	287	laryngoscope McCOY.....	324, 331	LUER bone rongeur.....	106
knife tonsil BRUENINGS	287	laryngoscope McINTOSH		LUNIATSCHEK gauze packer	292
knife tonsil CANFIELD.....	287	322, 323, 327, 328		
knife tonsil FISHER	286	laryngoscope MILLER		M	
knife tympanum LUCAE	70	325, 326, 329, 330	mallet COTTLE.....	102, 260
knife tympanum POLITZER.....	70, 71	laryngoscope	17	mallet GERZOG	259
knife tympanum SEXTON	71	laryngoscope handle	332, 333	mallet HAJEK	102
KNIGHT nasal septum forceps.....	157	laryngoscope spare bulb	332, 333	mallet MEAD.....	102, 259
knot tier NEGUS	304	laryngoscope fibreglass	339	mallet PARTSCH	102, 260
knot laryngeal tier	352	laryngoscope operation		mallet QUISLING.....	260
KOCHER thyroid dissector.....	317	334, 335, 340, 341	mallet	102, 259
KOCHER-LANGENBECK		LEMPERT bone curette.....	103	mallet plastic	260
retractor	263	LEMPERT bone rongeur	107	malleus punch DIETER	84
KÖNIG raspatory	86	LEMPERT elevator	88, 91	MALTZ nasal rasp	238, 239
KRAUSE ear polypus snare	72	LEMPERT raspatory	88	MARSCHIK tonsil forceps	282
KRAUSE nasal polypus snare.....	162	lever foreign body BUCK.....	73	MARTINI bone curette.....	105
KRAUSE tip	354	lever foreign body QUIRE.....	73	MASING septum elevator.....	222
KRAUSE-VOSS		LEWIS nasal rasp.....	239	MASING cartilage knife	219
nasal polypus snare.....	162	LEWY chest support	336	MASING nasal rasp.....	242
KROENIG tongue depressor	268	LEXER osteotome	228	MASING nasal retractor	251
		LEXER MINI gouge	100	MASING-NEIVERT	
L		LEXER MINI osteotome	100	nasal retractor.....	251
LABORDE tracheal dilator.....	314	LEYLA retractor	148	MASTIN muscular clamp.....	318
lachrymal probe BOWMAN	262	LICHTWITZ trocar	215	MAUNDER mouth gag	280
lachrymal dilator WILDER	261	light fibreglass carrier	337, 338	maxillary sinus forceps	176, 177
LAFORCE adenotome	309	light guide cable	19	MC INDOE	
LAHEY seizing forceps.....	318	LINDEMANN nasal saw	245	bone cutting forceps	208
LAHEY retractor	246	LISTER (Sinus)		MC INDOE bone rongeur	108
LANGE choana hook.....	255	nasal dressing forceps.....	155	McCOY laryngoscope	324, 331
LANGE tip	354	LITTAUER ear forceps	74	McGEE hooklet	136
LANGENBECK ear loop.....	65	LITTAUER		McGHEE micro ear scissors.....	81
LANGENBECK raspatory	86	nasal polypus forceps.....	156	McINDOE nasal forceps.....	151
larangeal micro scissors	351	LITTAUER stitch scissors	199	McINTOSH laryngoscope	
laryngeal suction elevator.....	352	LITTLER scissors	194	322, 323, 327, 328
laryngeal forceps JACKSON	343	loop ear SHAPLEIGH.....	67	McIVOR mouth gag.....	277
laryngeal scissors KILLIAN.....	343	loop ear ZAUFAL.....	65	McKENTY septum elevator	222, 224
laryngeal mirror MICHEL	345	loop ear BILLEAU.....	65	McKENTY elevator	92
laryngeal knot tier	352	loop ear LANGENBECK.....	65	MEAD mallet	102, 259
laryngeal cannula	210, 306, 344	loop ear WEBER-LOCH.....	67	measuring rod HOUSE.....	132
laryngeal mirror	346	LOPEZ-REINKE tonsil dissector	290		

METZENBAUM dissecting scissors 115, 188, 189, 297	mouth gag DINGMANN276	nasal retractor MASING251
METZENBAUM FINO dissecting scissors..... 115, 189	mouth gag DOYEN-JANSEN271	nasal retractor MASING-NEIVERT.....251
MICHEL laryngeal mirror345	mouth gag HEISTER271	nasal forceps McINDOE 151
micro needle holder	mouth gag JENNINGS271	nasal rasp PARKES.....238
BARRAQUER.....123	mouth gag KILNER-DOUGHTY ..275	nasal rasp PEET.....238
micro needle holder	mouth gag MAUNDER280	nasal specula REDA.....144
CASTROVIEJO124	mouth gag McIVOR277	nasal elevator SINUS261
micro laryngeal forceps350, 351	mouth gag MOLT271	nasal specula THUDICHUM.....140
micro curette HOUSE133	mouth gag ROSER-KOENIG.....271	nasal specula TIECK-HALLE144
micro larangeal scissors351	mucosa knife FREER-INGALS.....219	nasal forceps TROELTSCH.....149
micro scissors 119, 131, 203-205	muscular clamp MASTIN318	nasal specula VOLTOLINI140
micro ear scissors BELLUCCI.....80	N	nasal specula WIEN143
micro ear forceps DUCKBILL75	NAGER tonsil needle.....286	nasal rasp WIENER.....238
micro ear scissors FISCH.....82	NAGER palate retractor.....289	nasal forceps WILDE (TROELTSCH).....152
micro ear scissors GREVEN81	nasal rasp AUFRICHT239	nasal forceps167, 180
micro ear forceps HARTMANN75	nasal retractor AUFRICHT.....251	nasal scissors187
micro ear forceps	nasal scissors CAPLAN.....206	nasal cutting forceps
HARTMANN-HOFFMANN.....75	nasal knife CONVERSE217	HARTMANN169
micro ear forceps	nasal specula COTTLE146, 147	nasal cutting forceps
HARTMANN-WEINGÄRTNER75	nasal forceps COTTLE152	SCHMEDEN169
micro ear forceps	nasal scissors COTTLE.....198	nasal cutting forceps
HARTMANN-WULLSTEIN75	nasal knife COTTLE217	STRUYCKEN169
micro ear scissors McGHEE.....81	nasal rasp COTTLE.....239	nasal cutting forceps
micro ear scissors	nasal retractor COTTLE251	WEIL-BLAKESLEY.....168
SCHUKNECHT.....81	nasal scissors	nasal cutting forceps170-174, 178
micro ear scissors SHEA.....80	COTTLE-MASING198	nasal dressing forceps
micro ear scissors WULLSTEIN.....83	nasal rasp DINGMANN244	HARTMANN154
micro ear forceps ...75, 76, 77, 78, 79	nasal scissors FOMON.....198	nasal dressing forceps
MIDDELDORPF retractor263	nasal rasp FOMON.....240, 241	LISTER (Sinus).....155
MIDDLETON-JANSEN	nasal knife FREER216	nasal dressing forceps
nasal septum forceps159	nasal elevator FRONTAL.....261	LUBET-BARBON.....154
MIKULICZ tonsil forceps.....283	nasal rasp GALLAHER.....243	nasal dressing forceps NOYES....155
MILLER laryngoscope	nasal forceps GILLIES.....151	nasal dressing forceps TILLEY....155
.....325, 326, 329, 330	nasal rasp GLABELLA.....238	nasal dressing forceps
MILLER raspatory92	nasal forceps GRAEFE151	WESTMACOTT154
MINI-LAMBOTTE osteotome	nasal specula HARTMANN142	nasal fracture elevator BOIES.....226
.....99, 229	nasal specula	nasal polypus forceps
mirror head ZIEGLER.....23	HARTMANN-HALLE.....141	HEYMANN-KNIGHT.....156
mirror laryngeal MICHEL345	nasal scissors HEYMANN198	nasal polypus snare KRAUSE.....162
mirror laryngeal346	nasal forceps JANSEN150	nasal polypus snare
MOLLISON retractor111	nasal forceps	KRAUSE-VOSS.....162
MOLT mouth gag271	JANSEN-GRUENWALD150	nasal polypus forceps
MOLT raspatory92	nasal knife JOSEPH.....216, 217	LITTAUER156
monopolar suction coagulator43	nasal rasp JOSEPH.....238, 239	nasal polypus snare WILDE163
MORITZ-SCHMIDT	nasal saw JOSEPH244, 245	nasal septum forceps
tongue depressor.....269	nasal specula KILLIAN144, 145	BRUENINGS158
morselizer forceps RUBIN161	nasal rasp LEWIS.....239	nasal septum forceps CRAIG.....158
mouth gag DAVIS-BOYLE.....274	nasal saw LINDEMANN245	nasal septum forceps
mouth gag DAVIS-MEYER.....277	nasal forceps LUCAE152	CRAIG-DOMNICK.....158
mouth gag DENHART271	nasal rasp MALTZ238, 239	nasal septum forceps HEYMANN ..157
	nasal rasp MASING242	

nasal septum forceps KNIGHT.....	157	osteotome OBWEGESER.....	234	Q	
nasal septum forceps LUC.....	157	osteotome RUBIN.....	234	QUERVAIN elevator.....	86
nasal septum forceps		osteotome WEST.....	236	QUIRE foreign body lever.....	73
MIDDLETON-JANSEN.....	159	osteotome.....	98	QUISLING mallet.....	260
naso pharyngeal forceps JATHO..	310	osteotome septum SHEEHAN.....	101		
naso pharyngeal forceps		otoscope.....	17		
JURASZ.....	311				
naso pharyngeal forceps					
St. CLAIR-THOMSON.....	310	P		R	
nasolaryngoscope.....	14	palate retractor HOFER.....	289	RAGNELL dissecting scissors.....	191
needle BARBARA ROSEN... 135, 136		palate retractor NAGER.....	289	rasp nasal AUFRICHT.....	239
needle SHAMBOUGH.....	135	PARKES nasal rasp.....	238	rasp nasal COTTLE.....	239
needle injection.....	349	PARTSCH chisel.....	99	rasp nasal DINGMANN.....	244
needle laryngeal.....	352	PARTSCH gouge.....	99	rasp nasal FOMON.....	240, 241
needle tonsil CLAUD.....	285	PARTSCH mallet.....	102, 260	rasp nasal GALLAHER.....	243
needle tonsil DUPUY-WEISS.....	285	PASSOW bone tamper.....	98, 235	rasp nasal LABELLA.....	238
needle tonsil NAGER.....	286	PECK-JOSEPH face lift scissors..	201	rasp nasal JOSEPH.....	238, 239
needle tonsil.....	210, 306, 344	PEET nasal rasp.....	238	rasp nasal LEWIS.....	239
needle holder CRILE-WOOD.....	209	PENNINGTON septum elevator...224		rasp nasal MALTZ.....	238, 239
needle holder DERF.....	209	PERWITZSCHKY		rasp nasal MASING.....	242
needle holder HALSEY.....	209	salival scissors.....	298	rasp nasal PARKES.....	238
needle holder WEBSTER.....	209	pharyngoscope.....	16	rasp nasal PEET.....	238
needle holder		PIERCE septum elevator.....	223	rasp nasal WIENER.....	238
WEBSTER-BABY.....	209	plastic mallet.....	260	raspatory FARABEU.....	90
needle holder laryngeal.....	349	PLESTER suction tube.....	126	raspatory suction GULEN.....	227
needle holder micro		PLESTER hook.....	137	raspatory JANSEN.....	91
BARRAQUER.....	123	PLESTER knife.....	122	raspatory JOSEPH.....	88
needle holder micro		PLESTER retractor.....	112, 264	raspatory KÖNIG.....	86
CASTROVIEJO.....	124	POLITZER tympanum knife.....	70, 71	raspatory LANGENBECK.....	86
NEGUS tonsil forceps.....	281	POLITZER ear specula.....	53	raspatory LEMPERT.....	88
NEGUS knot tier.....	304	POLITZER air bag.....	61	raspatory MILLER.....	92
NEGUS chest support.....	280	polypus laryngeal snare.....	319	raspatory MOLT.....	92
NEIVERT-ANDERSON		POTTS-SMITH dressing forceps...294		raspatory ROSEN.....	93
rhinoplasty chisel.....	233	POTTS-SMITH tissue forceps.....	294	raspatory WILLIGER.....	87
NEWS tracheal hook.....	315	powder blower KABERSKE.....	60	raspatory WULLSTEIN.....	92
noise apparatus BARANY.....	60	powder blower UNIVERSAL.....	60	raspatory.....	86-93, 138, 227
NON STICK bipolar forceps....	40, 41	pressure forceps		REDA cotton applicator.....	64
NOYES nasal dressing forceps....	155	HOUSE-GELFOAM.....	85	REDA sickle knife.....	217
nystagmus spectacle FRENZEL....	22	PRINCE tonsil scissors.....	296	REDA nasal specula.....	144
		probe ear STACKE.....	63	REDA retractor.....	249
		probe lacrimal BOWMAN.....	262	REICHERT epiglottis retractor....	343
		probe salivary duct BOWMAN.....	293	REINER ear syringe.....	61
O		punch HAJEK-KOFLER.....	182, 183	retractor ADSON.....	111
O BRIEN stitch scissors.....	199	punch KERRISON.....	109, 182	retractor ALM.....	109
OBWEGESER osteotome.....	234	punch antrum.....	184, 185	retractor BARSKY.....	248
operating scissors IRIS.....	117, 192	punch biopsy.....	179	retractor BERGMANN.....	250
operating scissors STANDARD....	117	punch bone CITELLI.....	109	retractor BRÜNINGS-BRUNK.....	263
operation laryngoscope		punch bone		retractor COTTLE.....	254
.....	334, 335, 340, 341	FERRIS-SMITH-KERRISON.....	181	retractor FINSSEN.....	109
osteotome COTTLE.....	100	punch circular.....	186	retractor FISCH.....	111, 265
osteotome LEXER.....	228	punch malleus DIETER.....	84	retractor FRAZIER.....	246
osteotome LEXER MINI.....	100	punch tonsil HARTMANN.....	307	retractor FREER.....	254
osteotome MINI-LAMBOTTE				retractor GILLIES.....	254
.....	99, 229			retractor GRAEFE.....	246
				retractor GUTHRIE.....	246

retractor HOLZHEIMER.....	109	rhinoplasty chisel SILVER	233	scissors CONVERSE	194
retractor HUMBY	248	RING tongue depressor.....	272	scissors COTTLE	194
retractor JANSEN	109	RITTER-HALLE sinus dilator.....	261	scissors GRADLE.....	195
retractor JOSEPH.....	247	rod measuring HOUSE.....	132	scissors GRAEFE.....	194
retractor KLEINERT-KUTZ	247	ROEDER "E" tonsil snare.....	303	scissors KNAPP	193
retractor KNAPP.....	250	ROGER septum elevator.....	222	scissors LITTLER	194
retractor		ROLLET retractor	250	scissors STEVENS.....	196
KOCHER-LANGENBECK	263	rongeur bone		scissors WAGNER	197
retractor LAHEY	246	BANE-HARTMANN	106	scissors WALTER.....	194
retractor LEYLA	148	rongeur bone BEYER.....	107	scissors WILMER	194
retractor LUCAE	250	rongeur bone BLUMENTHAL.....	106	scissors blepharoplasty	
retractor MIDDELDORPF	263	rongeur bone BÖHLER	107, 108	GREENBERG-PAR	202
retractor MOLLISON.....	111	rongeur bone		scissors blepharoplasty KAYE.....	202
retractor PLESTER.....	112, 264	COTTLE-KAZANJIAN	108	scissors dissecting GORNEY	116
retractor REDA	249	rongeur bone KLEINERT-KUTZ ..	107	scissors dissecting JAMESON	191
retractor ROLLET	250	rongeur bone LEMPERS	107	scissors dissecting	
retractor ROUX-BABY	263	rongeur bone LUER.....	106	JOSEPH	116, 190
retractor WEITLANER	110	rongeur bone MC INDOE	108	scissors dissecting KELLY.....	191
retractor		rongeur bone ZAUFAL-JANSEN ..	107	scissors dissecting KILNER.....	191
WEITLANER-WULLSTEIN.....	110	ROSEN needle BARBARA... 135, 136		scissors dissecting	
retractor WILLIGER.....	113	ROSEN suction tube	129	METZENBAUM 115, 188, 189, 297	
retractor WULLSTEIN.....	112	ROSEN knife	120, 121	scissors dissecting	
retractor alar CONVERSE.....	252	ROSEN raspatory	93	METZENBAUM FINO.....	115, 189
retractor alar COTTLE.....	252, 253	ROSER-KOENIG mouth gag.....	271	scissors dissecting RAGNELL.....	191
retractor alar		ROUX-BABY retractor	263	scissors dissecting REYNOLDS... 191	
COTTLE-NEIVERT.....	252	RUBIN morselizer forceps.....	161	scissors dissecting	
retractor alar FOMON.....	253	RUBIN osteotome	234	SANVENERO	190
retractor alar KILNER.....	253	RUSSEL-DAVIS tongue blades....	278	scissors dissecting	
retractor cheek STERNBERG	270	RYDEL-SEIFFERT tuning fork	59	STRABISMUS	116, 196
retractor cheek	270			scissors face lift BEUSE.....	201
retractor epiglottis REICHERT.....	343			scissors face lift GORNEY.....	200
retractor finger ring COTTLE	255			scissors face lift	
retractor nasal AUFRICHT.....	251	S		GORNEY-FREEMAN	200
retractor nasal COTTLE	251	salival scissors		scissors face lift KAYE.....	201
retractor nasal MASING	251	PERWITZSCHKY	298	scissors face lift PECK-JOSEPH.. 201	
retractor nasal		salivary duct probe BOWMAN.....	293	scissors laryngeal KILLIAN.....	343
MASING-NEIVERT.....	251	SANVENERO		scissors micro	119, 131, 203-205
retractor palate HOFER.....	289	dissecting scissors.....	190	scissors micro ear BELLUCCI.....	80
retractor palate NAGER.....	289	saw nasal JOSEPH	244, 245	scissors micro ear FISCH.....	82
retractor thyroid SCHOENBORN..	317	saw nasal LINDEMANN	245	scissors micro ear GREVEN	81
retractor uvula LOTHROP	288	SAWTELL tonsil forceps.....	281	scissors micro ear MCGHEE.....	81
retractor uvula LOVE	288	SCHEINMANN tip	354	scissors micro ear SCHUKNECHT.. 81	
REYNOLDS dissecting scissors... 191		SCHINK dermatome	220	scissors micro ear SHEA.....	80
rhinoplasty chisel CINELLI	232	SCHMEDEN		scissors micro ear WULLSTEIN....	83
rhinoplasty chisel COTTLE.....	231	nasal cutting forceps.....	169	scissors nasal CAPLAN.....	206
rhinoplasty chisel FOMON.....	232	SCHNIDT tonsil forceps	281	scissors nasal COTTLE.....	198
rhinoplasty gouge HAJEK.....	236	SCHOENBORN		scissors nasal COTTLE-MASING 198	
rhinoplasty gouge		thyroid retractor	317	scissors nasal FOMON.....	198
KILLIAN-CLAUS	236	SCHUKNECHT		scissors nasal HEYMANN.....	198
rhinoplasty chisel		micro ear scissors.....	81	scissors nasal	187
NEIVERT-ANDERSO	233	SCHUKNECHT bending device ...	85	scissors operating IRIS.....	117, 192
rhinoplasty chisel SHEEHAN.....	232	SCHUKNECHT knife	122	scissors operating STANDARD	117
		SCHUMACHER tip	354		
		scissors BONN	192		

scissors salival			
PERWITZSCHKY	298	SHEEHAN septum osteotome.....	101
scissors stich LITTAUER.....	199	sickle knife REDA.....	217
scissors stich O BRIEN	199	SIEGLE ear specula set	56
scissors stich SPENCER.....	199	SILVER rhinoplasty chisel	233
scissors tonsil BOETTCHER	296	SILVER dermatome	221
scissors tonsil DEAN	296	sinus dilator RITTER-HALLE.....	261
scissors tonsil GOOD	296	SINUS nasal elevator	261
scissors tonsil PRINCE.....	296	SINUS septum elevator.....	223
scissors tumor	207	sinuscope	15
scissors wire UNIVERSAL.....	118, 299	sinuscopy trocar UNIVERSAL.....	214
scissors micro larangeal.....	351	SLUDER-BALLENGER	
SEBILEAU elevator	86	tonsillectome	305
SEIFERT tip	354	snare ear polypus KRAUSE	72
seizing forceps LAHEY	318	snare ear polypus WILDE.....	72
SEMKEN dressing forceps.....	95	snare nasal polypus KRAUSE.....	162
SEMKEN tissue forceps	95	snare nasal polypus	
septum elevator BALLENGER	225	KRAUSE-VOSS.....	162
septum elevator COTTLE.....	224, 225	snare nasal polypus WILDE	163
septum elevator		snare tonsil BRUENINGS.....	301
COTTLE-JOSEPH.....	224	snare tonsil EVES.....	301
septum elevator FREER.....	223	snare tonsil ROEDER "E"	303
septum chisel FREER	230	snare tonsil TYDING.....	300
septum elevator		snare laryngeal polypus.....	319
HAJEK-BALLENGER	225	spare bulb	22
septum elevator HALLE.....	222	spare bulb laryngoscope	332, 333
septum elevator HOWARTH.....	224	specula ear BOUCHERON.....	53
septum elevator JOSEPH.....	222	specula ear GRUBER.....	53
septum elevator KILLIAN.....	223, 225	specula ear HARTMANN.....	53
septum elevator MASING.....	222	specula ear	55, 56
septum elevator McKENTY	222, 224	specula ear FARRIOR.....	54
septum elevator PENNINGTON	224	specula ear POLITZER	53
septum elevator PIERCE.....	223	specula ear TOYNBEE.....	53
septum elevator ROGER.....	222	specula nasal COTTLE	146, 147
septum osteotome SHEEHAN.....	101	specula nasal HARTMANN	142
septum elevator SINUS.....	223	specula nasal	
septum cannula	210, 306, 344	HARTMANN-HALLE.....	141
septum fracture elevator		specula nasal KILLIAN	144, 145
GOLDMANN.....	226	specula nasal REDA.....	144
septum straightening forceps		specula nasal THUDICHUM.....	140
ASCH.....	160	specula nasal TIECK-HALLE	144
septum straightening forceps		specula nasal VOLTOLINI	140
WALSHAM	160	specula nasal WIEN	143
septum swivel knife		SPENCER stich scissors.....	199
BALLENGER.....	218	spoon SHEA.....	134
SEWALL antrum elevator	226	spoon	138
SEXTON tympanum knife	71	spoon ear GROSS.....	65
SHAMBOUGH needle	135	SPRATT bone curette.....	103
SHAPLEIGH ear loop.....	67	spreader tracheal BOSE.....	314, 315
SHEA micro ear scissors.....	80	St. CLAIR-THOMSON	
SHEA spoon	134	adenoid curette.....	309
SHEEHAN rhinoplasty chisel.....	232	St. CLAIR-THOMSON	
		naso pharyngeal forceps	310
		STACKE ear probe.....	63
		STANDARD dressing forceps.....	95
		STANDARD operating scissors....	117
		STERNBERG cheek retractor	270
		STEVENS scissors	196
		stitch scissors LITTAUER.....	199
		stitch scissors O BRIEN	199
		stitch scissors SPENCER.....	199
		stitch bipolar electrode.....	44, 45
		STRABISMUS	
		dissecting scissors.....	116, 196
		STRUYCKEN	
		nasal cutting forceps.....	169
		suction tube BARON	128
		suction tube FERGUSSON	213
		suction tube	
		FRAZIER/FERGUSSON	125, 213
		suction tube PLESTER.....	126
		suction tube ROSEN	129
		suction tube WULLSTEIN.....	127
		suction handle WULLSTEIN.....	129
		suction tube YANKAUER.....	284
		suction tube YANKAUER BABY	284
		suction tube ZÖLLNER.....	125
		suction tube	348
		suction coagulation tube.....	211
		suction monopolar coagulator	43
		suction raspatory GUILLEN.....	227
		suction tube HOUSE	126, 214
		suction bipolar forceps.....	42
		suction laryngeal elevator.....	352
		syringe ear REINER	61
		syringe ear	62
		syringe tonsil	210, 306, 344
		T	
		TABB knife	122
		TAKAHASHI ethmoid forceps.....	165
		tamper	98
		tamper bone PASSOW.....	98, 235
		THILENIUS	
		tonsil abscess forceps	283
		THUDICHUM nasal specula.....	140
		thyroid dissector KOCHER	317
		thyroid retractor SCHOENBORN.....	317
		TIECK-HALLE nasal specula	144
		tier knot NEGUS.....	304
		tier laryngeal knot.....	352
		TILLEY ear forceps.....	74
		TILLEY nasal dressing forceps.....	155
		tip BARACANI	354
		tip BRUENINGS	354

tip CORDES	354	tonsil dissector HURD	290	tube suction	348
tip FRAENKEL	354	tonsil dissector LOPEZ-REINKE	290	tube suction HOUSE	126, 214
tip KRAUSE	354	tonsil forceps MARSCHIK	282	tube tracheal	
tip LANGE	354	tonsil forceps MIKULICZ	283	WAGENER-MOSHER	315
tip SCHEINMANN	354	tonsil needle NAGER	286	tube coagulation suction	211
tip SCHUMACHER	354	tonsil forceps NEGUS	281	tumor scissors	207
tip SEIFERT	354	tonsil scissors PRINCE	296	tuning fork HARTMANN	58
tissue forceps ADSON	97	tonsil snare ROEDER "E"	303	tuning fork LUCAE	59
tissue forceps DERLACKI	97	tonsil forceps SAWTELL	281	tuning fork RYDEL-SEIFFERT	59
tissue forceps POTTS-SMITH	294	tonsil forceps SCHNIDT	281	tuning fork	58, 59
tissue forceps SEMKEN	95	tonsil forceps TYDING	282	TYDING tonsil forceps	282
TOBOLD tongue depressor	270	tonsil snare TYDING	300	TYDING tonsil snare	300
tongue depressor ANDREW	269	tonsil forceps WHITE	281	tympa-num knife LUCAE	70
tongue depressor BRUENINGS	268	tonsil elevator YANKAUER	290	tympa-num knife POLITZER	70, 71
tongue depressor BUCHWALD	268	tonsil wire	302	tympa-num knife SEXTON	71
tongue depressor		tonsil syringe	210, 306, 344		
CAWOOD-MINNESOTA	268	tonsil needle	210, 306, 344		
tongue depressor		tonsil abscess forceps		U	
DAVIS-BOYLE	273	THILENIUS	283	UCKERMANN cotton applicator	64
tongue blades DOUGHTY	279	tonsillectome		UNIVERSAL wire scissors	118, 299
tongue depressor FRENZEL	268	SLUDER-BALLENGER	305	UNIVERSAL trocar sinuscopy	214
tongue depressor HARTMANN	269	TOYNBEE ear specula	53	UNIVERSAL powder blower	60
tongue depressor KROENIG	268	tracheal spreader BOSE	314, 315	uvula retractor LOTHROP	288
tongue depressor		tracheal cannula		uvula retractor LOVE	288
MORITZ-SCHMIDT	269	CHEVALIER-JACKSON	316		
tongue depressor RING	272	tracheal hook ITERSON	315	V	
tongue blades RUSSEL-DAVIS	278	tracheal hook JACKSON	314	VOLKMANN bone curette	104
tongue depressor TOBOLD	270	tracheal dilator LABORDE	314	VOLTOLINI nasal specula	140
tongue depressor WIEDER	269	tracheal cannula LUER	316		
tongue forceps YOUNG	270	tracheal hook NEWS	315	W	
tongue depressor	268	tracheal dilator TROUSSEAU	314	WAGENER ear hook	66
tongue forceps COLLIN	270	tracheal dilator		WAGENER-MOSHER	
tonsil forceps ABRAHAM	282	TROUSSEAU-BABY	314	tracheal tube	315
tonsil knife ABRAHAM	287	tracheal tube		WAGNER scissors	197
tonsil dissector ALDERDYCE	290	WAGENER-MOSHER	315	WALSHAM septum straightening	
tonsil forceps BALLENGER	281	trocar COAKLEY	215	forceps	160
tonsil forceps BLOHMKE	281	trocar LICHTWITZ	215	WALTER chisel	235
tonsil scissors BOETTCHER	296	trocar sinuscopy UNIVERSAL	214	WALTER scissors	194
tonsil knife BRUENINGS	287	TROELTSCH nasal forceps	149	WATSON dermatome	221
tonsil snare BRUENINGS	301	TROUSSEAU tracheal dilator	314	WATSON-WILLIAMS	
tonsil knife CANFIELD	287	TROUSSEAU-BABY		ethmoid forceps	166
tonsil enucleator CARPENTER	291	tracheal dilator	314	WEBER-LOCH ear loop	67
tonsil needle CLAUS	285	tube suction BARON	128	WEBSTER needle holder	209
tonsil forceps COLVER	281	tube suction FERGUSSON	213	WEBSTER-BABY needle holder	209
tonsil scissors DEAN	296	tube suction		WEIL-BLAKESLEY	
tonsil forceps DENIS BROWNE	283	FRAZIER/FERGUSSON	125, 213	ethmoid forceps	164
tonsil needle DUPUY-WEISS	285	tube suction PLESTER	126	WEIL-BLAKESLEY	
tonsil snare EVES	301	tube suction ROSEN	129	nasal cutting forceps	168
tonsil knife FISHER	286	tube suction WULLSTEIN	127	WEITLANER retractor	110
tonsil scissors GOOD	296	tube suction YANKAUER	284	WEITLANER-WULLSTEIN	
tonsil punch HARTMANN	307	tube suction YANKAUER BABY	284	retractor	110
tonsil elevator HENKE	290	tube suction ZÖLLNER	125	WEST gouge	236
				WEST osteotome	236

WESTMACOTT	
nasal dressing forceps.....	154
WHITE tonsil forceps.....	281
WIEDER tongue depressor.....	269
WIEN nasal specula.....	143
WIENER nasal rasp.....	238
WILDE ear polypus snare.....	72
WILDE nasal polypus snare.....	163
WILDE (TROELTSCH)	
ear forceps.....	94
WILDE (TROELTSCH)	
nasal forceps.....	152
WILDER lachrymal dilator.....	261
WILLIGER bone curette.....	105
WILLIGER raspatory.....	87
WILLIGER retractor.....	113
WILMER scissors.....	194
wire scissors UNIVERSAL.....	118, 299
wire tonsil.....	302
WULLSTEIN suction handle.....	129
WULLSTEIN micro ear scissors.....	83
WULLSTEIN suction tube.....	127
WULLSTEIN knife.....	122
WULLSTEIN raspatory.....	92
WULLSTEIN retractor.....	112
Y	
YANKAUER tonsil elevator.....	290
YANKAUER suction tube.....	284
YANKAUER BABY suction tube.....	284
YASARGIL ear specula holder.....	57
YOUNG tongue forceps.....	270
Z	
ZAUFAL ear loop.....	65
ZAUFAL-JANSEN ear elevator.....	65
ZAUFAL-JANSEN bone rongeur.....	107
ZIEGLER head mirror.....	23
ZÖLLNER suction tube.....	125
bipolar cable.....	39
light guide cable.....	19
laryngeal cannula.....	210, 306, 344
septum cannula.....	210, 306, 344
cotton carrier.....	347
antrum curette.....	256, 257
tongue depressor.....	268
biopsy forceps.....	15
bipolar forceps.....	36, 37, 38
dressings forceps.....	295
jeweler forceps.....	96
maxillary sinus forceps.....	176, 177
micro ear forceps.....	75, 76, 77, 78, 79
nasal forceps.....	167, 180
nasal cutting forceps.....	170-174, 178
tuning fork.....	58, 59
laryngeal handle.....	346
laryngoscope handle.....	332, 333
ear hook.....	65, 66
laryngeal hook.....	352, 353
laryngeal instrument handle.....	353
laryngeal knife.....	352, 353
fibreglass laryngoscope.....	339
operation laryngoscope.....	334, 335, 340, 341
laryngeal mirror.....	346
injection needle.....	349
laryngeal needle.....	352
tonsil needle.....	210, 306, 344
laryngeal needle holder.....	349
FRENZEL nystagmus spectacle.....	22
mallet plastic.....	260
antrum punch.....	184, 185
biopsy punch.....	179
circular punch.....	186
cheek retractor.....	270
micro scissors.....	119, 131, 203-205
nasal scissors.....	187
tumor scissors.....	207
laryngoscope spare bulb.....	332, 333
ear specula.....	55, 56
ear syringe.....	62
tonsil syringe.....	210, 306, 344
suction tube.....	348
tonsil wire.....	302

A			
ABRAHAM bisturi	287	ANTRUM cureta	256
ABRAHAM pinza	282	articulacion	335
abre-boca	271, 274-277, 280	articulacion esferica.....	148
abre-boca BOYLE-DAVIS.....	274	asa.....	65, 67, 72, 163
abre-boca DAVIS-BOYLE.....	274	asa BILLEAU	65
abre-boca DAVIS-MEYER.....	277	asa LANGENBECK	65
abre-boca DENHART.....	271	asa LOCH-WEBER	67
abre-boca DINGMANN.....	276	asa SHAPLEIGH	67
abre-boca DOUGHTY-KILNER	275	asa WEBER-LOCH	67
abre-boca		ASCH pinza	160
DOYEN-JANSEN (MOLT)	271	AUFRICHT escofina	239
abre-boca HEISTER.....	271	AUFRICHT retractor.....	251
abre-boca		auricular especulo	53-56
JANSEN-DOYEN (MOLT)	271	auricular pinza	74-79
abre-boca JENNINGS	271	B	
abre-boca KILNER-DOUGHTY	275	BABY ROUX separador	263
abre-boca KOENIG-ROSER	271	BABY-TROUSSEAU dilatador.....	314
abre-boca MAUNDER	280	BABY-WEBSTER porta aguja	209
abre-boca McIVOR.....	277	BABY-YANKAUER	
abre-boca MEYER-DAVIS.....	277	tubo de succion	284
abre-boca		baja nudos.....	352
MOLT (DOYEN-JANSEN)	271	baja-lengua	
abre-boca ROSER-KOENIG	271	268-270, 272-273, 275-279
acoplamiento	148	baja-lengua ANDREW	269
adaptador	20, 24-25, 129	baja-lengua BOYLE-DAVIS	273
adaptador HOUSE.....	129	baja-lengua BRUENINGS	268
adenotomo LAFORCE.....	309	baja-lengua BUCHWALD	268
ADSON pinza	97	baja-lengua DAVIS-BOYLE	273
ADSON separador.....	112	baja-lengua DAVIS-RUSSEL.....	278
aguja	70-71, 135-136, 210,	baja-lengua DINGMANN	276
.....	285-286, 306, 344, 352-353	baja-lengua DOUGHTY	279
aguja BARBARA / ROSEN ...	135, 136	baja-lengua DOUGHTY-KILNER	275
aguja CLAUUS.....	285	baja-lengua FRENZEL	268
aguja DUPUY-WEISS.....	285	baja-lengua HARTMANN	269
aguja LUCAE.....	70	baja-lengua KILNER-DOUGHTY	275
aguja NAGER	286	baja-lengua KROENING.....	268
aguja POLITZER	70-71	baja-lengua McIVOR	277
aguja ROSEN / BARBARA... 135, 136		baja-lengua MORITZ-SCHMIDT	269
aguja WEISS-DUPUY	285	baja-lengua RUSSEL-DAVIS.....	278
alambre para polipotomo.....	319	baja-lengua SCHMIDT-MORITZ.....	269
ALDERDYCE elevador.....	290	baja-lengua TOBOLD	270
ALM separador	110	baja-lengua WIEDER	269
amigdalotomo		BALLENGER bisturi	218
BALLENGER-SLUDER	305	BALLENGER elevador	225
amigdalotomo		BALLENGER pinza	281
SLUDER-BALLENGER	305	BALLENGER-HAJEK elevador	225
ANDERSON-NEIVERT		BALLENGER-SLUDER	
osteotomo.....	233	amigdalotomo.....	305
ANDREW baja-lengua.....	269	BANE-HARTMANN pinza gubia... 106	
anillo	335	BARACANI punta	354
anteojos FRENZEL.....	22	BARANY ensordecedor.....	60
		BARBARA / ROSEN aguja... 135, 136	
		BARBARA gancho.....	135, 136
		BARBON-LUBET pinza	154
		BARNHILL cuchillo	308
		BARON tubo de aspiracion	128
		BARRAQUER porta aguja.....	123
		BARSKY gancho	248
		BARTH cucharilla	104
		BECKMANN cuchillo	308
		BELLUCCI tijera	80
		BERGMANN gancho	250
		BEUSE tijera.....	201
		BEYER pinza gubia	107
		BILLEAU asa.....	65
		bipolar cable.....	39
		bipolar electrodo.....	44-45
		bipolar pinza	36-38, 40-42
		bipolar pinza de succion.....	42
		bisturi	216-219, 286-287
		bisturi ABRAHAM	287
		bisturi BALLENGER	218
		bisturi BRUENINGS.....	287
		bisturi CANFIELD	287
		bisturi CONVERSE.....	217
		bisturi COTTLE.....	217
		bisturi FISHER.....	286
		bisturi FREER.....	216
		bisturi JOSEPH.....	216-217
		bisturi REDA.....	217
		BLAKESLEY pinza	180
		BLAKESLEY-WEIL pinza.....	164, 168
		BLOHMKE pinza	281
		BLUMENTHAL pinza gubia	106
		BOETTCHEER tijera	296
		BÖHLER pinza gubia	107-108
		BOIES elevador.....	226
		bombilla	22, 26, 27, 332-333
		BONN tijera	192
		BOSE gancho.....	315
		BOSE separador	314
		BOUCHERON especulo auricular	53
		BOWMAN sonda	262, 293
		BOYLE-DAVIS abre-boca.....	274
		BOYLE-DAVIS baja-lengua	273
		brazo de soporte.....	148
		brazo flexible	57
		broca.....	30-31
		broncoscopio	18
		BROWNE DENIS pinza.....	283
		BRUENINGS baja-lengua	268
		BRUENINGS bisturi.....	287
		BRUENINGS cierranudo	301

BRUENINGS espejuelo auricular ...55	cincel WEST236	cuchillo BECKMANN308
BRUENINGS pinza.....158	CINELLI cincel.....232	cuchillo FREER-INGALS219
BRUENINGS punta.....354	cinta.....23	cuchillo INGALS-FREER219
BRUENINGS tubo de extension...354	CITELLI pinza sacabocado109	cuchillo MASING219
BRÜNINGS-BRUNK separador ...263	CLAR lampara frontal.....26	cuchillo PLESTER122
BRÜNINGS-LUCAS gubia.....98	CLAUS aguja.....285	cuchillo POLITZER.....71
BRUNK-BRÜNINGS separador...263	CLAUS-KILLIAN cincel.....236	cuchillo ROSEN.....120
BUCHWALD baja-lengua268	coagulador de succion monopolar..43	cuchillo SCHUKNECHT.....122
BUCK cureta68-69	COAKLEY cureta.....256	cuchillo SEXTON.....71
BUCK elevador.....73	COAKLEY trocar215	cuchillo St. CLAIR-THOMSON309
	COLLIN pinza270	cuchillo TABB122
C	COLVER pinza281	cuchillo THOMSON-St. CLAIR309
cable.....19, 39	cono.....61	cuchillo WULLSTEIN122
cable bipolar39	CONVERSE bisturi.....217	cureta65, 68-69, 133, 256
CANFIELD bisturi.....287	CONVERSE gancho.....252	cureta ANTRUM256
canula CHEVALIER-JACKSON...316	CONVERSE/WILMER/	cureta BUCK.....68-69
canula de inyeccion.....337, 349	WALTER tijera194	cureta COAKLEY.....256
canula de succion.....338	CORDES punta354	cureta FAULKNER.....256
canula JACKSON-CHEVALIER...316	COTTLE (MALTZ) escofina.....239	cureta HOUSE133
canula LUER316	COTTLE bisturi.....217	cureta y gancho GROSS65
canula MOSHER-WAGENER315	COTTLE cincel100, 231	
canula para laringe.....210, 306, 344	COTTLE elevador.....224-225	D
canula traqueal315-316	COTTLE espejuelo nasal146-147	DAUBENSPECK cucharilla258
canula WAGENER-MOSHER315	COTTLE gancho252-255	DAVIS-BOYLE abre-boca.....274
CAPLAN tijera206	COTTLE machacadora.....237	DAVIS-BOYLE baja-lengua273
CARPENTER disector.....291	COTTLE martillo.....102, 260	DAVIS-MEYER abre-boca277
CARPENTER enucleador.....291	COTTLE pinza.....94, 152-153	DAVIS-RUSSEL baja-lengua278
CASTROVIEJO porta aguja124	COTTLE retractor.....251	DAY gancho.....66
cateter.....70	COTTLE tijera.....194, 198	DEAN tijera296
cateter HARTMANN70	COTTLE-KAZANJIAN	DENHART abre-boca271
CAWOOD-MINNESOTA	pinza gubia108, 208	DENIS BROWNE pinza283
separador268	COTTLE-MASING tijera198	depresor REICHERT343
CHEVALIER-JACKSON canula...316	COTTLE-NEIVERT gancho.....252	DERF porta aguja209
CHEVALIER-JACKSON pinza	CRAIG pinza.....158	DERLACKI pinza.....97
para bronco-esofagoscopia356	CRAIG-DOMNICK pinza158	dermatomo HUMBY221
cierranudo.....300-301, 303, 319	CRILE-WOOD porta aguja209	dermatomo SCHINK.....220
cierranudo BRUENINGS301	cucharilla	dermatomo SILVER.....221
cierranudo EVES301103-105, 134, 138, 257-258	dermatomo WATSON221
cierranudo ROEDER "E"303	cucharilla BARTH104	diapason.....58-59
cierranudo TYDING.....300	cucharilla DAUBENSPECK258	diapason LUCAE.....59
cincel98-100, 230-233, 235-236	cucharilla HALLE104, 258	diapason RYDEL-SEIFFERT.....59
cincel CINELLI.....232	cucharilla JANSEN103	DIETER pinza.....84
cincel CLAUS-KILLIAN.....236	cucharilla LEMPERS103	dilatador261, 314
cincel COTTLE100, 231	cucharilla MARTINI.....105	dilatador BABY-TROUSSEAU.....314
cincel FOMON.....232	cucharilla para antro257	dilatador LABORDE.....314
cincel FREER100, 230, 236	cucharilla SHEA.....134	dilatador TROUSSEAU314
cincel HAJEK.....236	cucharilla SPRATT103	dilatador TROUSSEAU-BABY.....314
cincel KILLIAN-CLAUS.....236	cucharilla VOLKMANN104	dilatador WILDER.....261
cincel PARTSCH99	cucharilla WILLIGER105	DINGMAN lima130, 244
cincel PASSOW.....98, 235	cuchillo.....71, 120-122, 219,	DINGMANN abre-boca.....276
cincel SILVER.....233308-309, 352-353	DINGMANN baja-lengua276
cincel WALTER.....235	cuchillo BARNHILL308	disector.....93, 290-291

disector CARPENTER.....	291	elevador SEWALL	226	espejo laringeal MICHEL.....	345
disector FISCH	93	elevador SINUS.....	223	estuche diagnostico.....	48-52
disector HURD.....	290	elevador YANKAUER	290	estuche diagnostico ECO.....	51
disector LOPEZ-REINKE.....	290	elevador ZAUFAL	65	estuche diagnostico RI-MINI	52
disector REINKE-LOPEZ.....	290	elevador ZAUFAL-JANSEN.....	65	estuche diagnostico UNI III.....	50
dispositivo de fijacion para tubos		endolaringeal endoscopio.....	18	EVES cierranudo.....	301
.....	57, 148	endoscopio	15-18		
dispositivo para modelar		endoscopio endolaringeal.....	18	F	
SCHUKNECHT.....	85	ensordecador BARANY.....	60	FARABEUf periostotomo.....	90
DOMNICK-CRAIG pinza	158	enucleador CARPENTER.....	291	faringscopio	16
DOUGHTY baja-lengua.....	279	escofina	238-244	FARRELL porta-algodon	63
DOUGHTY-KILNER abre-boca	275	escofina AUFRIcHT	239	FARRIOR especulo auricular	54
DOUGHTY-KILNER baja-lengua	275	escofina COTTLE (MALTZ).....	239	FAULKNER cureta.....	256
DOYEN-JANSEN (MOLT)		escofina FOMON.....	240-241	FEIN porta-algodon	347
abre-boca	271	escofina GALLAHER	243	FERGUSSON / FRAZIER	
DUPLAY pinza.....	295	escofina GLABELLA	238	tubo de aspiracion	125, 213
DUPUY-WEISS aguja.....	285	escofina JOSEPH.....	238	FERGUSSON tubo de aspiracion	213
		escofina JOSEPH (LEWIS).....	239	FERRIS-SMITH-KERRISON	
E		escofina LEWIS (JOSEPH).....	239	pinza	181
ECO estuche diagnostico	51	escofina MALTZ.....	238	FINSEN separador	110
EICKEN (KILLIAN)		escofina MALTZ (COTTLE).....	239	FISCH disector	93
tubo de aspiracion	212	escofina MASING	242	FISCH separador.....	112, 265
Electrocirugia.....	34-38, 40-45	escofina PARKES.....	238	FISCH tijera	82
electrodo	34-35, 44-45	escofina PEET.....	238	FISHER bisturi.....	286
electrodo bipolar	44-45	escofina WIENER	238	FOMON cincel.....	232
electrodo bipolar MICRODOME	45	especulo auricular	53-56	FOMON escofina.....	240-241
elevador	65, 73, 86, 88, 91-92,	especulo auricular BOUCHERON	53	FOMON gancho	253
.....	138, 222-226, 290	especulo auricular BRUENINGS.....	55	FOMON tijera	198
elevador ALDERDYCE.....	290	especulo auricular FARRIOR	54	FRAENKEL pinza	342
elevador BALLENGER	225	especulo auricular GRUBER.....	53	FRAENKEL punta.....	354
elevador BALLENGER-HAJEK	225	especulo auricular HARTMANN	53	FRAZIER / FERGUSSON	
elevador BOIES.....	226	especulo auricular POLITZER.....	53	tubo de aspiracion	125, 213
elevador BUCK.....	73	especulo auricular SIEGLE	56	FRAZIER gancho	246
elevador COTTLE.....	224-225	especulo auricular TOYNBEE	53	FREEMAN-GORNEY tijera	200
elevador FREER.....	91, 223	especulo nasal	140-147	FREER bisturi.....	216
elevador GOLDMANN.....	226	especulo nasal COTTLE	146-147	FREER cincel.....	100, 230, 236
elevador HAJEK-BALLENGER	225	especulo nasal		FREER elevador.....	91, 223
elevador HALLE	222	HALLE-HARTMANN.....	141	FREER gancho.....	254
elevador HENKE	290	especulo nasal HALLE-TIECK	144	FREER-INGALS cuchillo	219
elevador HOWARTH	224	especulo nasal HARTMANN	142	FRENZEL anteojos.....	22
elevador JANSEN-ZAU FEL.....	65	especulo nasal		FRENZEL baja-lengua	268
elevador JOSEPH	222	HARTMANN-HALLE.....	141	FROHN porta-algodon	63
elevador KILLIAN	223, 225	especulo nasal KILLIAN	144-145	frontal lampara.....	24-27
elevador LEMPERT.....	88, 91	especulo nasal Mod. WIEN	143	FRONTAL sonda	261
elevador MASING.....	222	especulo nasal REDA.....	144		
elevador McKENTY	92, 222, 224	especulo nasal THUDICHUM.....	140	G	
elevador PENNINGTON	224	especulo nasal TIECK-HALLE	144	GALLAHER escofina.....	243
elevador PIERCE	223	especulo nasal VOLTOLINI	140	gancho	65, 66, 135-137, 246-250,
elevador QUERVAIN	86	especulo nasal WIEN Mod.	143	252-255, 314-315, 352-353
elevador QUIRE	73	espejo	23, 26	gancho BARBARA	135, 136
elevador ROGER.....	222	espejo frontal ZIEGLER.....	23	gancho BARSKY	248
elevador SEBILEAU	86	espejo laringeal	345-346	gancho BERGMANN.....	250

gancho BOSE	315	gubia LEXER MINI	100	HOUSE-GELFOAM pinza	85
gancho CONVERSE	252	gubia LUCAS-BRÜNING'S	98	HOWARTH elevador	224
gancho COTTLE	252-255	gubia MINI LEXER	100	HUBER mango	354
gancho COTTLE-NEIVERT	252	gubia PARTSCH	99	HUMBY dermatomo	221
gancho DAY	66	GUILEN legra	227	HUMBY gancho	248
gancho FOMON	253	GUILEN periostotomo	227	HURD disector	290
gancho FRAZIER	246	GUTHRIE gancho	246		
gancho FREER	254			I	
gancho GILLIES	254	H		INGALS-FREER cuchillo	219
gancho GRAEFE	246	HAJEK cincel	236	instrumento de aspiracion y	
gancho GUTHRIE	246	HAJEK martillo	102	irrigacion	210-211
gancho HUMBY	248	HAJEK-BALLENGER elevador	225	instrumento para laringoscopia	
gancho ITERSON	315	HAJEK-KOFLER pinza	182-183	352-353
gancho JACKSON	314	HALLE cucharilla	104, 258	insuflador de aire POLITZER	61
gancho JOSEPH	247	HALLE elevador	222	IRIS tijera	117, 192
gancho KILNER	253	HALLE-HARTMANN		ITERSON gancho	315
gancho KLEINERT-KUTZ	247	especulo nasal	141		
gancho KNAPP	250	HALLE-RITTER sonda	261	J	
gancho KUTZ-KLEINERT	247	HALLE-TIECK especulo nasal	144	JACKSON gancho	314
gancho LAHEY	246	HALSEY porta aguja	209	JACKSON laringoscopio	340
gancho LANGE	255	HARTMANN baja-lengua	269	JACKSON pinza laríngea	343
gancho LUCAE	66, 250	HARTMANN cateter	70	JACKSON-CHEVALIER canula	316
gancho McGEE	136	HARTMANN especulo auricular	53	JACKSON-CHEVALIER pinza	
gancho NEIVERT-COTTLE	252	HARTMANN especulo nasal	142	para bronco-esofagoscopia	356
gancho NEWS	315	HARTMANN pinza		JAMESON (REYNOLDS) tijera	191
gancho PLESTER	137	74-75, 154, 169, 175, 307	JANSEN cucharilla	103
gancho REDA	249	HARTMANN-BANE pinza gubia	106	JANSEN periostotomo	91
gancho ROLLET	250	HARTMANN-HALLE		JANSEN pinza	150
gancho SHAMBAUGH	135	especulo nasal	141	JANSEN separador	110
gancho WAGENER	66	HARTMANN-HOFFMANN		JANSEN-DOYEN (MOLT)	
gancho y cureta GROSS	65	pinza	75, 175	abre-boca	271
GELFOAM-HOUSE pinza	85	HARTMANN-WEINGÄRTNER		JANSEN-GRUENWALD pinza	150
GERZOG martillo	259	pinza	75	JANSEN-MIDDLETON pinza	159
GILLIES gancho	254	HARTMANN-WULLSTEIN		JANSEN-ZAUFAL elevador	65
GILLIES pinza	151	pinza	75, 175	JANSEN-ZAUFAL pinza gubia	107
GLABELLA escofina	238	HEISTER abre-boca	271	JATHO pinza naso-faríngea	310
GOLDMANN elevador	226	HENKE elevador	290	JENNINGS abre-boca	271
GOOD tijera	296	HEYMAN tijera	198	jeringa	61-62, 210, 306, 344
GORNEY tijera	116, 200	HEYMANN pinza	157	jeringa REINER	61
GORNEY-FREEMAN tijera	200	HEYMANN-KNIGHT pinza	156	JOBSON-HORNE porta-algodon	64
GRADLE tijera	195	hilo para amígdalas	302	JOSEPH (LEWIS) escofina	239
GRAEFE gancho	246	HOFER separador	289	JOSEPH bisturi	216-217
GRAEFE pinza	95, 151	HOFFMANN-HARTMANN		JOSEPH elevador	222
GRAEFE tijera	194	pinza	75, 175	JOSEPH escofina	238
grapa para iluminacion	338, 341	hoja de repuesto	220-221	JOSEPH gancho	247
GREENBERG-PAR tijera	202	HOLINGER laringoscopio	339	JOSEPH periostotomo	88
GREVEN tijera	81	HOLZHEIMER separador	110	JOSEPH sierra nasal	244-245
GROSS gancho y cureta	65	horquilla NEGUS	304	JOSEPH tijera	116, 190
GRUBER especulo auricular	53	HOUSE adaptador	129	JOSEPH-PECK tijera	201
GRUENWALD-JANSEN pinza	150	HOUSE cureta	133	JURASZ pinza	311, 342
gubia	98-100	HOUSE sonda	132		
gubia BRÜNING'S-LUCAS	98	HOUSE tubo de aspiracion	126, 214		

K

KABIERSKE lanzapolvo	60
KAYE tijera	201-202
KAZANJIAN-COTTLE	
pinza gubia	108, 208
KELLY tijera	191
KERRISON	
pinza sacabocado.....	109, 182
KERRISON-FERRIS-SMITH	
pinza	181
KILLIAN (EICKEN)	
tubo de aspiracion	212
KILLIAN elevador	223, 225
KILLIAN especulo nasal	144-145
KILLIAN porta-algodon	347
KILLIAN tijera	343
KILLIAN tubo de aspiracion	212
KILLIAN-CLAUS cincel.....	236
KILNER (RAGNELL) tijera.....	191
KILNER gancho.....	253
KILNER-DOUGHTY abre-boca	275
KILNER-DOUGHTY baja-lengua.....	275
KLEINERT-KUTZ gancho.....	247
KLEINERT-KUTZ pinza gubia	107
KNAPP gancho.....	250
KNAPP tijera.....	193
KNIGHT pinza	157
KNIGHT-HEYMANN pinza	156
KOCHER sonda	317
KOCHER-LANGENBECK	
separador	263
KOENIG-ROSER abre-boca	271
KOFLER-HAJEK pinza.....	182-183
KÖNIG periostotomo	86
KRAUSE polipotomo	72, 162
KRAUSE punta.....	354
KRAUSE-VOSS polipotomo	162
KROENING baja-lengua.....	268
KUTZ-KLEINERT gancho.....	247
KUTZ-KLEINERT pinza gubia	107

L

LABORDE dilatador.....	314
LAFORCE adenotomo.....	309
LAHEY gancho	246
LAHEY pinza	318
LAMBOTTE-MINI osteotomo.....	99, 229
lampara frontal.....	24-27
lampara frontal CLAR.....	26
LANGE gancho.....	255
LANGE punta	354
LANGENBECK asa	65

LANGENBECK periostotomo	86
LANGENBECK-KOCHER	
separador	263
lanzapolvo	60
lanzapolvo KABIERSKE	60
lanzapolvo UNIVERSAL	60
laringoscopia	17
laringoscopia . 322-331, 334, 339-341	
laringoscopia HOLINGER.....	339
laringoscopia JACKSON	340
laringoscopia McCoy	324, 331
laringoscopia McIntosh	322-323, 327-328
laringoscopia MILLER	325-326, 329-330
laringoscopia operativo	334-335, 340-341
lazo	65, 67
legra de succion	353
legra GUILLEN	227
LEMPERT cucharilla	103
LEMPERT elevador.....	88, 91
LEMPERT pinza gubia	107
LEWIS (JOSEPH) escofina	239
LEXER MINI gubia	100
LEXER MINI osteotomo	100
LEXER osteotomo	228
LEYLA separador	148
LICHTWITZ trocar	215
lima	130, 238-244
lima DINGMAN	130, 244
LINDEMANN sierra nasal.....	245
LISTER (SINUS) pinza.....	155
LITTAUER pinza.....	74, 156
LITTAUER tijera.....	199
LITTLER tijera	194
LOCH-WEBER asa	67
LOPEZ-REINKE disector.....	290
LOTHROP separador	288
LOVE separador	288
LUBET-BARBON pinza	154
LUC pinza	157
LUCAE aguja.....	70
LUCAE diapason.....	59
LUCAE gancho	66, 250
LUCAE pinza	94, 152
LUCAS-BRÜNINGS gubia.....	98
LUER canula	316
LUER pinza gubia.....	106
LUNIATSCHEK tamponador	292

M

machacadora COTTLE.....	237
MALTZ (COTTLE) escofina	239
MALTZ escofina.....	238
mango de pila	332-333
mango de succion	127, 129
mango de succion	
WULLSTEIN.....	127, 129
mango HUBER.....	354
mango para espejo laringeal	346
mango para instrumentos	
microlaringeos	353
mango para laringoscopia	332-333, 336
MARSCHIK pinza	282
martillo.....	102, 259-260
martillo COTTLE.....	102, 260
martillo GERZOG	259
martillo HAJEK	102
martillo MEAD	102, 259
martillo PARTSCH	102, 260
martillo QUISLING.....	260
MARTINI cucharilla.....	105
MASING cuchillo	219
MASING elevador.....	222
MASING escofina	242
MASING-COTTLE tijera	198
MASING-NEIVERT retractor	251
MASTIN pinza	318
MAUNDER abre-boca	280
MC INDOE pinza gubia	108, 208
McGEE gancho	136
McGEE tijera	81
McINDOE pinza.....	151
McIVOR abre-boca	277
McIVOR baja-lengua	277
McKENTY elevador	92, 222, 224
MEAD martillo.....	102, 259
METZENBAUM FINO tijera ..	115, 189
METZENBAUM tijera	
.....	115, 188-189, 297
MEYER-DAVIS abre-boca.....	277
MICHEL espejo laringeal	345
micro pinza	131, 350-351
micro tijera	119, 131, 203-205, 351
MICRODOME electrodo bipolar	45
MIDDELDORPF separador	263
MIDDLETON-JANSEN pinza	159
MIKULICZ pinza	283
MILLER periostotomo	92
MINI LEXER gubia	100
MINI LEXER osteotomo	100

MINI-LAMBOTTE osteotomo..99, 229	PARTSCH gubia.....99	pinza GRUENWALD-JANSEN 150
MINNESOTA-CAWOOD	PARTSCH martillo 102, 260	pinza gubia106-108
separador268	PASSOW cincel.....98, 235	pinza gubia BANE-HARTMANN... 106
Mod. WIEN espejito nasal 143	PECK-JOSEPH tijera 201	pinza gubia BEYER 107
MOLLISON separador..... 112	PEET escofina.....238	pinza gubia BLUMENTHAL..... 106
MOLT (DOYEN-JANSEN)	PENNINGTON elevador.....224	pinza gubia BÖHLER 107-108
abre-boca271	pera de goma61	pinza gubia
MOLT periostotomo.....92	periostotomo.....86-93, 138, 227, 353	COTTLE-KAZANJIAN 108, 208
monopolar coagulador de succion..43	periostotomo FARABEUF.....90	pinza gubia HARTMANN-BANE... 106
MORITZ-SCHMIDT baja-lengua ..269	periostotomo GUILLEN227	pinza gubia JANSEN-ZAUFAL 107
MOSHER-WAGENER canula315	periostotomo JANSEN.....91	pinza gubia
N	periostotomo JOSEPH88	KAZANJIAN-COTTLE 108, 208
NAGER aguja.....286	periostotomo KÖNIG86	pinza gubia KLEINERT-KUTZ 107
NAGER separador.....289	periostotomo LANGENBECK86	pinza gubia KUTZ-KLEINERT 107
nasolarinoscopio..... 14	periostotomo MILLER.....92	pinza gubia LEMPERT 107
NEGUS horquilla304	periostotomo MOLT92	pinza gubia LUER..... 106
NEGUS pinza281	periostotomo ROSEN.....93	pinza gubia MC INDOE 108, 208
NEGUS soporte de pecho280	periostotomo WILLIGER.....87	pinza gubia ZAUFAL-JANSEN 107
NEIVERT-ANDERSON	periostotomo WULLSTEIN92	pinza HAJEK-KOFLER.....182-183
osteotomo.....233	PERWITZSCHKY298	pinza HARTMANN
NEIVERT-COTTLE gancho252	PIERCE elevador22374-75, 154, 169, 175, 307
NEIVERT-MASING retractor251	pinza ABRAHAM282	pinza
NEWS gancho.....315	pinza ADSON97	HARTMANN-HOFFMANN.....75, 175
NOYES pinza 155	pinza ASCH 160	pinza
O	pinza auricular ... 74-79, 84-85, 94-97	HARTMANN-WEINGÄRTNER75
O'BRIEN tijera 199	pinza BALLENGER281	pinza
OBWEGESER osteotomo234	pinza BARBON-LUBET 154	HARTMANN-WULLSTEIN75, 175
oftalmoscopio UNI II49	pinza bipolar 36-38, 40-42	pinza HEYMANN 157
optica pinza 15	pinza BLAKESLEY 180	pinza HEYMANN-KNIGHT 156
osteotomo	pinza BLAKESLEY-WEIL..... 164, 168	pinza
.....99-101, 228-229, 233-234	pinza BLOHMKE281	HOFFMANN-HARTMANN.....75, 175
osteotomo	pinza BROWNE DENIS.....283	pinza HOUSE-GELFOAM85
ANDERSON-NEIVERT233	pinza BRUENINGS.....158	pinza JANSEN 150
osteotomo LAMBOTTE-MINI..99, 229	pinza circular 186	pinza JANSEN-GRUENWALD 150
osteotomo LEXER228	pinza COLLIN.....270	pinza JANSEN-MIDDLETON 159
osteotomo LEXER MINI 100	pinza COLVER281	pinza JURASZ..... 311, 342
osteotomo MINI LEXER 100	pinza COTTLE.....94, 152-153	pinza
osteotomo MINI-LAMBOTTE..99, 229	pinza CRAIG158	KERRISON-FERRIS-SMITH 181
osteotomo	pinza CRAIG-DOMNICK 158	pinza KNIGHT 157
NEIVERT-ANDERSON.....233	pinza de diseccion.....95	pinza KNIGHT-HEYMANN 156
osteotomo OBWEGESER234	pinza de succion bipolar42	pinza KOFLER-HAJEK.....182-183
osteotomo RUBIN.....234	pinza DENIS BROWNE.....283	pinza LAHEY318
osteotomo SHEEHAN 101, 232	pinza DERLACKI.....97	pinza laringeal JACKSON 343
otoscopio 17, 48	pinza DIETER.....84	pinza LISTER (SINUS)..... 155
otoscopio UNI I48	pinza DOMNICK-CRAIG 158	pinza LITTAUER.....74, 156
P	pinza DUPLAY.....295	pinza LUBET-BARBON 154
PAR-GREENBERG tijera202	pinza	pinza LUC 157
PARKES escofina.....238	FERRIS-SMITH-KERRISON 181	pinza LUCAE94, 152
PARTSCH cincel99	pinza FRAENKEL342	pinza MARSCHIK282
	pinza GELFOAM-HOUSE85	pinza MASTIN318
	pinza GILLIES 151	pinza McINDOE..... 151
	pinza GRAEFE95, 151	pinza micro 131, 350-351

pinza MIDDLETON-JANSEN	159	placa para el paladar	277	R	
pinza MIKULICZ	283	placa para extender la piel	220	RAGNELL (KILNER) tijera.....	191
pinza nasal	149-161, 164-186	PLESTER cuchillo	122	REDA bisturi	217
pinza naso-faringea JATHO	310	PLESTER gancho	137	REDA especulo nasal	144
pinza naso-faringea		PLESTER separador	113, 264	REDA gancho	249
ST.CLAIR-THOMSON	310	PLESTER tubo de aspiracion	126	REDA porta-algodon	64
pinza NEGUS	281	polipotomo	72, 162-163	REICHERT depresor	343
pinza NOYES	155	polipotomo KRAUSE	72, 162	REINER jeringa	61
pinza optica	15	polipotomo KRAUSE-VOSS	162	REINKE-LOPEZ disector.....	290
pinza para amigdalas	281-283	polipotomo VOSS-KRAUSE	162	retractor AUFRICHT	251
pinza para antro.....	184-185	polipotomo WILDE.....	72, 163	retractor COTTLE	251
pinza para biopsia	167, 179	POLITZER aguja	70-71	retractor MASING-NEIVERT	251
pinza para bronco-esofagoscopia		POLITZER cuchillo	71	retractor nasal.....	251
CHEVALIER-JACKSON	356	POLITZER especulo auricular.....	53	retractor NEIVERT-MASING	251
pinza para bronco-esofagoscopia		POLITZER insuflador de aire	61	REYNOLDS (JAMESON) tijera	191
JACKSON-CHEVALIER	356	porta aguja.....	123-124, 209, 349	RI-MINI estuche diagnostico	52
pinza porta-esponja.....	295	porta aguja BABY-WEBSTER	209	RITTER-HALLE sonda	261
pinza relojero	96	porta aguja BARRAQUER.....	123	ROEDER "E" cierranudo	303
pinza RUBIN	161	porta aguja CASTROVIEJO	124	ROGER elevador.....	222
pinza sacabocado.....	109	porta aguja CRILE-WOOD	209	ROLLET gancho.....	250
pinza sacabocado CITELLI	109	porta aguja DERF	209	ROSEN / BARBARA aguja... 135, 136	
pinza sacabocado		porta aguja HALSEY	209	ROSEN cuchillo.....	120
KERRISON.....	109, 182	porta aguja WEBSTER.....	209	ROSEN periostotomo	93
pinza SAWTELL	281	porta aguja WEBSTER-BABY	209	ROSEN tubo de aspiracion	129
pinza SCHMEDEN	169	porta aguja WOOD-CRILE	209	ROSER-KOENIG abre-boca	271
pinza SCHNIDT	281	porta-algodon	63-64	ROUX BABY separador	263
pinza SEMKEN.....	95	porta-algodon	347	RUBIN osteotomo.....	234
pinza SINUS (LISTER).....	155	porta-algodon FARRELL	63	RUBIN pinza.....	161
pinza		porta-algodon FEIN	347	RUSSEL-DAVIS baja-lengua.....	278
SMITH-FERRIS-KERRISON	181	porta-algodon FROHN.....	63	RYDEL-SEIFFERT diapason.....	59
pinza STANDARD	95	porta-algodon JOBSON-HORNE	64		
pinza STRUEMPEL.....	75	porta-algodon KILLIAN	347	S	
pinza STRUYCKEN.....	169	porta-algodon REDA.....	64	SANVENERO tijera	190
pinza TAKAHASHI.....	165	porta-algodon UCKERMANN	64	SAWTELL pinza	281
pinza THILENIUS	283	portador de luz.....	334, 337-341	SCHEINMANN punta	354
pinza TILLEY	74, 155	PRINCE tijera	296	SCHINK dermatomo.....	220
pinza TROELTSCH	149	punta BARACANI	354	SCHMEDEN pinza	169
pinza TROELTSCH (WILDE)..	94, 152	punta BRUENINGS	354	SCHMIDT-MORITZ baja-lengua...269	
pinza TYDING	282	punta CORDES	354	SCHNIDT pinza	281
pinza WALSHAM	160	punta FRAENKEL.....	354	SCHOENBORN separador.....	317
pinza WATSON-WILLIAMS	166	punta KRAUSE.....	354	SCHUKNECHT cuchillo.....	122
pinza WEIL-BLAKESLEY	164, 168	punta LANGE	354	SCHUKNECHT	
pinza		punta SCHEINMANN	354	dispositivo para modelar.....	85
WEINGÄRTNER-HARTMANN	75	punta SCHUMACHER.....	354	SCHUKNECHT tijera	81
pinza WESTMACOTT	154	punta SEIFERT	354	SCHUMACHER punta.....	354
pinza WHITE	281			SEBILEAU elevador	86
pinza WILDE (TROELTSCH)..	94, 152	Q		SEIFERT punta	354
pinza WILLIAMS-WATSON	166	QUERVAIN elevador	86	SEMKEN pinza.....	95
pinza WULLSTEIN	79	QUIRE elevador	73	separador	110-114, 148, 263-265,
pinza		QUISLING martillo.....	260268, 270, 288-289, 314, 317	
WULLSTEIN-HARTMANN	75, 175			separador ADSON.....	112
pinza YOUNG.....	270			separador ALM	110

separador BABY ROUX	263	SLUDER-BALLENGER		tijera COTTLE	194, 198
separador BOSE	314	amigdalotomo	305	tijera COTTLE-MASING	198
separador BRÜNINGS-BRUNK.....	263	SMITH-FERRIS-KERRISON		tijera DEAN.....	296
separador BRUNK-BRÜNINGS.....	263	pinza	181	tijera FISCH	82
separador		sonda63, 132, 261-262, 293, 317		tijera FOMON	198
CAWOOD-MINNESOTA.....	268	sonda auricular STACKE.....	63	tijera FREEMAN-GORNEY	200
separador FINSSEN	110	sonda BOWMAN	262, 293	tijera GOOD	296
separador FISCH.....	112, 265	sonda FRONTAL	261	tijera GORNEY	116, 200
separador HOFER.....	289	sonda HALLE-RITTER	261	tijera GORNEY-FREEMAN.....	200
separador HOLZHEIMER.....	110	sonda HOUSE	132	tijera GRADLE	195
separador JANSEN	110	sonda KOCHER	317	tijera GRAEFE	194
separador		sonda RITTER-HALLE	261	tijera GREENBERG-PAR	202
KOCHER-LANGENBECK	263	sonda SINUS.....	261	tijera GREVEN.....	81
separador		soporte	57, 280, 335-336	tijera HEYMAN	198
LANGENBECK-KOCHER	263	soporte de pecho NEGUS.....	280	tijera IRIS.....	117, 192
separador LEYLA	148	soporte para espejos		tijera JAMESON (REYNOLDS)....	191
separador LOTHROP	288	auriculares.....	57	tijera JOSEPH	116, 190
separador LOVE	288	soporte para espejos		tijera JOSEPH-PECK	201
separador MIDDELDORPF	263	auriculares YASARGIL	57	tijera KAYE	201-202
separador		soporte pectoral LEWY	336	tijera KELLY	191
MINNESOTA-CAWOOD	268	SPENCER tijera	199	tijera KILLIAN	343
separador MOLLISON	112	SPRATT cucharilla	103	tijera KILNER (RAGNELL)	191
separador NAGER.....	289	St. CLAIR-THOMSON cuchillo.....	309	tijera KNAPP	193
separador PLESTER.....	113, 264	ST.CLAIR-THOMSON		tijera LITTAUER.....	199
separador ROUX BABY	263	pinza naso-faringea	310	tijera LITTLER	194
separador SCHOENBORN.....	317	STACKE sonda auricular.....	63	tijera MASING-COTTLE	198
separador STERNBERG	270	STANDARD pinza	95	tijera McGEE	81
separador WEITLANER	111	STANDARD tijera	117	tijera METZENBAUM	
separador		STERNBERG separador.....	270	115, 188-189, 297
WEITLANER-WULLSTEIN.....	111	STEVENS tijera	196	tijera METZENBAUM FINO ..	115, 189
separador WILLIGER	114	STRABISMUS tijera	116, 196	tijera micro	119, 131, 203-205, 351
separador WULLSTEIN	113	STRUEMPPEL pinza	75	tijera nasal	187-207
separador		STRUYCKEN pinza.....	169	tijera O'BRIEN	199
WULLSTEIN-WEITLANER.....	111			tijera para alambre y	
SET.....	358-372	T		laminas	118, 299
SEWALL elevador	226	TABB cuchillo	122	tijera para amígdalas	296-298
SEXTON cuchillo.....	71	TAKAHASHI pinza.....	165	tijera para el canal de saliva	298
SHAMBAUGH gancho.....	135	tamponador LUNIATSCHEK	292	tijera para tumores.....	207
SHAPLEIGH asa	67	THILENIUS pinza	283	tijera PAR-GREENBERG	202
SHEA cucharilla.....	134	THOMSON-St. CLAIR cuchillo.....	309	tijera PECK-JOSEPH	201
SHEA tijera	80	THUDICHUM espejo nasal	140	tijera PERWITZSCHKY	298
SHEEHAN osteotomo	101, 232	TIECK-HALLE espejo nasal	144	tijera PRINCE	296
SIEGLE espejo auricular	56	tijera	80-83, 115-119, 187-207,	tijera RAGNELL (KILNER).....	191
sierra nasal	244-245	296-299, 343	tijera REYNOLDS (JAMESON)....	191
sierra nasal JOSEPH.....	244-245	tijera auricular	80-83	tijera SANVENERO	190
sierra nasal LINDEMANN.....	245	tijera BELLUCCI	80	tijera SCHUKNECHT	81
SILVER cincel.....	233	tijera BEUSE.....	201	tijera SHEA	80
SILVER dermatomo.....	221	tijera BOETTCHER.....	296	tijera SPENCER	199
SINUS (LISTER) pinza	155	tijera BONN	192	tijera STANDARD	117
SINUS elevador.....	223	tijera CAPLAN	206	tijera STEVENS	196
SINUS sonda	261	tijera CONVERSE/WILMER/		tijera STRABISMUS	116, 196
sinuscopio.....	15	WALTER.....	194	tijera UNIVERSAL	118, 299

tijera WAGNER	197	U	WULLSTEIN periostotomo	92
tijera WALTER/CONVERSE/ WILMER	194	UCKERMANN porta-algodon	WULLSTEIN pinza	79
tijera WILMER/CONVERSE/ WALTER	194	UNI I otoscopio	WULLSTEIN separador	113
tijera WULLSTEIN	83	UNI II oftalmoscopio	WULLSTEIN tijera	83
TILLEY pinza	74, 155	UNI III estuche diagnostico	WULLSTEIN-HARTMANN pinza	75, 175
TOBOLD baja-lengua	270	UNIVERSAL lanzapolvo	WULLSTEIN-WEITLANER separador	111
TOYNBEE especulo auricular	53	UNIVERSAL tijera		
transformador	26	V	Y	
trocar COAKLEY	215	VOLKMANN cucharilla	YANKAUER elevador	290
trocar LICHTWITZ	215	VOLTOLINI especulo nasal	YANKAUER tubo de succion	284
trocar para sinoscopia	215	VOSS-KRAUSE polipotomo	YANKAUER-BABY tubo de succion	284
TROELTSCH (WILDE) pinza	94, 152	W	YASARGIL soporte para especulos auriculares	57
TROELTSCH pinza	149	WAGENER gancho	YOUNG pinza	270
TROUSSEAU dilatador	314	WAGENER-MOSHER canula		
TROUSSEAU-BABY dilatador	314	WAGNER tijera	Z	
tubo de aspiracion 125-129, 284, 348		WALSHAM pinza	ZAUFAL elevador	65
tubo de aspiracion BARON	128	WALTER cincel	ZAUFAL-JANSEN elevador	65
tubo de aspiracion EICKEN (KILLIAN)	212	WALTER/CONVERSE/ WALTER tijera	ZAUFAL-JANSEN pinza gubia	107
tubo de aspiracion	212	WATSON dermatomo	ZIEGLER espejo frontal	23
FERGUSON	213	WATSON-WILLIAMS pinza	ZÖLLNER tubo de aspiracion	125
tubo de aspiracion	213	WEBER-LOCH asa		
FERGUSON / FRAZIER	125, 213	WEBSTER porta aguja		
tubo de aspiracion	125, 213	WEBSTER-BABY porta aguja		
FRAZIER / FERGUSON	125, 213	WEIL-BLAKESLEY pinza		
tubo de aspiracion HOUSE	126, 214	WEINGÄRTNER-HARTMANN pinza		
tubo de aspiracion KILLIAN	212	WEISS-DUPUY aguja		
tubo de aspiracion KILLIAN (EICKEN)	212	WEITLANER separador		
tubo de aspiracion PLESTER	126	WEITLANER-WULLSTEIN separador		
tubo de aspiracion ROSEN	129	WEST cincel		
tubo de aspiracion ZÖLLNER	125	WESTMACOTT pinza		
tubo de extension BRUENINGS	354	WHITE pinza		
tubo de silicona	277	WIEDER baja-lengua		
tubo de succion		WIEN Mod. especulo nasal		
BABY-YANKAUER	284	WIENER escofina		
tubo de succion y coagulacion	211, 348	WILDE (TROELTSCH) pinza		
tubo de succion YANKAUER	284	WILDE polipotomo		
tubo de succion		WILDER dilatador		
YANKAUER-BABY	284	WILLIAMS-WATSON pinza		
TYDING cierranudo	300	WILLIGER cucharilla		
TYDING pinza	282	WILLIGER periostotomo		
		WILLIGER separador		
		WILMER/CONVERSE/ WALTER tijera		
		WOOD-CRILE porta aguja		
		WULLSTEIN cuchillo		
		WULLSTEIN mango de succion		

Hauptkatalog Chirurgische Instrumente
General catalog surgical instruments

Arthroskopie
Arthroscopy

Container Steriltechnik
Container Sterilization Technique

Endoskopie
Endoscopy

HERCULES® Drahtkneifzange
HERCULES® Wire Cutters

Plastische Chirurgie
Plastic surgery

Orthopädie
Orthopedic

Titan Instrumente
Titanium Instruments

Neurochirurgie
Neurosurgery



Maltepe Mah.Eski Çırpıcıyolu Sk.
Merter Merkezi D Blok 2/21
034234- Zeytinburnu, stanbul

+90 212 482 71 52
info@redamed.com
