



Zahnärztliche Instrumente

Dental Instruments

Instrumental dental

Strumenti dentali

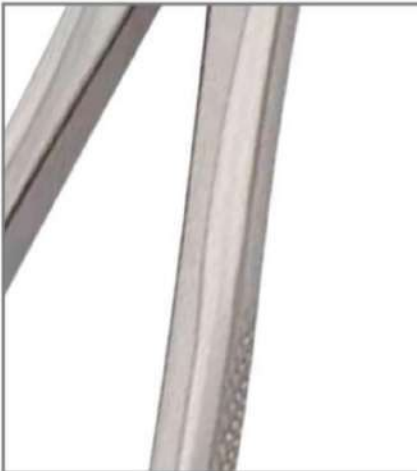

+Redamed



Maltepe Mah.Eski ırpıcıyolu Sk.
Merter İş Merkezi D Blok 2/21
034234- Zeytinburnu, İstanbul

+90 212 482 71 52
info@redamed.com

Charrière (Ch) French (F)	Durchmesser in mm	Inches
1	0,33	0,013
2	0,67	0,025
3	1,00	0,039
4	1,33	0,051
5	1,67	0,065
6	2,00	0,0787
7	2,33	0,092
8	2,67	0,105
9	3,00	0,1181
10	3,33	0,131
11	3,67	0,144
12	4,00	0,1575
13	4,33	0,170
14	4,67	0,184
15	5,00	0,1968
16	5,33	0,210
17	5,67	0,223
18	6,00	0,2362
19	6,33	0,249
20	6,67	0,263
21	7,00	0,2756
22	7,33	0,288
23	7,67	0,302
24	8,00	0,3150
25	8,33	0,328
26	8,67	0,341
27	9,00	0,3543
28	9,33	0,367
29	9,67	0,380
30	10,00	0,3973
31	10,33	0,407
32	10,67	0,420
34	11,33	0,446
36	12,00	0,4724
38	12,67	0,494
40	13,33	0,5199
45	15,00	0,5905

Gauge (G)	Durchmesser in mm	Inches
35	0,13	0,005
34	0,18	0,007
33	0,20	0,008
32	0,23	0,009
31	0,25	0,010
30	0,30	0,012
29	0,33	0,013
28	0,36	0,014
27	0,41	0,016
26	0,46	0,018
25	0,51	0,020
	0,53	0,021
24	0,56	0,022
23	0,64	0,025
22	0,71	0,028
21	0,81	0,032
20	0,89	0,035
	0,97	0,038
19	1,07	0,042
18	1,27	0,050
17	1,50	0,059
16	1,65	0,065
15	1,83	0,072
14	2,11	0,083
13	2,41	0,095
12	2,77	0,109
11	3,05	0,120
10	3,40	0,134
9	3,76	0,148
8	4,19	0,165
7	4,57	0,180
6	5,16	0,203

1 OZ	0,028 ml
5 OZ	0,140 ml
16 OZ	0,450 ml

35 OZ	1,0 l
128 OZ	3,7 l

GARANTIE / WARRANTY / GARANTIA / GARANZIA

GARANTIE

Wir gewähren auf alle **Reda**-Instrumente 5 Jahre Garantie. Voraussetzung ist der sach- und fachgerechte Einsatz der Instrumente.

Von der Garantie sind Verschleißerscheinungen ausgeschlossen.

WARRANTY

Our **Reda** products are free from manufacturing defects in material and workmanship. We therefore give on all instruments a guarantee of five years provided that the instruments are maintained and cleaned properly and used normally for their intended purpose.

GARANTIA

Estamos convencidos de nuestra calidad y concedemos a todos los instrumentos de **Reda** 5 años de garantía contra cualquier defecto de fabricación, siempre y cuando se usen adecuadamente. De la garantía excluimos la manifestación de desgaste.

GARANZIA

Siamo convinti della nostra qualità e concediamo cinque anni di garanzia sulla funzione dei tutti gli strumenti **Reda** sotto la presupposizione che l'utilizzo è da esperto.

Escluso della garanzia sono tracce di consumo.

Indikationen und Kontraindikationen finden Sie in der entsprechenden Gebrauchsanweisung!

Indication and Contraindication please refer to our user`s manual!

Indicaciones y Contraindicaciones se encuentran en la instrucciones de uso correspondientes!

Indicazioni e controindicazioni sono segnalti nel foglio istruzioni d'impiego.

Arbeitsanweisung **Aufbereitung (Reinigung) und Sterilisation von resterilisierbaren** **chirurgischen Instrumenten**

DIN EN ISO 17664:2004 (D)

Hersteller:
REDA Instrumente GmbH, Gänsäcker 34
78532 Tuttlingen

Alle von Reda gelieferten wieder verwendbaren Instrumente wurden ausschließlich für den chirurgischen Gebrauch konstruiert und dürfen zu keinen anderen Zwecken benutzt werden. Unsachgemäße Handhabung und sorglose Pflege sowie zweckentfremdeter Gebrauch können zu vorzeitigem Verschleiß der Instrumente führen. Die Produkte sind bei der Auslieferung nicht sterilisiert.

Reinigungsvorbereitung

Fabrikneue Instrumente müssen vor der ersten Anwendung den gesamten Aufbereitungsprozess durchlaufen. Instrumente unmittelbar nach Anlieferung aus den Folienverpackungen entnehmen und in trockenen Räumen bei gleichbleibender Raumtemperatur luftoffen lagern, um Kondensationsbildung zu vermeiden.

Die Instrumente keinen Sonnenlichteinstrahlungen oder Dämpfen durch Chemikalien (Säuren oder scharfe Reinigern) aussetzen. Vor der ersten Sterilisation alle Schutzkappen und Folien vollständig entfernen und anschließend reinigen.

Gebrauchte Instrumente unmittelbar nach Beendigung des Eingriffs von Blut, Gewebe und Arzneimittel reinigen. Instrumente in eine freigegebene Lösung eines kombinierten Reinigungs- und Desinfektionsmittels, das keine proteinfixierende Wirkung besitzt, einlegen.

Dosierung des Herstellers beachten. Nicht in NaCl Lösung einlegen, ansonsten Gefahr für Loch- bzw. Spannungsriss-Korrosion

Überfüllung von Instrumentensieben und Wasch-Trays vermeiden.

Gelenkinstrumente vor dem Aufbereiten öffnen. Zerlegbare Instrumente gemäß Bedienungsanleitung (Piktogramm) zur Reinigung zerlegen. Reinigungsgerechtes Zubehör verwenden. Für die manuelle Reinigung nie Metallbürsten oder Metallschwämme verwenden.

Spülmaschinen und Ultraschallanlagen nicht überladen. Spül- oder Schallschatten vermeiden. Dosierung, Einwirkzeit und Einwirktemperatur bei der Desinfektion und Reinigung unbedingt einhalten. Nach der Reinigung sorgfältig spülen. Möglichst vollentsalztes (demineralisiertes) Wasser verwenden.

Nach dem Spülen ausreichend trocknen. Abgenutzte, korrodierte, deformierte, poröse oder anderweitig beschädigte Instrumente aussortieren.

Aus hygienischen Gründen müssen Instrumente, die zur Reparatur eingesandt werden komplett aufbereitet werden.

Gelenkinstrumente nach jeder Aufbereitung mit einem Pflegemittel auf Basis von Paraffinöl behandeln (gilt nicht für flexible Endoskope und Zubehör).

Funktionsprüfung in zusammengebautem Zustand durchführen.

Instrumente mit Rastensperre vor der Sterilisation nur im ersten Zahn schließen.

Als Sterilisationsverfahren empfehlen wir die Dampfsterilisation (üblicherweise mit Sattedampf bei 134° C)

Sterilisation ist kein Ersatz für Sauberkeit!

Die Broschüre "Instrumenten-Aufbereitung richtig gemacht" des Arbeitskreis Instrumenten-Aufbereitung dient als Anhalt.

Reda Instrumente GmbH
78532 Tuttlingen

IMPORTANT INFORMATION CONCERNING PREPARING AND STERILIZING SURGICAL INSTRUMENTS

Dear Sirs,
please read the following instructions very carefully before using the instruments.

1. INITIAL USE

All instruments which are being used for the first time must be thoroughly cleaned, rinsed and then sterilized before using.

2. TREATING INSTRUMENTS AFTER USAGE

- a.) The instruments might be immediately thoroughly cleaned and disinfected. Please follow the manufacturer's instructions when using cleaning agents and disinfectants.
- b.) Instruments which may be dismantled must be cleaned and disinfected after being taken apart.
- c.) Cleaning may be carried out either manually or with a machine. Care should be taken that only cleaning agents and disinfectants are used, which are changed daily.
- d.) Following chemical disinfection and manual cleaning, all instruments must always be thoroughly rinsed under running water.
- e.) The temperature of water used in a machine for cleaning should not exceed 45°C.
- f.) Whether cleaning is carried out manually or by machine, we especially ask you to ensure that the correct dosage for cleaning solutions or the correct combination of disinfectant and cleaning solution, is employed. Similar importance should be applied to the length of time the agents require to perform properly and to the temperature set.
- g.) Hinged instruments should be opened before cleaning.
- h.) Please ensure that the perforated instrument trays, when loaded, do not exceed 10 kg in weight.
- i.) Please take care that when instruments are being cleaned they are arranged proper in a manne that fluids can circulate freely.
- j.) Deposits remaining after the cleaning process must be completely removed in the first rinse which now follows. The optimum temperature for final rinsing has proved to be between 70° and 90° C. Please use only purified water in this final cleaning stage.
- k.) The instruments must be carefully dried after cleaning and rinsing is completed.
- l.) Moving parts and the cutting edges of shears and scissors must be treated with preservatives which are both suitable and physiologically safe.

3. TESTING FOR CORRECT FUNCTIONING

- a.) Instruments must be carefully and thoroughly checked before every occasion that they are used.

- b.) After each time they are cleaned, the instruments must be macroscopically clean, i.e., visibly free from proteinbased residues and other soiling.
- c.) Care should be taken so that cracks, breakages and corrosion are noticed.
- d.) Instruments with flecks should be separated and taken out for special treatment.
- e.) All moving parts as well as working tips and blades should be checked with special care.
- f.) Checking should be carried out according to the extent to which the instruments will be used.
- g.) Instruments which are in any way defective or damaged should be immediately sorted out from the others.

4. STERILIZATION

- a.) All stainless steel surgical instruments supplied by us may be sterilized in an autoclave.
- b.) Please follow the manufacturer's operating instructions when using autoclave. All machines used must comply with all current quality and other standards.
- c.) Instruments are being sterilized/ autoclaved at a temperature of 134°C.
- d.) Sterilization packing material must comply with all current standards.
- e.) Instruments with ratchets or self-retaining mechanisms should be sterilized opened or in the first ratchet position.
- f.) Please ensure that perforated instrument trays, when loaded do not exceed 10 kg in weight.

5. IN GENERAL

- a.) All surgical instruments supplied by us have been thoroughly inspected before dispatch and leave our factory in perfect condition. Damage which can arise as a result of transporting, cleaning, preserving, sterilizing or storing, must be prevented.
- b.) Please handle surgical instruments always with the utmost care.
- c.) Instruments must be stored in a clean and dry place.
- d.) If you have any queries or problems please contact us at any time:

We should like to point out that, if the above-mentioned directions are not followed or the instruments supplied by us are not properly used, all guarantee claims become void and any consequences must be borne by yourselves.

SUGERENCIAS PARA LA LIMPIEZA, ESTERILIZACIÓN Y MANTENIMIENTO DE INSTRUMENTOS QUIRÚRGICOS

ENJUAGADO

Tras el uso enjuagar enseguida los instrumentos bajo un chorro de agua caliente (no hirviendo). El enjuagado debe servir para quitar los residuos de sangre, mucosas y tejidos.

LIMPIEZA

Si la limpieza no se efectúa inmediatamente después del enjuagado, los instrumentos tienen que sumergirse en una solución de agua y detergente con PH neutro (7)

Para los instrumentos muy delicados (algunos tipos de porta agujas o tijeras se aconseja una limpieza manual: ver punto "C").

a.- Limpieza en la pila de ultrasonido

Los instrumentos tienen que estar en la pila el tiempo necesario recomendado por el fabricante para efectuar el ciclo del lavado, generalmente de 5 a 10 minutos.

Los instrumentos con bisagras o juntas (articulaciones) tienen que sumergirse en la pileta en posición abierta.

Asegurarse de que las hojas afiladas de las tijeras, bisturís para gingivectomía, curetas, etc. no estén en contacto con otros instrumentos.

Todos los instrumentos deben estar completamente sumergidos en la solución de lavado.

No poner instrumentos de diferentes metales (acero inoxidable, instrumentos cromados, latón, etc.) en el mismo ciclo de lavado.

Cambiar a menudo la solución para el lavado, como mínimo todas las veces que lo recomienda el fabricante de la pila de ultrasonidos.

Enjuagar concienzudamente los instrumentos con agua corriente tras lavado con ultrasonidos para quitar los residuos de la solución de lavado.

b.- Limpieza con lavadora

Seguir las indicaciones del fabricante. Asegurarse de que los instrumentos hayan sido lubricados tras el último ciclo de lavado y antes del ciclo de esterilización.

c.- Limpieza manual

La mayor parte de los fabricantes de instrumentos indican el lavado con los ultrasonidos como el modo mejor y más eficaz para limpiar los instrumentos quirúrgicos, especialmente los que tienen bisagras, cierres y en general articulaciones. Si la limpieza con los ultrasonidos no es posible, se aconseja usar el método siguiente:

- Usar cepillos rígidos de plástico, nylon, etc.
- Cepillar concienzudamente los instrumentos más delicados y, si es posible, enjuagar, limpiar y esterilizar estos instrumentos separadamente.
- Verificar que toda la superficie de estos instrumentos esté limpia.
- Tras haber cepillado los instrumentos, enjuagarlos bajo el chorro de agua corriente.
- Durante el enjuagado abrir y cerrar las tijeras, las pinzas hemostáticas, los porta agujas y los demás instrumentos con bisagras o juntas y asegurarse de que las partes internas de las bisagras estén perfectamente enjuagadas como la superficie externa del instrumento.

SECADO, LUBRIFICACIÓN E INSPECCIÓN

Tras las operaciones de limpieza y de enjuagado, los instrumentos quirúrgicos tienen que ser secados perfectamente.

Todos los instrumentos con juntas o bisagras (acción "metal contra metal") como tijeras, pinzas hemostáticas, porta agujas, fórceps de extracción, etc., tienen que ser lubricados. Se aconsejan lubricantes específicos para el instrumental quirúrgico. No usar aceites o lubricantes industriales.

A este punto es buena norma inspeccionar el estado de cada instrumento y verificar el funcionamiento según el uso específico. Controlar y asegurarse de que:

- Las hojas de las tijeras estén lisas de arriba abajo y de que, una vez cerradas, no hagan juego. Probar las tijeras cortando gasa muy fina. Tres cuartas parte de la hoja tienen que cortar la gasa sin retenerla.

- Las puntas de las pinzas estén al mismo nivel.
- Las pinzas hemostáticas y los porta agujas no dejen pasar la luz entre las puntas cuando estén cerradas, se abran y cierren fácilmente y que las bisagras no estén demasiado flojas.
- Controlar el desgaste de la porta agujas sobre la superficie interna de las puntas.
- Las cánulas metálicas de aspiración estén bien limpias en su interior.
- Los instrumentos cortantes y los bisturís tengan las hojas bien afiladas y no estropeadas.

ESTERILIZACIÓN EN AUTOCLAVE

Tras haber enjuagado, limpiado, secado, lubricado e inspeccionado los instrumentos, éstos pueden ser preparados para la esterilización separadamente o en serie.

Instrumentos individuales:

Las bolsas especiales monouso son el ideal para contener los instrumentos. Asegurarse de que las bolsas que contendrán los instrumentos con cierres y articulaciones (pinzas hemostáticas, porta agujas, etc.) sean lo bastante grandes como para contener los citados instrumentos en posición abierta.

Instrumentos en serie:

Poner los instrumentos en los especiales cestos o bandejas de acero inoxidable. Poner los instrumentos más pesados en la parte inferior cuando sean necesarias varias bandejas.

No cerrar nunca los instrumentos durante el ciclo en autoclave. Un instrumento cerrado no estará nunca bien esterilizado, ya que el vapor no puede penetrar en la parte de cierre a contacto "metal contra metal". En el instrumento podría además romperse en la parte de la bisagra a causa de la expansión del metal debida al calor durante el ciclo del autoclave.

No cargar demasiado la cámara del autoclave ya que algunos instrumentos podrían formar "zonas de sombra" sobre otros en los que el vapor no penetraría.

ATENCIÓN

Al final del ciclo de esterilización - antes del ciclo de secado- abrir ligeramente la portezuela del autoclave y preceder con el ciclo desecado según las instrucciones del fabricante. Si la portezuela del autoclave se abriese completamente antes del ciclo de secado, el aire frío de la habitación entraría en la cámara del autoclave causando la formación de condensación sobre los instrumentos y de consecuencia aparecerían las manchas de agua que vemos a menudo en los mismos.

ESTERILIZACIÓN EN FRÍO:

La mayor parte de las soluciones para la esterilización en frío esterilizan los instrumentos completamente tras 10 horas de inmersión. Esta acción química prolongada puede ser más perjudicial para los instrumentos que el ciclo normal de 20 minutos en autoclave.

Si los instrumentos tienen necesidad de ser simplemente "desinfectados", el proceso en frío es adecuado, ya que la desinfección tiene lugar en 10 minutos solamente.

Recuerde bien la diferencia entre:

ESTÉRIL - término absoluto (ningún organismo logra sobrevivir) y

DESINFECTADO - perfectamente limpio.

Usen siempre la técnica más adecuada de esterilización/limpieza de los instrumentos según el uso que se haga posteriormente de ellos.

Recuerden que la esterilización de los instrumentos no sustituye la limpieza de los mismos.

Recomendamos no volver a usar ni esterilizar los artículos de un solo uso.

Si se tratan en el modo correcto los instrumentos contruidos con las modernas aleaciones inoxidables pueden durar muchos años.

INDICAZIONI PER LA CURA, PULITURA E LA STERILIZZAZIONE DELLO STRUMENTARIO CHIRURGICO RISTERILIZZABILE

Misure preventive anticorrosione

- 1) Raggruppare accuratamente gli strumenti correttamente confezionati e sterilizzati prima dell'operazione; selezionarli secondo l'intervento. Verificare sempre che la confezione esterna sia integra e che lo strumento stesso non sia danneggiato.
- 2) Assicurarli tramite l'indicatore di sterilizzazione collocato all'interno del vaglio che il contenuto sia stato sterilizzato.
- 3) Disporre gli strumenti seguendo l'ordine di utilizzo durante l'operazione; lasciare gli strumenti non necessari nel vaglio; predisporre gli strumenti solo immediatamente prima dell'operazione.
- 4) Nel corso dell'operazione rimuovere dagli strumenti sangue ed altri materiali biologici; dopo l'uso, riporre gli strumenti nel corretto alloggiamento.
- 5) Risciacquare opportunamente gli strumenti cavi, al fine di evitare l'adesione di sangue e polvere d'osso.
- 6) Per la pulitura degli strumenti utilizzare una soluzione lattata o una soluzione salina, ma non immergerli nelle suddette soluzioni.
- 7) Iniziare l'operazione di pulitura subito dopo l'intervento. Strumenti utilizzati su pazienti con possibili infezioni: smaltire in modo analogo, eliminando sangue, polvere d'osso parti di tessuto in eccesso.
- 8) Pulire gli strumenti in un luogo previsto nell'ambito della sala operatoria.

Nel caso in cui gli strumenti vadano collocati direttamente nella centrale di sterilizzazione, è necessario dapprima coprirli, per evitare il rischio di contaminazione ai danni del personale o dell'ambiente circostante.

Disinfezione

Durante l'uso di disinfettanti chimici è necessario osservare scrupolosamente le indicazioni del produttore; utilizzare le soluzioni sempre previa diluizione. Nella fase termica di disinfezione con acqua bollente assicurarsi che l'acqua sia priva di corpi estranei.

Pulitura

Indipendentemente dal metodo utilizzato per la pulitura (meccanico o manuale) si raccomanda di verificare attentamente quale detergente vada utilizzato con ciascun metodo. Valori pH consigliati: tra 7,0 e 8,5.

1) Pulitura meccanica

Osservare scrupolosamente le istruzioni d'uso fornite dal produttore della macchina pulitrice. Predisporre gli

strumenti per la pulitura meccanica. Tutti gli strumenti appuntiti e delicati dovrebbero essere puliti manualmente.

Non sovraccaricare i vagli, mettere gli strumenti pesanti sul fondo del vaglio. Se necessario, immergere e risciacquare gli strumenti molto sporchi (strumenti cavi), prima di collocarli nella lavatrice.

2) Pulitura ad ultrasuoni

(fa parte dei metodi di pulitura meccanica)

Prima di inserire uno strumento nel bagno ad ultrasuoni, rimuovere i materiali organici in eccesso. I bagni ad ultrasuoni sono consigliati per le filettatrici o gli strumenti con solchi profondi. L'ultrasuono deve essere seguito da un programma di risciacquo normale.

3) Pulitura manuale

Richiede diverse spazzole in nylon, una canna da soffio ed un ugello da soffio/ un dispositivo ad aria compressa pulito, detergenti e solventi come per la pulitura meccanica.

Per gli additivi di pulitura osservare le indicazioni fornite dal produttore.

Per la pulitura degli strumenti dotati di cannula, passare più volte lo spazzolino di nylon attraverso la cannula eseguendo movimenti rotatori (non utilizzare spazzole in lana d'acciaio/metallo) fino alla completa rimozione dei residui eliminabili con questo metodo.

Soffiare poi con aria compressa nella cannula.

4) Asciugatura

Ogni strumento deve essere asciugato completamente sia internamente che esternamente per evitare la formazione di ruggine o malfunzionamenti.

Indicazioni per la sterilizzazione della strumentazione

Pulire immediatamente ed asciugare bene gli strumenti usati, non utilizzare detergenti e disinfettanti con additivi fortemente acidi o alcalini (ad es. soda, soda caustica o acidi)!

Sterilizzare la strumentazione solo a vapore A 134°!

Prima della sterilizzazione, assicurarsi che gli strumenti siano perfettamente funzionanti ed integri. La sterilizzazione non sostituisce la pulitura.

Maßstäbe, Schieblehren
 Rulers, Calipers
 Reglas, Calibres
 Misuratori, Calibri

mm / inch



Metall

03340-15 15 cm 6"
 03340-20 20 cm 8"

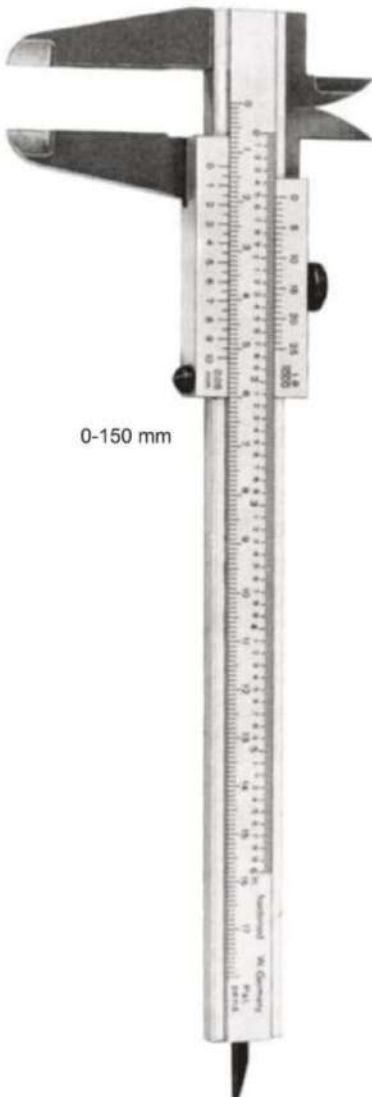

0-150 mm

03360-21
 21 cm, 8 1/4"



0-100 mm

TOWNLEY
 03361-10
 11,5 cm, 4 1/2"



0-100 mm

BOLEY
 03362-10
 14 cm, 5 1/2"

Schieblehren
Calipers
Calibres
Calibri



0-15 mm

CASTROVIEJO
43583-06
7 cm, 2³/₄"



0-20 mm

CASTROVIEJO
43583-07
7 cm, 2³/₄"



0-20 mm

CASTROVIEJO
43583-08
7 cm, 2³/₄"

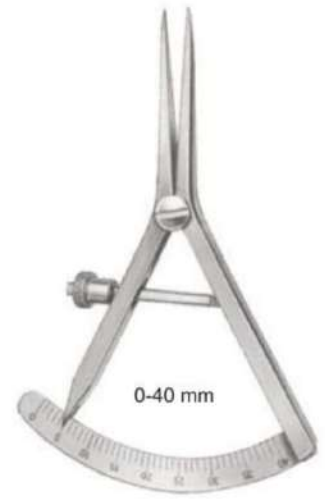

0-40 mm

CASTROVIEJO
43583-09
9 cm, 3¹/₂"



0-40 mm

CASTROVIEJO-EPKER
43583-18
18 cm, 7"



0-40 mm

WEISS-CASTROVIEJO
43584-18
18 cm, 7"

für Metall
for metal
para metal
per metallo

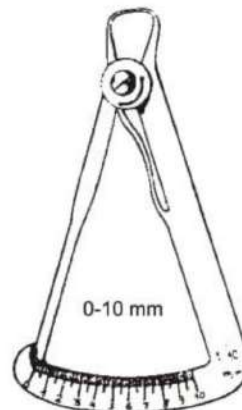

0-10 mm

IWANSON
89270-15

für Wachs
for wax
para cera
per cera



0-10 mm

IWANSON
89271-15

passend zu den Klängen
for blades
para las hojas
per lama bisturi

Skalpelli
Scalpel Handles
Mangos de bisturí
Manici per lama bisturi

(A) No. 10, 11, 12, 13, 14, 15, 16, 17, 18, 19

(B) No. 20, 21, 22, 23, 24, 25



07103-00
Fig. 3

(A)



07104-00
Fig. 4

(B)



07107-00
16,5 cm, 6 1/2"
Fig. 7

(A)



07107-01
12 cm, 4 3/4"
Fig. 7K

(A)



07106-01
14,5 cm, 5 3/4"
Fig. 3

(A)



07106-02
14 cm, 5 1/2"
Fig. 3

(A)

Skalpellgriffe/Skalpellklingen, Zahnfleischmesser
 Scalpel Handles/Blades, Gum knives
 Mangos de bisturí/Hojas, Bisturíes para encías
 Manici per lama bisturi/lame per bisturi, Coltelli per gengive

Packung mit 10 Stück
 box of 10
 en cajas de 10 unidades
 confezione di 10 pezzi



Skalpelli-Klingen, Steril
 Scalpel Blades, Sterile
 Hojas de bisturí, estéril
 Lame per bisturi, sterili



07110-00



07111-00



07112-00



07113-00



07115-00



07116-00



07118-00



07119-00



07120-00



07121-00

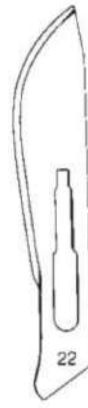

07122-00



07123-00



07124-00

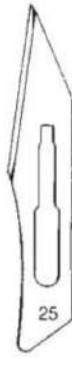

07125-00



Packung mit 100 Stück
 in packages of 100 each
 en cajas de 100 c/u
 confezione di 100 pezzi

Skalpelli-Klingen-Entferner
 Scalpel Blade Remover
 Quita hojas
 Toglilama



07130-00

Chirurgische Scheren
 Operating Scissors
 Tijeras para cirugía
 Forbici per chirurgia

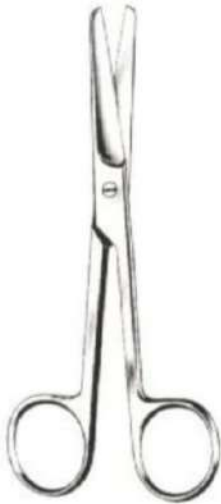

STANDARD

- 09102-14 14,5 cm, 5³/₄"
- 09104-14 TC**
- 09102-15 15,5 cm, 6"
- 09102-16 16,5 cm, 6¹/₂"
- 09102-18 18,5 cm, 7¹/₄"



STANDARD

- 09110-14 14,5 cm, 5³/₄"
- 09114-14 TC**
- 09110-15 15,5 cm, 6"
- 09110-16 16,5 cm, 6¹/₂"
- 09110-18 18,5 cm, 7¹/₄"



STANDARD

- 09120-14 14,5 cm, 5³/₄"
- 09124-14 TC**
- 09120-15 15,5 cm, 6"
- 09120-16 16,5 cm, 6¹/₂"
- 09120-18 18,5 cm, 7¹/₄"



STANDARD

- 09103-14 14,5 cm, 5³/₄"
- 09105-14 TC**
- 09103-15 15,5 cm, 6"
- 09103-16 16,5 cm, 6¹/₂"
- 09103-18 18,5 cm, 7¹/₄"



STANDARD

- 09111-14 14,5 cm, 5³/₄"
- 09115-14 TC**
- 09111-15 15,5 cm, 6"
- 09111-16 16,5 cm, 6¹/₂"
- 09111-18 18,5 cm, 7¹/₄"



STANDARD

- 09121-14 14,5 cm, 5³/₄"
- 09125-14 TC**
- 09121-15 15,5 cm, 6"
- 09121-16 16,5 cm, 6¹/₂"
- 09121-18 18,5 cm, 7¹/₄"

Präparierscheren
Dissecting Scissors
Tijeras de disección
Forbici per dissezione



METZENBAUM
09280-12 **09284-12 TC**
12 cm, 4 3/4"
09280-15 **09284-15 TC**
15 cm, 6"
09280-18 **09284-18 TC**
18 cm, 7"



METZENBAUM
09281-12 **09285-12 TC**
12 cm, 4 3/4"
09281-15 **09285-15 TC**
15 cm, 6"
09281-18 **09285-18 TC**
18 cm, 7"



METZENBAUM-FINO
09282-15 **09286-15 TC**
15 cm, 6"
09282-18 **09286-18 TC**
18 cm, 7"



METZENBAUM-FINO
09283-15 **09287-15 TC**
15 cm, 6"
09283-18 **09287-18 TC**
18 cm, 7"

Präparierscheren
Dissecting Scissors
Tijeras de disección
Forbici per dissezione



— LEXER —
09190-16 09191-16
16 cm, 6 1/4"

09194-16 TC 09195-16 TC



— JOSEPH —
09304-14 09305-14
14 cm, 5 1/2"

09304-14TC 09305-14TC



— KELLY —
09540-16 09541-16
16 cm, 6 1/4"

09542-16 TC 09543-16 TC

Chirurgische Scheren, fein
Operating Scissors, fine
Tijeras para cirugía, finas
Forbici per chirurgia, fine



IRIS



09340-09 9 cm
09340-10 10 cm
09340-11 11 cm
09344-11 TC

gerade
straight
rectas
rette



09341-09
09341-10
09341-11
09345-11 TC

gebogen
curved
curvas
curve

Sehnenscheren
Tendon Scissors
Tijeras para tendones
Forbici per tenotomia



STEVENS
11 cm, 4 3/8"



09360-11 09361-11



09362-11 09363-11

Tonsillenscheren, Präparierscheren
 Tonsil Scissors, Dissecting Scissors
 Tijeras para amígdalas, Tijeras de disección
 Forbici per tonsille, Forbici per dissezione



gezahnt
 saw edge
 dentadas
 dentellata

— DEAN —
 09425-17 09427-17
 17 cm, 6³/₄"



— TOENNIS-ADSON —
 09610-18 09611-18
 18 cm, 7"
09610-18TC **09611-18TC**

Fadenscheren
 Stitch Scissors
 Tijeras para hilos
 Forbici per legature

Drahtschere
 Wire Cutting Scissors
 Tijeras para alambre
 Forbici per filo di metallo



SPENCER
 09802-09
 9 cm, 3¹/₂"



SPENCER
 09802-11
 11 cm, 4³/₈"



NORTHBENT
 09803-09 9 cm, 3¹/₂"
 09803-13 13 cm, 5¹/₈"



LITTAUER
 09804-14
 14 cm, 5¹/₂"



UNIVERSAL
 09831-12 **09835-12 TC**
 12 cm, 4³/₄"

Zahnfleissscheren, feine Scheren
 Gum Scissors, Delicate Scissors
 Tijeras para encias, Tijeras finas
 Forbici per gengiva, Forbici delicate

1 Schneide gezahnt
 1 blade toothed
 1 hoja dentada
 1 taglio della lama dentellato



— GOLDMAN-FOX —
 09820-13 09821-13
 13 cm, 5 1/8"
09820-13TC **09821-13TC**



WAGNER
 12 cm, 4 3/4"

gerade
 straight
 rectas
 rette



Fig. 1
 09828-12



Fig. 2
 09826-12



Fig. 3
 09824-12

gebogen
 curved
 curvas
 curve



Fig. 1
 09823-12



Fig. 2
 09829-12



Fig. 3
 09825-12



LA GRANGE
 09854-11
 11,5 cm, 4 1/2"



gezahnt
 saw edge
 dentadas
 dentellata

LOCKLIN
 09859-16
 16 cm, 6 1/4"



LOCKLIN
09861-16 TC
 16,5 cm, 6 1/2"



gezahnt
 saw edge
 dentadas
 dentellata

LOCKLIN
 09860-16
 16,5 cm, 6 1/2"

Anatomische und chirurgische Pinzetten
 Dressing and Tissue Forceps
 Pinzas de disección sin/con dientes
 Pinze per dissezione, chirurgiche/anatomiche

STANDARD



1 x 2



14,5 cm, 5 ³ / ₄ "	11102-14	11120-14
16,0 cm, 6 ¹ / ₄ "	11102-16	11120-16
18,0 cm, 7"	11102-18	11120-18

schmal
 narrow
 estrecha
 stretta



1 x 2



14,5 cm, 5 ³ / ₄ "	11110-14	11130-14
16,0 cm, 6 ¹ / ₄ "	11110-16	11130-16
18,0 cm, 7"	11110-18	11130-18

1 x 2



SEMKEN

12,5 cm, 5"	11260-12	11270-12
15,5 cm, 6"	11260-15	11270-15
15,5 cm, 6"	11261-15 TC	11271-15 TC

1 x 2



GILLIES

11272-15	15,5 cm, 6"
11273-15 TC	15,5 cm, 6"

1 x 2



11314-01



TAYLOR
 17 cm, 6³/₄"



11314-02

Anatomische und chirurgische Pinzetten
 Dressing and Tissue Forceps
 Pinzas de disección sin/con dientes
 Pinze per dissezione, chirurgiche/anatomiche



ADSON
 11170-12 12,0 cm, 4³/₄"
 11170-15 15,0 cm, 6"



ADSON micro
 11176-12 12,0 cm, 4³/₄"
 11176-15 15,0 cm, 6"



ADSON
 11181-12 TC 12,0 cm, 4³/₄"
 11181-15 TC 15,0 cm, 6"



ADSON
 11180-12 12,0 cm, 4³/₄"
 11180-15 15,0 cm, 6"



ADSON micro
 11186-12 12,0 cm, 4³/₄"
 11186-15 15,0 cm, 6"



ADSON-BROWN
 11188-12 12,0 cm, 4³/₄"
 11189-12 TC 12,0 cm, 4³/₄"

Zahnpinzetten ,Splitterzangen
 Dental Forceps, Splinter Forceps
 Pinzas dentales, Pinzas para espigas
 Pinze dentali, Pinze per schegge

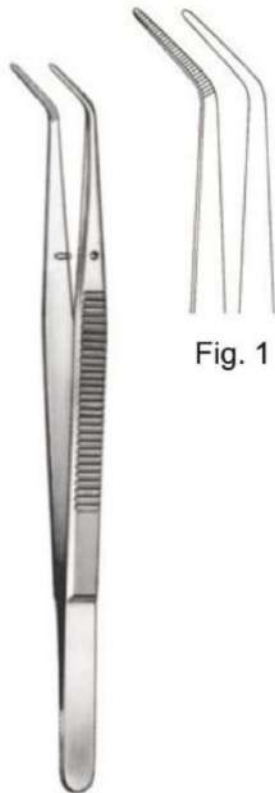

Fig. 1

LONDON-COLLEGE
 11900-01
 15 cm, 6"

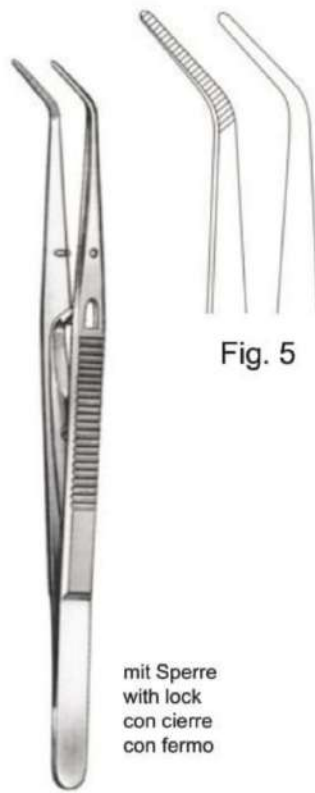

Fig. 5

mit Sperre
 with lock
 con cierre
 con fermo

LONDON-COLLEGE
 11901-05
 15 cm, 6"

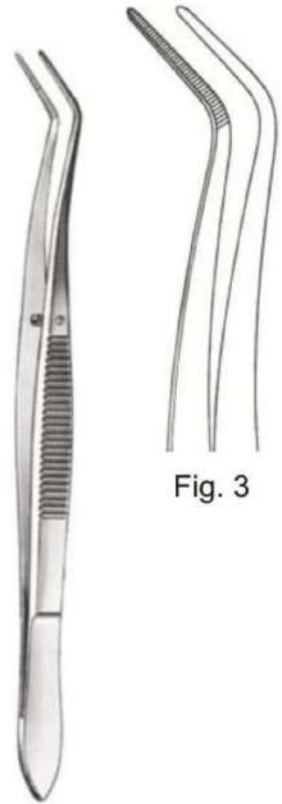

Fig. 3

MERIAM
 11910-01
 15 cm, 6"



PEET
 11821-11
 11,5 cm, 4 1/2"



STIEGLITZ
 11822-13
 11823-13
 13,5 cm, 5 1/4"



VIRTUS (RALK)
 11828-15
 15 cm, 6"

Arterienklemmen
 Hemostatic Forceps
 Pinzas hemostáticas
 Pinze emostatiche



HARTMANN
 13210-10
 10 cm, 4"

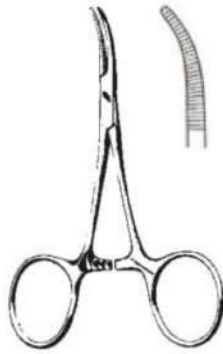

HARTMANN
 13211-10
 10 cm, 4"



HARTMANN
 13212-10
 10 cm, 4"



HARTMANN
 13213-10
 10 cm, 4"



— HALSTED-MOSQUITO —
 13220-12 12,5 cm, 5" 13221-12
 13220-14 14,0 cm, 5 1/2" 13221-14



— HALSTED-MOSQUITO —
 13230-12 12,5 cm, 5" 13231-12
 13230-14 14,0 cm, 5 1/2" 13231-14

Arterienklemmen
Hemostatic Forceps
Pinzas hemostáticas
Pinze emostatiche



ROCHESTER-PEAN

13310-13	13 cm, 5 ¹ / ₈ "	13311-13
13310-14	14 cm, 5 ¹ / ₂ "	13311-14
13310-16	16 cm, 6 ¹ / ₄ "	13311-16

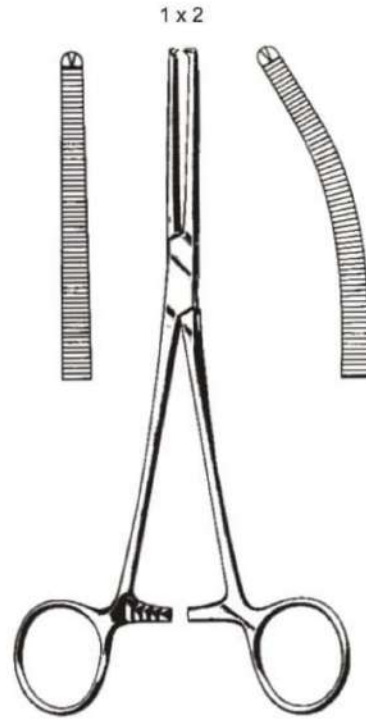

ROCHESTER-OGHSNER

13320-13	13 cm, 5 ¹ / ₈ "	13321-13
13320-14	14 cm, 5 ¹ / ₂ "	13321-14
13320-16	16 cm, 6 ¹ / ₄ "	13321-16



PEAN

13368-14	14 cm, 5 ¹ / ₂ "
13368-16	16 cm, 6 ¹ / ₄ "



LERICHE

13380-15	15 cm, 6"	13381-15
----------	-----------	----------



LERICHE

13382-15	15 cm, 6"	13383-15
----------	-----------	----------

Arterienklemmen, Tuchklemmen
 Hemostatic Forceps, Towel Forceps
 Pinzas hemostáticas, Pinzas de campos
 Pinze emostatiche, Pinze fissateli



ADSON
 13410-18 18,5 cm, 7¹/₄" 13411-18



MIXTER BABY
 13475-18
 18 cm, 7"



SCHAEDEL
 15101-09
 9 cm, 3¹/₂"



JONES
 15103-07 7 cm, 2³/₄"
 15103-09 9 cm, 3¹/₂"



BACKHAUS
 15111-09 9 cm, 3¹/₂"
 15111-11 11 cm, 4³/₈"
 15111-13 13 cm, 5¹/₈"
 15111-15 15 cm, 6"

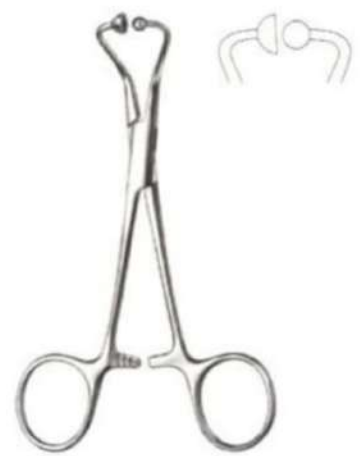

BALL AND SOCKET
 15123-11 11 cm, 4³/₈"
 15123-13 13 cm, 5¹/₈"

Tupfer- und Kornzangen, Schwammzange
 Dressing Forceps, Sponge Forceps
 Pinzas para tampones y curaciones, Pinzas porta-esponjas
 Pinze per tamponi e per medicazione, Pinze per spugne



GROSS-MAIER
 17110-20 20 cm, 8" 17111-20
 17110-25 25 cm, 10" 17111-25



FOERSTER

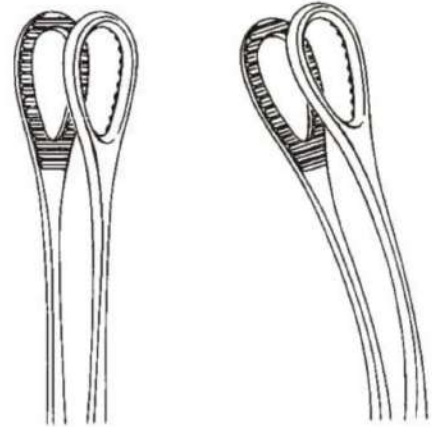

17170-18	18 cm, 7"	17171-18
17170-20	20 cm, 8"	17171-20
17170-25	25 cm, 10"	17171-25

Darm- und Gewebefasszangen
 Intestinal and Tissue Grasping Forceps
 Pinzas para intestinos y tejidos
 Pinze per afferrare intestino e tessuti



ALLIS-BABY
 65102-12
 12 cm, 4³/₄"

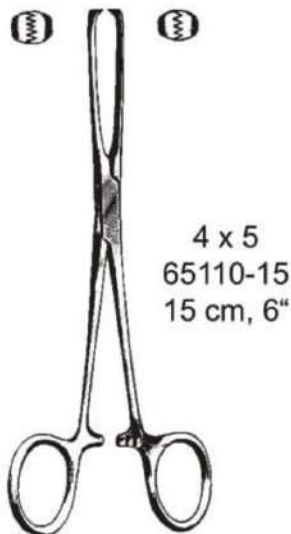

ALLIS
 65120-15 5 x 6
 15 cm, 6"
 65120-19 19 cm, 7¹/₂"



65160-16
 16 cm, 6¹/₄"



Atrauma
 65168-16
 16 cm, 6¹/₄"



BABCOCK

Hauthäkchen
Nerve and wound hooks
Ganchos y ganchitos para nervios
Uncini per nervi e divaricatori fini

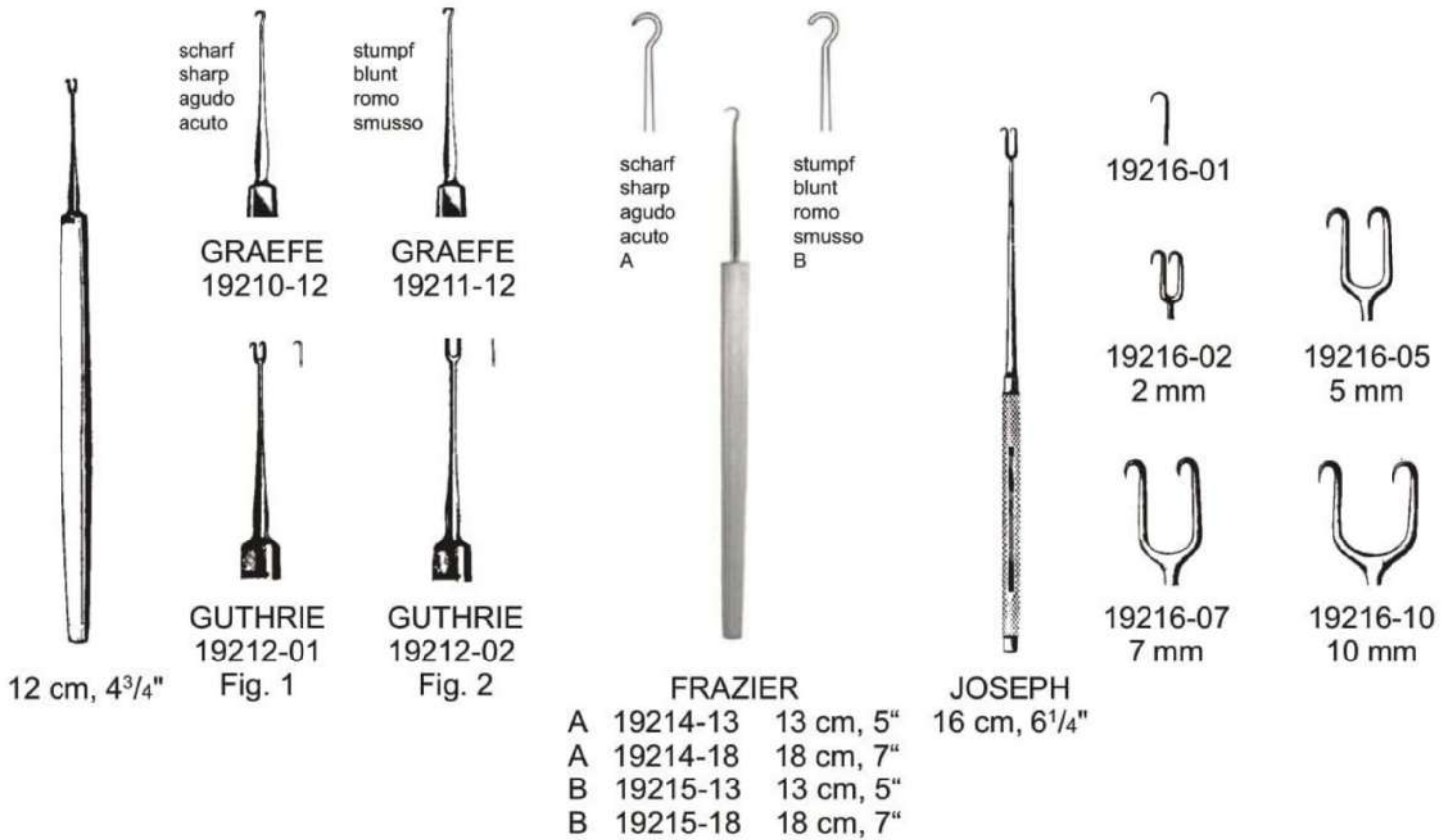

Wundhaken
Retractors
Separadores
Divaricatori

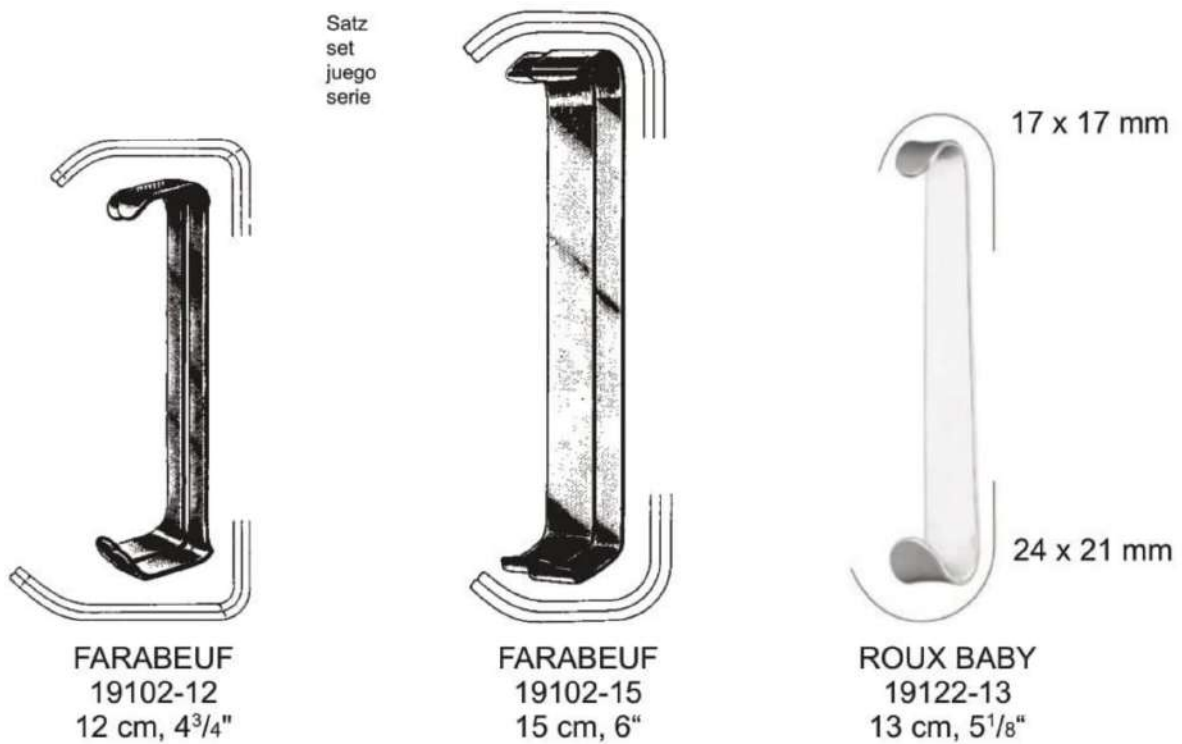
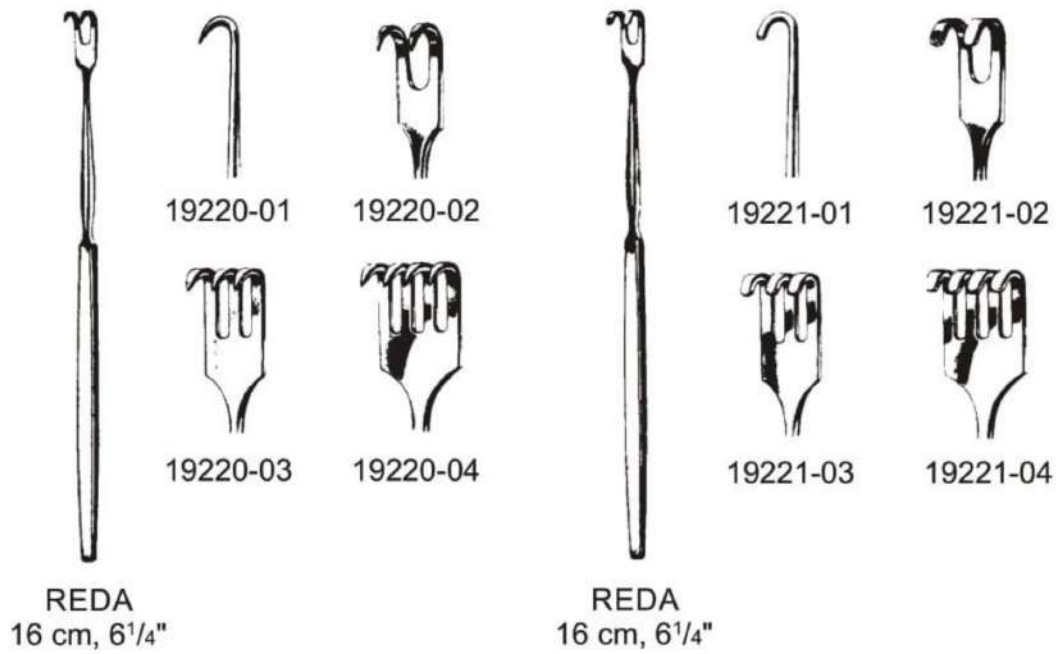

Wundhaken
 Retractors
 Separadores
 Divaricatori

- 19315-06 25 x 6 mm
- 19314-07 35 x 7 mm
- 19314-10 35 x 10 mm
- 19314-12 80 x 12 mm
- 19314-14 70 x 14 mm
- 19314-15 35 x 15 mm
- 19314-16 80 x 16 mm
- 19314-20 60 x 20 mm
- 19330-40 40 x 12 mm
- 19330-55 55 x 11 mm

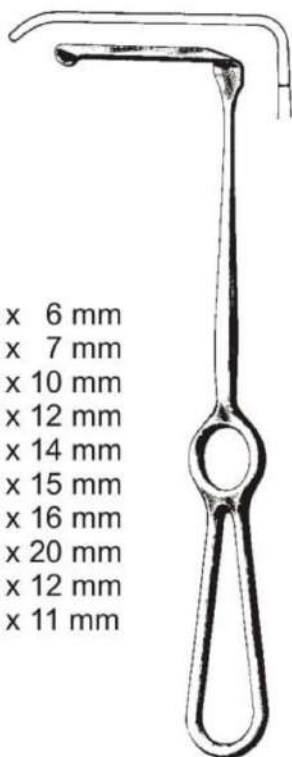

KOCHER-LANGENBECK
 21 cm, 8¹/₄"



GREEN
 19348-22
 22 cm, 8³/₄"



LANGENBECK
 19312-01 - 19312-05
 21 cm, 8¹/₄"

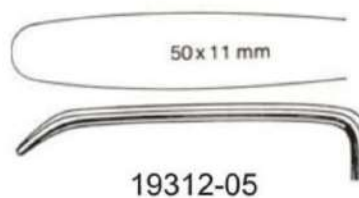
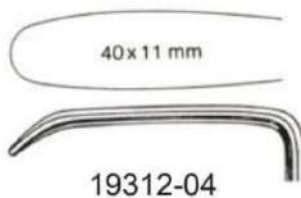
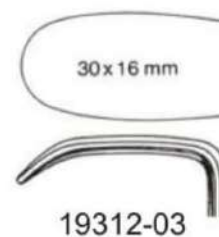
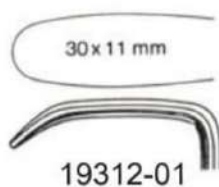

Wundhaken für Mund-Kiefer-Gesicht
Retractors for Mouth-, Jaw- and Face Surgery
Separadores para cirugía plástica
Divaricatori per chirurgia plastica

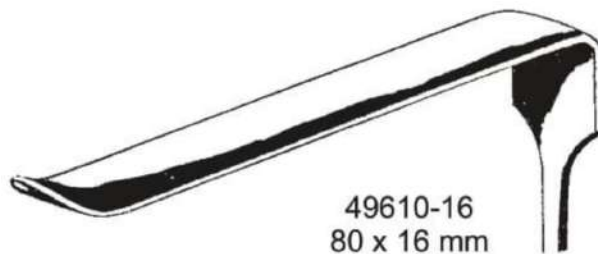
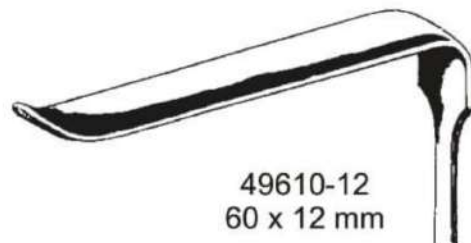
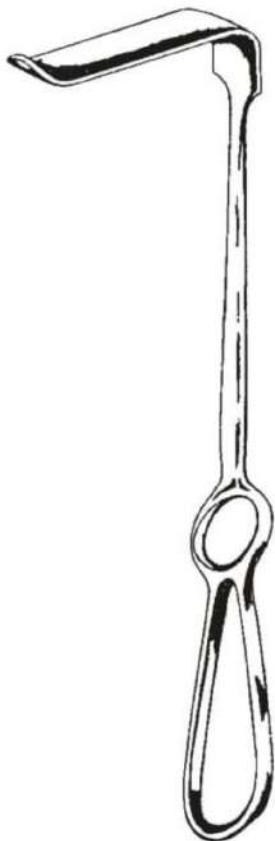
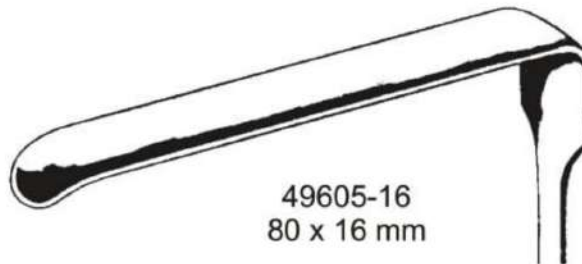
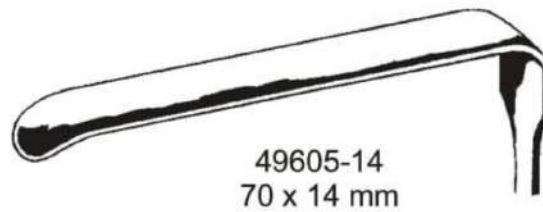
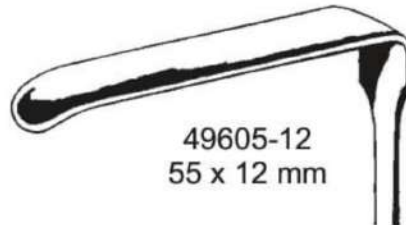
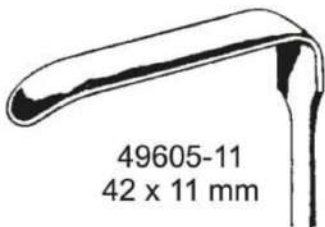
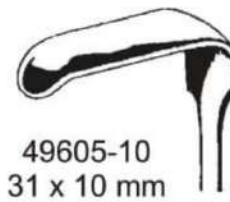

Wundhaken für Mund-Kiefer-Gesicht
Retractors for Mouth-, Jaw- and Face Surgery
Separadores para cirugía plástica
Divaricatori per chirurgia plastica



SPINA-NASALIS
49613-10
22 cm, 8³/₄"

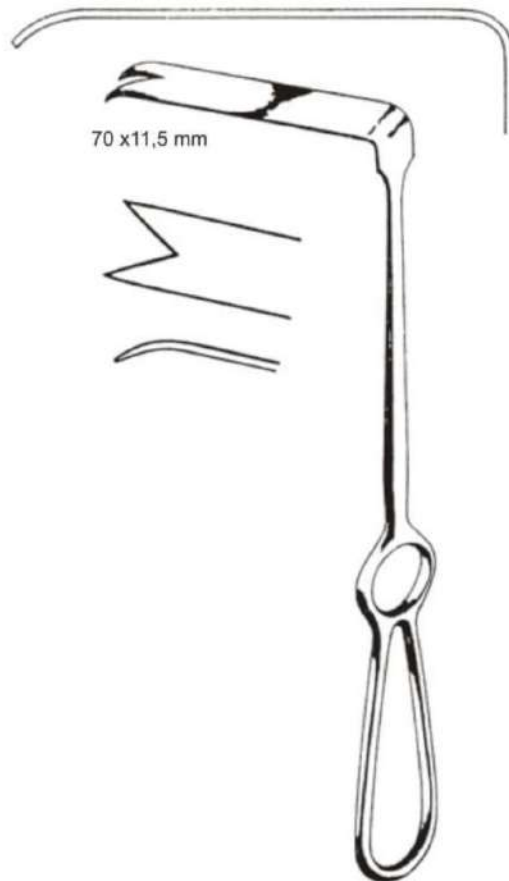

RAMUS
49615-12
22 cm, 8³/₄"



OBWEGESER
49620-15
15,5 cm, 6"

Knopfsonden, Watteträger
 Probes, cotton applicators
 Sondas abotonadas, porta algodones
 Sonde a bottone, porta cotoni



	1 mm ø	1,5 mm ø	2 mm ø		FARRELL
11,5 cm, 4 1/2"	21104-11	21105-11	21106-11	4 3/4"	21270-12 12,0 cm
13,0 cm, 5 1/8"	21104-13	21105-13	21106-13	5 1/2"	21270-14 14,0 cm
14,5 cm, 5 3/4"	21104-14	21105-14	21106-14	6 1/2"	21270-16 16,5 cm
16,0 cm, 6 1/4"	21104-16	21105-16	21106-16	7"	21270-18 18,0 cm
18,0 cm, 7"	21104-18	21105-18	21106-18	9"	21270-23 23,0 cm
20,0 cm, 8"	21104-20	21105-20	21106-20		
25,0 cm, 10"	21104-25	21105-25	21106-25		

rostfrei
 stainless steel
 acero inoxidable
 acciaio inossidabile

geknöpft



BOWMAN

Fig.		Ø mm
0000/000	43613-00	0,6/0,7
00/0	43614-00	0,7/0,8
0/1	43614-01	0,8/0,9
1/2	43614-12	0,9/1,1
2/3	43614-23	1,1/1,3
3/4	43614-34	1,3/1,4
4/5	43614-45	1,4/1,5
5/6	43614-56	1,5/1,6
6/7	43614-67	1,6/1,8
7/8	43614-78	1,8/1,9

Tamponstopfer
 Gauze Packers
 Taponeadores
 Tamponatori



LUNIATSCHEK
 19 cm, 7 3/4"

	Ø mm
51150-19	2 mm
51151-19	3 mm

Nadelhalter
Needle Holders
Porta-agujas
Port'aghi



DERF

25110-12 12 cm, 4³/₄"
25114-12 TC 12 cm, 4³/₄"



WEBSTER

25128-13 13 cm, 5 1/8"
25129-13 TC 13 cm, 5 1/8"

glatt
smooth
lisa
liscia



HALSEY

25130-13 25140-13
25134-13 TC 25144-13 TC
13 cm, 5 1/8"



BAUMGARTNER

25150-12 25154-12 TC
12,5 cm, 5"
25150-14 25154-14 TC
14,0 cm, 5 1/2"



CRILE-WOOD

25160-15 15 cm, 6" 25164-15 TC
25160-18 18 cm, 7" 25164-18 TC



CRILE-MURRAY

25170-15 25174-15 TC
15 cm, 6"

Mikro-Nadelhalter, Nadelhalter
 Micro Needle Holders, Needle Holders
 Micro-porta-agujas, Porta-agujas
 Micro portaghi, Port'aghi



MAYO-HEGAR

- | | | |
|----------|---------------|-------------|
| 25180-14 | 14 cm, 5 1/2" | 25184-14 TC |
| 25180-16 | 16 cm, 6 1/4" | 25184-16 TC |
| 25180-18 | 18 cm, 7" | 25184-18 TC |
| 25180-20 | 20 cm, 8" | 25184-20 TC |



fein
 fine
 delicate
 fino

MAYO-HEGAR

- | | | |
|----------|---------------|-------------|
| 25190-16 | 16 cm, 6 1/4" | 25194-16 TC |
| 25190-18 | 18 cm, 7" | 25194-18 TC |



DE BAKEY

- | | |
|-------------|---------------|
| 25214-16 TC | 16 cm, 6 1/4" |
| 25214-18 TC | 18 cm, 7" |
| 25214-20 TC | 20 cm, 8" |



MATHIEU

- | | | |
|----------|---------------|-------------|
| 25450-14 | 14 cm, 5 1/2" | 25452-14 TC |
| 25450-17 | 17 cm, 6 3/4" | 25452-17 TC |
| 25450-20 | 20 cm, 8" | 25452-20 TC |



LICHTENBERG

- | | |
|-----------|-------------|
| 25466-20 | 25467-20 TC |
| 20 cm, 8" | |



CASTROVIEJO

mit Sperre
 with lock
 con cremallera
 con cremagliera



- | | |
|-----------------|-------------|
| 14,0 cm, 5 1/2" | |
| 25670-14 | 25671-14 |
| 25674-14 TC | 25675-14 TC |

mit TC 1,4 mm
 with TC jaw 1,4 mm
 con TC 1,4 mm
 con morso in TC 1,4 mm



- | | |
|-----------------|-------------|
| 14,0 cm, 5 1/2" | |
| 25672-14 | 25673-14 |
| 25676-14 TC | 25677-14 TC |
| 18,0 cm, 7" | |
| 25668-18 TC | 25691-18 TC |

Scharfe Löffel, Raspeln
 Bone Currettes, Rasps
 Cucharillas cortantes, Escofinas
 Curette taglianti, Raspa

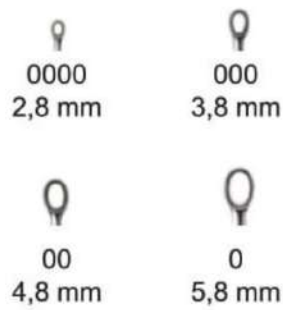

VOLKMANN
 17,0 cm, 6³/₄" Fig.
 33469-96 0000
 33469-97 000
 33469-98 00
 33470-00 0



WILLIGER
 13,5 cm, 5¹/₄" Fig.
 33496-00 00/0
 33496-01 0/1
 33496-12 1/2

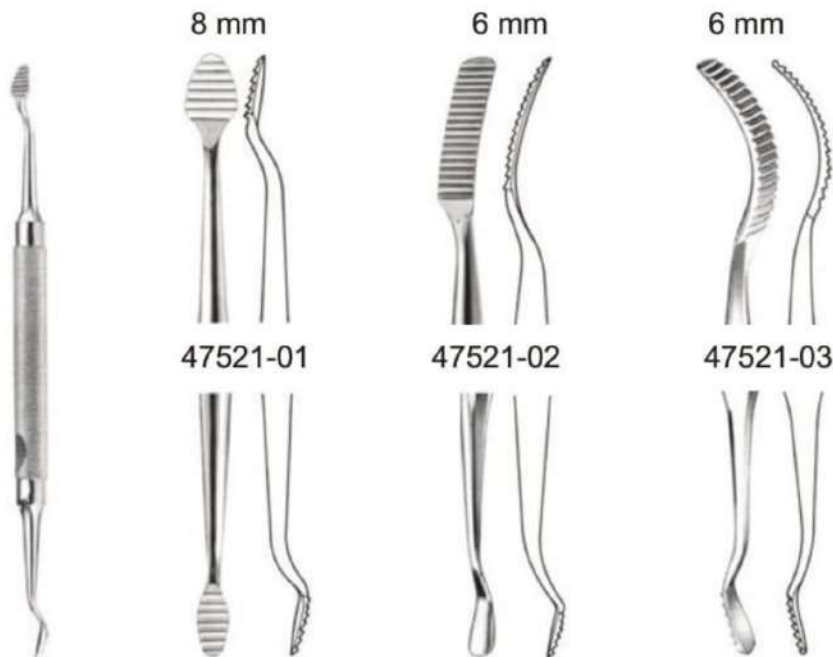

MILLER
 18 cm, 7"

47521-01

47521-02

47521-03

5 mm

4,3 mm

5 mm

Osteotome, Hämmer
 Osteotome, Mallets
 Osteótomo, Martillos
 Osteotomia, Martelli

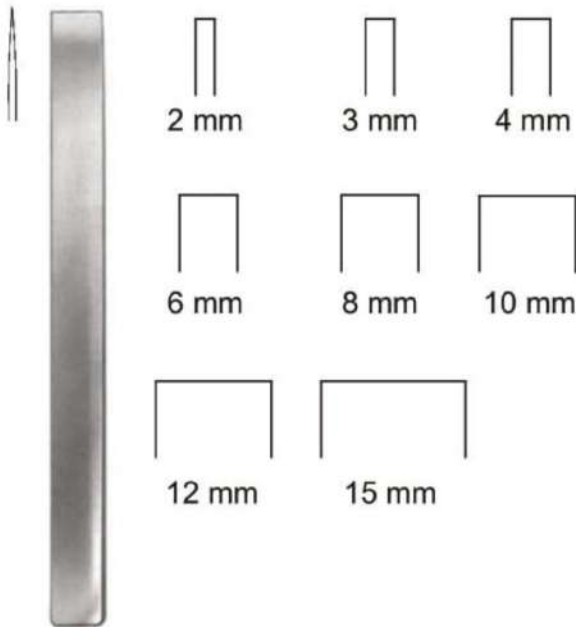

MINI-LAMBOTTE

12,5 cm, 5"	mm	17 cm, 6 ³ / ₄ "
33654-02	2	33652-02
33654-03	3	33652-03
33654-04	4	33652-04
33654-06	6	33652-06
33654-08	8	33652-08
33654-10	10	33652-10
33654-12	12	33652-12
33654-15	15	33652-15

PARTSCH

13,5 cm, 6 ³ / ₄ "	mm	17 cm, 6 ³ / ₄ "
33620-02	2	33622-02
33620-03	3	33622-03
33620-04	4	33622-04
33620-05	5	33622-05
33620-06	6	33622-06
33620-07	7	33622-07
33620-08	8	33622-08

PARTSCH

13,5 cm, 6 ³ / ₄ "	mm	17 cm, 6 ³ / ₄ "
33623-02	2	33625-02
33623-03	3	33625-03
33623-04	4	33625-04
33623-05	5	33625-05
33623-06	6	33625-06
33623-07	7	33625-07
33623-08	8	33625-08

Ø 26 mm



WILLIGER
 24 cm, 9¹/₂"
 33691-34 340 g

massiv, mit auswechselbaren Ferrozellbacken
 solid, with interchangeable Ferrozell jaws
 macizo, con tapas intercambiables de Ferrozell
 solido, con placche intercambiabili in Ferrozell

Ø 20 mm



MEAD
 17 cm, 6³/₄"
 33693-32 320 g

33693-33
 Paar Ersatzbacken
 Pair spare jaws
 par de tapas de repuesto
 Coppia di placche di ricambio

33693-34
 Satz Ringe
 Set rings
 juego de anillos
 Set anelli

Elevatorium, Raspatorien
 Elevator, Raspatories
 Elevador, Periostótomos
 Elévateur, Periostotomi

4 mm



WILLIGER
 33711-16
 16 cm, 6 1/4"

6,5 mm



WILLIGER
 33712-16
 16 cm, 6 1/4"

5 mm



WILLIGER
 33713-16
 16 cm, 6 1/4"

5,5 mm



WILLIGER
 33713-17
 17 cm, 6 1/4"



MOLT
 33716-18
 18 cm, 7"



OBWEGESER
 49627-01
 21 cm, 8 1/4"



OBWEGESER
 49630-02
 21 cm, 8 1/4"

Hohlmeißelzangen
 Bone Rongeurs
 Pinzas-gubias
 Pinze scorbie



FRIEDMAN Mini
 33101-12 12 cm, 4³/₄"



FRIEDMAN
 33101-14 14 cm, 5¹/₂"



CLEVELAND
 33103-14 14 cm, 5¹/₂"



CLEVELAND
 33105-17 17 cm, 6³/₄"



LUER
 33131-15
 15 cm, 5.9"



LUER
 33133-15
 15 cm, 5.9"



BEYER
 33201-18
 18 cm, 7"



MAYFIELD
 33202-18
 18 cm, 7"

Hohlmeißelzangen, Knochensplitterzangen
 Bone Rongeurs, Bone cutting forceps
 Pinzas-gubias, Pinzas cortantes para hueso
 Pinze sgorbie, Pince coupantes à os



ZAUFAL-JANSEN
 33205-18
 18 cm, 7"



— BÖHLER —
 33211-15 33213-15
 15 cm, 6"



— RUSKIN —
 33216-18 33217-18
 18 cm, 7"



— BÖHLER —
 33280-15 33281-15
 15 cm, 6"



Kieferhöhlenstanze
 Antrum Punch Forceps
 Pinzas cortantes para maxilares
 Pinze taglianti per seno mascellare

- 3 x 3 mm 47303-03
- 4 x 4 mm 47303-04
- 5 x 5 mm 47303-05
- 6 x 6 mm 47303-06

KERRISON
 17 cm, 6³/₄"

Saugeraufsätze, Saugrohre
 Suction tips, suction tubes
 Punta de succión, tubos de aspiración
 Punte per aspirazione, tubi d aspirazione



FRAZIER/FERGUSSON
 41295-06 – 41297-12
 19 cm, 7 1/2"

mm	Charr.		↗	
	F.G.	30°	75°	
2,0	6	41295-06	41297-06	
2,3	7	41295-07	41297-07	
2,7	8	41295-08	41297-08	
3,0	9	41295-09	41297-09	
3,3	10	41295-10	41297-10	
3,7	11	41295-11	41297-11	
4,0	12	41295-12	41297-12	
5,0	15	41295-15		



COUPLAND
 05180-17
 17 cm, 6 3/4"

Spitze seitlich perforiert
 tip laterally perforated
 punta perforada lateralmente
 punta con perforazione laterale



9 cm, 3 1/2"



05180-15
 Ø 1,5 mm



05180-20
 Ø 2,0 mm



05180-25
 Ø 2,5 mm



05180-35
 Ø 3,5 mm

Fingerschützer, Mundkeil
Finger Protectors, Oral wedges
Dedales, Abreboca
Proteggidita, Apribocca



34480-01



34480-02



34480-03

LANGENBECK
34480-01 - 34480-03

Holz
wood
madera
legno



MAUNDER
49360-10

Zungendrucker
Tongue Depressors
Baja-lenguas
Abassalingua

Holz
wood
madera
legno



49102-16
16 cm, 6¼"
Pack. à 100

15 mm



19 mm

BRUENINGS
49107-19
19 cm, 7½"

20 mm



20 mm

CAWOOD-MINNESOTA
49108-15
15 cm, 6"



HARTMANN
49111-15
15 cm, 6"



49115-01
Fig. 1
14 cm, 5½"



49115-02
Fig. 2
15 cm, 6"



WIEDER
49115-01 - 49115-02

Wangen- und Lippenhalter, Zungenzangen
 Cheek and Lip Retractor, Tongue Holding Forceps
 Separadores para labios y mejillas, Pinza tira-lenguas
 Divaricatori per guance e labbra, Pinza tiralingua

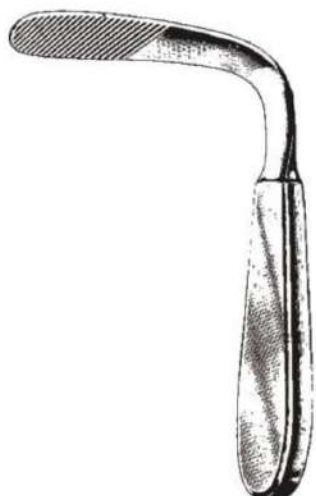

TOBOLD
 49119-14
 14,5 cm, 5¾"



49230-11
 11 cm, 4³/₈"



STERNBERG
 49231-12 12 cm, 4¾"
 49231-14 14 cm, 5½"
 49231-16 16 cm, 6¼"



49235-19
 19 cm, 7½"



COLLIN
 49250-16 16 cm, 6¼"
 49250-18 18 cm, 7"



YOUNG
 49255-16
 16 cm, 6¼"

49255-99
 1 Paar
 1 Pair
 1 pareja
 1 coppia

Lippen- und Wangenhalter
Lip and Cheek Retractors
Sparadores de labios y mejillas
Divaricatori di labbra e guance



Universal
universal
universal
universale

49232-15
15 cm, 6"



für Oberkiefer
for upper jaw
para maxilar
per mascella

49232-21
21 cm, 8¼"



für Unterkiefer
for lower jaw
para mandibula
per mandibola

49232-26
26 cm, 10¼"

Mundsperrer
Mouth Gags
Abre-Bocas
Apribocca



DOYEN-JANSEN (MOLT)
49265-12
12 cm, 4³/₄"

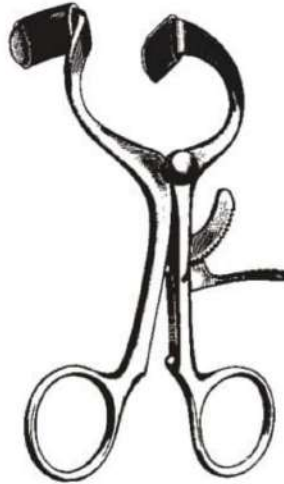

DOYEN-JANSEN (MOLT)
49265-14
14 cm, 5¹/₂"



DENHART
49267-12
12 cm, 4³/₄"



ROSER-KOENIG
49270-16 16 cm, 6¹/₄"
49270-19 19 cm, 7¹/₂"



HEISTER
49272-13
13 cm, 5¹/₈"



JENNINGS
49274-09 9 cm, 3¹/₂"
49274-11 11 cm, 4³/₈"
49274-13 13 cm, 5¹/₈"
49274-15 15 cm, 6"

Mundsperrer
Mouth Gags
Abre-Bocas
Apribocca



49310-10
Sperrer allein, links
Gag only, left
Abre-boca suelta, izquierda
Apribocca solo, sinistra



49310-12
Sperrer allein, rechts
Gag only, right
Abre-boca suelta, derecha
Apribocca solo, destra

für Erwachsene
for adults
para adulto
per adulti

49310-08

Silikoneinlagen/Silicone pads
inserto de silicona/inserto in silicone

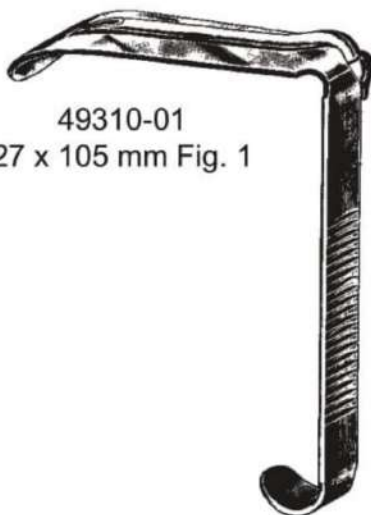

49310-01
27 x 105 mm Fig. 1



49310-02
25 x 90 mm Fig. 2



49310-04
22 x 60 mm Fig. 4



49310-03
25 x 75 mm Fig. 3



49310-05
20 x 25 mm Fig. 5

DAVIS-BOYLE
49310-00
compl.

Mundsperrer
Mouth Gags
Abre-Bocas
Apribocca

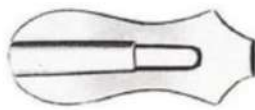

49317-01
24 x 62 mm
Fig. 1



49317-02
28 x 65 mm
Fig. 2

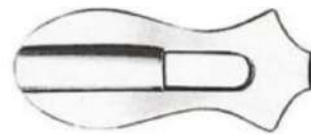

49317-03
31 x 75 mm
Fig. 3



DINGMANN
49317-10
Sperrer allein, Gag only
Abre-boca solo, Apribocca solo

49317-00
DINGMANN, complete

mit 3 auswechselbaren Zungendrucker,
2 seitliche Wangenhaken und 2 Zahnhaken

with 3 interchangeable tongue depressors,
2 rotating cheek holders
2 movable tooth hooks and thread guide

con 3 baja lenguas intercambiables,
2 valvas giratorias p. los labios,
2 ganchos graduables

con 3 depressori intercambiabili,
2 valve laterali rotative
2 uncini a denti mobile

Mundsperrer
Mouth Gags
Abre-Bocas
Apribocca

49320-20
Silikon-Schlauch
Silicon Tubing
tubo de silicona
tubo in silicone



McIVOR
49320-00
compl.

49320-10



49320-01
27 x 95 mm Fig. 1



49320-02
22 x 85 mm Fig. 2



49320-03
22 x 70 mm Fig. 3

Bruststütze
Chest support
Soporte de pecho
Supporto per petto

NEGUS
49400-01



Nagelscheren, Nagelhautzangen
 Nail Scissors, Cuticle Nippers
 Tijeras para uñas, Pinzas y Tjeras cuticulares
 Forbici per unghie, Tronchesine per unghie e pelle



75301-10



75304-10 10 cm, 4" 75305-10



75373-10
 10,5 cm, 4"

Nagelfeilen
 Nail Files
 Limas para uñas
 Limette per le unghie



75382-16

stainless steel



75450-13
 concave



14,5 cm, 5³/₄"



75460-13
 gerade
 straight
 recto
 retta

Nagelzangen
 Nail Nippers
 Alicates corta-uñas
 Tronchesini per unghie



75630-12
 12 cm, 4³/₄"

Bürstenspender, Handwaschbürsten
Brush Dispensor, Nail brushes
Dispensador de cepillos, Cepillo para uñas
Distributore di spazzole, Spazzole per unghie

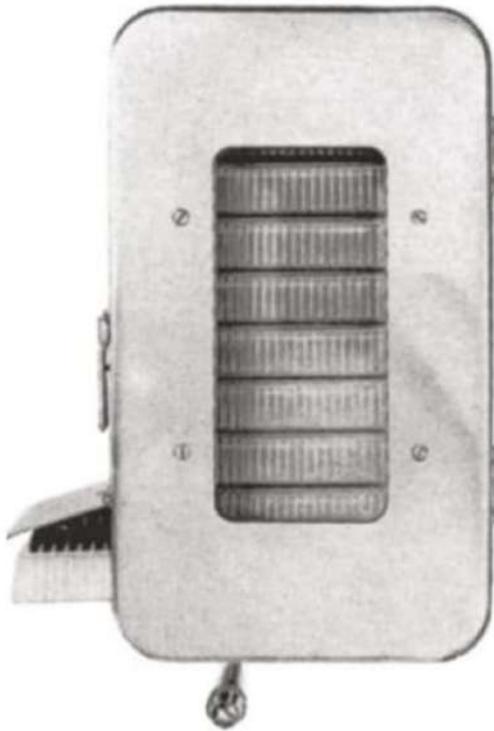

75396-01

Bürstenspender für 10 Bürsten
Brush dispenser for 10 brushes
Distribuidor de cepillos para 10 cepillos
Distributore per spazzolini da 10

75396-02

Bürstenspender für 20 Bürsten
Brush dispenser for 20 brushes
Distribuidor de cepillos para 20 cepillos
Distributore per spazzolini da 20

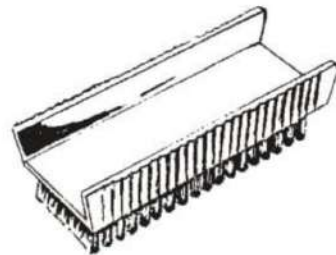

75397-00

Pack. à 10 St.
Box of 10 pcs
caja de 10 pzas.
confezione da 10 pezzi

Zahnzangen, Englische Form
 Extracting forceps, English pattern
 Fórceps dentales, forma inglesa
 Pinze per estrazione, forma inglese



87000-01
 Fig. 1

Seitliche Schneidezähne und Prämolaren, Oberkiefer
 Incisors and bicuspid, upper jaw
 Incisivos y premolares, mandibula superior
 Denti incisivi laterali e denti premolari, mascella superiore



87000-02
 Fig. 2

Schneide- und Eckzähne, Unterkiefer
 Incisors and cuspids, lower jaw
 Incisivos y caninos, mandibula inferior
 Denti incisivi e denti canini, mascella inferiore



87000-04
 Fig. 4

Prämolaren, Oberkiefer
 Bicuspid, upper jaw
 Premolares, mandibula superior
 Denti premolari, mascella superiore



87000-07
 Fig. 7

Prämolaren, Unterkiefer
 Bicuspid, lower jaw
 Premolares, mandibula inferior
 Denti premolari, mascella inferiore



87000-13
 Fig. 13

Zahnzangen, Englische Form
 Extracting forceps, English pattern
 Fórceps dentales, forma inglesa
 Pinze per estrazione, forma inglese

Molaren, rechts, Oberkiefer
 Molars, right, upper jaw
 Molares, derecho, mandibula superior
 Denti molari, destra, mascella superiore

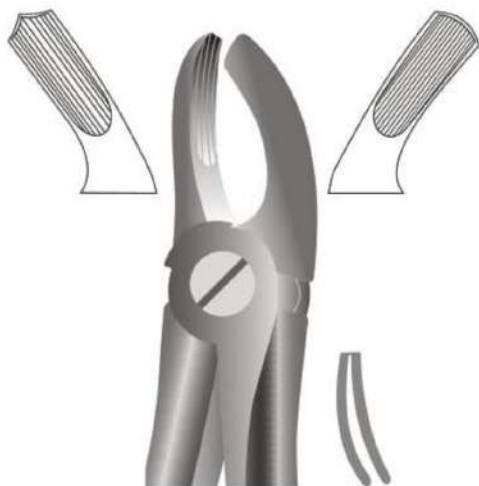

87000-17
 Fig. 17

Molaren, links, Oberkiefer
 Molars, left, upper jaw
 Molares, izquierdo, mandibula superior
 Denti molari, sinistra, mascella superiore

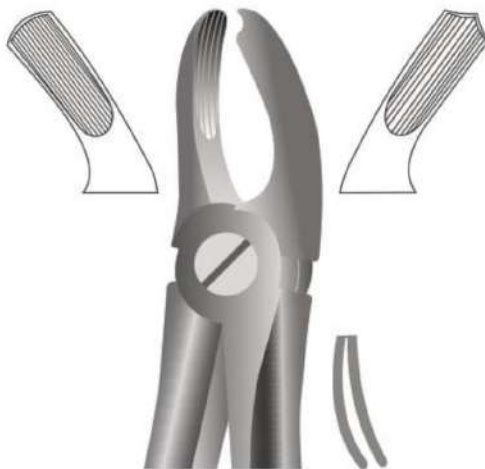

87000-18
 Fig. 18

Molaren, Oberkiefer
 Molars, upper jaw
 Molares, mandibula superior
 Denti molari, mascella superiore

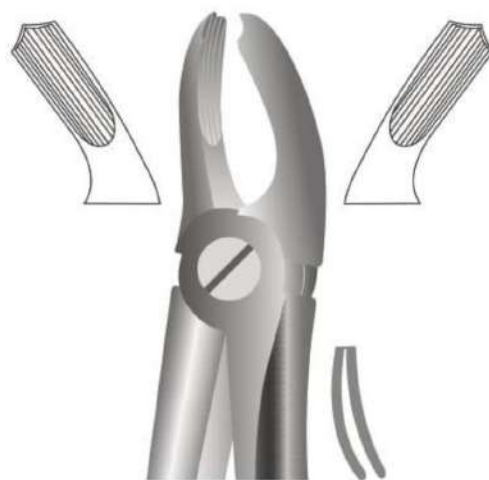

87000-18A
 Fig. 18 A

Molaren, Unterkiefer
 Molars, lower jaw
 Molares, mandibula inferior
 Denti molari, mascella inferiore



87000-22
 Fig. 22

Molaren, rechts, Unterkiefer
 Molars, right, lower jaw
 Molares, derecho, mandibula inferior
 Denti molari, destra, mascella inferiore



87000-23
 Fig. 23

Molaren, links, Unterkiefer
 Molars, left, lower jaw
 Molares, izquierdo, mandibula inferior
 Denti molari, sinistra, mascella inferiore



87000-24
 Fig. 24

Wurzeln und Schneidezähne, Oberkiefer
 Roots and incisors, upper jaw
 Raíces y incisivos, mandibula superior
 Radici e denti incisivi, mascella superiore



87000-29
 Fig. 29

Zahnzangen, Englische Form
 Extracting forceps, English pattern
 Fórceps dentales, forma inglesa
 Pinze per estrazione, forma inglese

Wurzeln, Unterkiefer
 Roots, lower jaw
 Raíces, mandíbula inferior
 Radici, mascella inferiore

Wurzeln, schlankes Maul, Unterkiefer
 Roots, slender jaw, lower jaw
 Raíces, boca delgada, mandíbula inferior
 Radici, morso delicato, mascella inferiore

Wurzeln, mit Haftprofil, Unterkiefer
 Roots, with anti-slip gripping surface, lower jaw
 Raíces, con superficie de adhesión, mandíbula inferior
 Radici, mascella inferiore, con profilo adesivo



87000-33
 Fig. 33

87000-33A
 Fig. 33 A

87000-33M
 Fig. 33 M

87000-33C
 Fig. 33 C

Schneidezähne und Prämolaren tiefgreifend, Oberkiefer
 Incisors and bicuspid deep-gripping, upper jaw
 Incisivos y premolares a gran calado, mandíbula superior
 Denti incisivi e denti premolari profondo, mascella superiore

Prämolaren, tiefgreifend, Unterkiefer
 Bicuspid, deep-gripping, lower jaw
 Premolares, a gran calado, mandíbula inferior
 Denti premolari, profondo, mascella inferiore



87000-34N
 Fig. 34 N

87000-35N
 Fig. 35 N

87000-36
 Fig. 36

Zahnzangen, Englische Form
 Extracting forceps, English pattern
 Fórceps dentales, forma inglesa
 Pinze per estrazione, forma inglese

Wurzeln, sehr fein, Unterkiefer
 Roots, very fine, lower jaw
 Raíces muy delgadas, mandibula inferior
 Radici, molto fini, con profilo adesivo

Prämolaren, tiefgreifend, Unterkiefer
 Bicuspid, deep-gripping, lower jaw
 Premolares, a gran calado, mandibula inferior
 Denti premolari, profondo, con profilo adesivo

Wurzeln, Oberkiefer
 Roots, upper jaw
 Raíces, mandibula superior
 Radici, mascella superiore



87000-46L
 Fig. 46 L



87000-46LX
 Fig. 46 LX



87000-46N
 Fig. 46 N



87000-49
 Fig. 49

Wurzeln, Oberkiefer
 Roots, upper jaw
 Raíces, mandibula superior
 Radicii, mascella superiore



87000-51
 Fig. 51



87000-51A
 Fig. 51 A



87000-51C
 Fig. 51 C

Zahnzangen, Englische Form
 Extracting forceps, English pattern
 Fórceps dentales, forma inglesa
 Pinze per estrazione, forma inglese

Weisheitszähne, Oberkiefer
 Third molars, upper jaw
 Terceros molares, mandibula superior
 Denti del giudizio, mascella superiore

Weisheitszähne, tiefgreifend, Oberkiefer
 Third molars, deep-gripping, upper jaw
 Terceros molares, a gran calado, mandibula superior
 Denti del giudizio, profondo, mascella superiore



87000-67
 Fig. 67



87000-67A
 Fig. 67 A



87000-67N
 Fig. 67 N

Molaren, Unterkiefer
 Molars, lower jaw
 Molares, mandibula inferior
 Denti molari, mascella inferiore

Schneidezähne und Wurzeln, Unterkiefer
 Incisors and roots, lower jaw
 Incisivos y raíces, mandibula inferior
 Denti incisivi e radici, mascella inferiore

Schneidezähne und Wurzeln, Unterkiefer
 Incisors and roots, lower jaw
 Incisivos y raíces, mandibula inferior
 Denti incisivi e radici, mascella inferiore



87000-73
 Fig. 73



87000-74
 Fig. 74



87000-74N
 Fig. 74 N



87000-74NX
 Fig. 74 NX

Zahnzangen, Englische Form
 Extracting forceps, English pattern
 Fórceps dentales, forma inglesa
 Pinze per estrazione, forma inglese

Eckzähne und Prämolaren, Unterkiefer
 Cuspids and bicuspid, lower jaw
 Caninos y premolares, mandibula inferior
 Denti canini e denti premolari, mascella inferiore

Wurzeln, Oberkiefer
 Roots, upper jaw
 Raíces, mandibula superior
 Radici, mascella superiore



87000-75
 Fig. 75

87000-76
 Fig. 76

LAWRENCE-READ

87000-76N
 Fig. 76 N

Weisheitszähne, Unterkiefer
 Third molars, lower jaw
 Terceros molares, mandibula inferior
 Denti del giudizio, mascella inferiore

Weisheitszähne, tiefgreifend, Unterkiefer
 Third molars, deep-gripping, lower jaw
 Terceros molares, a gran calado, mandibula inferior
 Denti del giudizio, profondo, mascella inferiore

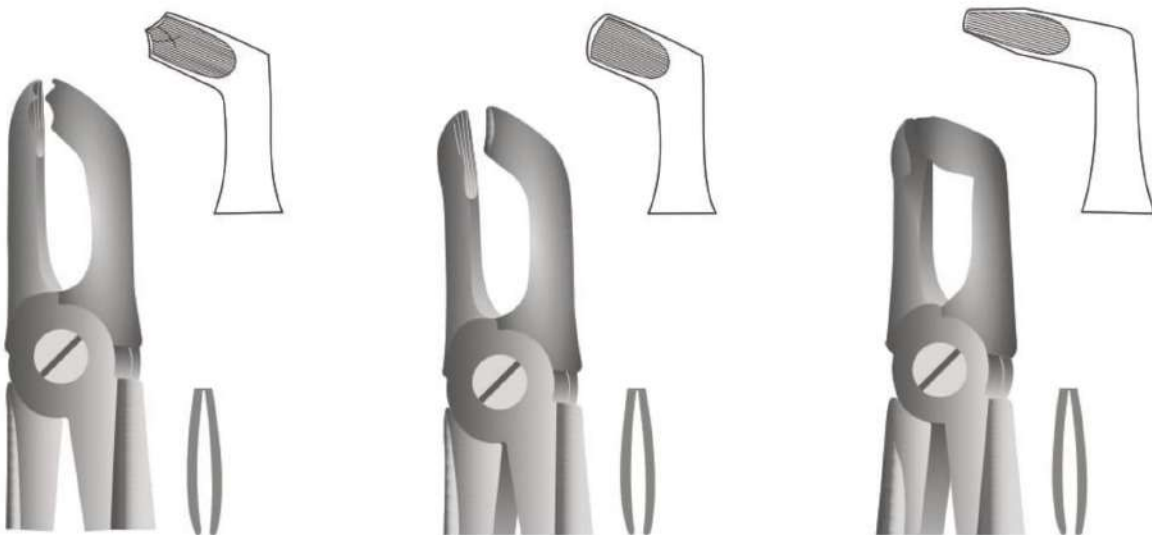

87000-79
 Fig. 79

87000-79A
 Fig. 79 A

87000-79N
 Fig. 79 N

Zahnzangen, Englische Form
 Extracting forceps, English pattern
 Fórceps dentales, forma inglesa
 Pinze per estrazione, forma inglese

Molaren mit kariösen oder abgebrochenen Kronen, Unterkiefer
 Molars with carious or broken caps, lower jaw
 Molares con coronas rotas o cariadas, mandibula inferior
 Denti molari con corone cariate o spezzate, mascella inferiore



87000-86A
 Fig. 86 A



87000-86B
 Fig. 86 B



87000-86C
 Fig. 86 C

Wurzeln, sehr fein, Oberkiefer
 Roots, very fine, upper jaw
 Raíces muy delgadas, mandibula superior
 Radici, molto fini, mascella superiore



87000-97
 Fig. 97

Wurzeln, sehr fein, Unterkiefer
 Roots, very fine, lower jaw
 Raíces, muy delgadas, mandibula inferior
 Radici, molto fini, mascella inferiore



87001-33
 Fig. 133

Wurzelreste, tiefgreifend, Unterkiefer
 Root fragments, deep-gripping, lower jaw
 Fragmentos de raíces, a gran calado, mandibula inferior
 Frammenti di radici, profondo, mascella inferiore



87001-46
 Fig. 146

Zahnzangen, Englische Form
Extracting forceps, English pattern
Fórceps dentales, forma inglesa
Pinze per estrazione, forma inglese

Wurzeln, sehr fein, Oberkiefer
Roots, very fine, upper jaw
Raíces, muy delgadas, mandibula superior
Radici, molto fini, mascella superiore



87001-51
Fig. 151

Wurzelreste, tiefgreifend, Oberkiefer
Root fragments, deep-gripping, upper jaw
Fragmentos de raíces, a gran calado, mandibula superior
Frammenti di radici, profondo, mascella superiore



87001-53
Fig. 153

Wurzeln, mit Parallelmaul, Unterkiefer
Roots, with parallel beak, lower jaw
Raíces, con pico paralelo, mandibula inferior
Radici, morso parallelo, mascella inferiore



87002-33
Fig. 233

Kinderzahnzangen, Englische Form
 Extracting forceps for children, English pattern
 Fórceps dentales para niños, forma inglesa
 Pinze per estrazione per bambini, forma inglese

Prämolaren, Unterkiefer
 Bicuspid, lower jaw
 Premolares, mandibula inferior
 Denti premolari, mascella inferiore

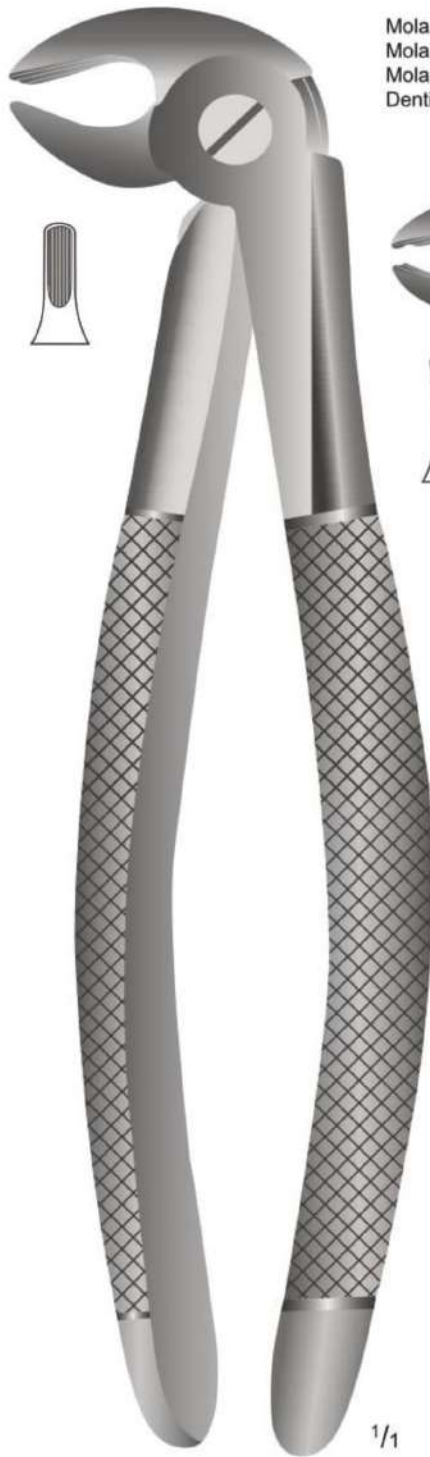

87010-13S
 Fig. 13 S

Molaren, Unterkiefer
 Molars, lower jaw
 Molares, mandibula inferior
 Denti molari, mascella inferiore



87010-22S
 Fig. 22 S

Wurzeln und Schneidezähne, Oberkiefer
 Incisors and roots, upper jaw
 Incisivos y raíces, mandibula superior
 Radici e denti incisivi, mascella superiore



87010-30
 Fig. 30 S

Wurzeln, Unterkiefer
 Roots, lower jaw
 Raíces, mandibula inferior
 Radici, mascella inferiore



87010-33S
 Fig. 33 S

Schneide- und Eckzähne
 Incisors and cuspids
 Incisivos y caninos
 Denti incisivi e denti canini

Oberkiefer
 upper jaw
 mandibula superior
 mascella superiore

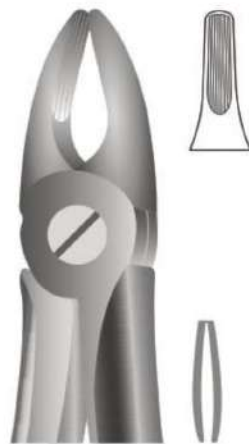

87010-37
 Fig. 37

Unterkiefer
 lower jaw
 mandibula inferior
 mascella inferiore



87010-38
 Fig. 38

Molaren, Oberkiefer
 Molars, upper jaw
 Molares, mandibula superior
 Denti molari, mascella superiore

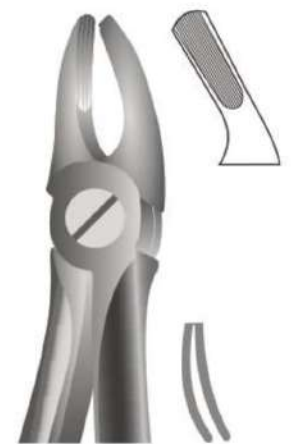

87010-39
 Fig. 39

Kinderzahnzangen, Englische Form
 Extracting forceps for children, English pattern
 Fórceps dentales para niños, forma inglesa
 Pinze per estrazione per bambini, forma inglese

Molaren, Oberkiefer
 Molars, upper jaw
 Molares, mandibula superior
 Denti molari, mascella superiore



87010-39A
 Fig. 39 A

Molaren, links, Oberkiefer
 Molars, left, upper jaw
 Molares, izquierdo, mandibula superior
 Denti molari, sinistra, mascella superiore

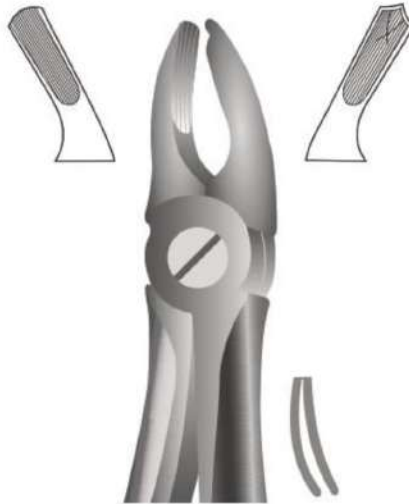

87010-39L
 Fig. 39 L

Molaren, rechts, Oberkiefer
 Molars, right, upper jaw
 Molares, derecho, mandibula superior
 Denti molari, destra, mascella superiore

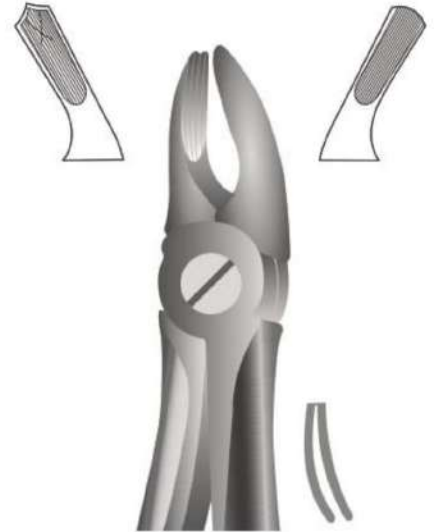

87010-39R
 Fig. 39 R

Molaren, Unterkiefer
 Molars, lower jaw
 Molares, mandibula inferior
 Denti molari, mascella inferiore

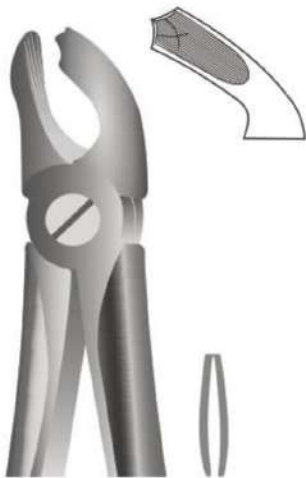

87010-40
 Fig. 40

Wurzeln, Oberkiefer
 Roots, upper jaw
 Raíces, mandibula superior
 Radici, mascella superiore



87010-51S
 Fig. 51 S



LAWRENCE-READ
 87010-76S
 Fig. 76 S

Kinderzahnzangen, Englische Form
 Extracting forceps for children, English pattern
 Fórceps dentales para niños, forma inglesa
 Pinze per estrazione per bambini, forma inglese

Molaren, Oberkiefer
 Molars, upper jaw
 Molares, mandibula superior
 Denti molari, mascella superiore



KLEIN
 87020-03
 Fig. 3

Schneidezähne, Unterkiefer
 Incisors, lower jaw
 Incisivos, mandibula inferior
 Denti incisivi, mascella inferiore



KLEIN
 87020-05
 Fig. 5

Molaren, Unterkiefer
 Molars, lower jaw
 Molares, mandibula inferior
 Denti molari, mascella inferiore

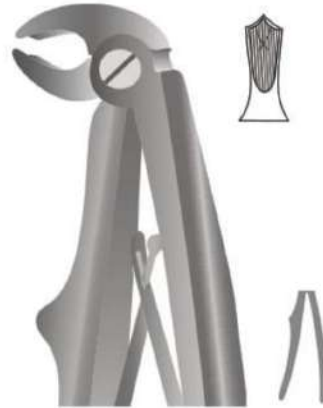

KLEIN
 87020-06
 Fig. 6

Wurzeln, Unterkiefer
 Roots, lower jaw
 Raíces, mandibula inferior
 Radici, mascella inferiore



KLEIN
 87020-07
 Fig. 7

Wurzeln, Oberkiefer
 Roots, upper jaw
 Raíces, mandibula superior
 Radici, mascella superiore



KLEIN
 87020-51S
 Fig. 51 S

Schneide- und Eckzähne, Oberkiefer
 Incisors and cuspids, upper jaw
 Incisivos y caninos, mandibula superior
 Denti incisivi e denti canini, mascella superiore



KLEIN
 87021-37
 Fig. 137

Prämolaren, Oberkiefer
 Biscuspids, upper jaw
 Premolares, mandibula superior
 Denti premolari, mascella superiore



KLEIN
 87021-39
 Fig. 139

Zahnzangen, Amerikanische Form
 Extracting forceps, American pattern
 Fórceps dentales, forma americana
 Pinze per estrazione, forma americana

Schneide- und Eckzähne, Oberkiefer
 Incisors and cuspids, upper jaw
 Incisivos y premolares, mandibula superior
 Denti incisivi e denti canini, mascella superiore



87100-01
 Fig. 1

Schneidezähne, Oberkiefer
 Incisors, upper jaw
 Incisivos, mandibula superior
 Denti incisivi, mascella superiore

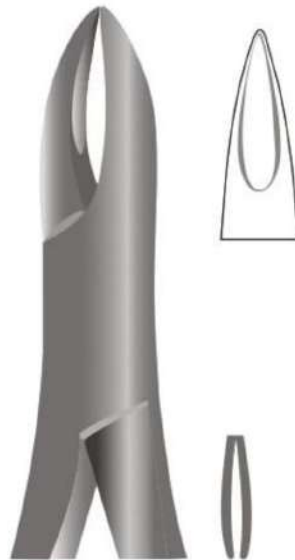

HENAHAN
 87100-01A
 Fig. 1 A

Molaren und Weisheitszähne, Oberkiefer
 Molars and third molars, upper jaw
 Molares y terceros molares, mandibula superior
 Denti molari e denti del giudizio, mascella superiore

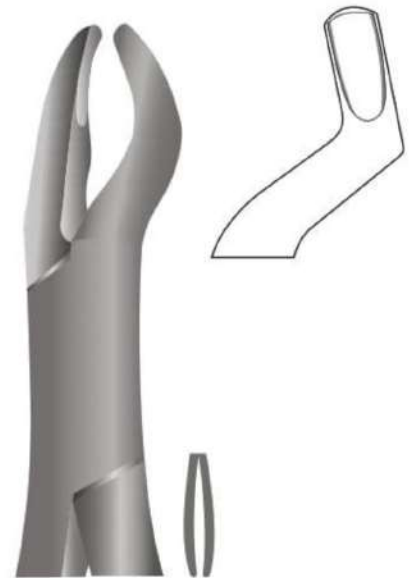

87100-10S
 Fig. 10 S

Molaren, Unterkiefer
 Molars, lower jaw
 Molares, mandibula inferior
 Denti molari, mascella inferiore



87100-15
 Fig. 15

Molaren, schlankes Maul, Unterkiefer
 Molars, slender jaw, lower jaw
 Molares, boca delgada, mandibula inferior
 Denti molari, morso delicato, mascella inferiore

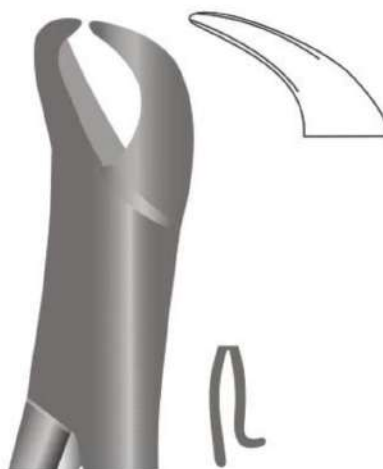

87100-16
 Fig. 16

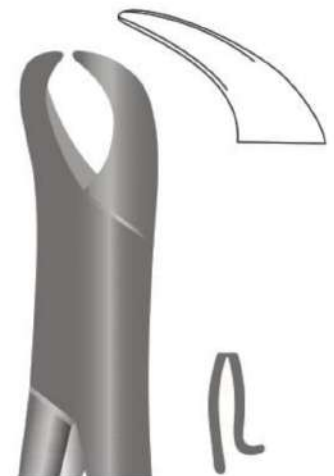

87100-16S
 Fig. 16 S

Zahnzangen, Amerikanische Form
 Extracting forceps, American pattern
 Fórceps dentales, forma americana
 Pinze per estrazione, forma americana

Molaren, Unterkiefer
 Molars, lower jaw
 Molares, mandibula inferior
 Denti molari, mascella inferiore



87100-17
 Fig. 17

Molaren, links, Oberkiefer
 Molars, left, upper jaw
 Molares, izquierdo, mandibula superior
 Denti molari, sinistra, mascella superiore

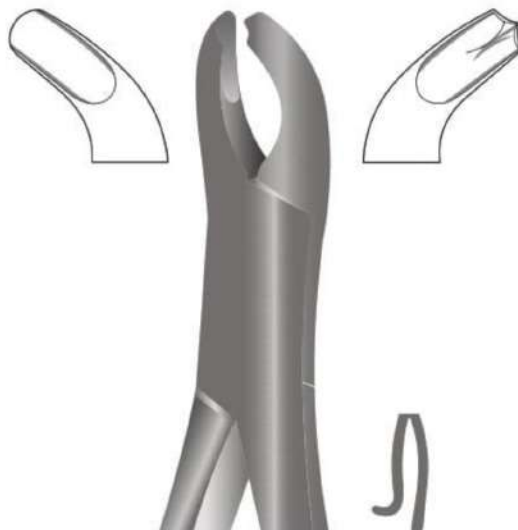

HARRIS
 87100-18L
 Fig. 18 L

Molaren, rechts, Oberkiefer
 Molars, right, upper jaw
 Molares, derecho, mandibula superior
 Denti molari, destra, mascella superiore

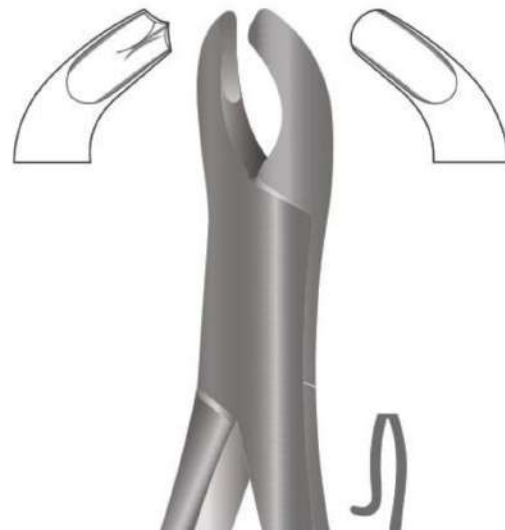

HARRIS
 87100-18R
 Fig. 18 R

Molaren, Unterkiefer
 Molars, lower jaw
 Molares, mandibula inferior
 Denti molari, mascella inferiore



87100-23
 Fig. 23

Molaren und Prämolaren, Oberkiefer
 Molars and bicuspid, upper jaw
 Molares y premolares, mandibula superior
 Denti molari e denti premolari, mascella superiore

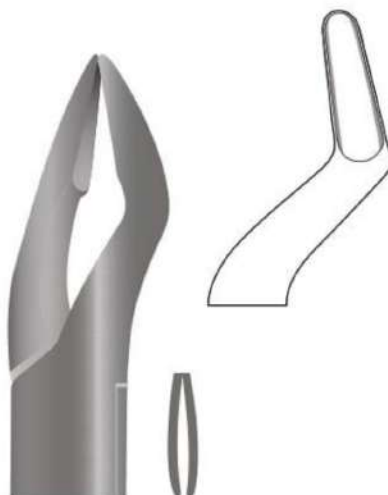

PARMLY
 87100-32
 Fig. 32

Molaren, Prämolaren und Wurzeln, Oberkiefer
 Molars, bicuspid and roots, upper jaw
 Molares, premolares y raíces, mandibula superior
 Denti molari, denti premolari e radici, mascella superiore



PARMLY
 87100-32A
 Fig. 32 A

Zahnzangen, Amerikanische Form
 Extracting forceps, American pattern
 Fórceps dentales, forma americana
 Pinze per estrazione, forma americana

Molaren, links, Oberkiefer
 Molars, left, upper jaw
 Molares, izquierdo, mandibula superior
 Denti molari, sinistra, mascella superiore

Molaren, rechts, Oberkiefer
 Molars, right, upper jaw
 Molares, derecho, mandibula superior
 Denti molari, destra, mascella superiore

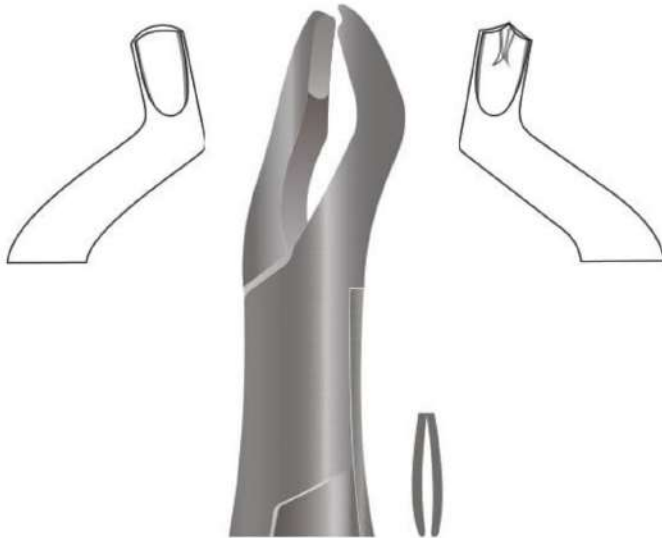

87100-53L
 Fig. 53 L

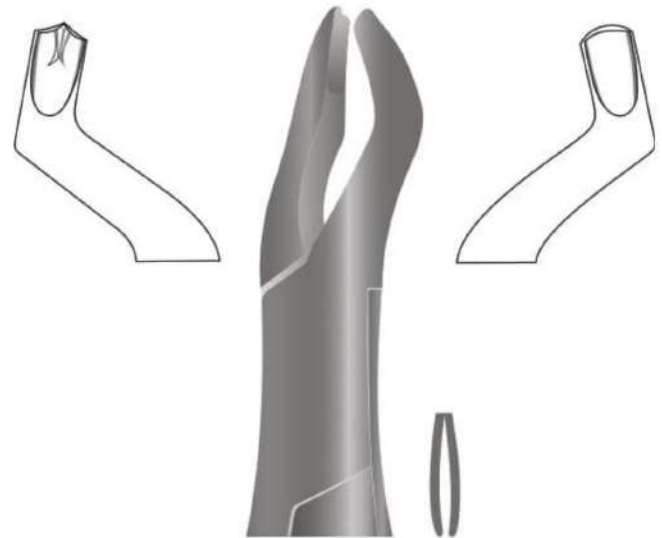

87100-53R
 Fig. 53 R

Universal für Zähne und Wurzeln, Oberkiefer
 Teeth and roots, universal, upper jaw
 Dientes y raíces, universal, mandibula superior
 Denti e radici, universale, mascella superiore

Schneidezähne und Wurzeln, Oberkiefer
 Incisors and roots, upper jaw
 Incisivos y raíces, mandibula superior
 Denti incisivi e radici, mascella superiore

Wurzelsplitter, Oberkiefer
 Root fragments, upper jaw
 Fragmentos de raíces, mandibula superior
 Frammenti di radici, mascella superiore



87100-62
 Fig. 62

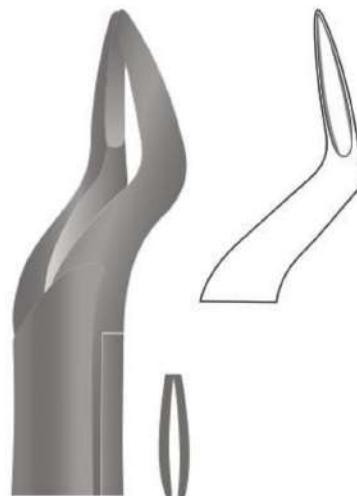

87100-65
 Fig. 65



TOMES
 87100-69
 Fig. 69

Zahnzangen, Amerikanische Form
 Extracting forceps, American pattern
 Fórceps dentales, forma americana
 Pinze per estrazione, forma americana

Molaren, links, Oberkiefer
 Molars, left, upper jaw
 Molares, izquierdo, mandibula superior
 Denti molari, sinistra, mascella superiore

Molaren, rechts, Oberkiefer
 Molars, right, upper jaw
 Molares, derecho, mandibula superior
 Denti molari, destra, mascella superiore

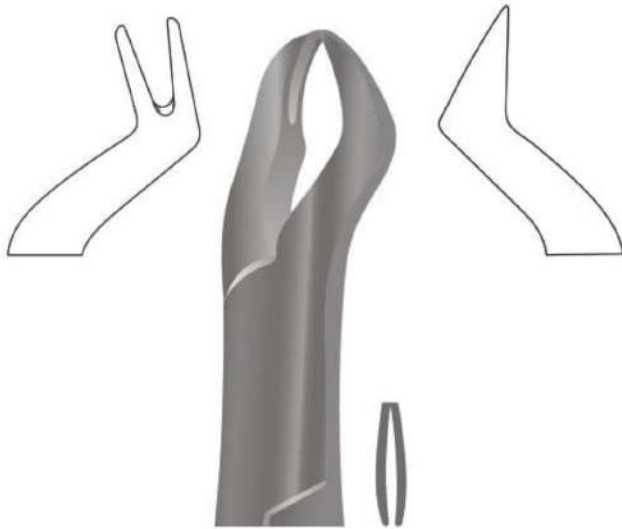

NEVIUS
 87100-88L
 Fig. 88 L

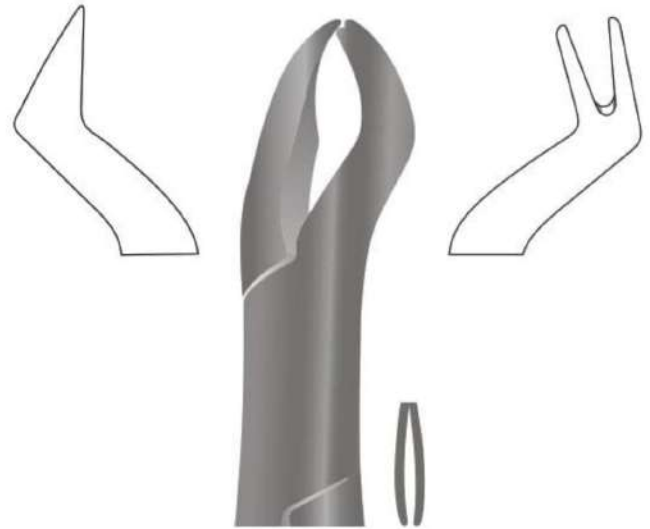

NEVIUS
 87100-88R
 Fig. 88 R

Prämolaren, Schneidezähne und Wurzeln, Oberkiefer
 Biscuspids, incisors and roots, upper jaw
 Premolares, incisivos y raíces, mandibula superior
 Denti premolari, denti incisivi e radici, mascella superiore

Prämolaren, Schneidezähne und Wurzeln, Oberkiefer
 Biscuspids, incisors and roots, upper jaw
 Premolares, incisivos y raíces, mandibula superior
 Denti premolari, denti incisivi e radici, mascella superiore

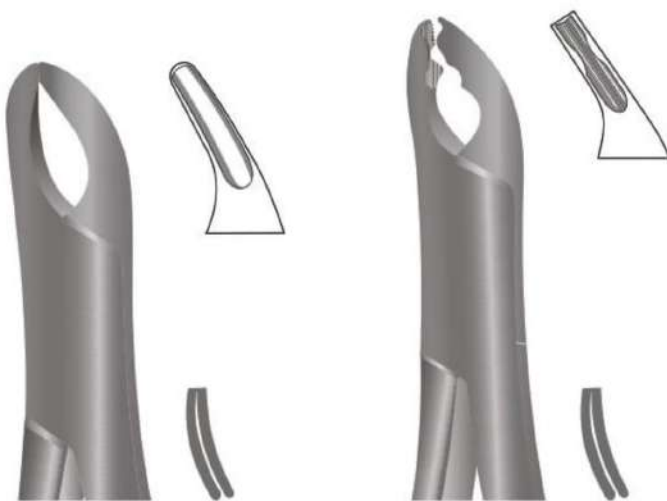

CRYER
 87101-50
 Fig. 150



87101-50AS
 Fig. 150 AS



CRYER
 87101-50H
 Fig. 150



CRYER
 87101-50S
 Fig. 150 S

Zahnzangen, Amerikanische Form
 Extracting forceps, American pattern
 Fórceps dentales, forma americana
 Pinze per estrazione, forma americana

Prämolaren, Schneidezähne und Wurzeln, Oberkiefer
 Bicuspid, incisors and roots, upper jaw
 Premolares, incisivos y raíces, mandibula superior
 Denti premolari, denti incisivi e radici, mascella superiore

Prämolaren, Schneidezähne und Wurzeln, Unterkiefer
 Bicuspid, incisors and roots, lower jaw
 Premolares, incisivos y raíces, mandibula inferior
 Denti premolari, denti incisivi e radici, mascella inferiore

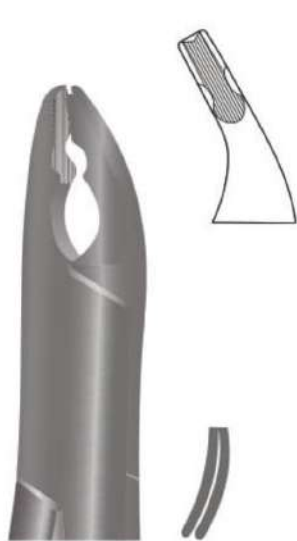

87101-50X
 Fig. 150 X



CRYER
 87101-51
 Fig. 151



CRYER
 87101-51A
 Fig. 151 A



87101-51AS
 Fig. 151 AS

Zähne und Wurzeln, universal, Unterkiefer
 Teeth and roots, universal, lower jaw
 Dientes y raíces, universal, mandibula inferior
 Denti e radici, universale, mascella inferiore

Prämolaren, Schneidezähne und Wurzeln, Unterkiefer
 Bicuspid, incisors and roots, lower jaw
 Premolares, incisivos y raíces, mandibula inferior
 Denti premolari, denti incisivi e radici, mascella inferiore

Weisheitszähne, Unterkiefer
 Third molars, lower jaw
 Terceros molares, mandibula inferior
 Denti del giudizio, mascella inferiore



CRYER
 87101-51S
 Fig. 151 S



CRYER
 87101-51X
 Fig. 151 X



87102-22
 Fig. 222

Zahnzangen, Amerikanische Form
Extracting forceps, American pattern
Fórceps dentales, forma americana
Pinze per estrazione, forma americana

Wurzelsplitterzange, universal, Oberkiefer
Root fragments, universal, upper jaw
Fragmentos de raíces, universal, mandibula superior
Frammenti di radici, universale, mascella superiore

Wurzelsplitterzange, universal, Unterkiefer
Root fragments, universal, lower jaw
Fragmentos de raíces, universal, mandibula inferior
Frammenti di radici, universale, mascella inferiore



WITZEL
87105-01
Fig. 501



WITZEL
87105-02
Fig. 502

Zahnzangen, Amerikanische Form
 Extracting forceps, American pattern
 Fórceps dentales, forma americana
 Pinze per estrazione, forma americana

Molaren, Oberkiefer
 Molars, upper jaw
 Molares, mandibula superior
 Denti molari, mascella superiore

Zähne und Wurzeln, universal, Oberkiefer
 Teeth and roots, universal, upper jaw
 Dientes y raíces, universal, mandibula superior
 Denti e radici, universale, mascella superiore

Molaren, Oberkiefer
 Molars, upper jaw
 Molares, mandibula superior
 Denti molari, mascella superiore



87110-17
 Fig. 17 SK



87110-23
 Fig. 23 SK



87111-50
 Fig. 150 SK

Zähne und Wurzeln, universal, Oberkiefer
 Teeth and roots, universal, upper jaw
 Dientes y raíces, universal, mandibula superior
 Denti e radici, universale, mascella superiore



87111-51
 Fig. 151 SK

Wurzelheber
 Root elevators
 Elevadores para raíces
 Leve per radici

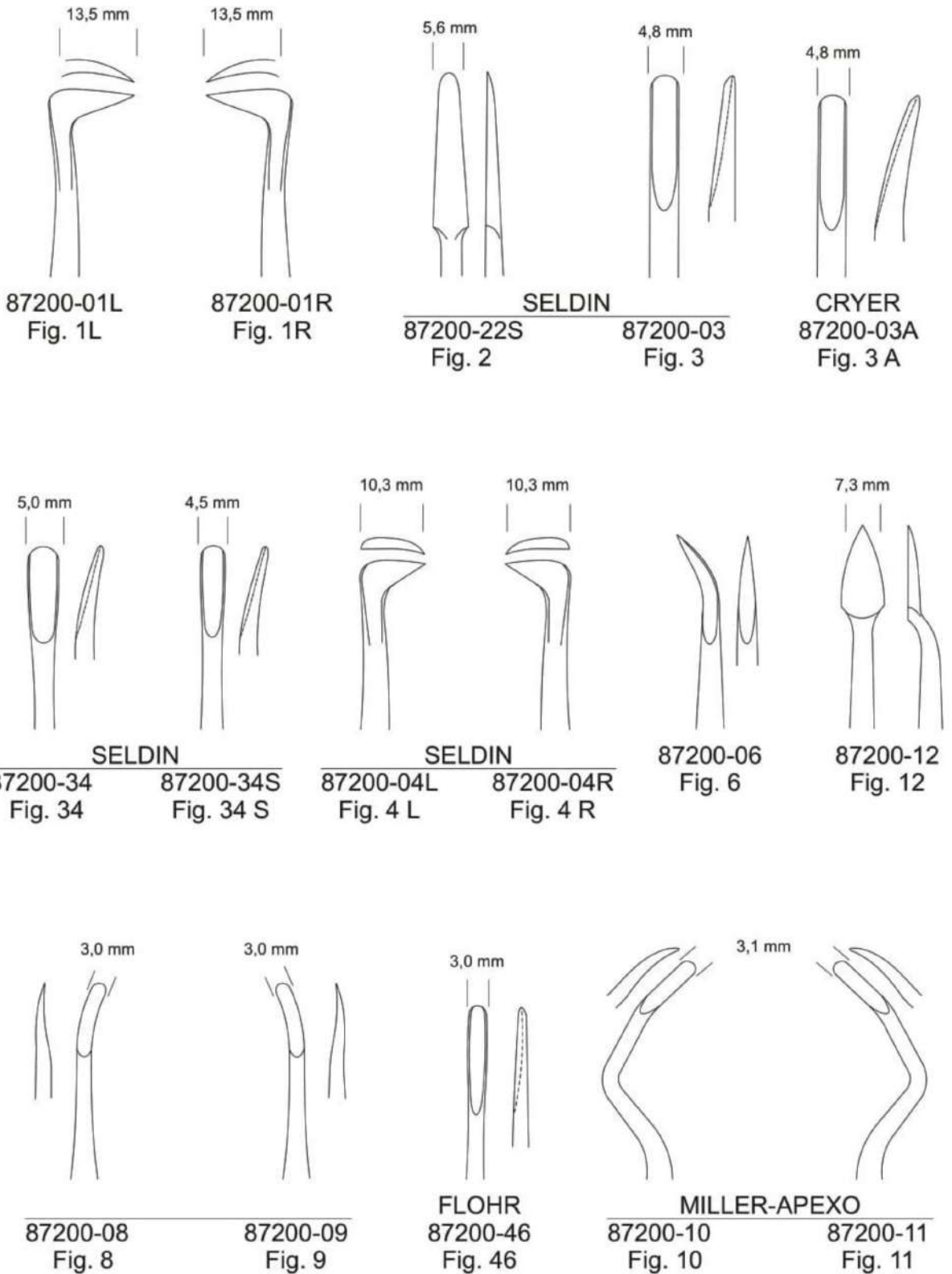

Wurzelheber
Root elevators
Elevadores para raíces
Leve per radici

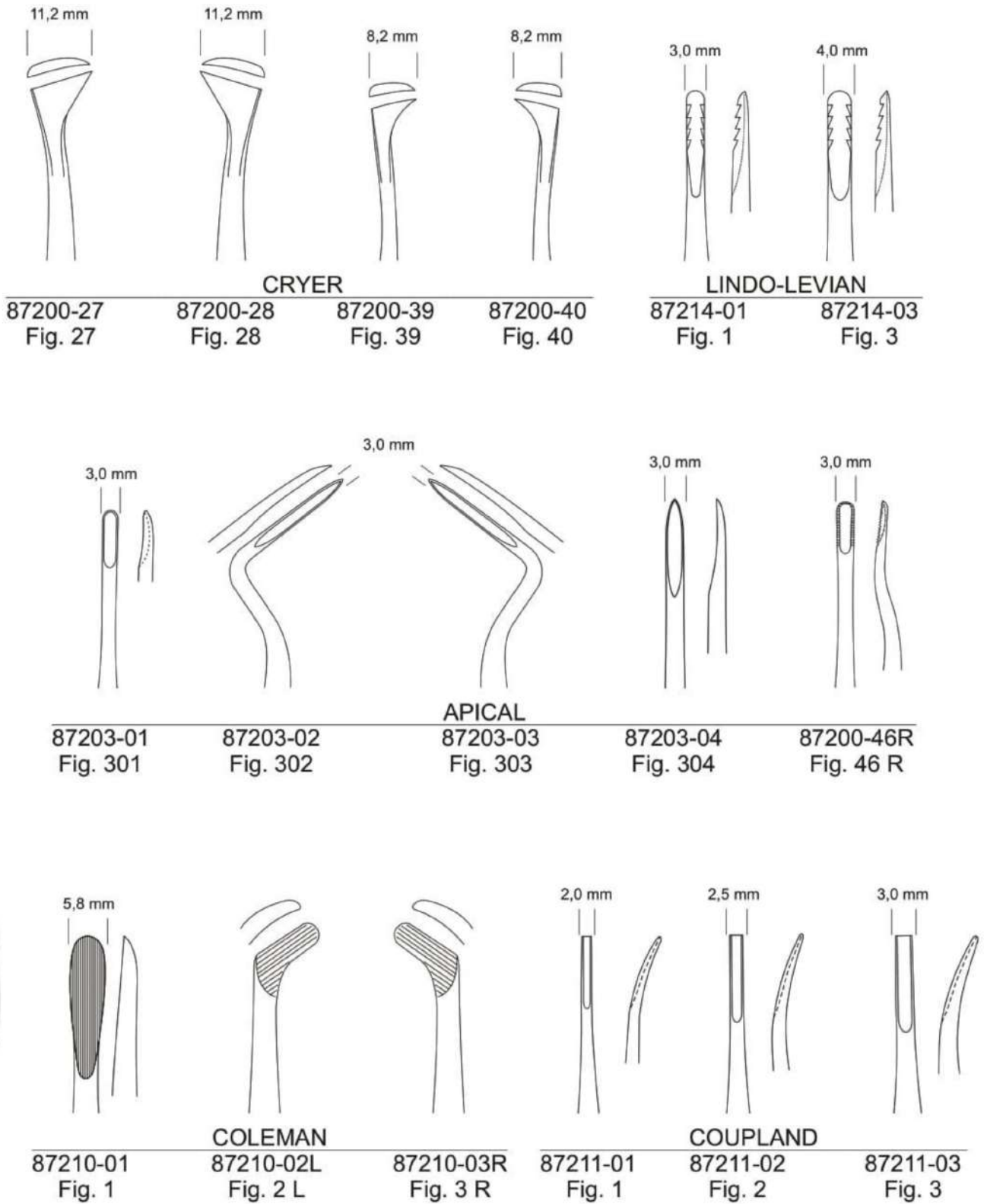

Wurzelheber
Root elevators
Elevadores para raíces
Leve per radici



FRIEDMAN
87212-01
Fig. 1



HYLIN
87213-01
Fig. 1



HYLIN
87213-02
Fig. 2

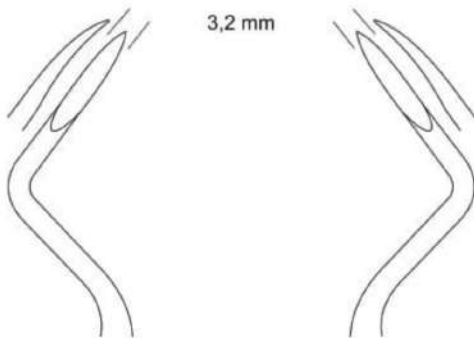

FRIEDMAN
87212-2L 87212-2R
Fig. 2 L Fig. 2 R

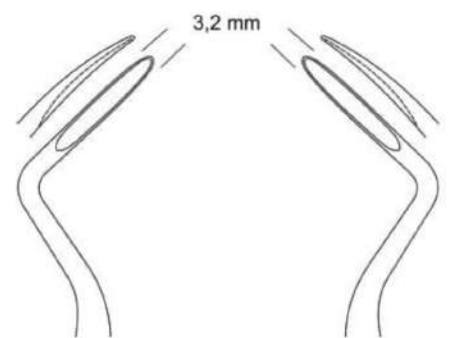

HYLIN
87213-03L 87213-03R
Fig. 3 L Fig. 4 R

Wurzelheber
Root elevators
Elevadores para raíces
Leve per radici



rund
round
redondo
rotondo

spitz
pointed
agudo
appuntito

2,0 mm

3,0 mm

4,0 mm

2,0 mm

3,0 mm

4,0 mm



BEIN

BEIN

87220-00
Fig. 0

87220-01
Fig. 1

87220-02
Fig. 2

87221-00
Fig. 0

87221-01
Fig. 1

87221-02
Fig. 2

2,0 mm

3,0 mm

4,0 mm

2,0 mm

3,0 mm

4,0 mm



BEIN

BEIN

87220-00A
Fig. 0 A

87220-01A
Fig. 1 A

87220-02A
Fig. 2 A

87221-00A
Fig. 0 A

87221-01A
Fig. 1 A

87221-02A
Fig. 2 A

2,0 mm

3,0 mm

4,0 mm



flach
flat
plat
plano

BEIN

87222-00
Fig. 0

87222-01
Fig. 1

87222-02
Fig. 2

Luxatoren
Luxators
Luxadores
Luxatori



BEIN

APICAL

87224-01
Fig. 1

87224-01A
Fig. 1 A

87226-01
Fig. 1

87226-01A
Fig. 1 A



BEIN

APICAL

87224-02
Fig. 2

87224-02A
Fig. 2 A

87226-02
Fig. 2

87226-02A
Fig. 2 A



BEIN

APICAL

87224-03
Fig. 3

87224-03A
Fig. 3 A

87226-03
Fig. 3

87226-03A
Fig. 3 A



BEIN

APICAL

87224-04
Fig. 4

87224-04A
Fig. 4 A

87226-04
Fig. 4

87226-04A
Fig. 4 A

Wurzelheber
Root elevators
Elevadores para raíces
Leve per radici



W.F. BARRY
87233-20
Fig. 320 L

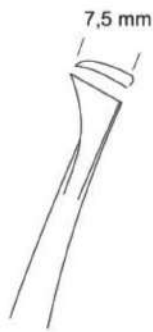

87233-21
Fig. 321 R



BARRY
87233-22
Fig. 322



87233-23
Fig. 323

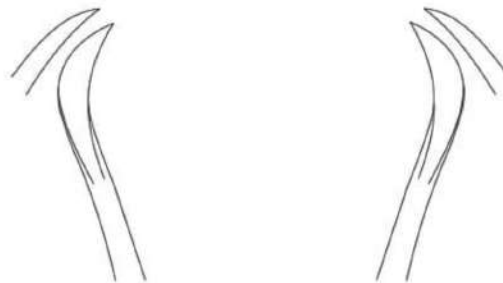

87233-70
Fig. 370 L

87233-71
Fig. 371 R



Wurzelheber
Root elevators
Elevadores para raíces
Leve per radici

9,5 mm



9,5 mm



WINTER

87230-11L
Fig. 11 L

87230-11R
Fig. 11 R

11,0 mm



11,0 mm



WINTER

87230-13L
Fig. 13 L

87230-13R
Fig. 13 R

7,0 mm

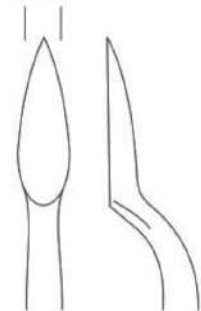

LECLUSE
87240-01
Fig. 1

WINTER

87230-14L
Fig. 14 L

87230-14R
Fig. 14 R



Wurzelheber
Root elevators
Elevadores para raíces
Leve per radici

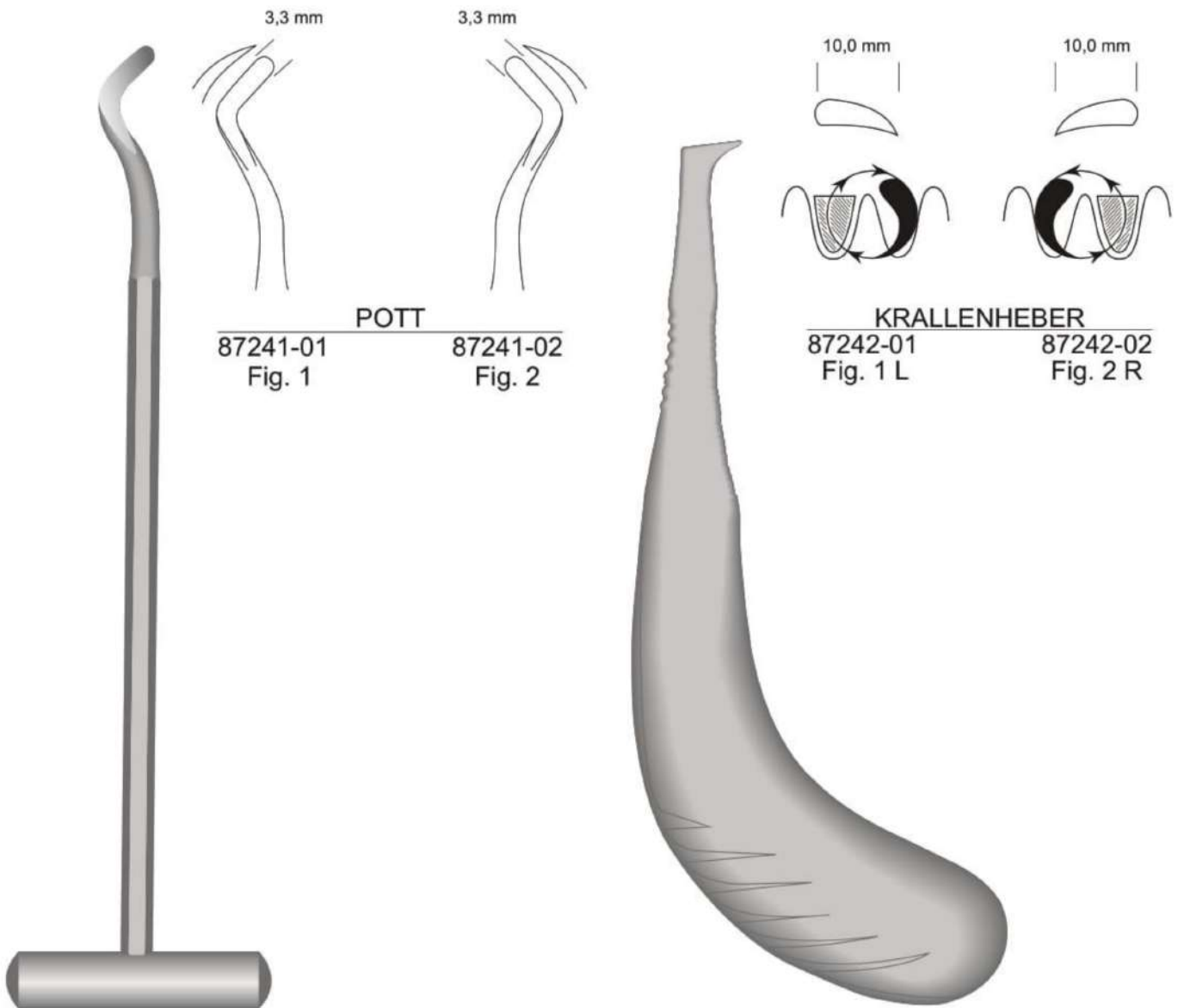

Wurzelspitzenheber
 Root fragment elevators
 Elevadores para fragmentos de raíces
 Leve per frammenti

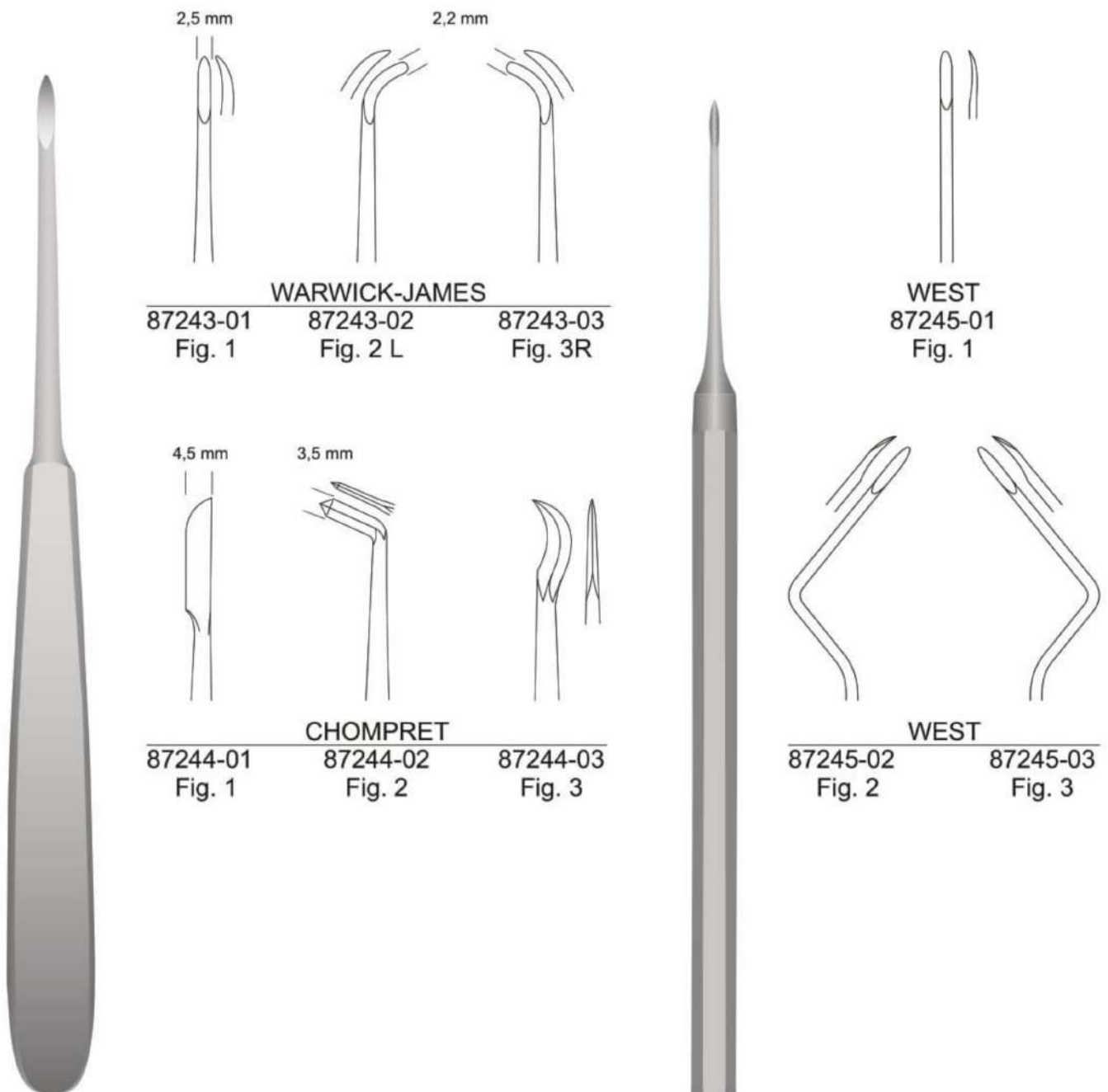

Wurzelspitzenheber
Root fragment elevators
Elevadores para fragmentos de raíces
Leve per frammenti

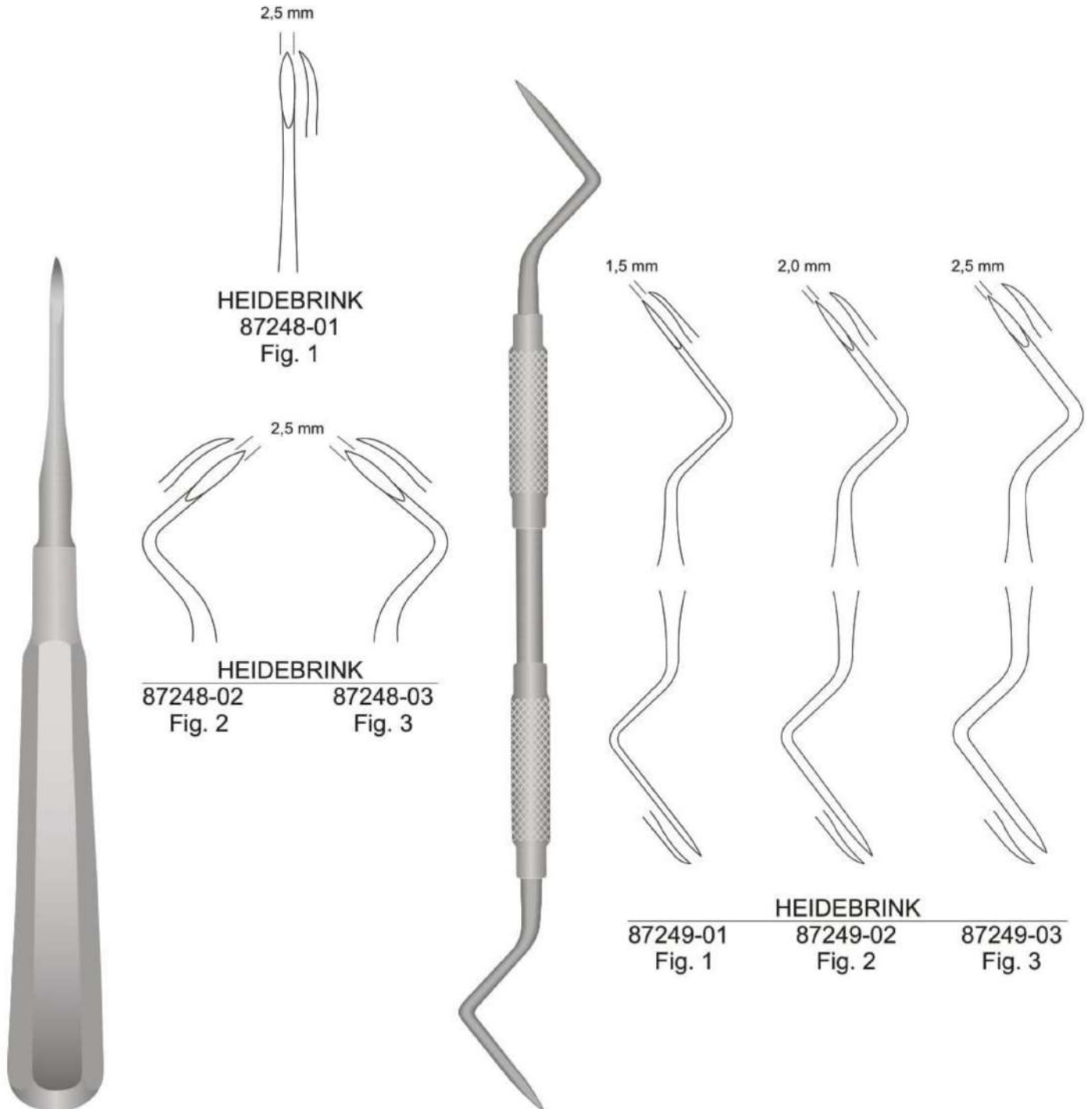

Scharfe Löffel
Bone Currettes
Cucharillas cortantes
Curette taglianti

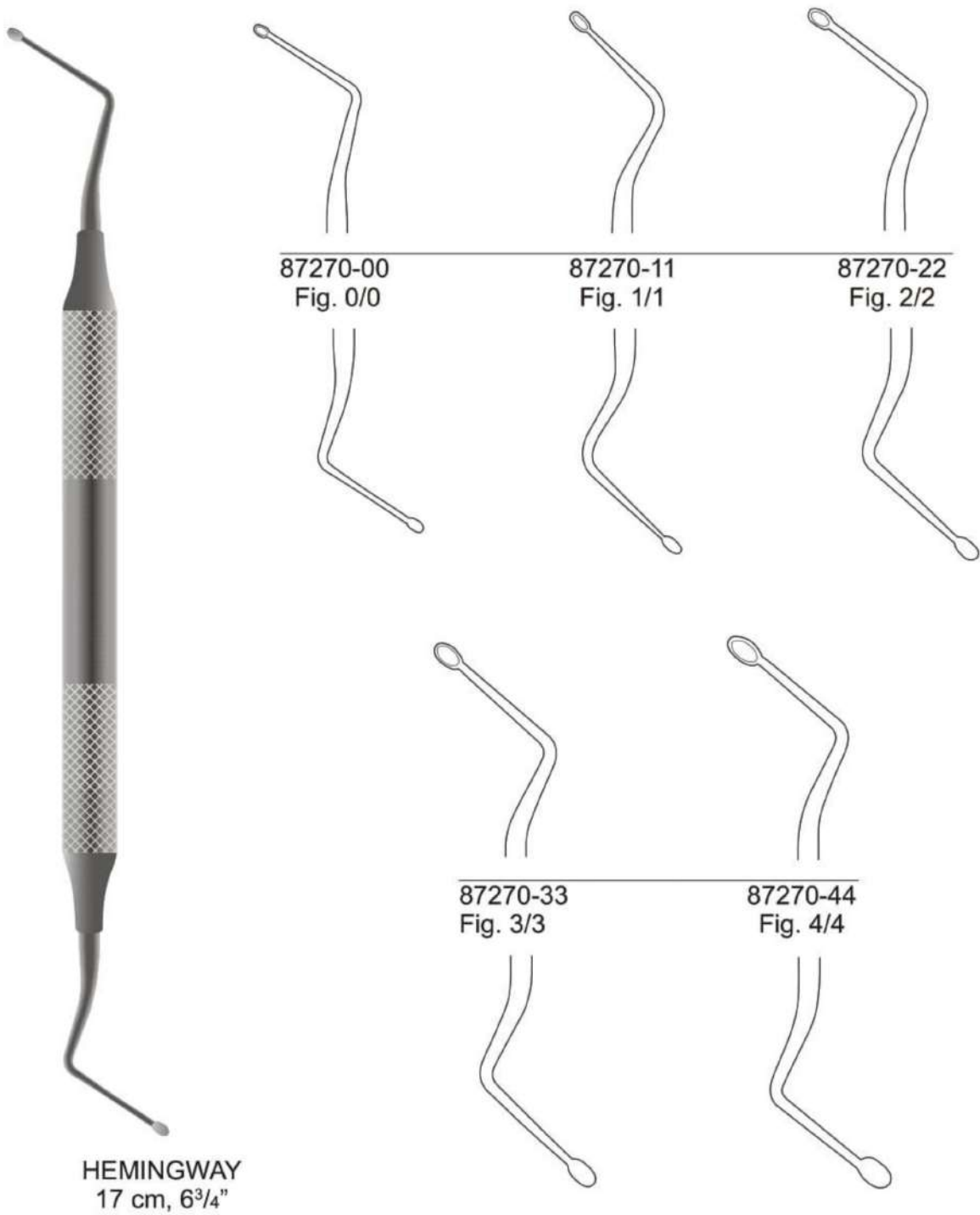

Chirurgische Küretten
Bone Currettes
Cucharillas cortantes
Curette taglianti

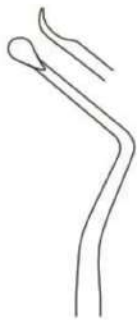

87272-00
Fig. 0/0



87272-11
Fig. 1/1



87272-22
Fig. 2/2



87272-33
Fig. 3/3

LUCAS
17,5 cm, 7"



87274-00
Fig. 0



87274-01
Fig. 1



87274-02
Fig. 2



87274-03
Fig. 3



87274-04
Fig. 4

MILLER-COLBURN
19 cm, 7³/₄"



Spritzen
Syringes
Agujas hipodérmicas
Siringhe

ohne Aspiration
without aspiration
sin aspiración
senza aspirazione



87300-18 1,8 ml
87300-22 2,2 ml

mit metrischem Gewinde
with metric thread
con rosca métrica
con filettatura metrica



87301-18 1,8 ml
87301-22 2,2 ml

mit Aspiration
with aspiration
con aspiración
con aspirazione



87302-00
10 ml

Ganzmetall-Wasserspritze
All-metal water syringe
Jeringa para agua, de metal
Siringa per acqua interamente metallica



87302-10

Kanüle LL, allein
Cannula LL, only
Cánula LL, suelta
Cannula LL, Solo

komplett mit 1 Kanüle
complete with 1 needle
completa con 1 canule
completare con 1 cannula

Injektionsspritze
Injection needle
Jeringas de inyección
Siringa di iniezione

Injektionsspritze
Injection needle
Jeringas de inyección
Siringa di iniezione



45098-01	1 ml
45098-02	2 ml
45098-05	5 ml
45098-10	10 ml
45098-20	20 ml
45098-50	50 ml

Zylinder allein
Barrel only
Cilindro suelta
Cilindro Solo



45099-01	1 ml
45099-02	2 ml
45099-05	5 ml
45099-10	10 ml
45099-20	20 ml
45099-50	50 ml

Mundspiegel
Mouth mirrors
Espejos de boca
Specchietti

plan
plane
plano
piano

hohl
concave
cóncavo
cavo



metrisches Gewinde
metric thread
rosca métrica
filettatura metrica

Fig.	mm Ø		
4	22	87310-04	87311-04
5	24	87310-05	87311-05

plan
plane
plano
piano

hohl
concave
cóncavo
cavo



Konischer-Stiel (US)
Cone socket (US)
Rosca (US) cónica
filettatura di (US) conica

Fig.	mm Ø		
4	22	87312-04	87313-04
5	24	87312-05	87313-05

Achtkant
octagonal
octagonales
ottagonale

rund
round
redondo
rotondo



metrisches Gewinde
metric thread
rosca métrica
filettatura metrica

87315-01
12 cm/4¾"

87315-02
12 cm/4¾"

87315-03
14 cm/5¼"

Konischer-Stiel (US)
Cone socket (US)
Rosca (US) cónica
filettatura di (US) conica

87315-11
12 cm/4¾"

87315-12
12 cm/4¾"

87315-13
14 cm/5¼"

Kehlkopfspiegel
Laryngeal Mirrors
Espejos laringeos
Specchi laringei



	Fig.	mm Ø	
53270-08	00	8	53272-08
53270-10	0	10	53272-10
53270-12	1	12	53272-12
53270-14	2	14	53272-14
53270-16	3	16	53272-16
53270-18	4	18	53272-18
53270-20	5	20	53272-20
53270-22	6	22	53272-22
53270-24	7	24	53272-24
53270-26	8	26	53272-26
53270-28	9	28	53272-28
53270-30	10	30	53272-30



53272-08 - 53270-30



53272-08 - 53272-30

Scaler, supragingivaler Einsatz
 Scalers, supragingival
 Limpiadores de sarro
 Ablatori di tartaro, supragingival



15,5 cm, 6¼"

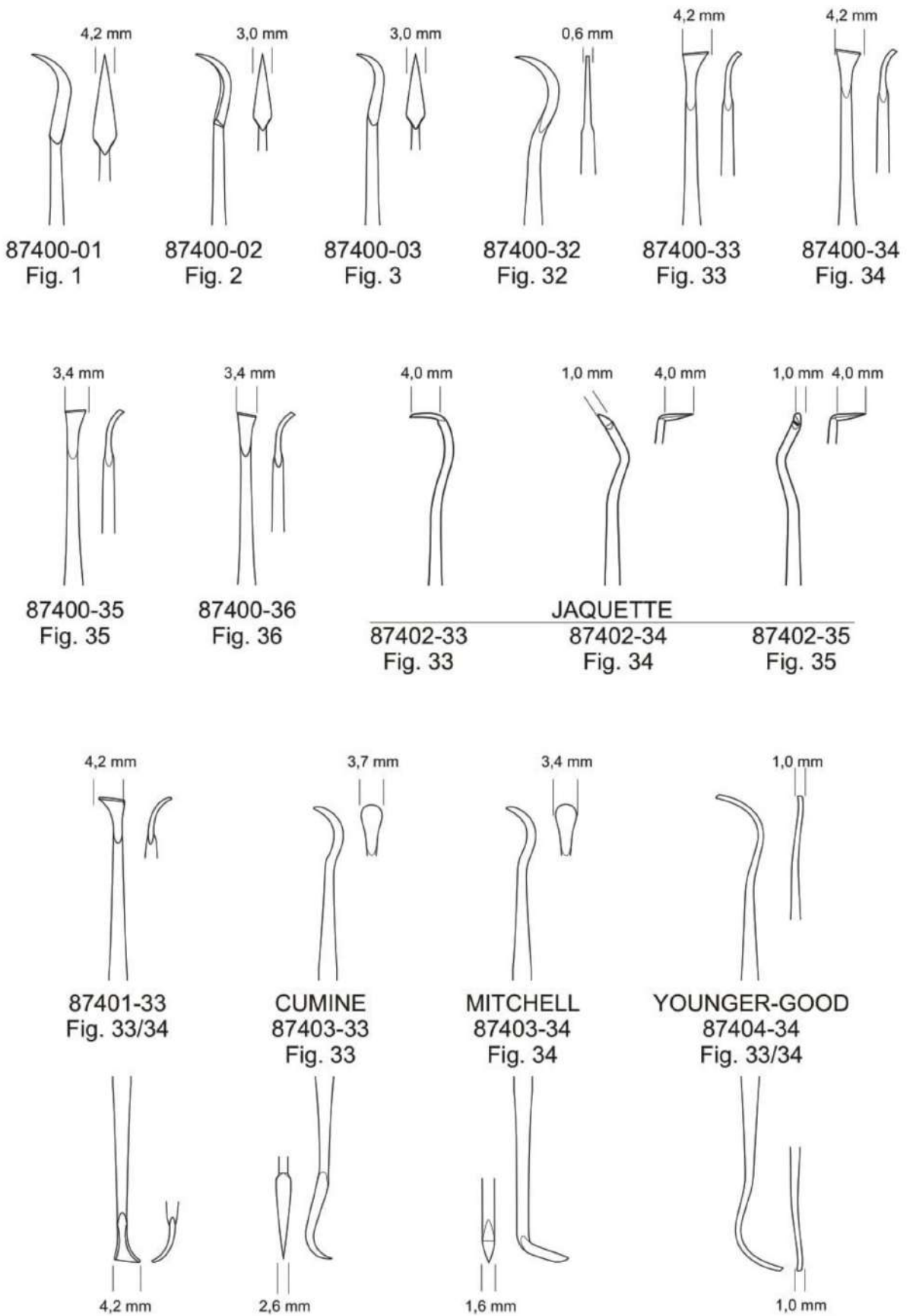

Scaler, supragingivaler Einsatz
 Scalers, supragingival
 Limpiadores de sarro
 Ablatori di tartaro, supragingival

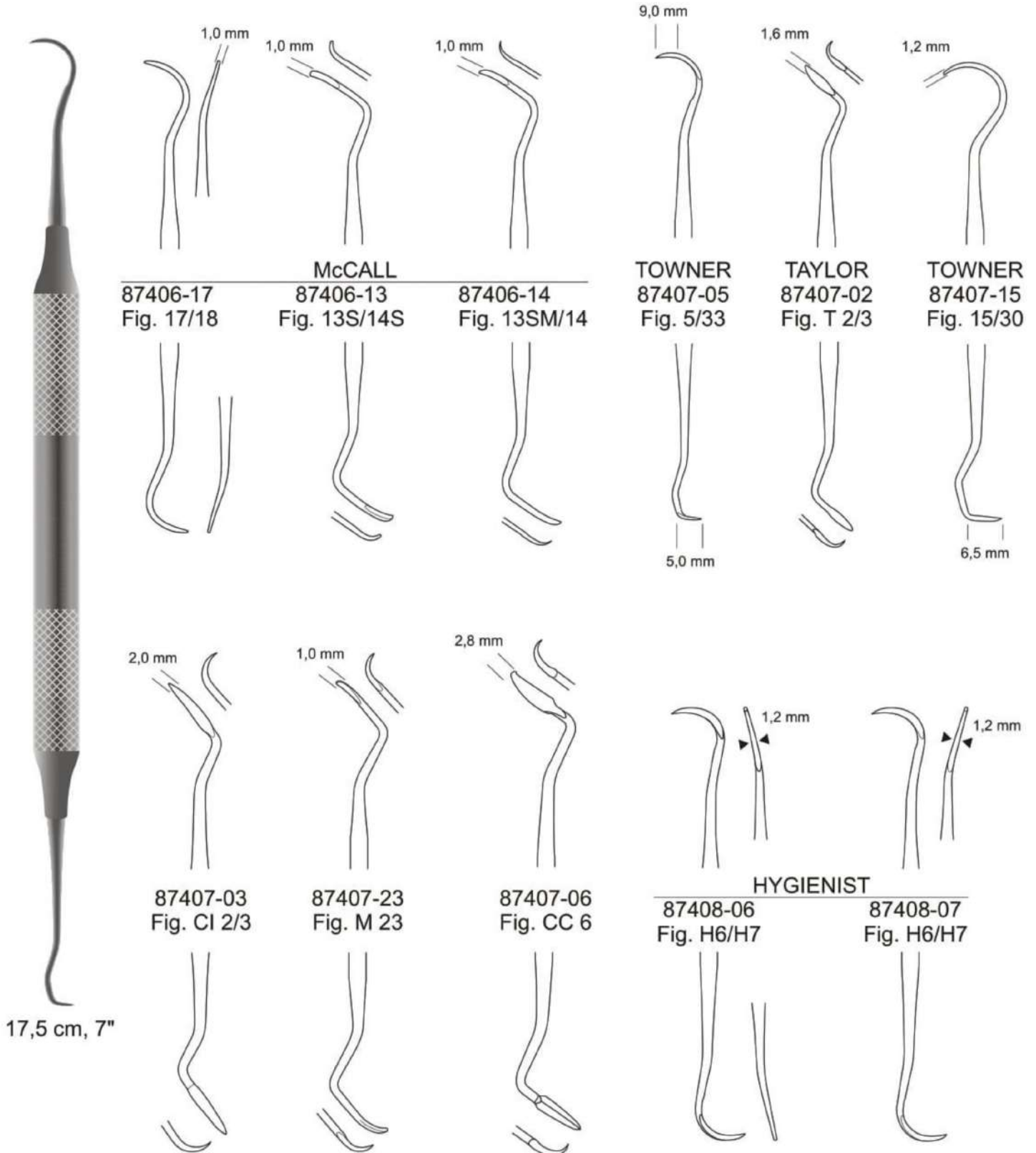

Scaler, supragingivaler Einsatz
 Scalers, supragingival
 Limpiadores de sarro
 Ablatori di tartaro, supragingival



17,5 cm, 7"



87411-35
Fig. U 135



87412-04
Fig. 204



87412-04S
Fig. 204 S



87412-04SD
Fig. 204 SD

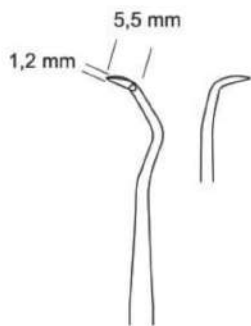

87414-32
Fig. 31/32

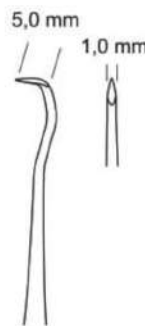

JAQUETTE

87414-33
Fig. 30/33

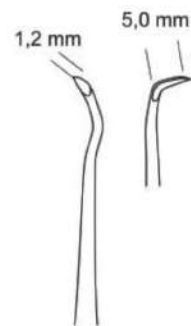

87414-35
Fig. 34/35



Scaler, supragingivaler Einsatz
 Scalers, supragingival
 Limpiadores de sarro
 Ablatori di tartaro, supragingival

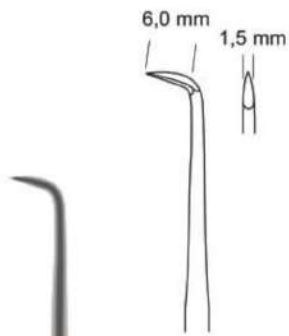

87416-01
Fig. 1

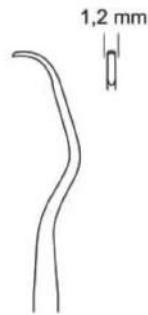

87416-02
Fig. 2



87416-03
Fig. 3



87416-04
Fig. 4



87416-05
Fig. 5

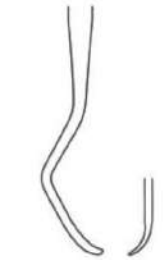

87416-06
Fig. 6



GOLDMAN-FOX
17,5 cm, 7"

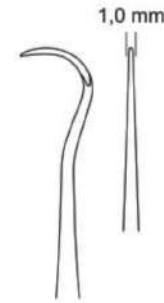

MERCITAN
87418-05
Fig. SH 5

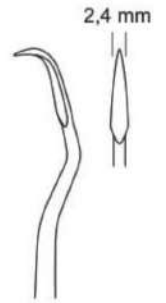

WARD-KIRKLAND
87418-01
Fig. 1



CRANE-KAPLAN
87418-02
Fig. 2



CRANE-KAPLAN
87418-03
Fig. 3



WHITE
87418-12B
Fig. 12B



17,5 cm, 7"

Gingivektomiemesser
 Gingivectomy knives
 Bisturíes para la gingivectomía
 Bisturie per gengivectomia



17,5 cm, 7"

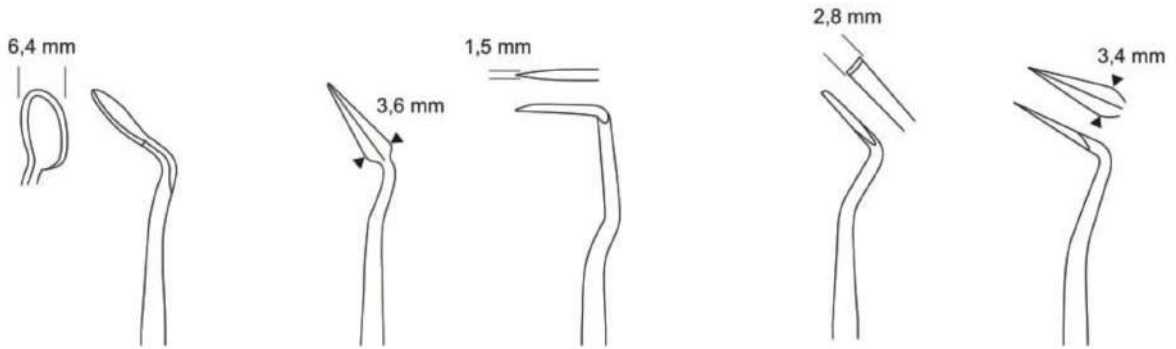

GOLDMAN-FOX

87420-07 Fig. 7 87420-08 Fig. 8 87420-09 Fig. 9 87420-10 Fig. 10 87420-11 Fig. 11

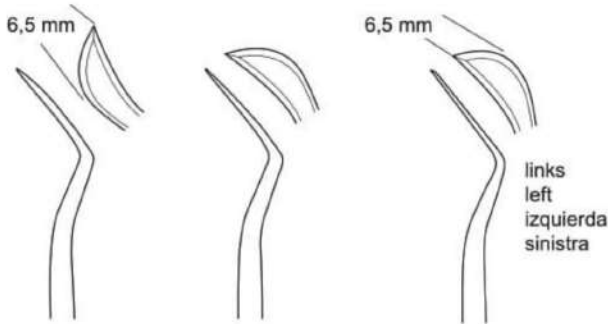

KIRKLAND
 87421-01L 87421-02R

links
 left
 izquierda
 sinistra

rechts
 right
 derecha
 destra

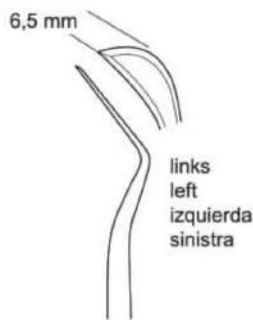

KIRKLAND
 87421-12

rechts
 right
 derecha
 destra

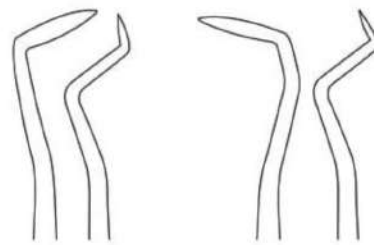

ORBAN
 87422-01 Fig. 1 87422-02 Fig. 2

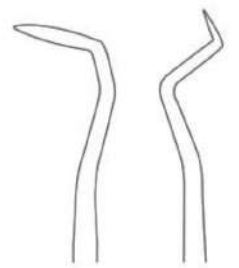

ORBAN
 87422-12B
 Fig. 1/2

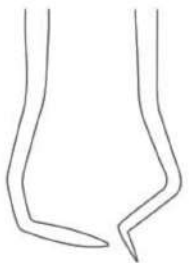

Meißel, Parodontalmeißel
Chisels, Periodontal chisels
Cinceles, Cinceles de periodoncia
ScalPELLi, Sgorbie per parodontologia

aufwärts gebogen
curved upwards
curvos hacia arriba
curvo verso l'alto

abwärts gebogen
curved downwards
curvos hacia abajo
curvo verso il basso



OGHSENBEIN
87425-01 Fig. 1 87425-02 Fig. 2



17,5 cm, 7"

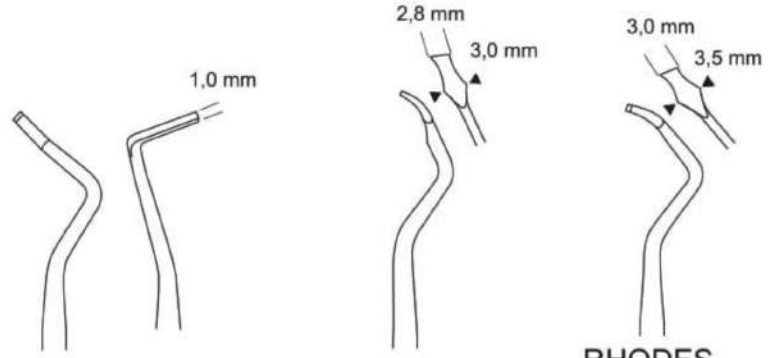

OGHSENBEIN
87425-03 Fig. 3 87425-04 Fig. 4 RHODES 87425-36 Fig. 36/37

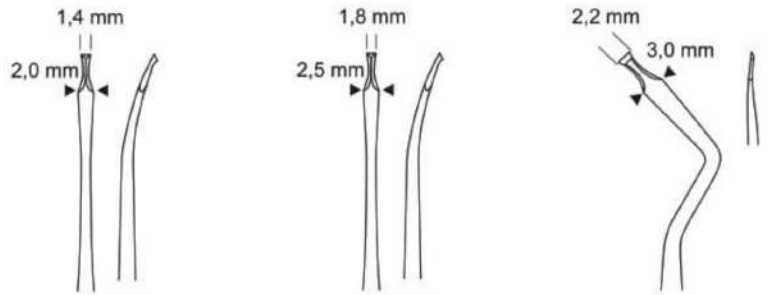
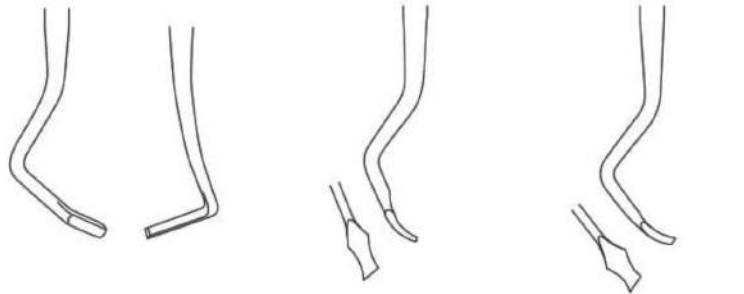

FEDI
87426-01 Fig. 1 87426-02 Fig. 2 87426-03 Fig. 3



Meißel, Knochenfeilen, Parodontalfeile
 Chisels, Bone files, Periodontal file
 Cinceles, Limas de hueso, Lima parodontal
 Scalpelli, Lime e raspe per osso, Lima periodontale

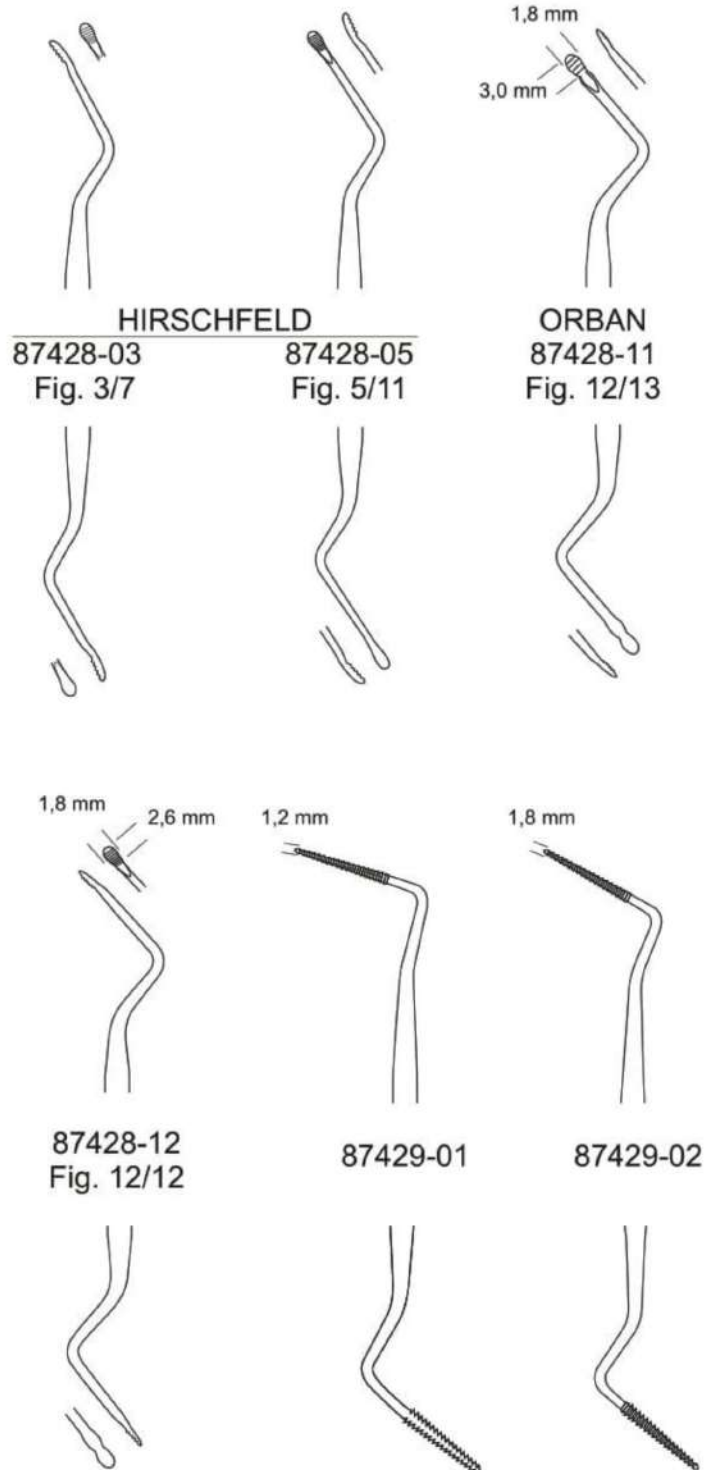

4 mm	87427-04	87427-14
7,5 mm	87427-08	87427-18
gerade		gebogen
straight		curved
recta		curva
diritto		arcuato

Küretten, subgingivaler Einsatz
 Curettes, subgingival
 Curetas, subgingival
 Curette, subgingivale

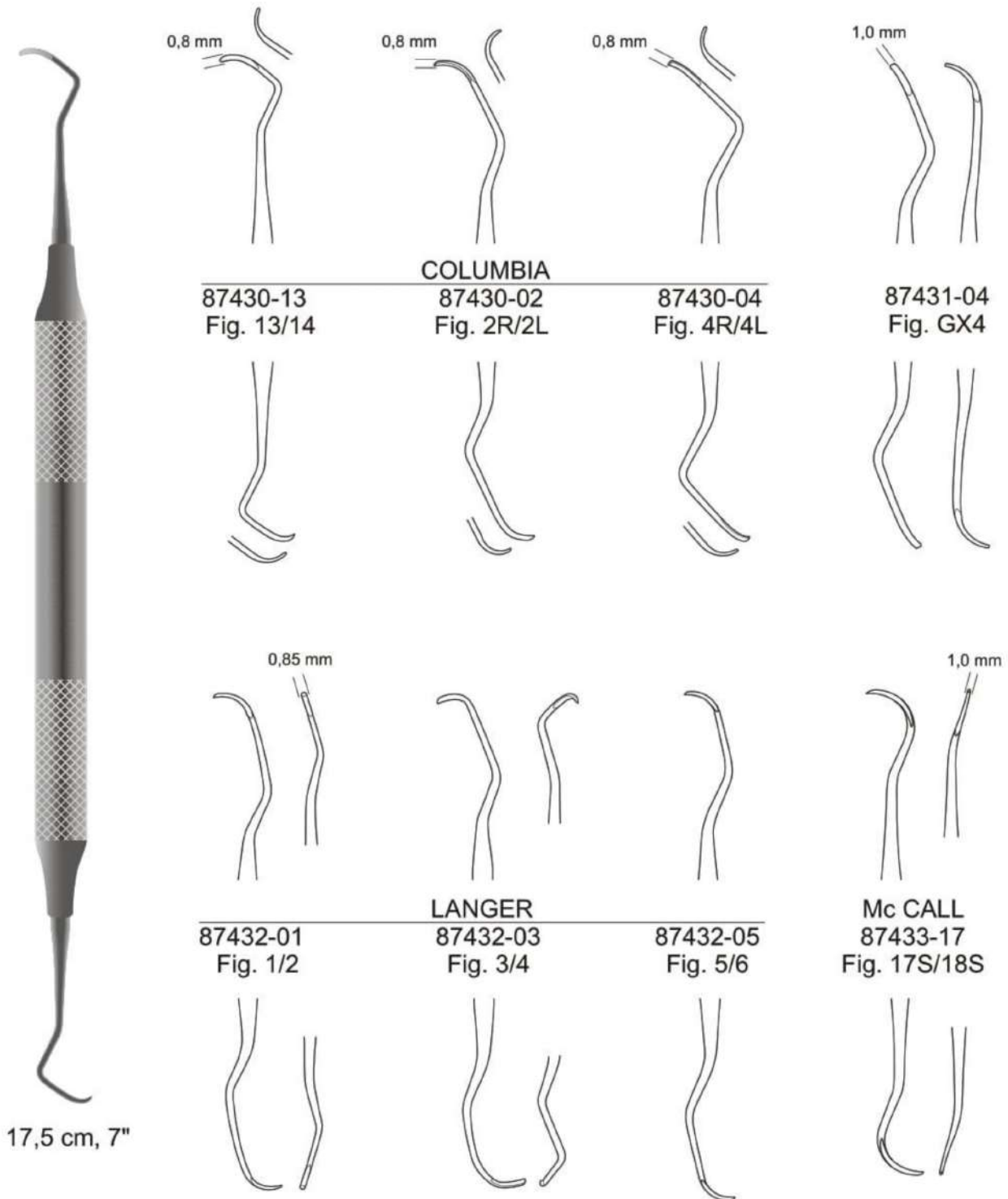

Küretten, subgingivaler Einsatz
 Curettes, subgingival
 Curetas, subgingival
 Curette, subgingivale

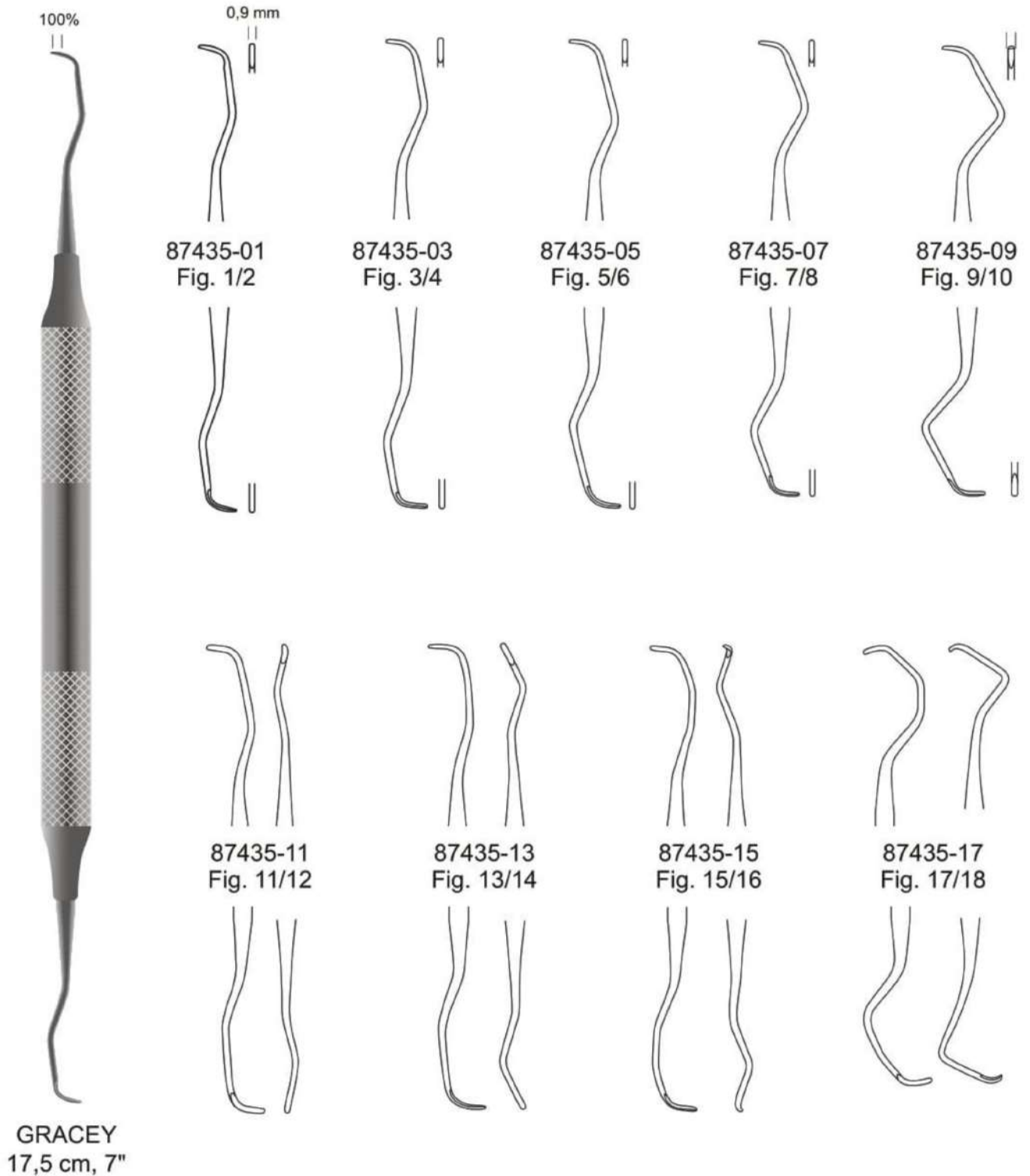

Küretten, subgingivaler Einsatz
 Curettes, subgingival
 Curetas, subgingival
 Curette, subgingivale

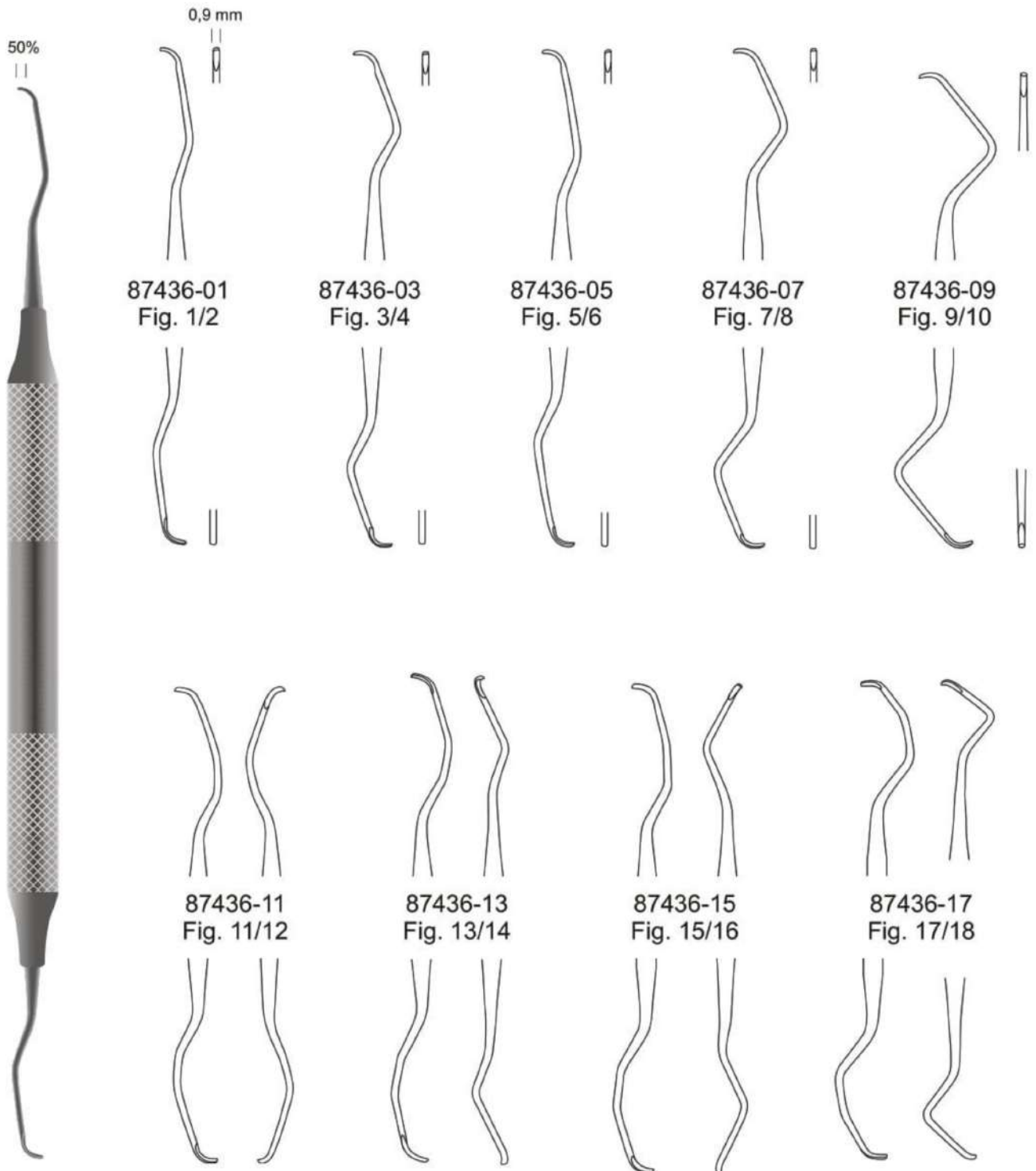

GRACEY (MINI)
 17,5 cm, 7"

Küretten, subgingivaler Einsatz
 Curettes, subgingival
 Curetas, subgingival
 Curette, subgingivale

100%

1,1 mm



87437-01
 Fig. 1/2



87437-03
 Fig. 3/4



87437-05
 Fig. 5/6



87437-07
 Fig. 7/8



87437-09
 Fig. 9/10

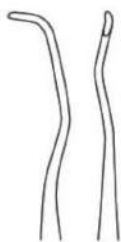

87437-11
 Fig. 11/12



87437-13
 Fig. 13/14

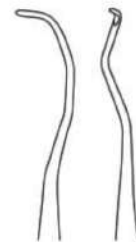

87437-15
 Fig. 15/16

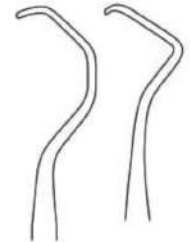

87437-17
 Fig. 17/18



GRACEY (RIGID)
 17,5 cm, 7"

Furkationskürette, Furkationssonde
 Furcation curette, Furcation probe
 Cureta de furcación, Sonda de furcación
 Curetta di forcazione, Sonda di forcazione

Furkationskürette
 Furcation curette
 Cureta de furcación
 Curetta di forcazione

1,2 mm



87439-01
 Fig. 1
 0,9 mm



87439-02
 Fig. 2
 3 mm

1,0 mm



87439-03
 Fig. 3
 0,9 mm



1,6 mm

87439-04
 Fig. 4
 1,3 mm



2,1 mm

87439-05
 Fig. 5
 0,9 mm



1,0 mm

PRICHARD
 87439-12
 Fig. 1/2

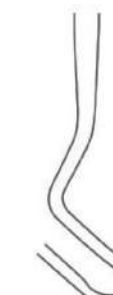

0,5 mm



Furkationssonde, graduiertes
 Furcation probe, graduated
 Sonda de furcación, graduada
 Sonda di forcazione, graduata



NABERS
 87439-40
 17,5 cm, 7"

17,5 cm/7"

Parodontometer
 Periodontal probes
 Sondas parodontales
 Sonde parodontali

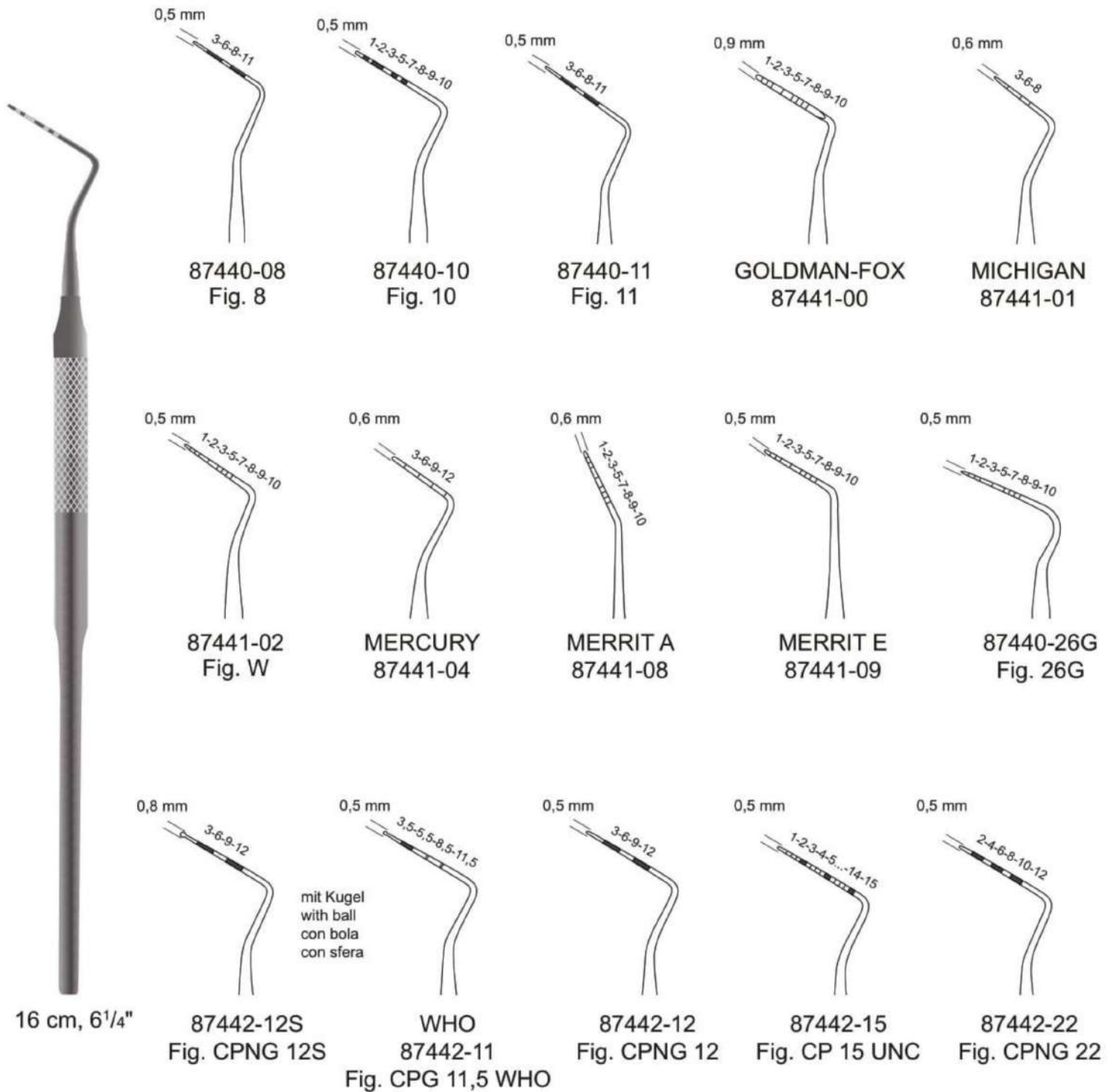

Parodontometer, Zahnsonden
 Periodontal probes, Explorers
 Sondas parodontales, Sondas
 Sonde parodontali, Sonde

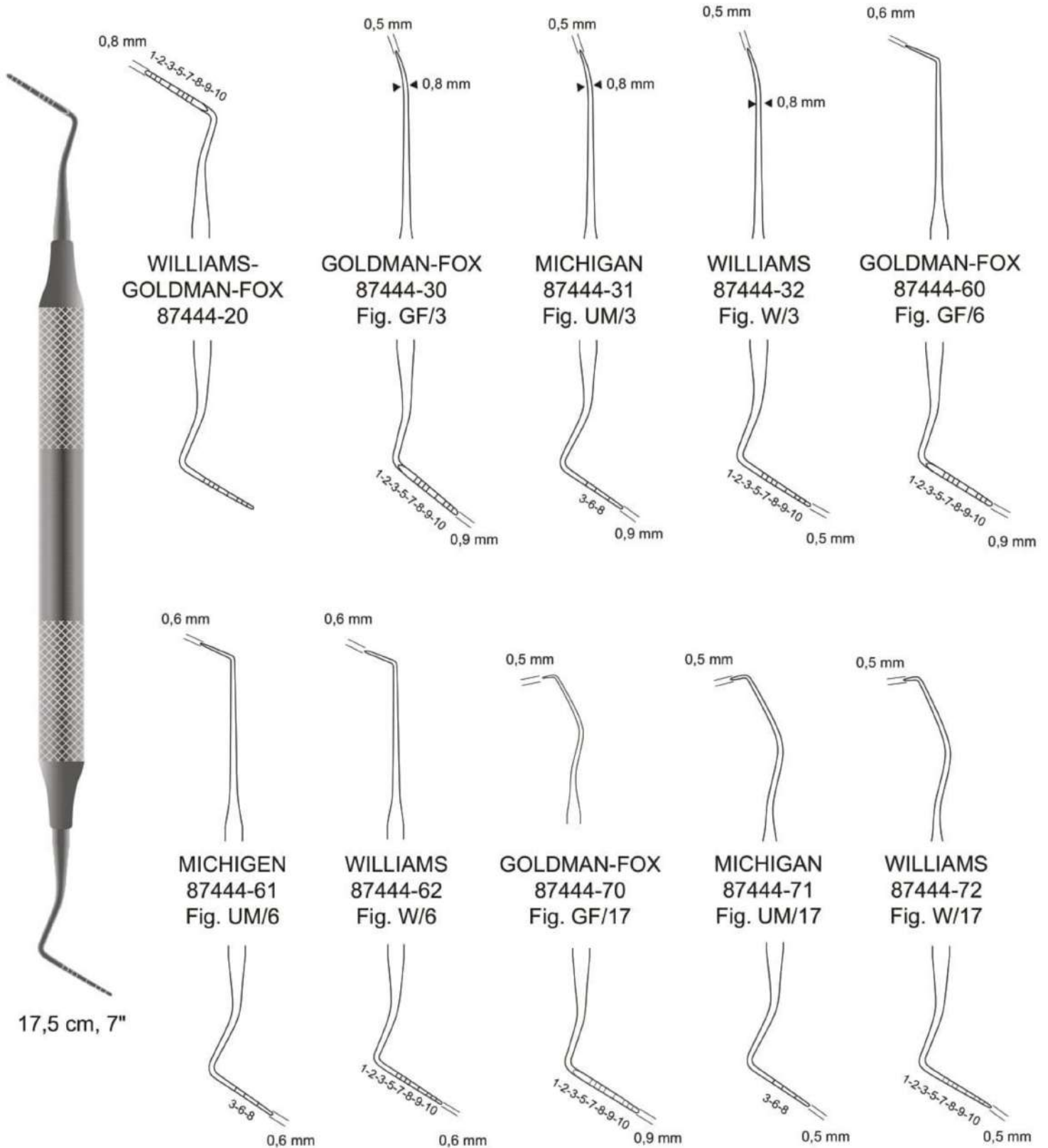

Parodontometer, Zahnsonden
 Periodontal probes, Explorers
 Sondas parodontales, Sondas
 Sonde parodontali, Sonde

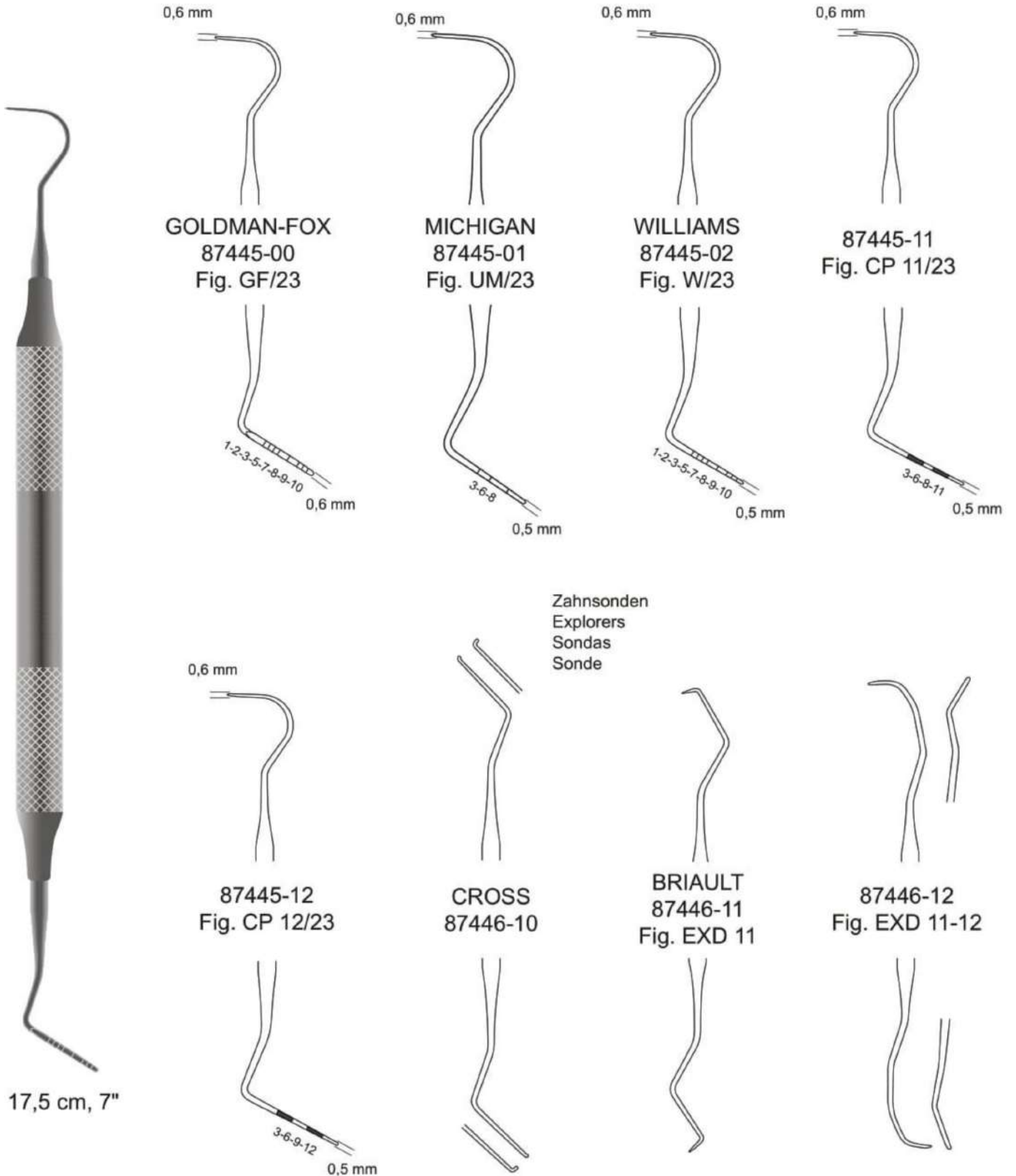



















Zahnsonden
Explorers
Sondas
Sonda

extra feine Zahnsonde
extra delicate tooth probe
sonda dental extradelicada
sonda dentale superfine

0,5 mm



17,5 cm, 7"

				
87450-03 Fig. 3	87450-03A Fig. 3 A	87450-06 Fig. 6	87450-06XL Fig. 6 XL	87450-08A Fig. 8 A
				
87450-09 Fig. 9	87450-12 Fig. 12	87450-17 Fig. 17	87450-23 Fig. 23	
0,6 mm				
				
87451-03 Fig. 3	87451-03A Fig. 3 A	87451-06 Fig. 6	87451-06XL Fig. 6 XL	87451-08A Fig. 8 A
				
87451-09 Fig. 9	87451-12 Fig. 12	WHITE 87451-17 Fig. 17	87451-23 Fig. 23	87451-54 Fig. 54

Zahnsonden
Explorers
Sondas
Sonde

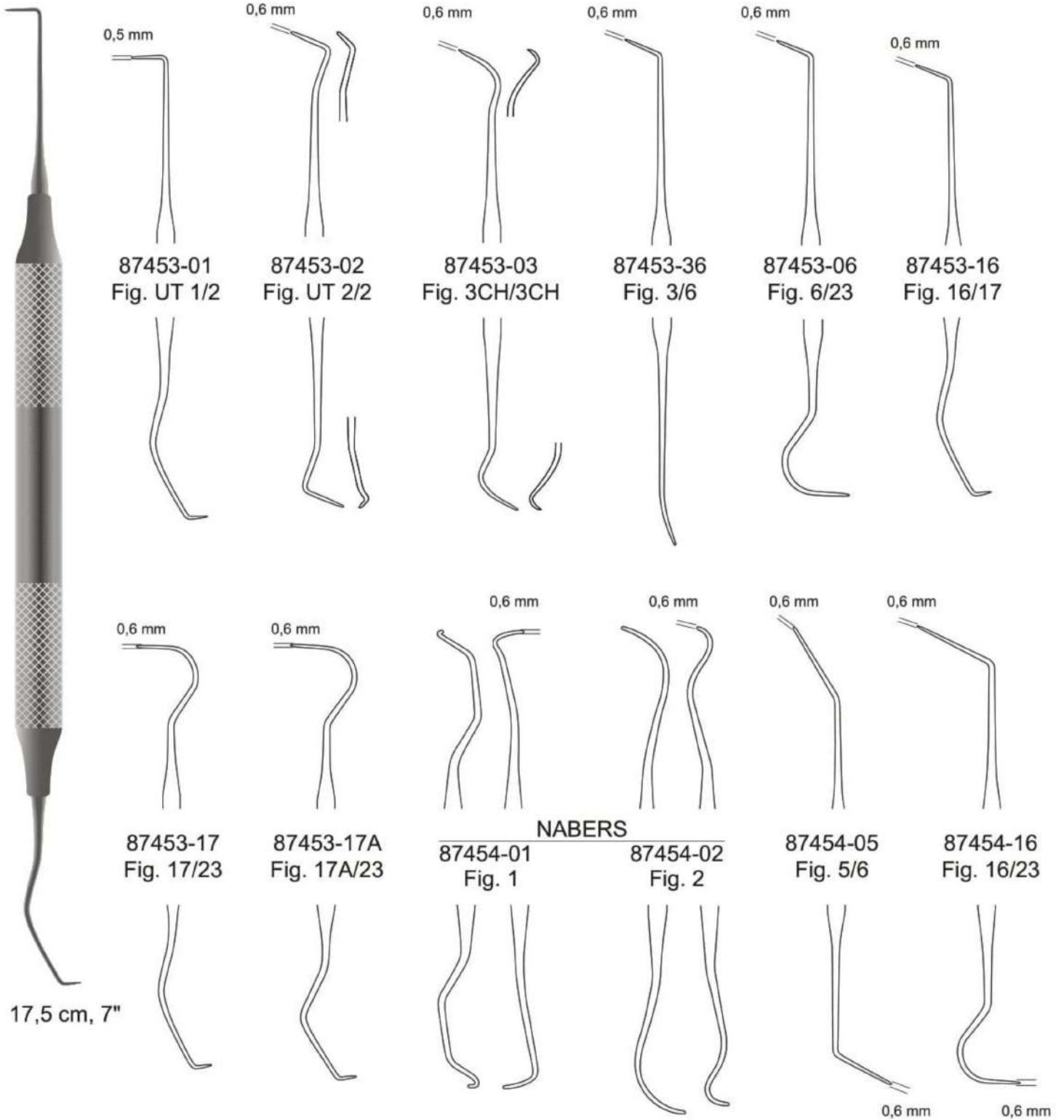

Exkavatoren
Excavators
Excavadores
Escavatori

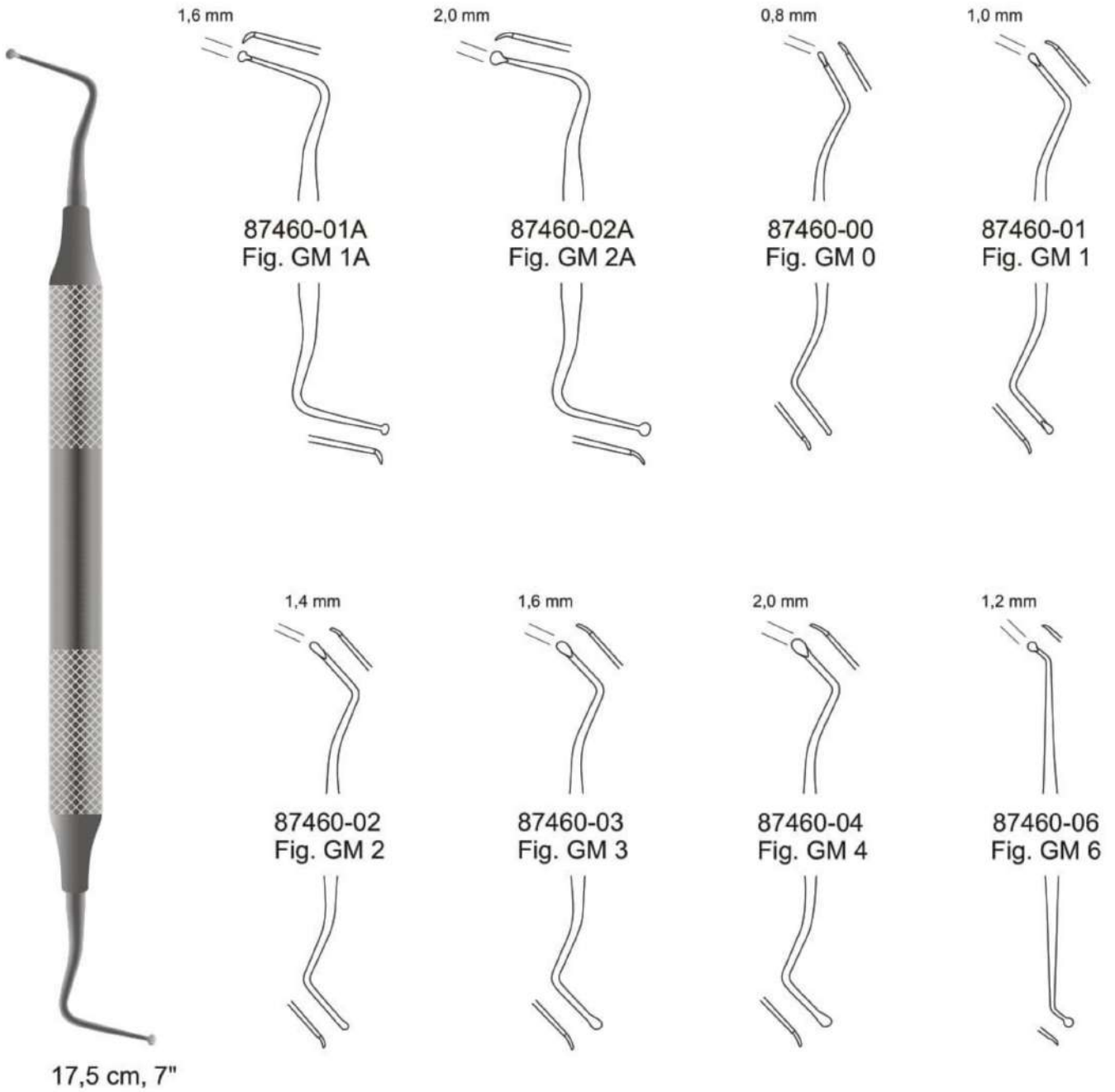

Exkavatoren
Excavators
Excavadores
Escavatori

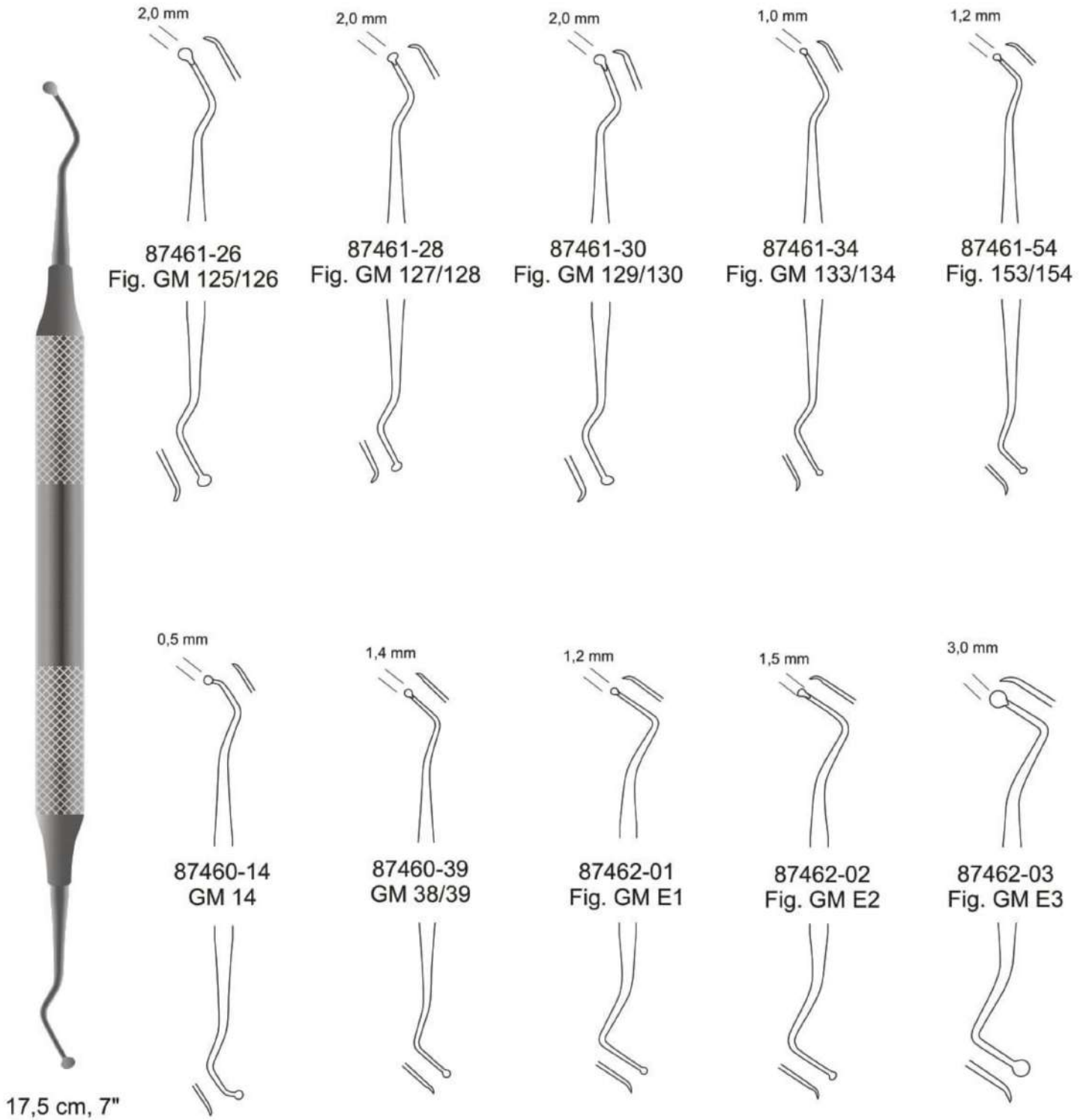

Exkavatoren
Excavators
Excavadores
Escavatori

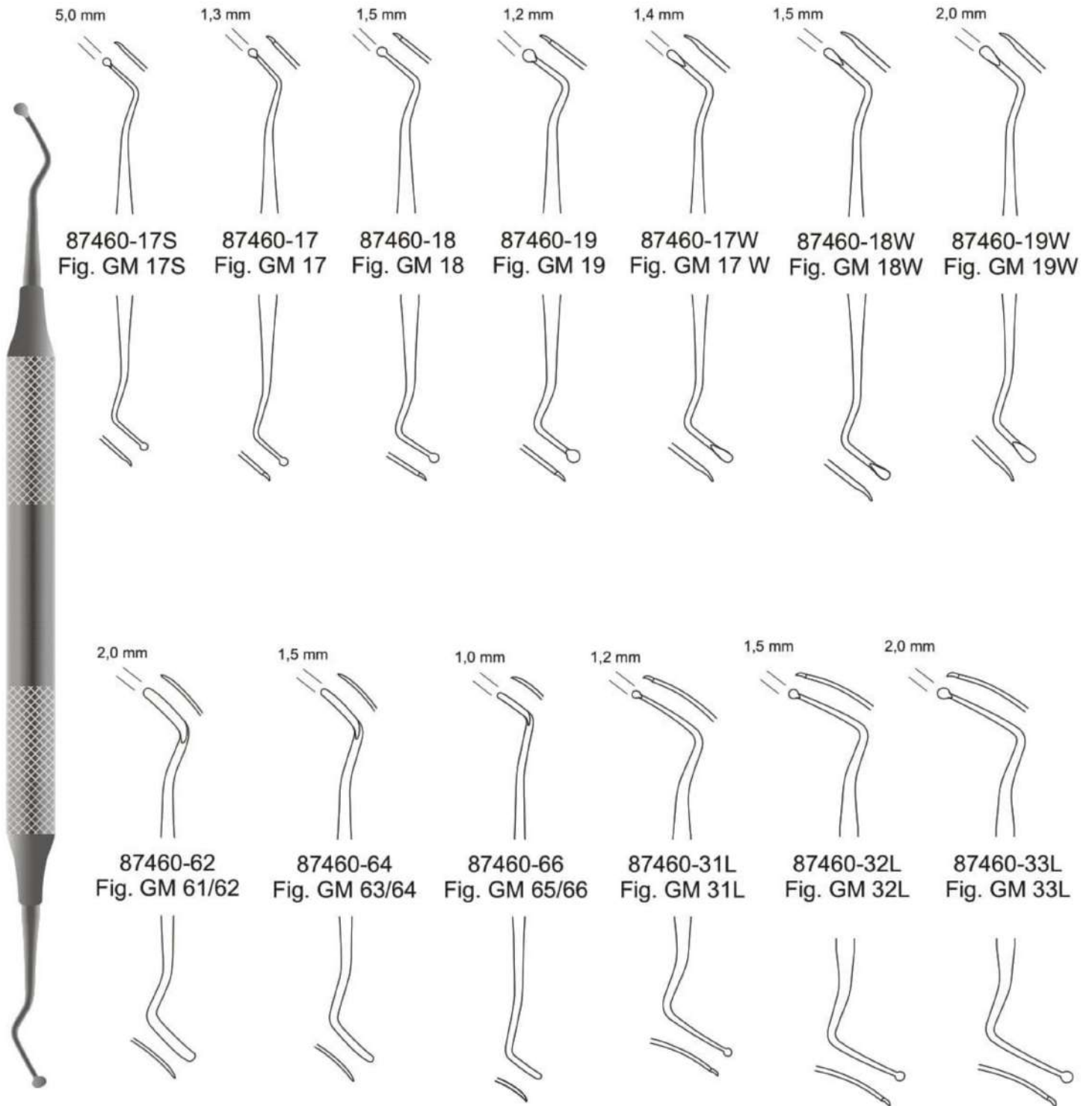

17,5 cm, 7"

Schmelzmeißel
Enamel chisels
Cinceles para esmalte
Tagliasmalto

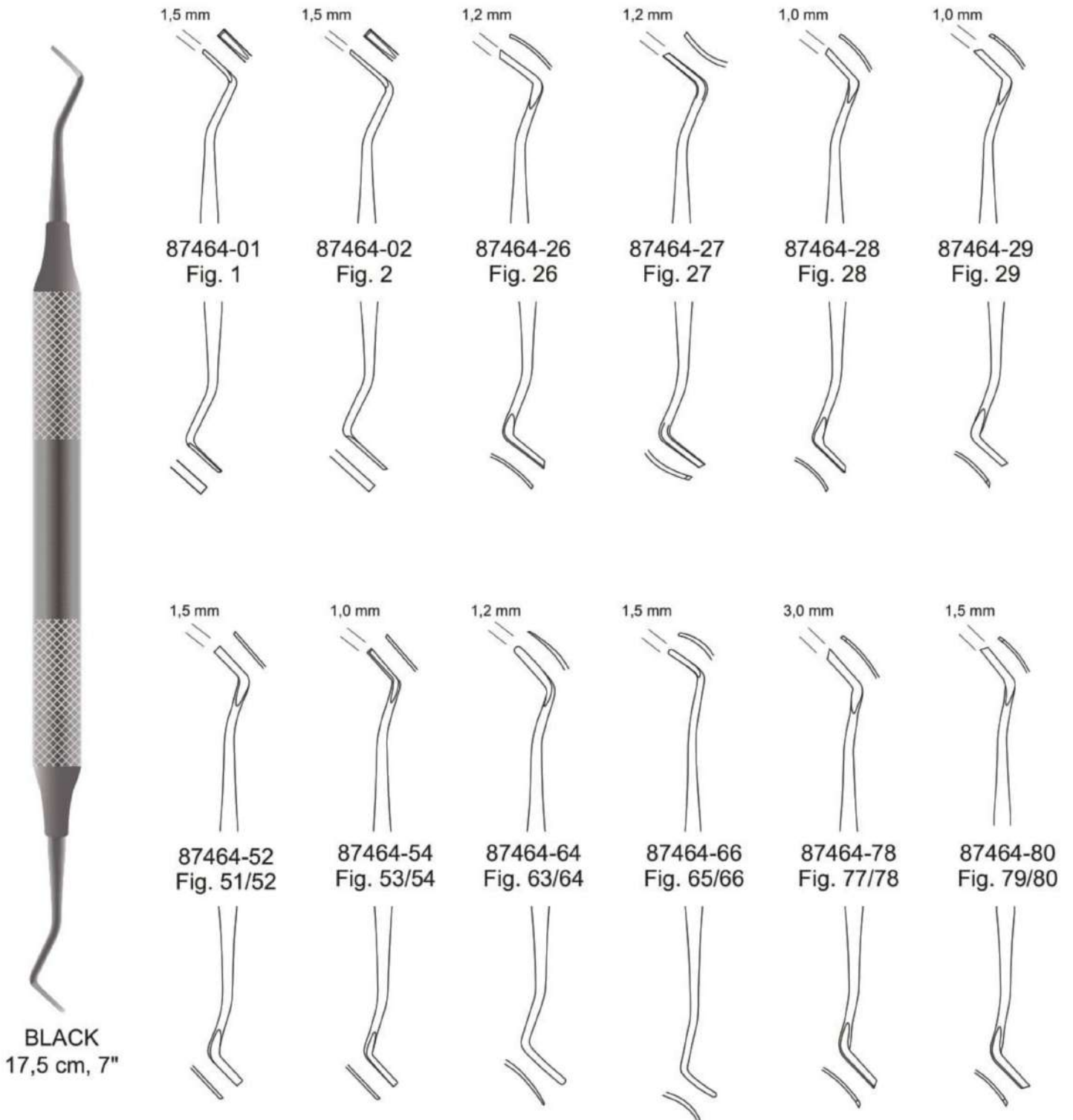

Nervkanal-Instrumente
Root canal instruments
Instrumentos para canales
Strumenti per trattamenti canalari

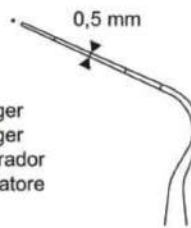
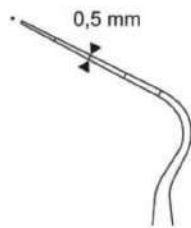
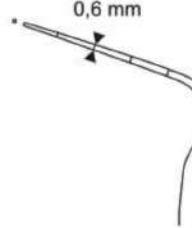
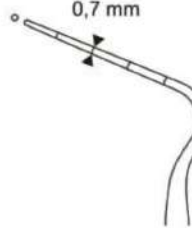
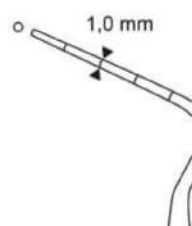
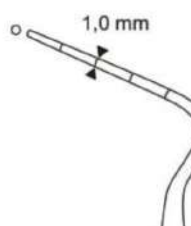
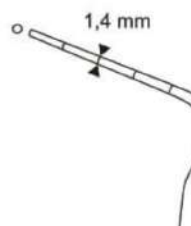
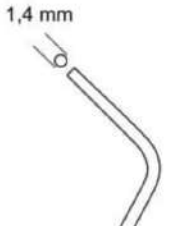
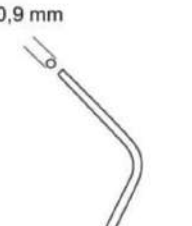
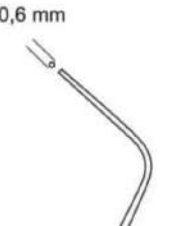
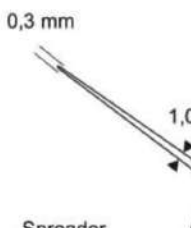
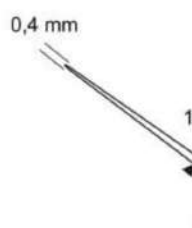
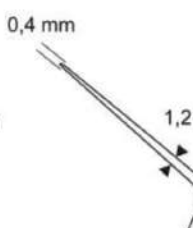
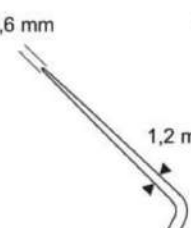
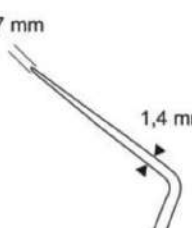

17,5 cm, 7"

Plugger Plugger Obturador Otturatore	 <p>0,5 mm</p> <p>87470-30 Fig. 30</p>	 <p>0,5 mm</p> <p>87470-40 Fig. 40</p>	 <p>0,6 mm</p> <p>87470-50 Fig. 50</p>	 <p>0,7 mm</p> <p>87470-60 Fig. 60</p>	
	 <p>1,0 mm</p> <p>87470-90 Fig. 90</p>	 <p>1,0 mm</p> <p>87471-00 Fig. 100</p>	 <p>1,4 mm</p> <p>87471-20 Fig. 120</p>		
	 <p>1,4 mm</p> <p>87472-01 Fig. 1</p>	 <p>0,9 mm</p> <p>87472-02 Fig. 2</p>	 <p>0,6 mm</p> <p>87472-03 Fig. 3</p>		
	 <p>0,3 mm</p> <p>1,0 mm</p> <p>87472-20 Fig. 20</p>	 <p>0,4 mm</p> <p>1,0 mm</p> <p>87472-30 Fig. 30</p>	 <p>0,4 mm</p> <p>1,2 mm</p> <p>87472-40 Fig. 40</p>	 <p>0,6 mm</p> <p>1,2 mm</p> <p>87472-50 Fig. 50</p>	 <p>0,7 mm</p> <p>1,4 mm</p> <p>87472-60 Fig. 60</p>
Spreader Spreader Extensor Estensore					

Kompositinstrument
Composite instrument
Instrumento compuesto
Strumento composto

Amalgam-Fingerbecher
 Amalgam finger bowl
 Vaso para dedos de amalgama
 Vaso di amalgama



87500-51

Boden flach
 bottom flat
 base plana
 base piana



87500-52

Boden rund
 bottom round
 base redonda
 base tonda



Amalgampistole
 Amalgam carrier
 Porta amalgamas
 Cucchiaino portamalgame

leicht gebogen
 slightly curved
 ligeramente curvo
 leggermente curvo

87500-01



gewinkelt
 angled
 acodado
 angolato

87500-02

Kunststoffansatz allein
 Plastic tip alone
 Sólo aditamento de plástico
 Accessorio in plastica



87500-09



17,5 cm, 7"



87501-09
 Fig. GM 9/10



87501-29
 Fig. 29/2B



87501-11
 Fig. GM 11/12



87502-01
 Fig. L1



87501-00
 Fig. GM SB



































87502-02
 Fig. L2



Kompositinstrument
Composite instrument
Instrumento compuesto
Strumento composto



17.5 cm/7"

						FELT	
							
87503-01 Fig. 1	87503-02 Fig. 2	87503-03 Fig. 3	87503-04 Fig. 4	87503-05 Fig. 5	87503-10 Fig. 10	87504-01 Fig. 1	87504-02 Fig. 2
							
							
FELT				GOLDSTEIN			
87504-03 Fig. 3	87504-04 Fig. 4	87504-05 Fig. 5	87504-06 Fig. 6	87505-01 Fig. 1	87505-02 Fig. 2	87505-03 Fig. 3	87505-04 Fig. 4
							

Füllungsinstrumente
 Filling instruments
 Instrumentos para obturaciones
 Otturatori

Elefantfußstopfer
 Elephant foot condenser
 Obturateur pied d'éléphant
 Otturatore a piede di elefante

Polierinstrument
 Polisher
 Instrumento para pulir
 Lucidatore

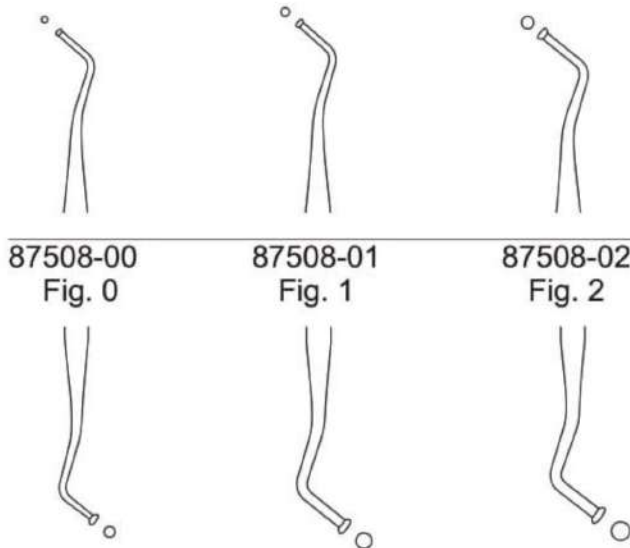

87508-00
Fig. 0

87508-01
Fig. 1

87508-02
Fig. 2

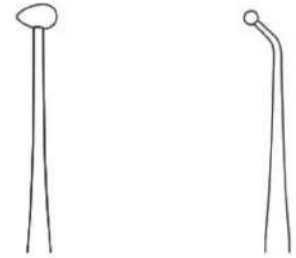

87509-28
Fig. 28/29

87509-27
Fig. 27/29

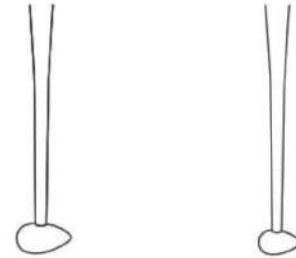

Kugelstopfer
 Ball type condenser
 Condensador tipo bola
 Otturatore a sfera

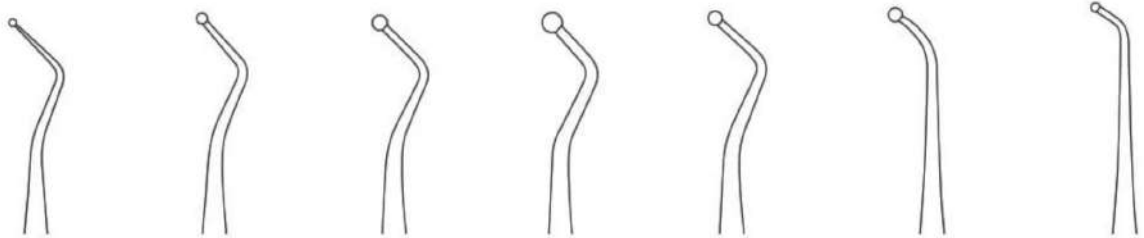

BALL

87510-01
Fig. 1

87510-02
Fig. 2

87510-03
Fig. 3

87510-04
Fig. 4

87510-05
Fig. 5

87510-18
Fig. 18

87510-26
Fig. 26/27S



Planstopfer
Plane condenser
Condensador plano
Otturatore piano

gerieft
fluted
acanalado
scanalato

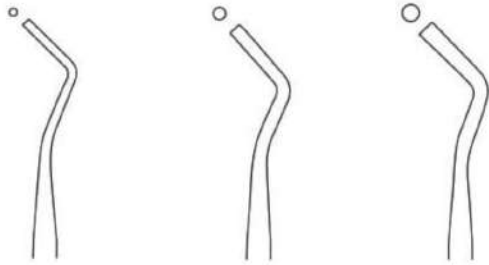

87511-01
Fig. 1

87511-02
Fig. 2

87511-03
Fig. 3



87511-01S
Fig. 1S

87511-02S
Fig. 2S

87511-03S
Fig. 3S



gerieft
fluted
acanalado
scanalato

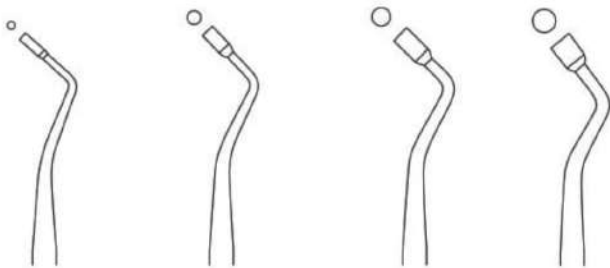

87512-01P
Fig. 1P

87512-02P
Fig. 2P

87512-03P
Fig. 3P

87512-04P
Fig. 4P

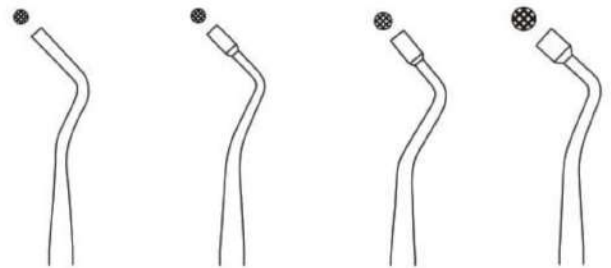

87512-01S
Fig. 1S

87512-02S
Fig. 2S

87512-03S
Fig. 3S

87512-04S
Fig. 4S



Stopfer, Plugger
 Condenser, Plugger
 Condensador, Obturador
 Obturateur, Obturateur

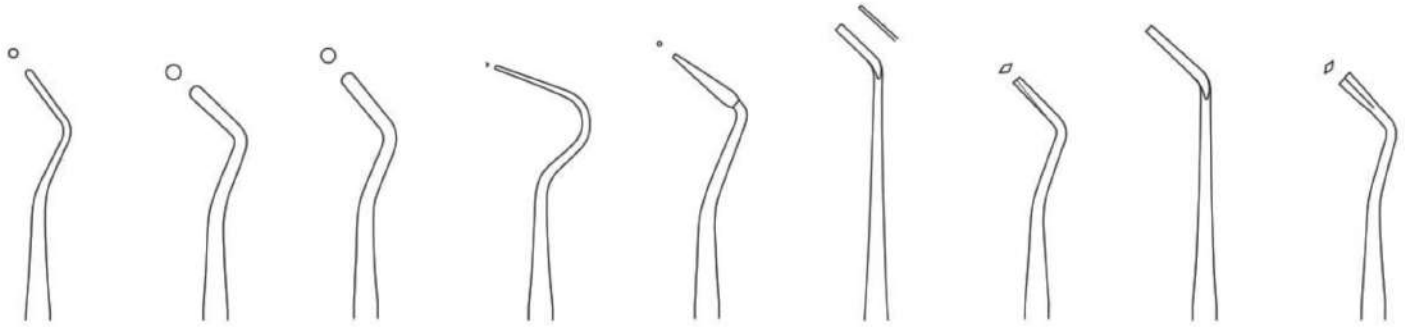

MARKLEY

87513-01 Fig. 1D 87513-02 Fig. 2D 87513-03 Fig. 3D 87514-01 Fig. M1 87514-02 Fig. M2 87514-03 Fig. M3 87514-04 Fig. M4 87514-05 Fig. M5 87514-06 Fig. M6

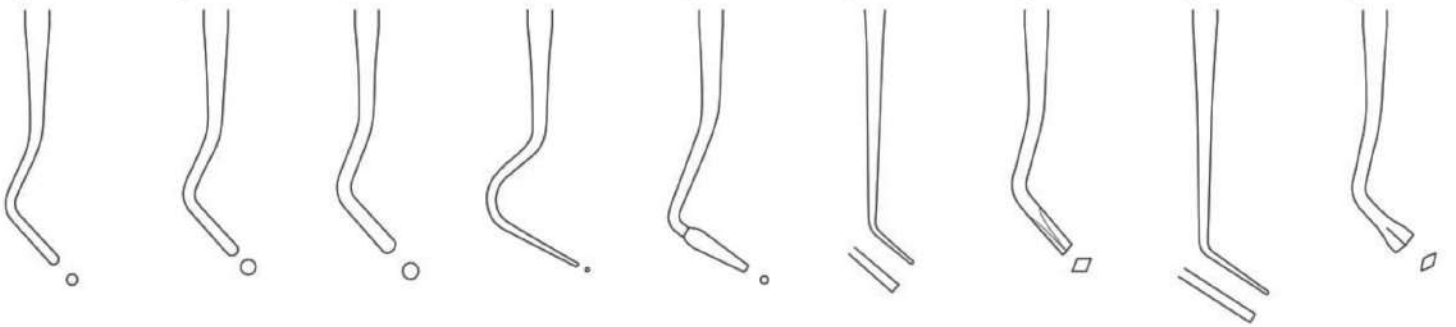

gerieft
 fluted
 acanalado
 scanalato

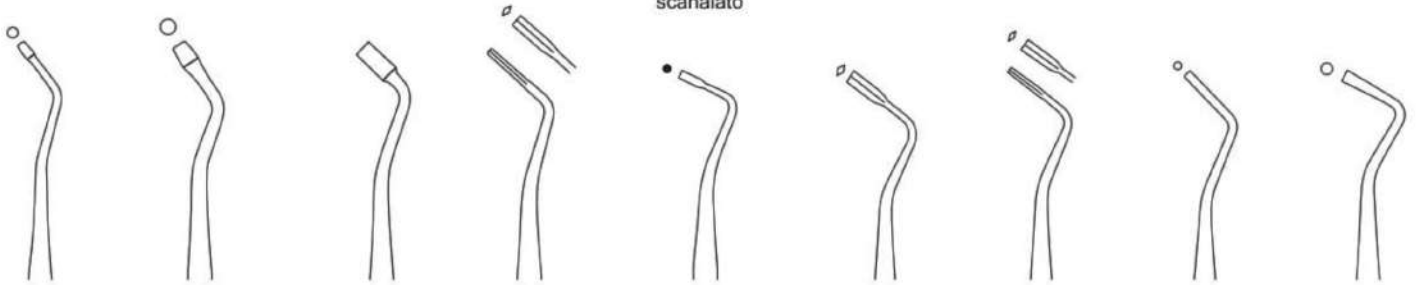

HOLLENBACK

TANNER

87515-01 Fig. H1 87515-02 Fig. H2 87515-03 Fig. H3 87515-04 Fig. H4 87516-01S Fig. MO1S 87517-00 Fig. T0 87517-01 Fig. T1 87517-02 Fig. T2 87517-03 Fig. T3

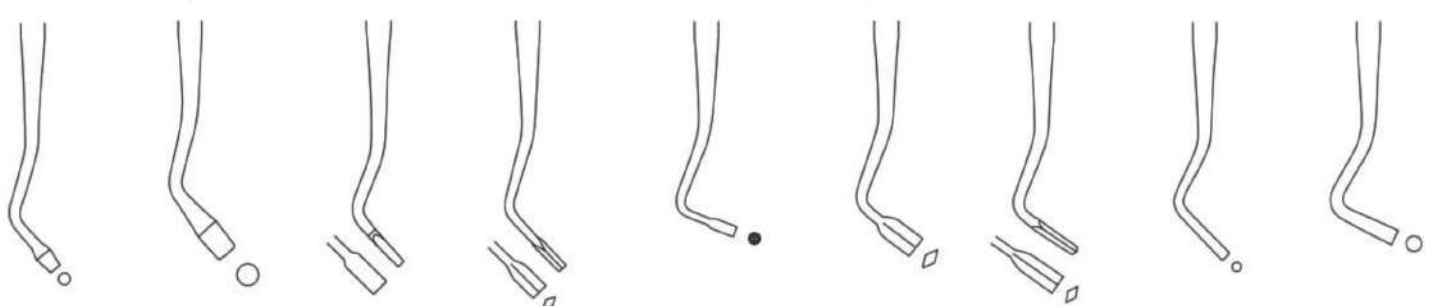

Stopfer
Condenser
Condensador
Obturateur



17,5 cm, 7"

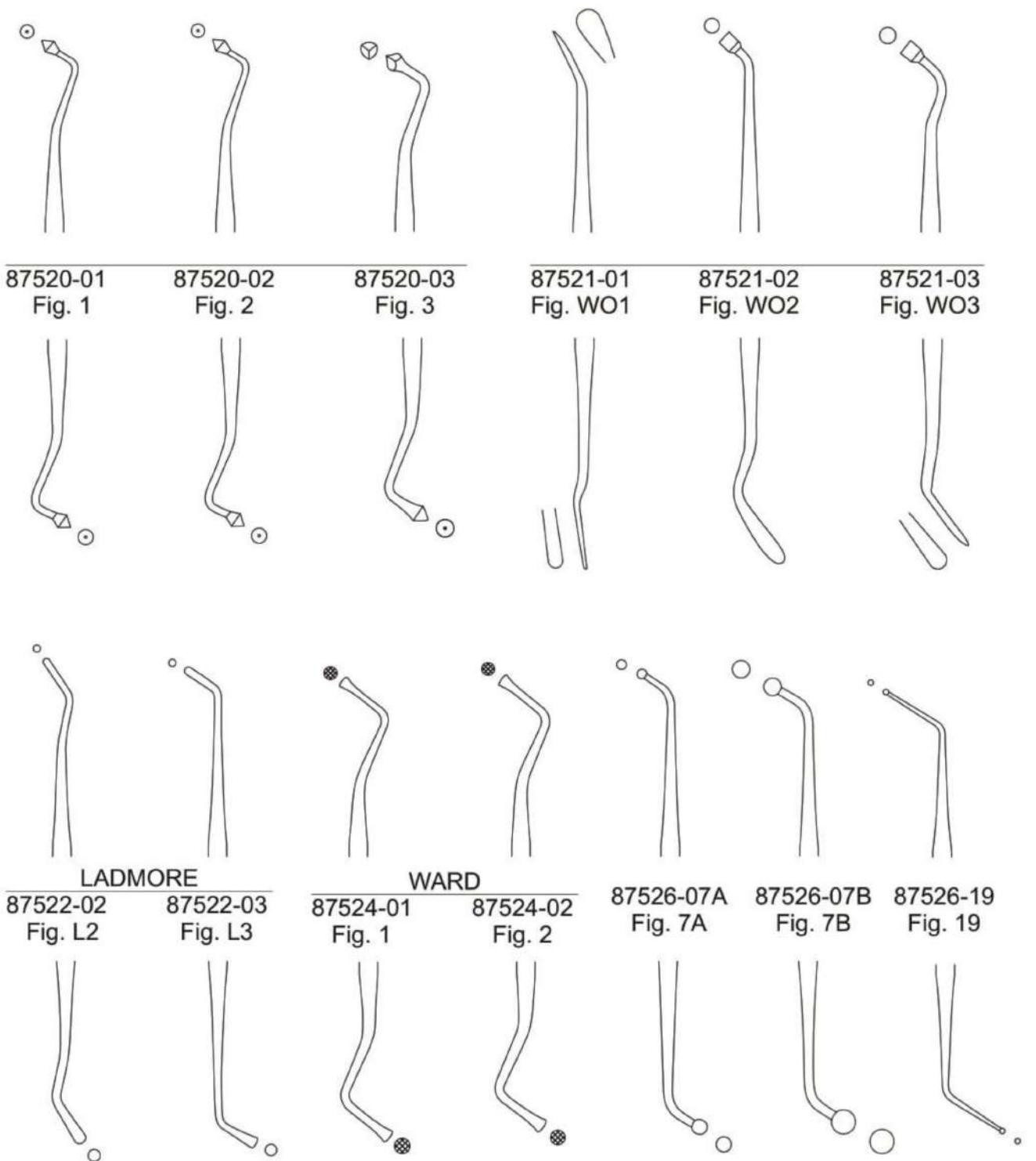

Spatel
Spatula
Espátula
Spatola

scharf
sharp
afilado
affilato

2,0 mm

2,5 mm

3,0 mm

2,0 mm

2,5 mm

3,0 mm



17,5 cm, 7"

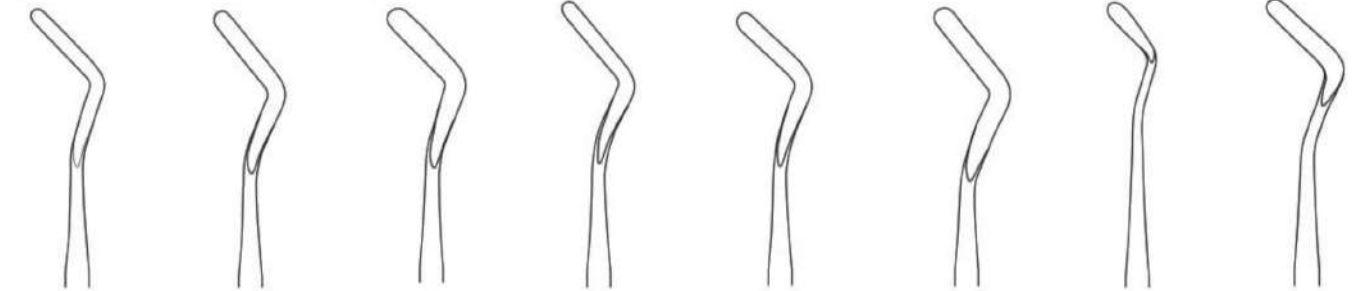

87530-01
Fig. 1

87530-02
Fig. 2

87530-03
Fig. 3

87530-11
Fig. 11

87530-12
Fig. 12

87530-13
Fig. 13

87532-06
Fig. 6

87532-11
Fig. 11

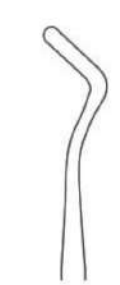
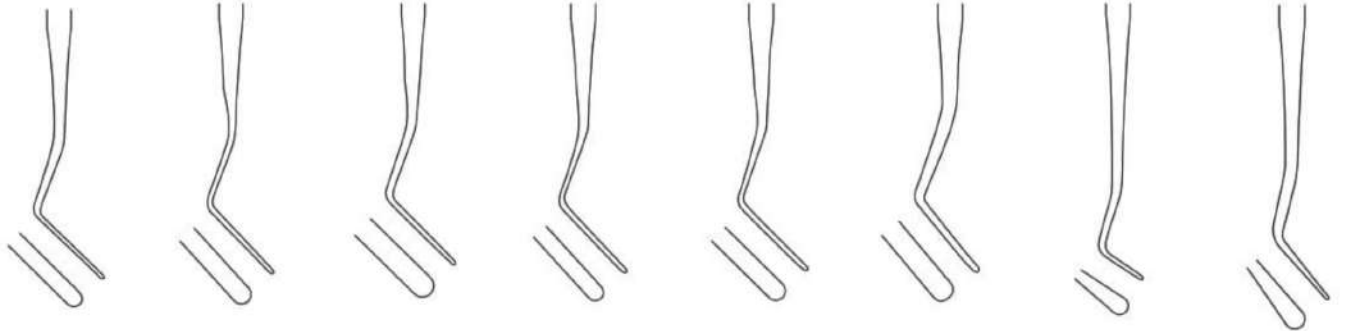

87532-79
Fig. 179

87531-01
Fig. 1

87531-02
Fig. 2

87531-03
Fig. 3

87531-10
Fig. 10

87531-11
Fig. 11A

87531-12
Fig. 12

87531-13
Fig. 13

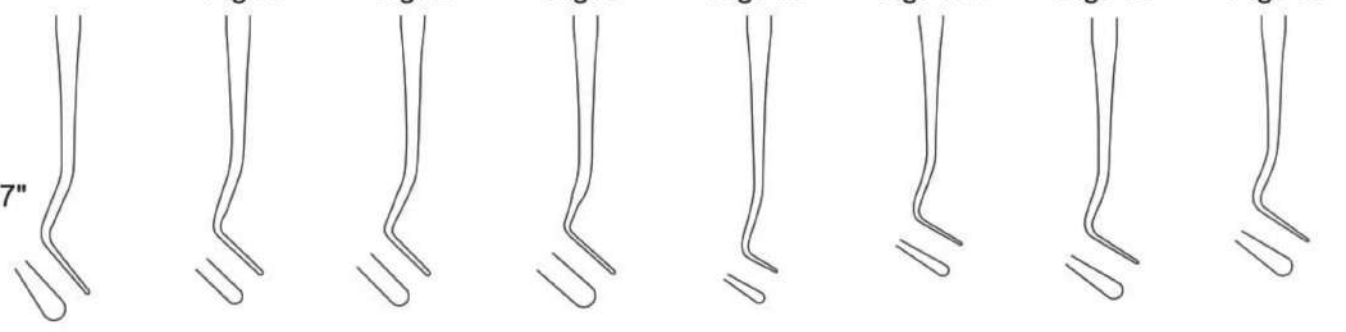

Kugel/Spatel-Kombination
 Ball/spatula combination
 Combinación bola/espátula
 Combinazione sfera/spatola



17,5 cm, 7"

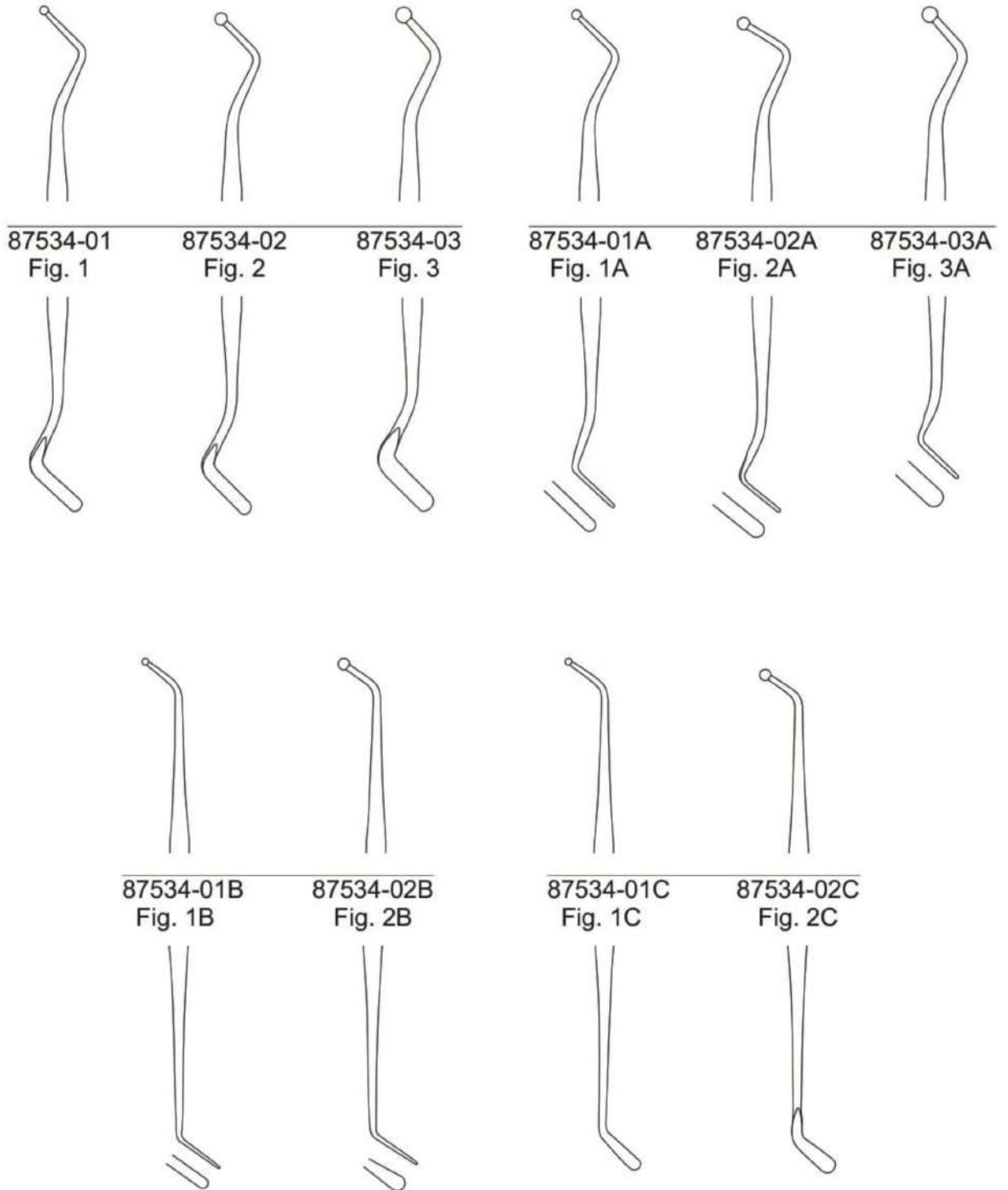

Zementspatel
Cement mixing spatula
Espátula para cemento
Spatola per cemento



17,5 cm, 7"



87537-00
Fig. 00



87538-00
Fig. 0



87538-01
Fig. 1



87538-02
Fig. 2



87538-03
Fig. 3



87538-04
Fig. 4



87539-02
Fig. 2

Matrizen und Matrizenspanner
Matrix bands and retainers
Portamatrices y matrices
Portamatrici e matrici



IVORY
87540-01
Fig. 1



IVORY
87540-12
Fig. 12



IVORY
87540-12A
Fig. 12A



TOFFLEMIRE
Junior 87542-01
Universal 87542-00



IVORY
Fig. 8
5 mm 87545-05
6 mm 87545-06
7 mm 87545-07

IVORY

12 Stück
12 pieces
12 piezas
12 pezzi



87541-01
Fig. 1



87541-04
Fig. 4



TOFFLEMIRE
87543-01
Fig. 1



87544-10
Fig. 10



87541-02
Fig. 2



87541-05
Fig. 5



TOFFLEMIRE
87543-13
Fig. 13



87544-11
Fig. 11



87541-03
Fig. 3



87541-06
Fig. 6



87544-07
Fig. 7



87544-12
Fig. 12

für Molaren
for molars
para molares
per molari

für Prämolaren
for premolars
para premolares
per premolari



87544-08
Fig. 8



87544-13
Fig. 13



5 mm x 1 m 87546-05
6 mm x 1 m 87546-06
7 mm x 1 m 87546-07



87544-09
Fig. 9

Kofferdam-Instrumente
Rubber dam instruments
Dique de goma
Kofferdam



AINSWORTH
87550-16
16 cm, 6¹/₄"

Kofferdam-Lochzange
Punch forceps
Perforadores
Pinze foradiga



USA
87551-15
15 cm, 6"

Kofferdam-Klammerzange
Clamp forceps
Portaclamps
Pinze per uncini



IVORY
87552-16
16 cm, 6¹/₄"



BREWER
87553-17
17 cm, 6³/₄"



STOCKES
87554-17
17 cm, 6³/₄"

Kofferdam-Instrumente
 Rubber dam instruments
 Dique de goma
 Kofferdam

Kofferdam-Halter
 Rubber dam holder
 Sostenedor
 Supporto per kofferdam

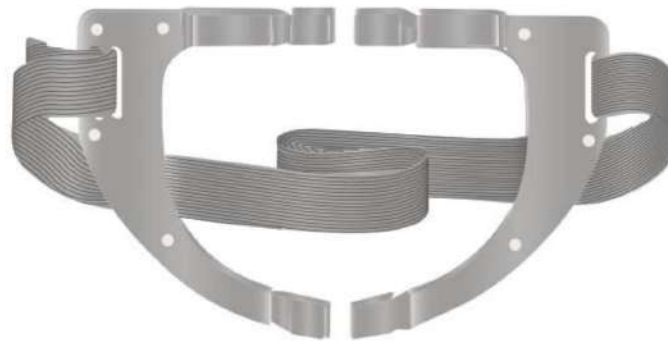

WIZARD
 87560-60
 Fig. 60

Klammern
 Clamps
 Clamps
 uncini



87561-26
 Fig. 26



87561-27
 Fig. 27



87561-28
 Fig. 28



87561-29
 Fig. 29

IVORY



87561-30
 Fig. 30



87561-31
 Fig. 31



87561-51
 Fig. 51



87561-60
 Fig. 60

Abdrucklöffel, gelocht
 Impression trays, perforated
 Cubetas para impresiones, perforadas
 Portaimpronte, perforata

für bezahnte Oberkiefer
 for toothed upper jaws
 para mandibulas superiores dentadas
 per mascella superiore dentata



Form BO (SUP/B)	
87600-00	Fig. 0
87600-01	Fig. 1
87600-02	Fig. 2
87600-03	Fig. 3
87600-04	Fig. 4

für bezahnte Unterkiefer
 for toothed lower jaws
 para mandibulas inferiores dentadas
 per mascella inferiore dentata



Form BU (INF/B)	
87601-00	Fig. 0
87601-01	Fig. 1
87601-02	Fig. 2
87601-03	Fig. 3
87601-04	Fig. 4

für partiell bezahnte Oberkiefer
 for partially toothed upper jaws
 para mandibulas superiores parcialmente dentadas
 per mascella superiore parzialmente dentata

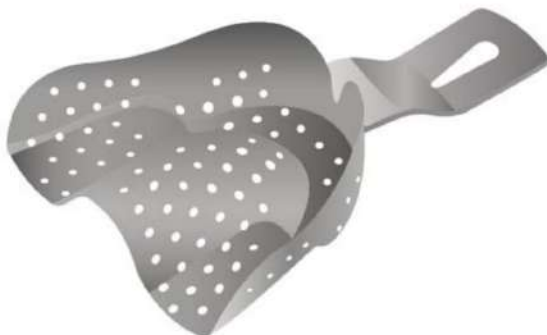

Form PO (SUP/P)	
87602-01	Fig. 1
87602-02	Fig. 2
87602-03	Fig. 3

für partiell bezahnte Unterkiefer
 for partially toothed lower jaws
 para mandibulas inferiores parcialmente dentadas
 per mascella inferiore parzialmente dentata



Form PU (INF/P)	
87603-01	Fig. 1
87603-02	Fig. 2
87603-03	Fig. 3

Abdrucklöffel, gelocht
 Impression trays, perforated
 Cubetas para impresiones, perforadas
 Portaimpronte, perforata

für unbezahnte Oberkiefer
 for edentulous upper jaws
 para mandibulas superiores desdentadas
 per mascella superiore edentula



Form UO (SUP/U)	
87604-01	Fig. 1
87604-02	Fig. 2
87604-03	Fig. 3

für unbezahnte Unterkiefer
 for edentulous lower jaws
 para mandibulas inferiores desdentadas
 Per mascella inferiore edentula



Form UU (INF/U)	
87605-01	Fig. 1
87605-02	Fig. 2
87605-03	Fig. 3

für Funktionsabdrücke im Oberkiefer
 for upper functional impressions
 para impresiones funcionales superiores
 per impronte funzionali nella mascella superiore dentata



Form FO (SUP/F)	
87606-01	Fig. 1
87606-02	Fig. 2
87606-03	Fig. 3

Abdrucklöffel, ungelocht
 Impression trays, unperforated
 Cubetas para impresiones, no perforadas
 Portaimpronte, non perforata

für bezahnte Oberkiefer
 for toothed upper jaws
 para mandibulas superiores dentadas
 per mascella superiore dentata

für bezahnte Unterkiefer
 for toothed lower jaws
 para mandibulas inferiores dentadas
 per mascella inferiore dentata

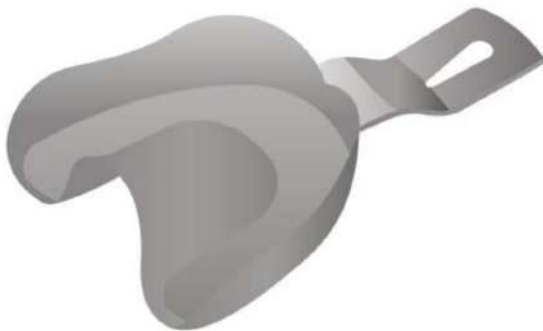

Form BO (SUP/B)	
87610-00	Fig. 0
87610-01	Fig. 1
87610-02	Fig. 2
87610-03	Fig. 3
87610-04	Fig. 4

Form BU, Fig. 0 (INF/B)	
87611-00	Fig. 0
87611-01	Fig. 1
87611-02	Fig. 2
87611-03	Fig. 3
87611-04	Fig. 4

für partiell bezahnte Oberkiefer
 for partially toothed upper jaws
 para mandibulas superiores parcialmente dentadas
 per mascella superiore parzialmente dentata

für partiell bezahnte Unterkiefer
 for partially toothed lower jaws
 para mandibulas inferiores parcialmente dentadas
 per mascella inferiore parzialmente dentata

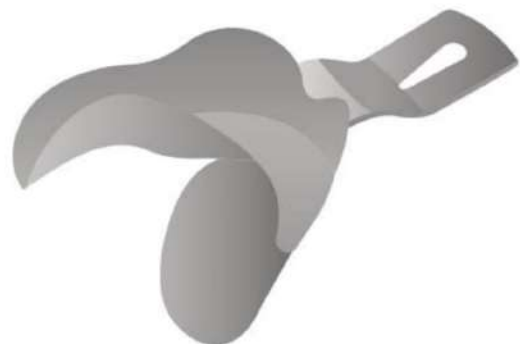
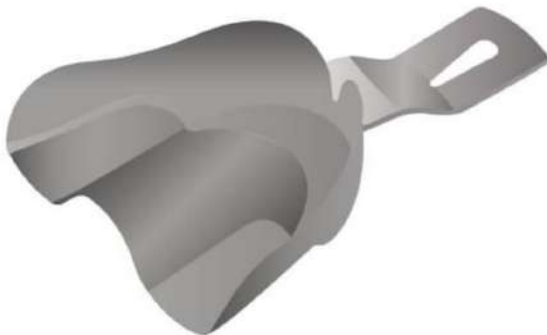

Form PO (SUP/P)	
87612-01	Fig. 1
87612-02	Fig. 2
87612-03	Fig. 3

Form PU (INF/P)	
87613-01	Fig. 1
87613-02	Fig. 2
87613-03	Fig. 3

Abdrucklöffel, ungelocht
 Impression trays, unperforated
 Cubetas para impresiones, no perforadas
 Portaimpronte, non perforata

für unbezahnte Oberkiefer
 for edentulous upper jaws
 para mandibulas superiores desdentadas
 per mascella superiore edentula

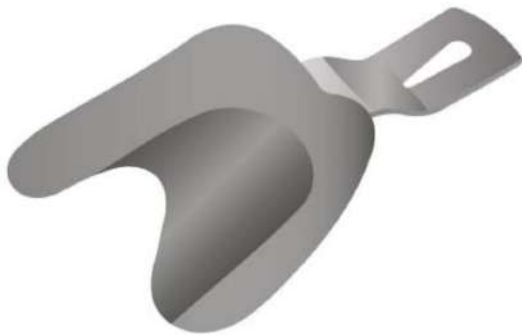

Form UO (SUP/U)

87614-01	Fig. 1
87614-02	Fig. 2
87614-03	Fig. 3

für unbezahnte Unterkiefer
 for edentulous lower jaws
 para mandibulas inferiores desdentadas
 Per mascella inferiore edentula



Form UU (INF/U)

87615-01	Fig. 1
87615-02	Fig. 2
87615-03	Fig. 3

für Funktionsabdrücke im Oberkiefer
 for upper functional impressions
 para impresiones funcionales superiores
 per impronte funzionali nella mascella superiore dentata

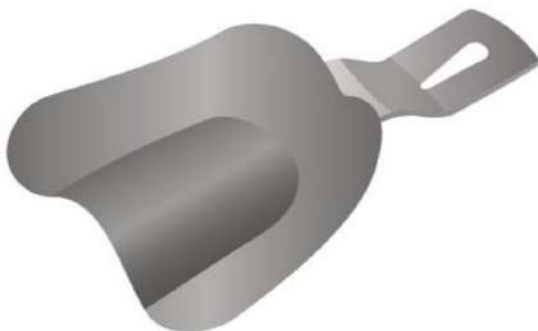

Form FO (SUP/F)

87616-01	Fig. 1
87616-02	Fig. 2
87616-03	Fig. 3

Abdrucklöffel für partielle Abdrücke
 Impression trays for partial impressions
 Cubetas para impresiones parciales
 Portaimpronte parziali

geloht
 perforated
 perforado
 perforato

Form C1/2R

- | | |
|----------|--------|
| 87608-01 | Fig. 1 |
| 87608-02 | Fig. 2 |
| 87608-03 | Fig. 3 |



Form C1/2L

- | | |
|----------|--------|
| 87609-01 | Fig. 1 |
| 87609-02 | Fig. 2 |
| 87609-03 | Fig. 3 |



ungeloht
 unperforated
 no perforado
 non perforato

Form C1/2R

- | | |
|----------|--------|
| 87618-01 | Fig. 1 |
| 87618-02 | Fig. 2 |
| 87618-03 | Fig. 3 |



Form C1/2L

- | | |
|----------|--------|
| 87619-01 | Fig. 1 |
| 87619-02 | Fig. 2 |
| 87619-03 | Fig. 3 |



Fadenstopfer / Spatel
Gingival cord packer / spatulas
Instrumentos para hilo retractor / espátulas
Strumenti per fili di retrazione / spatole



87630-01
17,5 cm, 7"
Fig. 1



87630-02
17,5 cm, 7"
Fig. 2

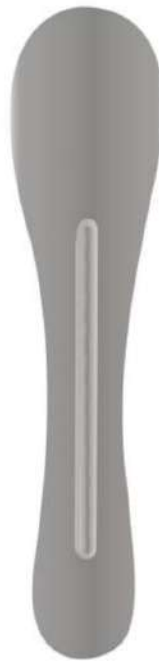

LICHTENSTEIN
87632-17
17 cm, 6³/₄"

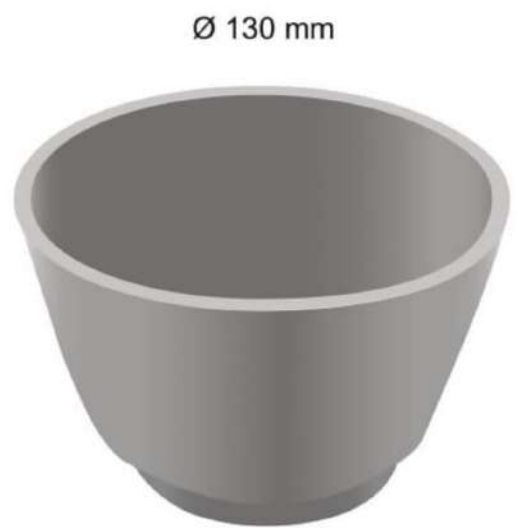

87634-10
Weichgummi
soft rubber
goma blanda
gomma morbida

87634-20
Kunststoff
plastic
plástico
plastica

Ø 130 mm

Wachs-, Porzellan- und Modellierinstrumente
 Wax, porcelain and modelling carvers
 Talladores y espátulas para cera, porcelana y modelar
 Strumenti per modellare

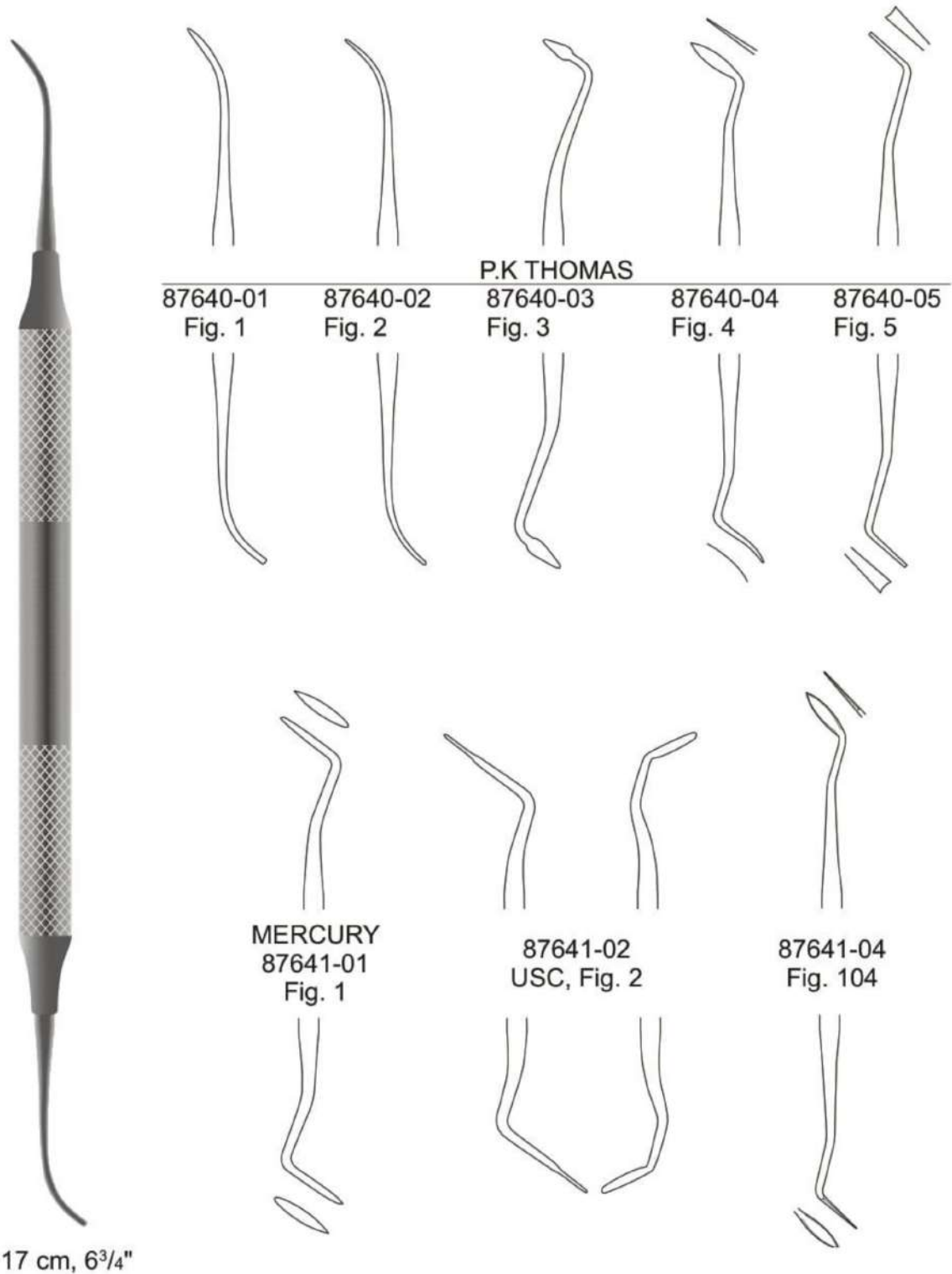

Wachs-, Porzellan- und Modellierinstrumente
 Wax, porcelain and modelling carvers
 Talladores y espátulas para cera, porcelana y modelar
 Strumenti per modellare

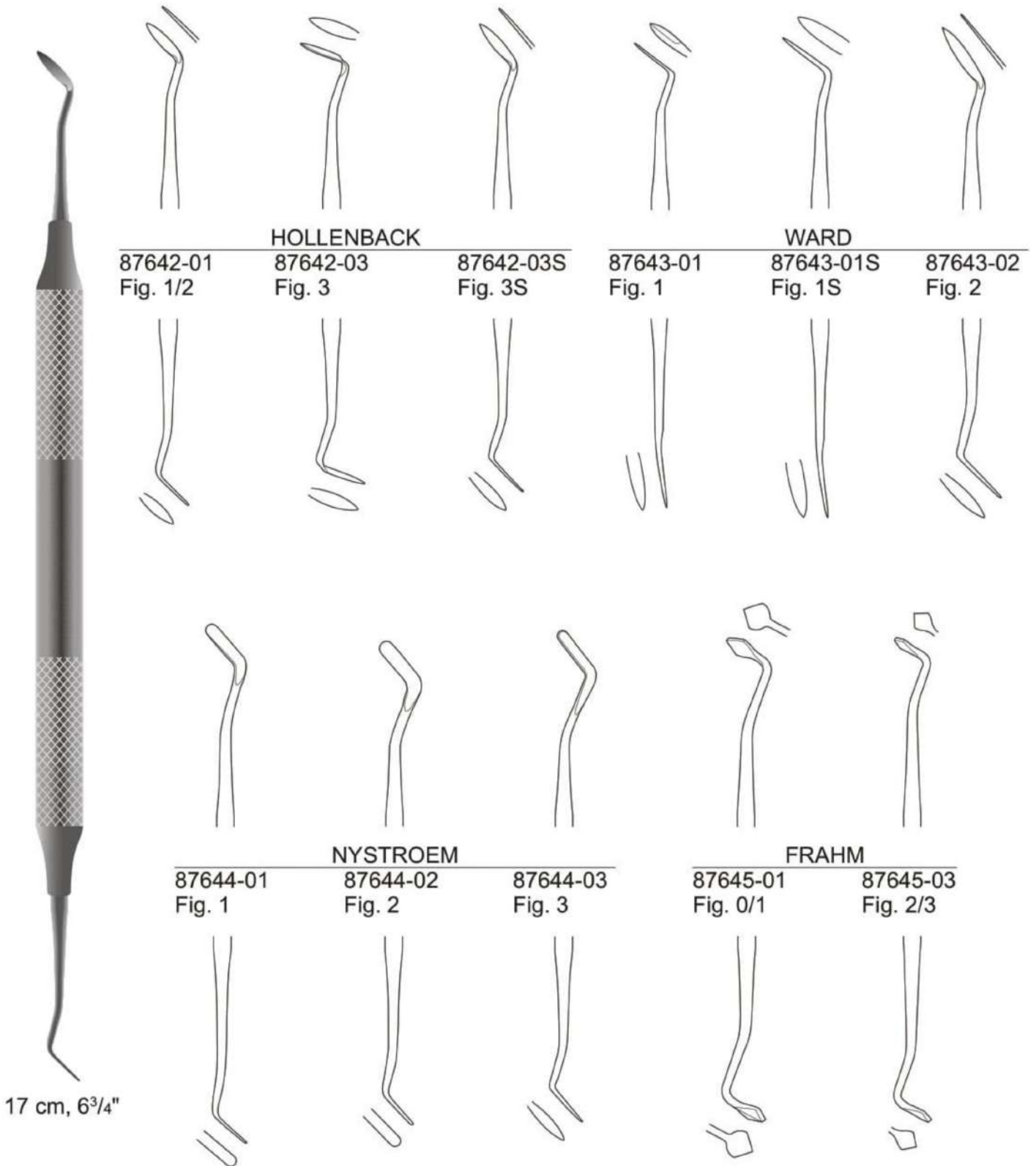

Wachs-, Porzellan- und Modellierinstrumente
 Wax, porcelain and modelling carvers
 Talladores y espátulas para cera, porcelana y modelar
 Strumenti per modellare

für interdental Anwendungen
 for interdental applications
 para aplicaciones interdenciales
 per applicazioni interdentali

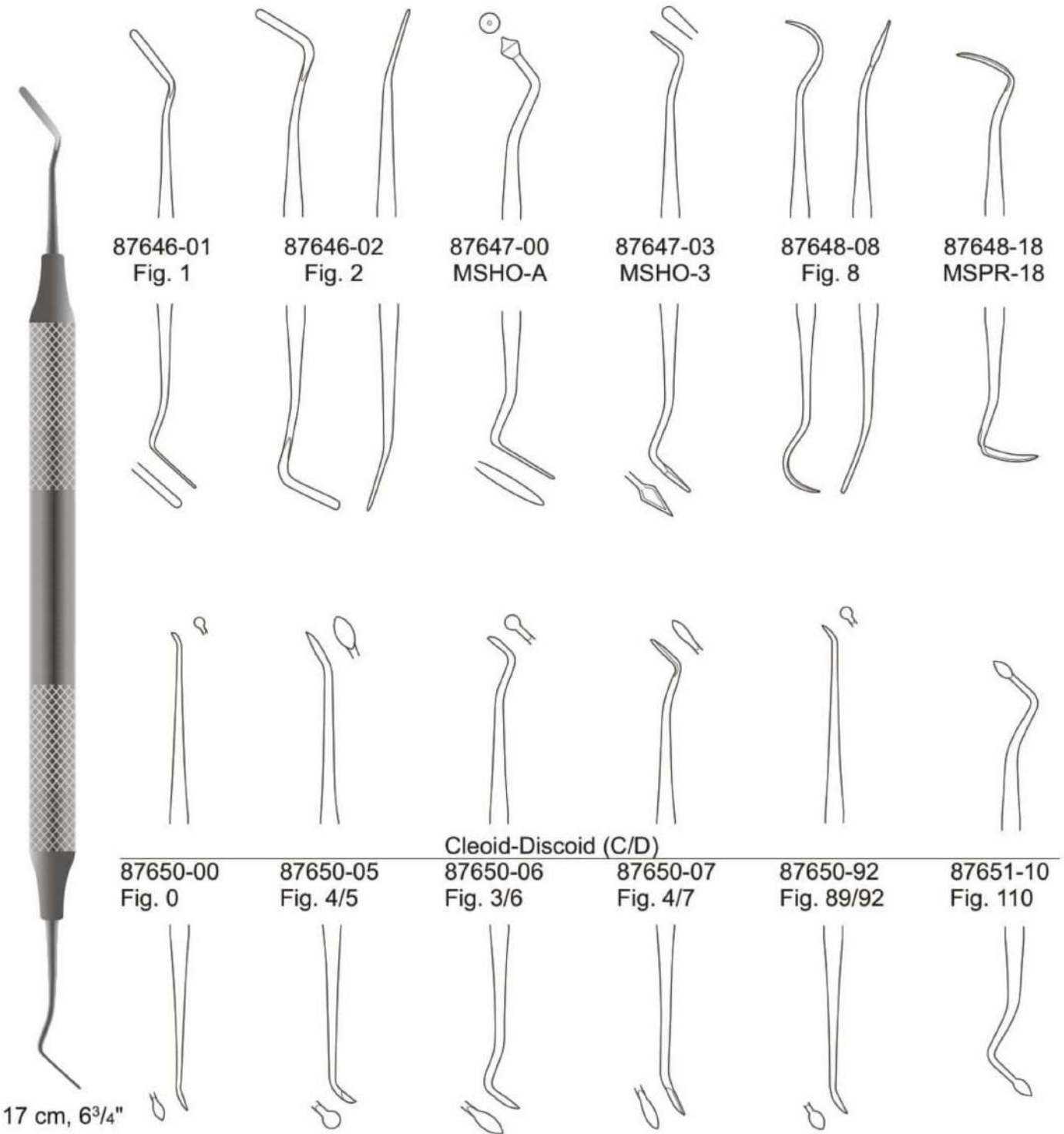

Wachs-, Porzellan- und Modellierinstrumente
Wax, porcelain and modelling carvers
Talladores y espátulas para cera, porcelana y modelar
Strumenti per modellare



HYLIN
87654-10



ZAHLE
87654-20



Le CRON
87654-01
Fig. 1



BEALE
87654-02
Fig. 1

Wachs-, Porzellan- und Modellierinstrumente
 Wax, porcelain and modelling carvers
 Talladores y espátulas para cera, porcelana y modelar
 Strumenti per modellare

Wachsmesser
 Wax knife
 Cuchillo para cera
 Coltello per gesso

Gipsmesser
 Plaster knife
 Cuchillo para yeso
 Coltello per gesso

Artikulationspapier-Pinzetten
 Articulating paper forceps
 Pinzas para papel de articulación
 Pinzette per carta di articolazione



Wachsmesser
 Wax knife
 Cuchillo para cera
 Coltello per gesso



GISY-WILD
 87660-15
 15 cm, 6"

GRITMANN
 87661-17

FAHNENSTOCK
 13 cm, 5" 87662-13
 17 cm, 6¼" 87662-17

MILLER
 87665-15
 15 cm, 6"

MILLER
 87666-15
 15 cm, 6"

Kroneninstrumente
Instruments for crown work
Instrumentos para coronas
Strumenti per corone

Bandtreiber
Band pusher
Ajustador de bandas
Dispositivo di azionamento del nastro



MERSON
87670-00

Kronensetzer
Crown setter
Fijador de coronas
Fissatore per corona



87671-00

Kronenaufbieger
Crown spreader
Alicates extendedores de coronas
Estensore per corona



87680-00

Kroneninstrumente
 Instruments for crown work
 Instrumentos para coronas
 Strumenti per corone

Kronenabnehmer (Hirtenstab)
 Crown remover
 Extractor de coronas
 Estrattore per corona



TREYEMANN
 87684-00

mit 3 Einsätzen und Ersatzschlüssel
 with 3 inserts and spare key
 con 3 piezas de inserción y llave de repuesto
 con 3 inserti e chiave di ricambio

CROWN-BUTLER
 87685-01
 Fig. 1



Einsatz für Crown-Butler, Fig. 1 + 2
 Insert for Crown-Butler, Fig. 1 + 2
 Pieza de inserción para el Crown-Butler, Fig. 1 + 2
 Insetto per Crown-Butler, Fig. 1 + 2



CROWN-BUTLER
 87685-02
 Fig. 2

mit 3 Einsätzen
 with 3 inserts
 con 3 piezas de inserción
 con 3 inserti

87685-11
 Fig. 1A

87685-12
 Fig. 2A

87685-13
 Fig. 3A

Kroneninstrumente
Instruments for crown work
Instrumentos para coronas
Strumenti per corone

Teleskopkronenzange
Telescopic crown pliers
Alicates telescópicos para coronas
Pinzette telescopiche per coronas



87690-13

DIAMANT
87692-13

Diamanteinsätze für
Teleskopkronenzange

Diamond inserts for telescopic
crown pliers

Piezas de inserción de diamante para
alicates telescópicos para coronas

Inseriti di diamante per pinzette
telescopiche per corone



87692-00

Inbusschlüssel für
Teleskopkronenzange

Hex key for telescopic
crown pliers

Llave hexagonal para alicates
telescópicos para coronas

Tasto esagonale per pinzette
telescopiche per corone



87692-01

Drahtscheren, Drahtkneifzangen
 Wire cutting scissors, Wire Cutting Pliers
 Tijeras para alambre, Alicates para cortar alambres
 Forbici per filo metallico, Tronchese taglienti

für weichen Draht bis 2,0 mm Ø
 for soft wires up to 2,0 mm Ø
 para hilos blandos hasta 2,0 mm Ø
 per fili dolci fino a 2,0 mm Ø



UNIVERSAL
 09831-12 12 cm, 4³/₄"
 09835-12 TC 12 cm, 4³/₄"



BEEBEE
 10,5 cm, 4"

09850-10
 gerade spitz
 straight pointed
 rectas agudas
 rette acute

09851-10
 gebogen spitz
 curved pointed
 curvas agudas
 curve acute



34540-16
 16 cm, 6¹/₄"

für weichen Draht bis 2,0 mm Ø
 for soft wires up to 2,0 mm Ø
 para hilos blandos hasta 2,0 mm Ø
 per fili dolci fino a 2,0 mm Ø

für harten Draht bis 1,6 mm Ø
 for hard wires up to 1,6 mm Ø
 para hilos duros hasta 1,6 mm Ø
 per fili duri a 1,6 mm Ø



34542-15 TC
 15 cm, 6"



34546-16 TC 16 cm, 6¹/₄"
 34546-18 TC 18 cm, 7"



34548-18 TC
 18 cm, 7"

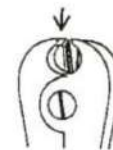

für weichen Draht bis 2,0 mm Ø
 for soft wires up to 2,0 mm Ø
 para hilos blandos hasta 2,0 mm Ø
 per fili dolci fino a 2,0 mm Ø



für harten Draht bis 1,6 mm Ø
 for hard wires up to 1,6 mm Ø
 para hilos duros hasta 1,6 mm Ø
 per fili duri a 1,6 mm Ø

Zwickzangen, Distalschneider
 End and side nippers, Distal cutter
 Alicates cortantes y alicates para doblar alambres
 Tenaglie, Pinza per tagliare filo

soft wire 1,5 mm
 hard wire 1,0 mm



34549-14 TC
 14 cm, 5 1/2"



87720-12
 12,5 cm, 5"



87721-11
 11 cm, 4 1/4"



87722-11 TC
 11 cm, 4 1/4"

Distalschneider
 Distal cutter
 Alicates para cortar alambres
 Pinza per tagliare filo



87723-12 TC
 12 cm, 4 3/4"

Drahtschneidzange
 Wire cutter, front action
 Alicates para cortar alambres
 Pinza per tagliare filo



87725-00 TC
 11,5 cm, 4 1/2"



87726-00 TC
 13 cm, 5"

Rund-, Flachzange
 Flat nose pliers
 Alicates de pico plano
 Tenaglie piatte



MAYO-HABERISSER
 15 cm, 6"



34554-15 TC

Drahtwirbelzangen
 Wire twisting forceps
 Pinzas para torcer alambre
 Pinze per ritorcere fili



18 cm, 7"

2 mm



34538-01

34539-01 TC

4 mm



34538-02

34539-02 TC

6 mm



34538-03

34539-03 TC

Drahtfaßzangen
 Wire Seizing Forceps
 Pinzas para coger alambres
 Tenaglie per afferrare i fili

schmal, gerieft
 narrow, fluted
 estrecho, acanalado
 sottile, scanalato



34540-18
 18 cm, 7"



34536-14
 14,5 cm, 5³/₄"

5 mm



87731-14
 14,5 cm, 5³/₄"



Rund-, Flachzange
 Flat nose pliers
 Alicates de pico plano
 Tenaglie piatte

Konturenzange
 Contouring pliers
 Alicates para contornear
 Tenaglie per profili



87732-13
 13 cm, 5"



87733-13
 13 cm, 5"



GOSLEE
 87733-14
 14,5 cm, 5³/₄"

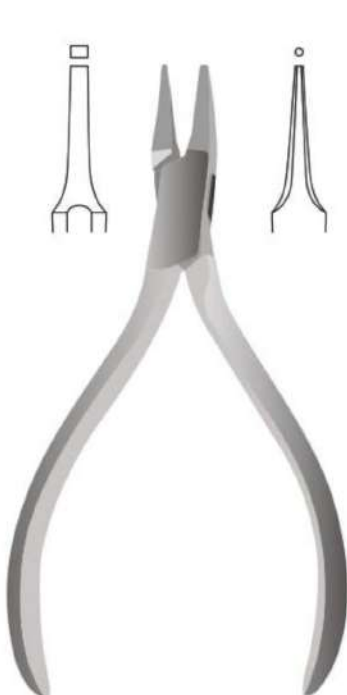

87734-15
 15 cm, 6"

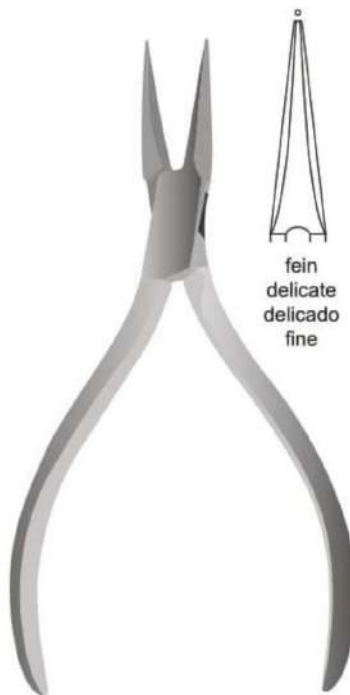

87735-13
 13 cm, 5"

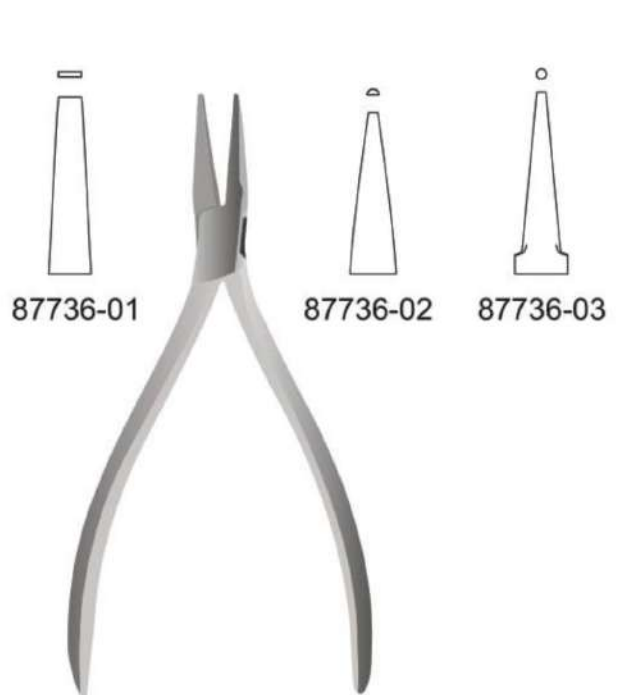

87736-01

87736-02

87736-03

DUMONT
 11,5 cm, 4¹/₂"

fein
 delicate
 delicado
 fine

Drahtbiegezange
Wire bending pliers
Alicate para doblar alambres
Pinza tecnica per filo

Zahntechnikzange
Pliers for dental technic
Pinza de técnica
Pinza per tecnica



WEINGART
87738-12
12,5 cm, 5"

Bandentfernungszange
Band removing pliers
Alicate para sacar bandas
Pinza per levare bande

Teflon



ADERER
87739-14
14 cm, 5 1/2"



TWEED
87743-12
12,5 cm, 5"



ANGLE
87740-12
12 cm, 4 3/4"

fein
delicate
delicado
fine



ANGLE
87741-12
12 cm, 4 3/4"



87742-14
14 cm, 5 1/2"

Draht-, Bogen- und Klammernbiegeezangen
Wire, arch and clasp bending pliers
Alicates para doblar alambres, arcos y ganchos
Tenaglie per la piegatura di fili metallici, staffe e graffe

Bügelbiegezange
 Clasps bending pliers
 Alicates para barras
 Pinza tecnica per piegare forma arco



87744-12
 12 cm, 4³/₄"

Bügelbiegeezangen
 bar bending pliers
 alicates para doblar alambres
 tenaglie per la piegatura di staffe



87746-01
 Fig. 1



87746-02
 Fig. 2



87746-03
 Fig. 3



SCHWARZ
 13 cm, 5"



ADAMS
 87747-13
 13 cm, 5"

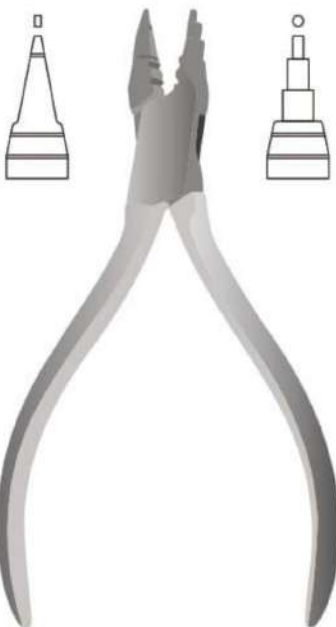

YOUNG
 87748-13
 13 cm, 5"



ADERER
 87749-11
 11,5 cm, 4¹/₂"



ADERER
 87749-13
 13 cm, 5"

Universal-Kramponzange, Brückenabnehmezangen
Universal pliers, bridge removing pliers
Alicates universales, alicates para puentes
Tenaglie universali, tenaglie per la rimozione di ponticelli



WALDSACHS
87750-15
15,5 cm, 6"

Universal-Kramponzange
Universal pliers
Alicates universales
Tenaglie universali



87751-15
15,5 cm, 6"



FURRER
87752-15
15,5 cm, 6"

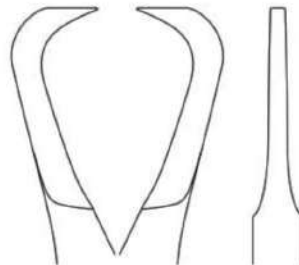

Brückenabnehmezangen
Bridge removing pliers
Alicates para puentes
Tenaglie per la rimozione di ponticelli

Kronenzangen, Konturzangen
Crown pliers, contouring pliers
Alicates para coronas y para contornear
Tenaglie per corone, tenaglie per profili



87754-14



HOW
14 cm, 5 1/2"



87755-14



REYNOLDS
87756-13
13 cm, 5"



JOHNSON
87757-13
13 cm, 5"



ABELL
87758-13
13 cm, 5"

Knochenquetscher, Knochenmühle
Bone crusher, Bone mill
Aplastador óseo, molino de huesos
Strumento per schiacciamento ossa



TOLSDORF
47451-80



87810-00
16,5 cm 6 1/2"

Trepanbohrer
Trepine burs
Trepine
Frese carotatrici trephine

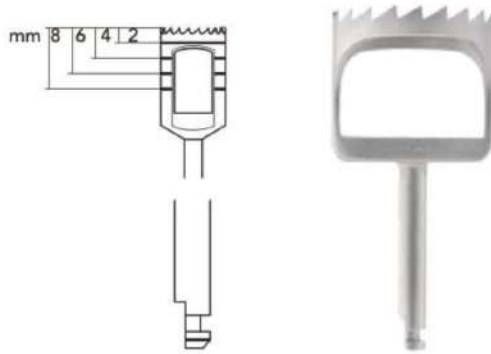

Ø 2,6 mm



Ø 2 mm



87820-02

Ø 4,6 mm



Ø 4 mm



87820-04

Ø 6,8 mm



Ø 6 mm



87820-06

Ø 8,5 mm

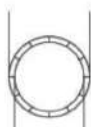

Ø 8 mm



87820-08

Ø 11 mm

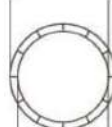

Ø 10 mm



87820-10

Ø 13 mm

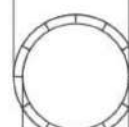

Ø 12 mm



87820-12

Knochenschaber
Bone Scraper
Raspador de hueso
Raschietto osso

Ersatzklinge
Spare blade
Cuchilla de repuesto
Lame di ricambio



87811-09
9,5 cm 3³/₄"



87811-00
15,5 cm 6¹/₂"

Ersatzklinge
Spare blade
Cuchilla de repuesto
Lame di ricambio



87811-05
5 cm 2"



87811-01
15,5 cm 6¹/₂"

Sinus Lift Küretten
Sinus Lift Currettes
Curetas para Sinus Lift
Curette Sinus Lift

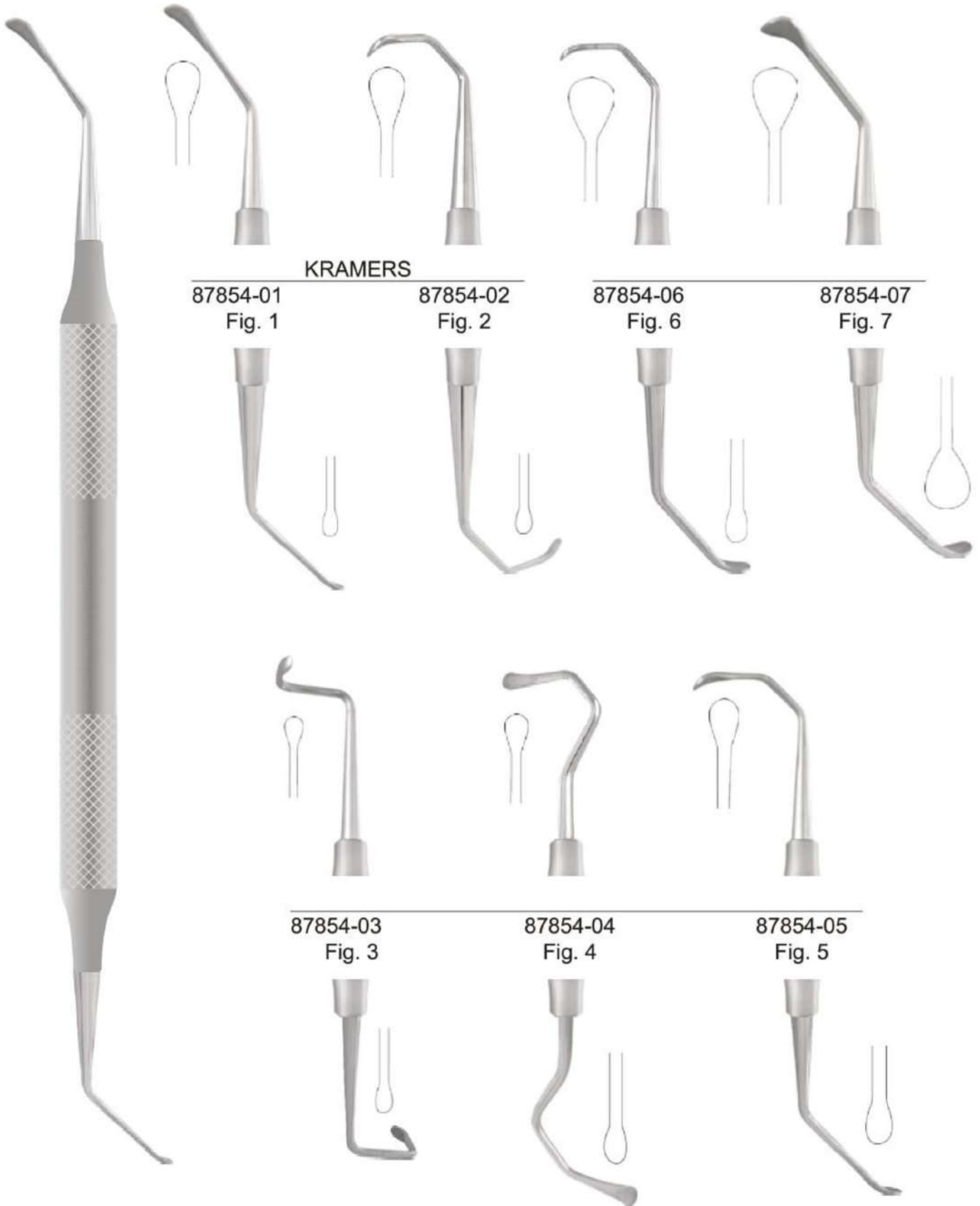

Sterilisierzangen, Abfallzange, Sterilisierklammern
Sterilization Instruments, Waste Forceps, Safety pins
Instrumentos para la esterilización, Pinza para desechos, Cadres de esterilización
Pinze per la sterilizzazione, Pinza per rifiuti, Spilloni p. sterilizzazione



CHEATTLE
29110-27
27 cm, 10¹/₂"



29140-20 20 cm, 8"
29140-30 30 cm, 11³/₄"



SAUERBRUCH
29145-55
55 cm, 21.7"



BUNT
29150-12 12 cm, 4³/₄"



MAYO
29152-14 14 cm, 5¹/₂"

Reinigungsbürsten
Cleaning brushes
Cepillos de limpieza
Spazzole per pulire

Nylonborsten
Nylon bristles
Cerdas de nailon
Scovolino in nylon

Naturborsten
Natural bristles
Cerdas naturales
Scovolino naturale

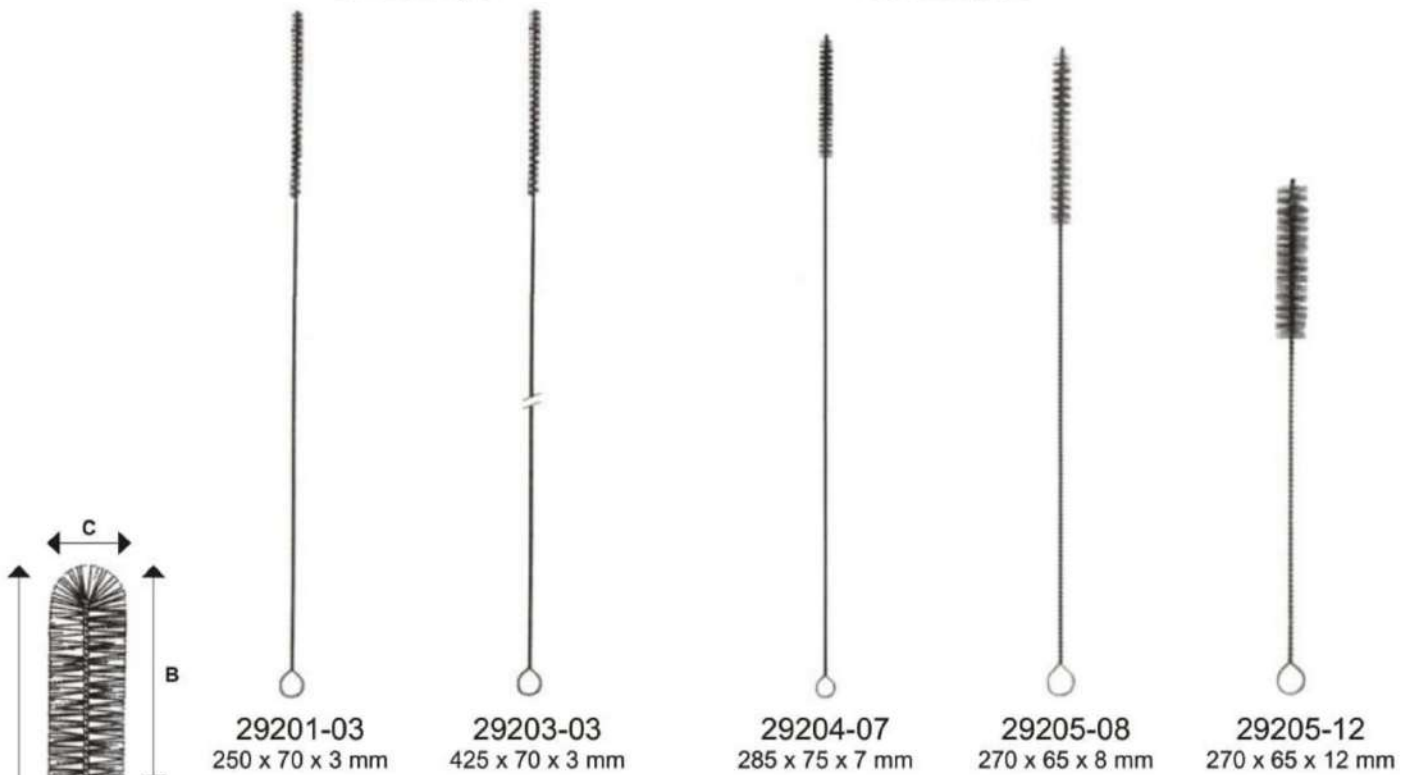

Naturborsten
Natural bristles
Cerdas naturales
Scovolino naturale



Kappenzangen, Nadel-Sterilisierkästen
 Sterilizing Forceps, Needle Sterilizing cases
 Combinacion tapa-pinza, Estuches para esterilizar agujas
 Pinza coperchio, Scatole per sterilizzare aghi

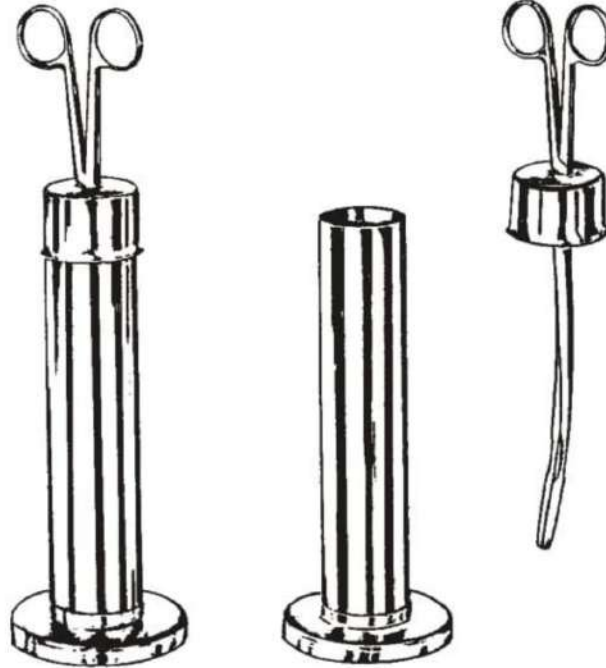

89111-25 25 cm, 10"
 89111-32 32 cm, 12³/₄"



89112-65
 65 x 15 mm



89113-65



89114-00
 150 x 95 x 13 mm



89115-50 50 x 25 x 4,5 mm
 89115-65 65 x 42 x 8,0 mm
 89115-75 75 x 25 x 4,5 mm



89116-50 50 x 25 x 4,5 mm
 89116-65 65 x 42 x 8,0 mm
 89116-75 75 x 25 x 4,5 mm

Instrumentenkästen
Instrument Boxes
Cajas para instrumentos
Scatole per strumenti

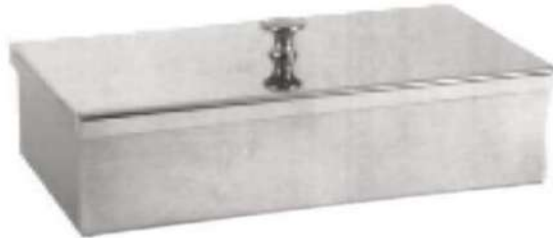

Abmessungen in mm
Sizes in mm
tamaños en mm
misura in mm

l x b x h mm

400 x 200 x 80 89121-40

500 x 270 x 70 89121-50

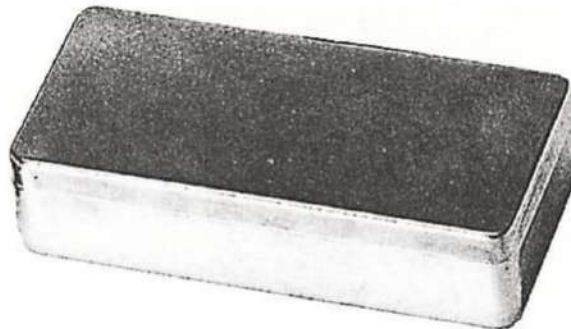

Abmessungen in mm
Sizes in mm
tamaños en mm
misura in mm

Deckel ohne Knopf
lid without knob
tapa sin botón
coperchio senza bottone

l x b x h mm

165x 85x35 89122-16

200x100x50 89122-21

260x150x50 89122-26

300x200x50 89122-30

Bereitschaftskästen
 Storage cases
 Cajas para almacenaje
 Scatole per magazzino



Abmessungen in mm (l x b x h)
 Sizes in mm (l x b x h)
 tamaños en mm (l x f x a)
 misura in mm (l x l x a)

Behälter
 Containers
 Recipientes
 Recipienti

Satz Spezialfilter (5 Paar)
 Set of special filters (5 pairs)
 Juego de filtros especiales (5 pares)
 Set die 5 paia di filtri speciali

230 x 130 x 50
 260 x 150 x 50
 275 x 235 x 50
 300 x 200 x 50
 325 x 275 x 50
 420 x 175 x 50

89124-23
 89124-26
 89124-27
 89124-30
 89124-32
 89124-42

89126-23
 89126-26
 89126-27
 89126-30
 89126-32
 89126-42

230 x 130 x 75
 260 x 150 x 75
 300 x 200 x 75
 325 x 275 x 75
 420 x 175 x 75

89125-23
 89125-26
 89125-30
 89125-32
 89125-42

89127-23
 89127-26
 89127-30
 89127-32
 89127-42

Schüsseln
Bowls
Cubetas
Scondelle

18/10
Stainless Steel
Acero inoxidable
Acciajo inossidabile

matt
satin finish
pulidas mate
opaco



Abmessungen in mm
sizes in mm
Tamaños en mm
misura in mm

Inhalt
capacity
capacidad
capacità

Ø x h	l	
40 x 19	0,05	89127-04
61 x 30	0,07	89127-06
80 x 40	0,14	89127-08
116 x 50	0,35	89127-11
128 x 55	0,45	89127-12
147 x 65	0,70	89127-14
167 x 75	1,10	89127-16
187 x 85	1,60	89127-18

Abmessungen in mm
sizes in mm
Tamaños en mm
misura in mm

Inhalt
capacity
capacidad
capacità

Ø x h	l	
100 x 30	0,15	89129-11



	mm x mm	l
89133-16	165 x 60	0,75
89133-17	175 x 70	1,00
89133-22	220 x 80	2,00
89133-24	240 x 110	3,00
89133-31	310 x 120	6,00
89133-34	345 x 125	8,50
89133-38	380 x 130	11,00

89139-17	170 x 100 x 35 mm	0,50 l
89139-25	250 x 140 x 40 mm	1,25 l
89139-27	275 x 150 x 45 mm	2,25 l

Meßbecher, Dose, Standgefäß, Mehrzweckschalen
 Graduated Measures, Box, Jars, Universal Trays
 Copas graduadas, Recipientes, Tarros, Bandejas para instrumentos
 Bicchieri graduati, Recipienti, Recipienti cilindrici, Bacinelle per strumenti



l	
0,25	89140-02
0,5	89140-05
1,0	89140-10
2,0	89140-20



89141-10
100 x 20 mm

18/10
Stainless Steel
Acero inoxidable
Acciaio inossidabile

matt
satin finish
pulidas mate
opaco



	mmxmm
89142-01	30x 90
89142-02	50x100
89142-03	50x130
89142-04	50x175
89142-05	75x100
89142-06	75x130
89142-07	75x175



89147-21 - 89147-42

	l x b x h
89147-21	210 x 160 x 10 mm
89147-24	240 x 180 x 10 mm
89147-30	310 x 150 x 10 mm
89147-31	310 x 210 x 10 mm
89147-35	350 x 240 x 10 mm
89147-40	400 x 270 x 20 mm
89147-42	420 x 280 x 10 mm



89145-23 - 89145-40

	l x b x h
89145-23	230 x 155 x 30 mm
89145-30	300 x 175 x 30 mm
89145-31	300 x 175 x 40 mm
89145-35	350 x 240 x 36 mm

Wattedosen, Medizinlöffel, -becher
 Cotton wool containers, Medicine Spoon and Cups
 Distribuidores de algodón, Cuchara graduada, Vasos graduados
 Vaso portacotone, Cucchiaino per medicinali, bicchieri per medicinali



mit Deckel
 with Lid
 Tapa
 Coperchio



89146-20 20 cc
 110 x 20 mm

	∅	h	l
89143-00	6 cm	6 cm	0,15 l
89143-01	8,5 cm	8,5 cm	0,4 l
89143-02	8,5 cm	12,5 cm	0,6 l
89143-03	8,5 cm	5 cm	0,25 l
89143-04	10 cm	10 cm	0,75 l
89143-05	10 cm	5 cm	0,35 l
89143-06	12 cm	12 cm	1,25 l
89143-07	15 cm	15 cm	2,5 l
89143-08	15 cm	10 cm	1,75 l
89143-09	20 cm	20 cm	6 l
89143-10	20 cm	10 cm	3 l



89147-10 100 cc
 89147-25 250 cc



89148-25 25 cc
 89148-50 50 cc



89150-30
 90 x 80 mm

Sputumbecher
 Sputum Cup
 Escupidera
 Sputacchiera

Spirituslampen
 Spirit lamps
 Lâmparas de alcohol
 Lampade a spirito



89278-01
 120 ccm



89278-02
 120 ccm



89278-03
 120 ccm

Lagerungstray
Storage Tray
Tray para depositar
Bacinelle per il deposito



89259-05

für 5 instrumente
for 5 instruments
para 5 instrumentos
per 5 strumenti



89259-10

für 10 instrumente
for 10 instruments
para 10 instrumentos
per 10 strumenti



89259-20

für 20 instrumente
for 20 instruments
para 20 instrumentos
per 20 strumenti

Container
Containers
Contenedores
Container

Deckel gelocht
Boden ungelocht

Perforated lid
Unperforated bottom

Tapa perforada
Cuerpo sin perforación

Coperchio con filtro
Fondo senza filtro



310 x 190 x 40 mm **R 510.04**

Deckel gelocht
Perforated lid
Tapa perforada
Coperchio con filtro



310 x 190 x 40 mm **R 500.01**

Deckel gelocht
Boden ungelocht

Perforated lid
Unperforated bottom

Tapa perforada
Cuerpo sin perforación

Coperchio con filtro
Fondo senza filtro



310 x 190 x 65 mm **R 510.06**

Boden ungelocht
Unperforated bottom
Cuerpo sin perforación
Fondo senza filtro



310 x 190 x 40 mm **R 505.04**
310 x 190 x 65 mm **R 505.06**
310 x 190 x 130 mm **R 505.13**

Deckel gelocht
Boden ungelocht

Perforated lid
Unperforated bottom

Tapa perforada
Cuerpo sin perforación

Coperchio con filtro
Fondo senza filtro



310 x 190 x 130 mm **R 510.13**

Silikon - Noppenmatte
Silicon mat
Colchón de silicona
Tappetto in silicone



260 x 180 mm **R 850.10**

Spannrahmen für Einschlagtücher
Tension clips for towels
Marcos tensores para paños
Telaio di fissaggio



277 x 175 mm **R 595.00**

Tuch
Drape
Paño
Panno



60 x 40 cm **R 095.01**
65 x 65 cm **R 095.02**
85 x 85 cm **R 095.03**

03

03340-15 1
 03340-20 1
 03360-21 1
 03361-10 1
 03362-10 1

05

05180-15 31
 05180-17 31
 05180-20 31
 05180-25 31
 05180-35 31

07

07103-00 3
 07104-00 3
 07106-01 3
 07106-02 3
 07107-00 3
 07107-01 3
 07109-10 4
 07109-13 4
 07109-15 4
 07110-00 5
 07111-00 5
 07112-00 5
 07113-00 5
 07115-00 5
 07116-00 5
 07118-00 5
 07119-00 5
 07120-00 5
 07121-00 5
 07122-00 5
 07123-00 5
 07124-00 5
 07125-00 5
 07130-00 5
 07161-00 4
 07162-00 4
 07165-00 4
 07167-00 4
 07404-01 4
 07404-02 4
 07404-03 4

09

09102-14 6
 09102-15 6

09102-16 6
 09102-18 6
 09103-14 6
 09103-15 6
 09103-16 6
 09103-18 6
 09104-14 6
 09105-14 6
 09110-14 6
 09110-15 6
 09110-16 6
 09110-18 6
 09111-14 6
 09111-15 6
 09111-16 6
 09111-18 6
 09114-14 6
 09115-14 6
 09120-14 6
 09120-15 6
 09120-16 6
 09120-18 6
 09121-14 6
 09121-15 6
 09121-16 6
 09121-18 6
 09124-14 6
 09125-14 6
 09190-16 8
 09191-16 8
 09194-16 8
 09195-16 8
 09280-12 7
 09280-15 7
 09280-18 7
 09281-12 7
 09281-15 7
 09281-18 7
 09282-15 7
 09282-18 7
 09283-15 7
 09283-18 7
 09284-12 7
 09284-15 7
 09284-18 7
 09285-12 7
 09285-15 7
 09285-18 7
 09286-15 7
 09286-18 7
 09287-15 7

09287-18 7
 09304-14 8
 09304-14TC 8
 09305-14 8
 09305-14TC 8
 09340-09 8
 09340-10 8
 09340-11 8
 09341-09 8
 09341-10 8
 09341-11 8
 09344-11 8
 09345-11 8
 09360-11 8
 09361-11 8
 09362-11 8
 09363-11 8
 09425-17 9
 09427-17 9
 09540-16 8
 09541-16 8
 09542-16 8
 09543-16 8
 09610-18 9
 09610-18TC 9
 09611-18 9
 09611-18TC 9
 09802-09 9
 09802-11 9
 09803-09 9
 09803-13 9
 09804-14 9
 09820-13 10
 09820-13TC 10
 09821-13 10
 09821-13TC 10
 09823-12 10
 09824-12 10
 09825-12 10
 09826-12 10
 09828-12 10
 09829-12 10
 09831-12 9,124
 09835-12 9,124
 09850-10 124
 09851-10 124
 09854-11 10
 09859-16 10
 09860-16 10
 09861-16 10

11

11102-14 11
 11102-16 11
 11102-18 11
 11110-14 11
 11110-16 11
 11110-18 11
 11120-14 11
 11120-16 11
 11120-18 11
 11130-14 11
 11130-16 11
 11130-18 11
 11170-12 12
 11170-15 12
 11176-12 12
 11176-15 12
 11180-12 12
 11180-15 12
 11181-12 12
 11181-15 12
 11186-12 12
 11186-15 12
 11188-12 12
 11189-12 12
 11260-12 11
 11260-15 11
 11261-15 11
 11270-12 11
 11270-15 11
 11271-15 11
 11272-15 11
 11273-15 11
 11314-01 11
 11314-02 11
 11821-11 13
 11822-13 13
 11823-13 13
 11828-15 13
 11900-01 13
 11901-05 13
 11910-01 13

13

13210-10 14
 13211-10 14
 13212-10 14
 13213-10 14
 13220-12 14
 13220-14 14

13221-12 14
 13221-14 14
 13230-12 14
 13230-14 14
 13231-12 14
 13231-14 14
 13310-13 15
 13310-14 15
 13310-16 15
 13311-13 15
 13311-14 15
 13311-16 15
 13320-13 15
 13320-14 15
 13320-16 15
 13321-13 15
 13321-14 15
 13321-16 15
 13368-14 15
 13368-16 15
 13380-15 15
 13381-15 15
 13382-15 15
 13383-15 15
 13410-18 16
 13411-18 16
 13475-18 16

15

15101-09 16
 15103-07 16
 15103-09 16
 15111-09 16
 15111-11 16
 15111-13 16
 15111-15 16
 15123-11 16
 15123-13 16

17

17110-20 17
 17110-25 17
 17111-20 17
 17111-25 17
 17170-18 17
 17170-20 17
 17170-25 17
 17171-18 17
 17171-20 17
 17171-25 17

19

19102-12 19
 19102-15 19
 19122-13 19
 19210-12 18
 19211-12 18
 19212-01 18
 19212-02 18
 19214-13 18
 19214-18 18
 19215-13 18
 19215-18 18
 19216-01 18
 19216-02 18
 19216-05 18
 19216-07 18
 19216-10 18
 19220-01 19
 19220-02 19
 19220-03 19
 19220-04 19
 19221-01 19
 19221-02 19
 19221-03 19
 19221-04 19
 19230-10 18
 19230-12 18
 19230-14 18
 19230-16 18
 19230-18 18
 19240-10 18
 19240-20 18
 19312-01 20
 19312-02 20
 19312-03 20
 19312-04 20
 19312-05 20
 19314-07 20
 19314-10 20
 19314-12 20
 19314-14 20
 19314-15 20
 19314-16 20
 19314-20 20
 19315-06 20
 19330-40 20
 19330-55 20
 19348-22 20

21

21104-11 23

21104-13 23
 21104-14 23
 21104-16 23
 21104-18 23
 21104-20 23
 21104-25 23
 21105-11 23
 21105-13 23
 21105-14 23
 21105-16 23
 21105-18 23
 21105-20 23
 21105-25 23
 21106-11 23
 21106-13 23
 21106-14 23
 21106-16 23
 21106-18 23
 21106-20 23
 21106-25 23
 21270-12 23
 21270-14 23
 21270-16 23
 21270-18 23
 21270-23 23

25

25110-12 24
 25114-12 24
 25128-13 24
 25129-13 24
 25130-13 24
 25134-13 24
 25140-13 24
 25144-13 24
 25150-12 24
 25150-14 24
 25154-12 24
 25154-14 24
 25160-15 24
 25160-18 24
 25164-15 24
 25164-18 24
 25170-15 24
 25174-15 24
 25180-14 25
 25180-16 25
 25180-18 25
 25180-20 25
 25184-14 25
 25184-16 25

29

29110-27 136
 29140-20 136
 29140-30 136
 29145-55 136
 29150-12 136
 29152-14 136
 29201-03 137
 29203-03 137
 29204-07 137
 29205-08 137
 29205-12 137
 29206-13 137
 29207-15 137
 29208-20 137
 29208-25 137
 29208-30 137

25184-18 25
 25184-20 25
 25190-16 25
 25190-18 25
 25194-16 25
 25194-18 25
 25214-16 25
 25214-18 25
 25214-20 25
 25450-14 25
 25450-17 25
 25450-20 25
 25452-14 25
 25452-17 25
 25452-20 25
 25466-20 25
 25467-20 25
 25668-18 25
 25670-14 25
 25671-14 25
 25672-14 25
 25673-14 25
 25674-14 25
 25675-14 25
 25676-14 25
 25677-14 25
 25691-18 25

29

29110-27 136
 29140-20 136
 29140-30 136
 29145-55 136
 29150-12 136
 29152-14 136
 29201-03 137
 29203-03 137
 29204-07 137
 29205-08 137
 29205-12 137
 29206-13 137
 29207-15 137
 29208-20 137
 29208-25 137
 29208-30 137

33

33101-12 29
 33101-14 29
 33103-14 29
 33105-17 29

33131-15 29
 33133-15 29
 33201-18 29
 33202-18 29
 33205-18 30
 33211-15 30
 33213-15 30
 33216-18 30
 33217-18 30
 33280-15 30
 33281-15 30
 33469-96 26
 33469-97 26
 33469-98 26
 33470-00 26
 33496-00 26
 33496-01 26
 33496-12 26
 33620-02 27
 33620-03 27
 33620-04 27
 33620-05 27
 33620-06 27
 33620-07 27
 33620-08 27
 33622-02 27
 33622-03 27
 33622-04 27
 33622-05 27
 33622-06 27
 33622-07 27
 33622-08 27
 33623-02 27
 33623-03 27
 33623-04 27
 33623-05 27
 33623-06 27
 33623-07 27
 33623-08 27
 33625-02 27
 33625-03 27
 33625-04 27
 33625-05 27
 33625-06 27
 33625-07 27
 33625-08 27
 33652-02 27
 33652-03 27
 33652-04 27
 33652-06 27
 33652-08 27

33652-10 27
 33652-12 27
 33652-15 27
 33654-02 27
 33654-03 27
 33654-04 27
 33654-06 27
 33654-08 27
 33654-10 27
 33654-12 27
 33654-15 27
 33691-34 27
 33693-32 27
 33693-33 27
 33693-34 27
 33711-16 28
 33712-16 28
 33713-16 28
 33713-17 28
 33716-18 28

34

34480-01 32
 34480-02 32
 34480-03 32
 34536-14 126
 34538-01 126
 34538-02 126
 34538-03 126
 34539-01 126
 34539-02 126
 34539-03 126
 34540-16 124
 34540-18 126
 34542-15 124
 34546-16 124
 34546-18 124
 34548-18 124
 34549-14 125
 34554-15 126

41

41295-06 31
 41295-07 31
 41295-08 31
 41295-09 31
 41295-10 31
 41295-11 31
 41295-12 31
 41295-15 31
 41297-06 31

41297-0731
 41297-0831
 41297-0931
 41297-1031
 41297-11.....31
 41297-1231

43

43583-062
 43583-072
 43583-082
 43583-092
 43583-182
 43584-182
 43613-0023
 43614-0023
 43614-0123
 43614-1223
 43614-2323
 43614-3423
 43614-4523
 43614-5623
 43614-6723
 43614-7823

45

45098-0173
 45098-0273
 45098-0573
 45098-1073
 45098-2073
 45098-5073
 45099-0173
 45099-0273
 45099-0573
 45099-1073
 45099-2073
 45099-5073

47

47303-0330
 47303-0430
 47303-0530
 47303-0630
 47451-80132
 47521-0126
 47521-0226
 47521-0326
 47560-1818
 47562-1818

49

49102-1633
 49107-1933
 49108-1533
 49111-15.....33
 49115-01.....33
 49115-02.....33
 49119-14.....34
 49230-11.....34
 49231-1234
 49231-1434
 49231-1634
 49232-1535
 49232-2135
 49232-2635
 49235-1934
 49250-1634
 49250-1834
 49255-1634
 49265-1236
 49265-1436
 49267-1236
 49270-1636
 49270-1936
 49272-1336
 49274-0936
 49274-11.....36
 49274-1336
 49274-1536
 49310-0037
 49310-0137
 49310-0237
 49310-0337
 49310-0437
 49310-0537
 49310-0837
 49310-1037
 49310-1237
 49317-0038
 49317-0138
 49317-0238
 49317-0338
 49317-1038
 49320-0039
 49320-0139
 49320-0239
 49320-0339
 49320-1039
 49320-2039
 49360-1032

49400-0139
 49605-0721
 49605-1021
 49605-11.....21
 49605-1221
 49605-1421
 49605-1621
 49610-1221
 49610-1321
 49610-1621
 49613-1022
 49615-1222
 49620-1522
 49627-0128
 49630-0228

51

51150-19.....23
 51151-19.....23

53

53270-0875
 53270-1075
 53270-1275
 53270-1475
 53270-1675
 53270-1875
 53270-2075
 53270-2275
 53270-2475
 53270-2675
 53270-2875
 53270-3075
 53272-0875
 53272-1075
 53272-1275
 53272-1475
 53272-1675
 53272-1875
 53272-2075
 53272-2275
 53272-2475
 53272-2675
 53272-2875
 53272-3075

65

65102-1217
 65110-15.....17
 65120-1517

65120-1917
 65160-1617
 65168-1617

75

75103-1518
 75301-1040
 75304-1040
 75305-1040
 75373-1040
 75382-1640
 75396-0141
 75396-0241
 75397-0041
 75450-1340
 75460-1340
 75630-1240

87

87000-0142
 87000-0242
 87000-0442
 87000-0742
 87000-1342
 87000-1743
 87000-1843
 87000-18A43
 87000-2243
 87000-2343
 87000-2443
 87000-2943
 87000-3344
 87000-33A44
 87000-33C44
 87000-33M44
 87000-34N44
 87000-35N44
 87000-3644
 87000-46L45
 87000-46LX45
 87000-46N45
 87000-4945
 87000-5145
 87000-51A45
 87000-51C45
 87000-6746
 87000-67A46
 87000-67N46
 87000-7346
 87000-7446

87000-74N.....46
 87000-74NX ..46
 87000-7547
 87000-7647
 87000-76N.....47
 87000-7947
 87000-79A.....47
 87000-79N.....47
 87000-86A48
 87000-86B48
 87000-86C.....48
 87000-9748
 87001-3348
 87001-4648
 87001-5149
 87001-5349
 87002-3349
 87010-13S50
 87010-22S50
 87010-3050
 87010-33S50
 87010-3750
 87010-3850
 87010-3950
 87010-39A.....51
 87010-39L51
 87010-39R.....51
 87010-4051
 87010-51S51
 87010-76S51
 87020-0352
 87020-0552
 87020-0652
 87020-0752
 87020-51S52
 87021-3752
 87021-3952
 87100-0153
 87100-01A53
 87100-10S53
 87100-1553
 87100-1653
 87100-16S53
 87100-1754
 87100-18L54
 87100-18R.....54
 87100-2354
 87100-3254
 87100-32A54
 87100-53L55
 87100-53R.....55

87100-6255	87211-02.....61	87233-2365	87315-0174	87420-0880
87100-6555	87211-03.....61	87233-7065	87315-0274	87420-0980
87100-6955	87212-0162	87233-7165	87315-0374	87420-1080
87100-88L56	87212-2L62	87240-0166	87315-11.....74	87420-11.....80
87100-88R56	87212-2R.....62	87241-0167	87315-1274	87421-01L80
87101-5056	87213-0162	87241-0267	87315-1374	87421-02R.....80
87101-50AS...56	87213-0262	87242-0167	87400-0176	87421-1280
87101-50H.....56	87213-03L62	87242-0267	87400-0276	87422-0180
87101-50S56	87213-03R.....62	87243-0168	87400-0376	87422-0280
87101-50X57	87214-0161	87243-0268	87400-3276	87422-12B.....80
87101-5157	87214-0361	87243-0368	87400-3376	87425-0181
87101-51A57	87220-0063	87244-0168	87400-3476	87425-0281
87101-51AS...57	87220-00A.....63	87244-0268	87400-3576	87425-0381
87101-51S57	87220-0163	87244-0368	87400-3676	87425-0481
87101-51X.....57	87220-01A.....63	87245-0168	87401-3376	87425-3681
87102-2257	87220-0263	87245-0268	87402-3376	87426-0181
87105-0158	87220-02A.....63	87245-0368	87402-3476	87426-0281
87105-0258	87221-0063	87248-0169	87402-3576	87426-0381
87110-17.....59	87221-00A.....63	87248-0269	87403-3376	87427-0482
87110-23.....59	87221-0163	87248-0369	87403-3476	87427-0882
87111-50.....59	87221-01A.....63	87249-0169	87404-3476	87427-1482
87111-51.....59	87221-0263	87249-0269	87406-1377	87427-1882
87200-01L60	87221-02A.....63	87249-0369	87406-1477	87428-0382
87200-01R.....60	87222-0063	87270-0070	87406-1777	87428-0582
87200-0360	87222-0163	87270-11.....70	87407-0277	87428-11.....82
87200-03A60	87222-0263	87270-2270	87407-0377	87428-1282
87200-04L60	87224-0164	87270-3370	87407-0577	87429-0182
87200-04R.....60	87224-01A.....64	87270-4470	87407-0677	87429-0282
87200-0660	87224-0264	87272-0071	87407-1577	87430-0283
87200-0860	87224-02A.....64	87272-11.....71	87407-2377	87430-0483
87200-0960	87224-0364	87272-2271	87408-0677	87430-1383
87200-1060	87224-03A.....64	87272-3371	87408-0777	87431-0483
87200-11.....60	87224-0464	87274-0071	87411-35.....78	87432-0183
87200-1260	87224-04A.....64	87274-0171	87412-0478	87432-0383
87200-22S60	87226-0164	87274-0271	87412-04S.....78	87432-0583
87200-2761	87226-01A.....64	87274-0371	87412-04SD ..78	87433-1783
87200-2861	87226-0264	87274-0471	87414-3278	87435-0184
87200-3460	87226-02A.....64	87300-1872	87414-3378	87435-0384
87200-34S60	87226-0364	87300-2272	87414-3578	87435-0584
87200-3961	87226-03A.....64	87301-1872	87416-0179	87435-0784
87200-4061	87226-0464	87301-2272	87416-0279	87435-0984
87200-4660	87226-04A.....64	87302-0072	87416-0379	87435-11.....84
87200-46R.....61	87230-11L.....66	87302-1072	87416-0479	87435-1384
87203-0161	87230-11R.....66	87310-0474	87416-0579	87435-1584
87203-0261	87230-13L66	87310-0574	87416-0679	87435-1784
87203-0361	87230-13R.....66	87311-04.....74	87418-0179	87436-0185
87203-0461	87230-14L66	87311-05.....74	87418-0279	87436-0385
87210-0161	87230-14R.....66	87312-0474	87418-0379	87436-0585
87210-02L61	87233-2065	87312-0574	87418-0579	87436-0785
87210-03R.....61	87233-2165	87313-0474	87418-12B79	87436-0985
87211-01.....61	87233-2265	87313-0574	87420-0780	87436-11.....85

87436-1385	87446-1290	87460-3994	87503-0299	87515-02102
87436-1585	87450-0391	87460-6295	87503-0399	87515-03102
87436-1785	87450-03A91	87460-6495	87503-0499	87515-04102
87437-0186	87450-0691	87460-6695	87503-0599	87516-01S...102
87437-0386	87450-06XL...91	87461-2694	87503-1099	87517-00102
87437-0586	87450-08A91	87461-2894	87504-0199	87517-01102
87437-0786	87450-0991	87461-3094	87504-0299	87517-02102
87437-0986	87450-1291	87461-3494	87504-0399	87517-03102
87437-1186	87450-1791	87461-5494	87504-0499	87520-01103
87437-1386	87450-2391	87462-0194	87504-0599	87520-02103
87437-1586	87451-0391	87462-0294	87504-0699	87520-03103
87437-1786	87451-03A91	87462-0394	87505-0199	87521-01103
87439-0187	87451-0691	87464-0196	87505-0299	87521-02103
87439-0287	87451-06XL...91	87464-0296	87505-0399	87521-03103
87439-0387	87451-08A91	87464-2696	87505-0499	87522-02103
87439-0487	87451-0991	87464-2796	87508-00100	87522-03103
87439-0587	87451-1291	87464-2896	87508-01100	87524-01103
87439-1287	87451-1791	87464-2996	87508-02100	87524-02103
87439-4087	87451-2391	87464-5296	87509-27100	87526-07A...103
87440-0888	87451-5491	87464-5496	87509-28100	87526-07B...103
87440-1088	87453-0192	87464-6496	87510-01100	87526-19103
87440-1188	87453-0292	87464-6696	87510-02100	87530-01104
87440-26G.....88	87453-0392	87464-7896	87510-03100	87530-02104
87441-0088	87453-0692	87464-8096	87510-04100	87530-03104
87441-0188	87453-1692	87470-3097	87510-05100	87530-11104
87441-0288	87453-1792	87470-4097	87510-18100	87530-12104
87441-0488	87453-17A92	87470-5097	87510-26100	87530-13104
87441-0888	87453-3692	87470-6097	87511-01101	87531-01104
87441-0988	87454-0192	87470-9097	87511-01S ...101	87531-02104
87442-1188	87454-0292	87471-0097	87511-02101	87531-03104
87442-1288	87454-0592	87471-2097	87511-02S ...101	87531-10104
87442-12S88	87454-1692	87472-0197	87511-03101	87531-11104
87442-1588	87460-0093	87472-0297	87511-03S ...101	87531-12104
87442-2288	87460-0193	87472-0397	87512-01P ...101	87531-13104
87444-2089	87460-01A93	87472-2097	87512-01S ...101	87532-06104
87444-3089	87460-0293	87472-3097	87512-02P ...101	87532-11104
87444-3189	87460-02A93	87472-4097	87512-02S ...101	87532-79104
87444-3289	87460-0393	87472-5097	87512-03P ...101	87534-01105
87444-6089	87460-0493	87472-6097	87512-03S ...101	87534-01A...105
87444-6189	87460-0693	87500-0198	87512-04P ...101	87534-01B...105
87444-6289	87460-1494	87500-0298	87512-04S ...101	87534-01C...105
87444-7089	87460-1795	87500-0998	87513-01102	87534-02105
87444-7189	87460-17S95	87500-5198	87513-02102	87534-02A...105
87444-7289	87460-17W95	87500-5298	87513-03102	87534-02B...105
87445-0090	87460-1895	87501-0098	87514-01102	87534-02C...105
87445-0190	87460-18W95	87501-0998	87514-02102	87534-03105
87445-0290	87460-1995	87501-1198	87514-03102	87534-03A...105
87445-1190	87460-19W95	87501-2998	87514-04102	87537-00106
87445-1290	87460-31L95	87502-0198	87514-05102	87538-00106
87446-1090	87460-32L95	87502-0298	87514-06102	87538-01106
87446-1190	87460-33L95	87503-0199	87515-01102	87538-02106

87538-03 106	87601-03 110	87619-01 114	87680-00 121	87811-05..... 134
87538-04 106	87601-04 110	87619-02 114	87684-00 122	87811-09..... 134
87539-02 106	87602-01 110	87619-03 114	87685-01 122	87820-02 133
87540-01 107	87602-02 110	87630-01 115	87685-02 122	87820-04 133
87540-12 107	87602-03 110	87630-02 115	87685-11..... 122	87820-06 133
87540-12A... 107	87603-01 110	87632-17 115	87685-12 122	87820-08 133
87541-01 107	87603-02 110	87634-10 115	87685-13 122	87820-10 133
87541-02 107	87603-03 110	87634-20 115	87690-13 123	87820-12 133
87541-03 107	87604-01 111	87640-01 116	87692-00 123	87854-01 135
87541-04 107	87604-02 111	87640-02 116	87692-01 123	87854-02 135
87541-05 107	87604-03 111	87640-03 116	87692-13 123	87854-03 135
87541-06 107	87605-01 111	87640-04 116	87720-12 125	87854-04 135
87542-00 107	87605-02 111	87640-05 116	87721-11..... 125	87854-05 135
87542-01 107	87605-03 111	87641-01 116	87722-11..... 125	87854-06 135
87543-01 107	87606-01 111	87641-02 116	87723-12 125	87854-07 135
87543-13 107	87606-02 111	87641-04 116	87725-00 125	
87544-07 107	87606-03 111	87642-01 117	87726-00 125	89
87544-08 107	87608-01 114	87642-03 117	87731-14 126	89111-25..... 138
87544-09 107	87608-02 114	87642-03S... 117	87732-13 127	89111-32..... 138
87544-10 107	87608-03 114	87643-01 117	87733-13 127	89112-65..... 138
87544-11..... 107	87609-01 114	87643-01S... 117	87733-14 127	89113-65..... 138
87544-12 107	87609-02 114	87643-02 117	87734-15 127	89114-00..... 138
87544-13 107	87609-03 114	87644-01 117	87735-13 127	89115-50..... 138
87545-05 107	87610-00 112	87644-02 117	87736-01 127	89115-65..... 138
87545-06 107	87610-01 112	87644-03 117	87736-02 127	89115-75..... 138
87545-07 107	87610-02 112	87645-01 117	87736-03 127	89116-50..... 138
87546-05 107	87610-03 112	87645-03 117	87738-12 128	89116-65..... 138
87546-06 107	87610-04 112	87646-01 118	87739-14 128	89116-75..... 138
87546-07 107	87611-00..... 112	87646-02 118	87740-12 128	89121-40 139
87550-16 108	87611-01..... 112	87647-00 118	87741-12 128	89121-50 139
87551-15 108	87611-02..... 112	87647-03 118	87742-14 128	89122-16 139
87552-16 108	87611-03..... 112	87648-08 118	87743-12 128	89122-21 139
87553-17 108	87611-04..... 112	87648-18 118	87744-12 129	89122-26 139
87554-17 108	87612-01 112	87650-00 118	87746-01 129	89122-30 139
87560-60 109	87612-02 112	87650-05 118	87746-02 129	89124-23 140
87561-26 109	87612-03 112	87650-06 118	87746-03 129	89124-26 140
87561-27 109	87613-01 112	87650-07 118	87747-13 129	89124-27 140
87561-28 109	87613-02 112	87650-92 118	87748-13 129	89124-30 140
87561-29 109	87613-03 112	87651-10 118	87749-11..... 129	89124-32 140
87561-30 109	87614-01 113	87654-01 119	87749-13 129	89124-42 140
87561-31 109	87614-02 113	87654-02 119	87750-15 130	89125-23 140
87561-51 109	87614-03 113	87654-10 119	87751-15 130	89125-26 140
87561-60 109	87615-01 113	87654-20 119	87752-15 130	89125-27 140
87600-00 110	87615-02 113	87660-15 120	87754-14 131	89125-30 140
87600-01 110	87615-03 113	87661-17 120	87755-14 131	89125-32 140
87600-02 110	87616-01 113	87662-13 120	87756-13 131	89125-42 140
87600-03 110	87616-02 113	87662-17 120	87757-13 131	89126-23 140
87600-04 110	87616-03 113	87665-15 120	87758-13 131	89126-26 140
87601-00 110	87618-01 114	87666-15 120	87810-00 132	89126-27 140
87601-01 110	87618-02 114	87670-00 121	87811-00..... 134	89126-30 140
87601-02 110	87618-03 114	87671-00 121	87811-01..... 134	

89126-32	140	89145-30	142
89126-42	140	89145-31	142
89127-04	141	89145-35	142
89127-06	141	89146-20	143
89127-08	141	89147-10	143
89127-11	141	89147-21	142
89127-12	141	89147-24	142
89127-14	141	89147-25	143
89127-16	141	89147-30	142
89127-18	141	89147-31	142
89127-23	140	89147-35	142
89127-26	140	89147-40	142
89127-27	140	89147-42	142
89127-30	140	89148-25	143
89127-32	140	89148-50	143
89127-42	140	89150-30	143
89129-11	141	89259-05	144
89133-16	141	89259-10	144
89133-17	141	89259-20	144
89133-22	141	89270-15	2
89133-24	141	89271-15	2
89133-31	141	89278-01	143
89133-34	141	89278-02	143
89133-38	141	89278-03	143
89139-17	141		
89139-25	141		
89139-27	141		
89140-02	142		
89140-05	142		
89140-10	142		
89140-20	142		
89141-10	142		
89142-01	142		
89142-02	142		
89142-03	142		
89142-04	142		
89142-05	142		
89142-06	142		
89142-07	142		
89143-00	143		
89143-01	143		
89143-02	143		
89143-03	143		
89143-04	143		
89143-05	143		
89143-06	143		
89143-07	143		
89143-08	143		
89143-09	143		
89143-10	143		
89145-23	142		

R

R 095.01	145
R 095.02	145
R 095.03	145
R 500.01	145
R 505.04	145
R 505.06	145
R 505.13	145
R 510.04	145
R 510.06	145
R 510.13	145
R 595.00	145
R 850.10	145

A

Abdrucklöffel 110-114
 Abdrucklöffel für bezahnte 110, 112
 Abdrucklöffel für Funktionsabdrücke 112-113
 Abdrucklöffel für partielle Abdrücke ... 114
 Abdrucklöffel für partiell bezahnte 110, 112
 Abdrucklöffel für unbezahnte 111-113
 ABELL Konturenzange 131
 ADAMS Technikzange 129
 ADERER Bandentfernungs- zange 128
 ADERER Konturenzange 129
 ADSON Anatomische Pinzetten 12
 ADSON Arterienklemmen 16
 AINSWORTH
 Kofferdam-Lochzange 108
 ALLIS Darm- und Gewebefasszangen 17
 ALLIS-BABY Darm- und Gewebefasszangen 17
 Amalgam-Fingerbecher 98
 Amalgampistole 98
 Ampullenspritze 72
 Anatomische und chirurgische Pinzetten 11-12
 ANGLE Drahtbiegezange 128
 APICAL Luxator 64
 APICAL Wurzelheber 61
 Arterienklemmen 14-16
 ASH Zahnfleischmesser 4

B

BABCOCK Atrauma Darm- und Gewebefasszangen 17
 BACKHAUS Tuchklemmen 16
 BALL AND SOCKET Tuchklemmen 16
 Bandentfernungs- zange 128
 BARRY Wurzelheber 65
 BAUMGARTNER Nadelhalter 24
 BEALE Modellierinstrument 119
 Becher 143
 BEEBEE Drahtschere 124
 BEIN Luxator 64
 BEIN Wurzelheber 63
 Bereitschaftskästen 140
 BEYER Hohlmeißelzangen 29
 BLACK Schmelzmeißel 96
 BÖHLER Hohlmeißelzangen 30
 BÖHLER Knochensplitterzangen 30
 BOLEY Schieblehre 1

BOWMAN Knopfsonde 23
 BREWER Kofferdam Klammerzange 108
 BRIAULT Zahnsonden 90
 Brückenabnehmzangen 130
 BRUENINGS Zungendrucker 33
 Bügelbiegezange 129
 BUNT Sterilisierklammern 136
 Bürstenspender 41

C

CASTROVIEJO Mikro-Nadelhalter 25
 CASTROVIEJO Schieblehre 2
 CASTROVIEJO-EPKER Schieblehre 2
 CAWOOD-MINNESOTA Zungendrucker 33
 CHEATTLE Sterilisierzangen 136
 Chirurgische Küretten 70-71
 Chirurgische Pinzetten 11-12
 Chirurgische Scheren 6, 8
 CHOMPRET Wurzelspitzenheber 68
 Container 145
 Cleoid-Discoïd Modellierinst 118
 CLEVELAND Hohlmeißelzangen 29
 COLEMAN Wurzelheber 61
 COLLIN Zungenzangen 34
 COLUMBIA Kürette 83
 COUPLAND Saugrohre 31
 COUPLAND Wurzelheber 61
 CRANE-KAPLAN Scaler 79
 CRILE-MURRAY Nadelhalter 24
 CRILE-WOOD Nadelhalter 24
 CROSS Zahnsonden 90
 CROWN-BUTLER Kronenabnehmer 122
 CRYER Wurzelheber 60-61
 CRYER Zahnzange 56-57
 CUMINE Scaler 76

D

Darm- und Gewebefasszangen 17
 DAVIS-BOYLE Mundsperrerr 37
 DE BAKEY Nadelhalter 25
 DEAN Tonsillenschere 9
 DENHART Mundsperrerr 36
 DERF Nadelhalter 24
 DESMARRÉS Sattelhäkchen 18
 DIAMANT Teleskopkronenzange 123
 Diamanteinsätze für Teleskopkronenzange 123

DINGMANN Mundsperrerr 38
 Distalschneider 125
 Dose 142
 DOYEN-JANSEN (MOLT) Mundsperrerr 36
 Drahtbiegezange 128
 Drahtfaßzangen 126
 Drahtkneifzangen 124
 Drahtschneidezange 125
 DUMONT Flachzange 127

E

Einsatz für Crown-Butler 122
 Elefantenfußstopfer 100
 Ersatzklinge zu Knochenschaber 134
 Exkavator 93-95

F

Fadenschere 9
 Fadenstopfer 115
 FAHNENSTOCK Gipsmesser 120
 FARABEUF Wundhaken 19
 FARRELL Watteträger 23
 FEDI Parodontalmeißel 81
 Feine Schere 10
 FELT Kompositinstrument 99
 Flachzange 126-127
 FLOHR Wurzelheber 60-61
 FOERSTER Schwammzange 17
 FRAHM Modellierinstrument 117
 FRAZIER Hauthäkchen 18
 FRAZIER/FERGUSON Saugrohre 31
 FRIEDMAN Hohlmeißelzangen 29
 FRIEDMAN Mini Hohlmeißelzangen 29
 FRIEDMAN Wurzelheber 62
 Füllungsinstrumente 100
 Furkationskürette 87
 FURRER Brückenabnehmzangen 130

G

Gewebefasszangen 17
 GILLIES Chirurgische Pinzetten 11
 GILLIES Hauthäkchen 18
 Gingivektomiemesser 80
 GISY-WILD Wachsmesser 120
 GOLDMAN-FOX
 Gingivektomiemesser 80
 GOLDMAN-FOX Parodontometer 88-90
 GOLDMAN-FOX Scaler 79
 GOLDMAN-FOX

Zahnfleischscheren	10
GOLDSTEIN Kompositinstrument	99
GOSLEE Konturenzange	127
GRACEY (MINI) Kürette.....	85
GRACEY (RIGID) Kürette	86
GRACEY Kürette.....	84
GRAEFE Hauthäkchen.....	18
GREEN Wundhaken.....	20
GRITMANN Gipsmesser	120
GROSS-MAIER Tupfer- und Kornzangen	17
GUTHRIE Hauthäkchen	18

H

HALSTED-MOSQUITO	
Arterienklemmen	14
HALSEY Nadelhalter	24
Hämmer.....	27
Handwaschbürsten.....	41
HARRIS Zahnzange	54
HARTMANN Arterienklemmen	14
HARTMANN Zungendrücker	33
HEIDEBRINK Wurzelspitzenheber	69
HEISTER Mundsperrerr.....	36
HEMINGWAY Scharfe Doppellöffel	70
HENAHAN Zahnzange	53
HIRSCHFELD Knochenfeile.....	82
Hohlmeißelzangen.....	29-30
HOLLENBACK Modellierinstrument ..	117
HOLLENBACK Plugger	102
HOW Kronenzangen	131
HYGIENIST Scaler	77
HYLIN Modellierinstrument.....	119
HYLIN Wurzelheber.....	62
Inbusschlüssel für Teleskopkronenzange.....	123

I

Injektionsspritze	73
Instrumentenkästen	139
IRIS Chirurgische Scheren	8
IVORY Kofferdam-Klammer	109
IVORY Kofferdam-Klammerzange.....	108
IVORY Matrizenspanner.....	107
IWANSON Schieblehre	2

J

JAQUETTE Scaler.....	76, 78
JENNINGS Mundsperrerr	36
JOHNSON Konturenzange.....	131
JONES Tuchklemmen	16

JOSEPH Hauthäkchen	18
JOSEPH Präparierscheren.....	8

K

Kanüle Luer Lock.....	72
Kappenzangen	138
Kehlkopfspiegel	75
KELLY Präparierscheren	8
KERRISON Kieferhöhlenstanze	30
KILNER Hauthäkchen	18
Kinderzahnzange.....	59
KIRKLAND Gingivektomiemesser	80
KLEIN Kinderzahnzange	52
Knochenmühle.....	132
Knochenquetscher.....	132
Knochenschaber.....	134
Knochenfeilen.....	82
Knopfsonde	23
KOCHER-LANGENBECK	
Wundhaken	20
Kofferdam-Instrumente.....	108-109
Kofferdam-Klammer	109
Kompositinstrument.....	98-99
Konturenzange	127, 131
KRALLENHEBER Wurzelheber	67
KRAMERS Sinus-Lift Kürette	135
Kronenaufbieger	121
Kroneninstrumente	122-123
Kronensetzer	121
Kugelstopfer	100
Kugelstopfer/Spatel	105
Kunststoffansatz zu Amalgampistole	98
Küretten	83-87

L

LA GRANGE Zahnfleischscheren.....	10
LADMORE Stopfer	103
LANGENBECK Fingerschützer	32
LANGENBECK Wundhaken.....	20
LANGER Kürette	83
LAWRENCE-READ Zahnzange	47, 51
Lagerungstray.....	144
Le CRON Modellierinstrument.....	119
LECLUSE Wurzelheber	66
LERICHE Arterienklemmen	15
LEXER Präparierscheren	8
LICHTENBERG Nadelhalter.....	25
LICHTENSTEIN Spatel	115
LINDO-LEVIAN Wurzelheber	61
Lippen- und Wangenhalter	35

LITTAUER Fadenscheren	9
LOCKLIN Zahnfleischscheren	10
LONDON-COLLEGE Zahnpinzetten ..	13
LUCAS Chirurgische Küretten.....	71
LUER Hohlmeißelzangen	29
LUNIATSCHEK Tamponstopfer	23
Luxatoren.....	64

M

MARKLEY Plugger	102
MATHIEU Nadelhalter	25
Matrizen.....	107
Matrizen und Matrizenspanner.....	107
MAUNDER Mundkeil.....	32
MAYFIELD Hohlmeißelzangen.....	29
MAYO Sterilisierklammern.....	136
MAYO-HABERISSER	
Drahtwirbelzangen.....	126
MAYO-HEGAR Nadelhalter	25
McCALL Kürette	83
McCALL Scaler.....	77
McIVOR Mundsperrerr.....	39
MEAD Hämmer	27
Medizinlöffel.....	143
Mehrzweckschalen	142
Meißel.....	81-82
MERCITAN Scaler	79
MERCURY Modellierinstrument	116-119
MERCURY Parodontometer.....	88
MERIAM Zahnpinzetten	13
MERRIT A Parodontometer	88
MERSHON Bandtreiber.....	121
Meßbecher	142
METZENBAUM Präparierscheren.....	7
METZENBAUM-FINO	
Präparierscheren	7
MICHIGAN Parodontometer.....	88-89
MICHIGAN Zahnsonden.....	90
MILLER Artik. Papier-Pinzetten	120
MILLER Raspeln	26
MILLER-APEXO Wurzelheber.....	60
MILLER-COLBURN Küretten	71
MINI-LAMBOTTE Osteotome.....	27
MITCHELL Scaler.....	76
MIXTER-BABY Arterienklemmen	16
Modellierinstrument	116-120
MOLT Raspatorien	28
Mundsperrerr	37-39
Mundspiegelansatz.....	74
Mundspiegelgriff	74

N

NABERS Furkationssonde87
 NABERS Zahnsonden92
 Nadel-Sterilisierkästen.....138
 Nagelfeile.....40
 Nagelhautzangen40
 Nagelscheren40
 Nagelzangen40
 NEGUS Bruststütze.....39
 Nervkanal-Instrumente97
 NEVIUS Zahnzange56
 NORTHBENT Fadenscheren9
 NYSTROEM Modellierinstrument..... 117

O

OBWEGESER Raspatorien.....28
 OBWEGESER Wundhaken..... 21-22
 OCHSENBEIN Parodontalmeißel81
 ORBAN Gingivektomiemesser80
 ORBAN Parodontalfeile.....82
 Osteotome27

P

P.K. THOMAS Modellierinstrument ... 116
 PARMLY Zahnzange54
 Parodontalfeile.....82
 Parodontalmeißel81
 Parodontometer..... 88-90
 PARTSCH Osteotome27
 PEAN Arterienklemmen.....15
 PEET Splitterzangen13
 Pinzetten.....11-13
 Planstopfer 101-103
 Plugger97, 102
 Plugger, Nervkanal97
 Polierinstrumente.....100
 POTT Wurzelheber67
 Präparierscheren 7-8
 PRICHARD Chirurgische Kürette.....87
 Prüf- und Meßinstrumente.....1

R

RAMUS Wundhaken22
 Raspatorien28
 Raspeln26
 REDA Wundhaken.....19
 Reinigungsbürste.....137
 REYNOLDS Konturenzange131
 RHODES Parodontalmeißel.....81

ROCHESTER-PEAN

Arterienklemmen15
 ROSER-KOENIG Mundsperrer36
 ROUX-BABY Wundhaken19
 Rundzange127
 RUSKIN Hohlmeißelzangen.....30

S

SAUERBRUCH Abfallzange.....136
 Scaler 76-79
 SCHAEDEL Tuchklemmen.....16
 Schale, Kunststoff.....115
 Scheren 6-10
 Schieblehren.....1
 Schmelzmeißel96
 Schüsseln141
 Schwammzange17
 SCHWARZ Bügelbiegezangen.....129
 Sehnenscheren8
 SELDIN Wurzelheber60
 SENN-GREEN Hauthäkchen18
 Silikoneinlagen zu Mundsperrer37
 Silikon - Noppenmatte145
 Sinus-Lift Kürette135
 Skalpell-Griffe 3-4
 Skalpell-Klingen.....5
 Skalpellklingen-Entferner.....5
 Spatel 104-105
 SPENCER Fadenscheren9
 SPINA-NASALIS Wundhaken22
 Spirituslampen.....143
 Spreader, Nervkanal.....97
 Spritzen72
 Spannrahmen für Einschlagtücher ... 145
 Sputumbecher143
 Standgefäß.....142
 Sterilisierzangen136
 STERNBERG Wangen- und Lippenhalter.....34
 STEVENS Sehnenscheren.....8
 STIEGLITZ Splitterzangen13
 STOCKES Kofferdam-Klammerz108
 Stopfer 102-103

T

TANNER Plugger.....102
 TAYLOR Chirurgische Pinzetten11
 TAYLOR Scaler77
 Teleskopkronenzange.....123
 TOBOLD Wangen- und Lippenhalter.....34

TOENNIS-ADSON

Präparierscheren9
 TOFFLEMIRE Matrizen107
 TOLSDORF Knochenquetscher132
 TOMES Zahnzange55
 Tonsillenscheren.....9
 TOWNER Scaler77
 TOWNLEY Schieblehren.....1
 Trepanbohrer133
 TREYEMANN Kronenabnehmer122
 Tuchklemmen16
 Tuch.....145
 Tupfer- und Kornzangen.....17
 TWEED Drahtbiegezange128

U

UNIVERSAL Drahtschere.....9, 124
 Universal-Kramponzange130
 USA Kofferdam-Lochzange108

V

VIRTUS (RALK) Splitterzangen.....13
 VOLKMANN Scharfelöffel26

W

W.F. BARRY Wurzelheber65
 WAGNER feine Scheren10
 WALDSACHS Univ.-Kramponzange .130
 Wangen- und Lippenhalter34
 WARD Modellierinstrument117
 WARD Stopfer103
 WARD-KIRKLAND Scaler79
 WARWICK-JAMES
 Wurzelspitzenheber.....68
 Wasserspritze.....72
 Wattedosen143
 Watteträger.....23
 WEBSTER Nadelhalter24
 WEINGART Zahntechnikzange.....128
 WEISS-CASTROVIEJO
 Schieblehre.....2
 WEST Wurzelspitzenheber68
 WHITE Scaler.....79
 WHITE Zahnsonden.....91
 WHO Parodontometer88
 WIEDER Zungendrücker33
 WILLIAMS Parodontom/Sonde90
 WILLIAMS Parodontometer.....89
 WILLIAMS-GOLDMAN-FOX
 Parodontometer.....89
 WILLIGER Elevatorium28

WILLIGER Hämmer.....27
 WILLIGER Scharfelföfel26
 WINTER Wurzelheber66
 WITZEL Zahnzange58
 WIZARD Kofferdam-Halter109
 Wundhaken 19-22
 Wurzelheber 60-63, 65-67
 Wurzelspitzenheber 68-69

Y

YOUNG Schleifenformzange.....129
 YOUNG Zungenzangen34
 YOUNGER-GOOD Scaler76

Z

ZAHLE Modellierinstrument..... 119
 Zahnfleischscheren 10
 Zahnpinzetten.....13
 Zahnsonden..... 90-92
 Zahntechnikzange128
 Zahnzange, Amerikanische Form.. 53-59
 Zahnzangen zu Eckzähne
 und Prämolaren.....47
 Zahnzangen zu
 Molaren..... 43, 46, 48, 50-52, 56, 59
 Zahnzangen zu Molaren
 und Prämolaren.....54
 Zahnzangen zu Molaren
 und Weisheitszähne53
 Zahnzangen zu
 Prämolaren 42, 44-45, 50,52
 Zahnzangen zu Prämolaren,
 Schneidezähne und Wurzeln..... 56-57
 Zahnzangen zu Schneide
 und Eckzähne..... 42, 50, 52-53
 Zahnzangen zu Schneidezähne 52-53
 Zahnzangen zu Schneidezähne
 und Prämolaren tiefgreifend44
 Zahnzangen zu Schneidezähne
 und Wurzeln46, 50, 55
 Zahnzangen zu Seitliche
 Schneidezähne und Prämolaren42
 Zahnzangen für
 Zähne und Wurzeln55, 57, 59
 Zahnzangen zu
 Weisheitszähne 46-47, 57
 Zahnzangen zu
 Wurzeln44-45, 47-49, 51-52
 Zahnzangen zu Wurzeln
 und Schneidezähne.....43
 Zahnzangen zu

Wurzelreste 48-49, 55, 57
 Zahnzangen Englische Form 42-51
 ZAUFAL-JANSEN
 Hohlmeißelzangen.....30
 Zementspatel.....106
 Zungendrücker33
 Zungenzangen.....34
 Zwickzangen.....125

A

ABELL Contouring pliers 131
 ADAMS Technical pliers 129
 ADERER Band removing pliers 128
 ADERER pliers 129
 ADSON Dressing forceps 12
 ADSON Haemostatic forceps 16
 AINSWORTH Punch forceps 108
 ALLIS Intestinal and tissue grasping forceps 17
 ALLIS-BABY Intestinal and tissue grasping forceps 17
 Amalgam carrier 98
 Amalgam finger bowl 98
 ANGLE Wire bending pliers 128
 APICAL Luxator 64
 APICAL Root elevator 61
 ASH Gum knife 4

B

BABCOCK Intestinal and tissue grasping forceps 17
 BACKHAUS Towel clamp 16
 BALL AND SOCKET Towel clamps 16
 Ball type condenser 100
 Ball type condenser/Spatula 105
 Band removing pliers 128
 Bar bending pliers 129
 BARRY Root elevator 65
 BAUMGARTNER Needle holders 24
 BEALE Carver 119
 BEEBEE Wire cutting scissors 124
 BEIN Luxator 64
 BEIN Root elevator 63
 BEYER Bone rongeurs 29
 BLACK Enamel chisel 96
 BÖHLER Bone cutting forceps 30
 BÖHLER Bone rongeurs 30
 BOLEY Caliper 1
 Bone crusher 132
 Bone curettes 70-71
 Bone Files 82
 Bone mill 132
 Bone rongeurs 29-30
 Bone scraper 134
 Bowl 115
 Bowls 141
 BOWMAN Probe 23
 Box 142
 BREWER Clamp forceps 108

BRIAULT Explorer 90
 Bridge removing pliers 130
 BRUENINGS Tongue depressors 33
 Brush Dispenser 41
 BUNT Safety pins 136

C

Caliper 1
 Cannula Luer Lock 72
 Cartridge Syringe 72
 Carving instruments 116-120
 CASTROVIEJO Caliper 2
 CASTROVIEJO Needle holders 25
 CASTROVIEJO-EPKER Caliper 2
 CAWOOD-MINNESOTA Tongue depressors 33
 Cement Mixing Spatula 106
 CHEATTLE Sterilization Forceps 136
 Cheek and lip retractor 34
 Chisels 81-82
 Containers 145
 CHOMPRET Root fragment elevator 68
 Clamps 109
 Clasps Bending pliers 129
 Cleaning Brushes 137
 Cleoid-Discoïd carver 118
 CLEVELAND Bone rongeurs 29
 NEGUS Chest support 39
 COLEMAN Root elevator 61
 COLLIN Tongue holding forceps 34
 COLUMBIA Curette 83
 Composite instrument 98-99
 Condenser 102-103
 Contouring pliers 127, 131
 Cotton applicators 23
 Cotton wool containers 143
 COUPLAND Root elevator 61
 COUPLAND Suction tube 31
 CRANE-KAPLAN Scaler 79
 CRILE-MURRAY Needle holders 24
 CRILE-WOOD Needle holders 24
 CROSS Explorer 90
 Crown Setter 121
 Crown Spreader 121
 CROWN-BUTLER Crown Remover 122
 CRYER Extracting forceps 56-57
 CRYER Root elevator 60-61
 CUMINE Scaler 76
 Curettes 83-87

Cuticle Nippers 40
 Cups 143

D

DAVIS-BOYLE Mouth gag 37
 DE BAKEY Needle holders 25
 DEAN Tonsil scissors 9
 Delicate Scissors 10
 DENHART Mouth gag 36
 Dental Forceps 13
 DERF Needle holders 24
 DESMARRES Saddle hooks 18
 DIAMANT Telescopic crown pliers 123
 Diamond Inserts for telescopic Crown pliers 123
 DINGMANN Mouth gag 38
 Dissecting Scissors 7-8
 Distal Cutter 125
 DOYEN-JANSEN (MOLT) Mouth gag 36
 Drape 145
 Dressing and tissue forceps 11-12
 Dressing Forceps 17
 DUMONT Flat nose pliers 127

E

Elephant Foot condenser 100
 Enamel chisels 96
 End and side nippers 125
 Examination and measuring instruments 1
 Excavator 93-95
 Explorer 90-92
 Extracting Forceps for American Form 53-59
 Extracting Forceps for bicuspid 42, 44-45, 50, 52
 Extracting Forceps for bicuspid, incisors and roots 56-57
 Extracting Forceps for cuspids and bicuspid 47
 Extracting Forceps for English Form 42-51
 Extracting Forceps for incisors 52-53
 Extracting Forceps for incisors and bicuspid deep-gripping 44
 Extracting Forceps for incisors and bicuspid 42
 Extracting Forceps for incisors and cuspids 42, 50, 52-53
 Extracting Forceps for incisors

and roots.....46, 50, 55
 Extracting Forceps for
 molars..... 43, 46, 48, 50-52, 56, 59
 Extracting Forceps for molars
 and bicuspid.....54
 Extracting Forceps for molars
 and third molars.....53
 Extracting Forceps for
 root fragments 48-49, 55, 57
 Extracting Forceps for
 roots.....44-45, 47-49, 51-52
 Extracting Forceps for roots
 and incisors43
 Extracting Forceps for teeth
 and roots.....55, 57, 59
 Extracting Forceps for
 third molars..... 46-47, 57

F

FAHNENSTOCK Plaster knife 120
 FARABEUF Retractors19
 FARRELL Cotton applicators.....23
 FEDI Periodontal chisel81
 FELT Composite instrument99
 Filling instruments.....100
 Flat nose pliers 126-127
 FLOHR Root Elevator..... 60-61
 FOERSTER Sponge forceps.....17
 Forceps..... 11-13
 FRAHM Modelling carver 117
 FRAZIER Nerve and wound hook 18
 FRAZIER/FERGUSSON
 Suction tube.....31
 FRIEDMAN Bone rongeurs29
 FRIEDMAN Mini Bone rongeurs.....29
 FRIEDMAN Root elevator62
 Furcation Curettes87
 FURRER Bridge removing pliers.....130

G

GILLIES Nerve and wound hook 18
 GILLIES Tissue Forceps..... 11
 Gingival Cord packer 115
 Gingivectomy knives.....80
 GISY-WILD Wax knife 120
 GOLDMAN-FOX
 Gingivectomy knife80
 GOLDMAN-FOX Gum scissors..... 10
 GOLDMAN-FOX
 Periodontal probe 88-90
 GOLDMAN-FOX Scaler79

GOLDSTEIN Composite instrument ...99
 GOSLEE Contouring pliers127
 GRACEY (MINI) Curettes.....85
 GRACEY (RIGID) Curettes86
 GRACEY Curettes.....84
 Graduated Measures.....142
 GRAEFE Nerve and wound hook.....18
 GREEN Retractors20
 GRITMANN Plaster knife.....120
 GROSS-MAIER Dressing forceps.....17
 Gum Scissors10
 GUTHRIE Nerve and wound hook18

H

HALSEY Needle holders24
 HALSTED-MOSQUITO
 Hemostatic forceps.....14
 HARRIS Extracting forceps54
 HARTMANN Hemostatic forceps14
 HARTMANN Tongue depressors.....33
 HEIDBRINK Root tip pick69
 HEISTER Mouth gag.....36
 HEMINGWAY Bone curettes70
 Hemostatic Forceps..... 14-16
 HENAHAN Extracting forceps53
 Hex key for telescopic crown pliers ... 123
 HIRSCHFELD Bone file.....82
 HOLLENBACK Modelling carver 117
 HOLLENBACK Plugger102
 HOW Utility & crown pliers131
 HYGIENIST Scaler77
 HYLIN Carver 119
 HYLIN Root Elevator62

I

Impression trays 110-114
 Impression tray for edentulous ... 111-113
 Impression tray for functional
 impressions 112-113
 Impression tray for
 partially toothed 110, 112
 Impression trays for
 partial impressions..... 114
 Injection Needle.....73
 Inserts for Crown-Butler.....122
 Instrument Boxes.....139
 Instruments for crown work 122-123
 Intestinal and Tissue
 grasping forceps17
 IRIS scissors.....8
 IVORY Clamp forceps108

IVORY Matrix retainers.....107
 IVORY Rubber dam clamps109
 IWANSON Caliper2

J

JAQUETTE Scaler.....76, 78
 Jars.....142
 JENNINGS Mouth gag36
 JOHNSON Contouring pliers.....131
 JONES Towel forceps.....16
 JOSEPH Dissecting scissors.....8
 JOSEPH Nerve and wound hook18

K

KELLY Dissecting scissors8
 KERRISON Antrum punch forceps.....30
 KILNER Skin hook.....18
 KIRKLAND Gingivectomy knife80
 KLEIN Extracting forceps52
 KOCHER-LANGENBECK Retractor...20
 KRALLENHEBER Root elevator67
 KRAMERS Sinus-lift curette135

L

LA GRANGE Gum scissors10
 LADMORE Condenser103
 LANGENBECK Finger protectors.....32
 LANGENBECK Retractors20
 LANGER Curettes83
 Laryngeal Mirrors.....75
 LAWRENCE-READ
 Extracting forceps.....47, 51
 Le CRON carver 119
 LECLUSE Root elevator.....66
 LERICHE Haemostatic forceps15
 LEXER Dissecting scissors8
 LICHTENBERG Needle holders.....25
 LICHTENSTEIN Spatula 115
 LINDO-LEVIAN Root elevator61
 Lip and cheek retractor.....35
 LITTAUER Stitch scissors9
 LOCKLIN Gum scissors10
 LONDON-COLLEGE
 Dental forceps13
 LUCAS Bone curettes71
 LUER Bone rongeurs29
 LUNIATSCHEK Gauze packers23
 Luxators.....64
 Mallets27

M

MARKLEY Plugger102
 MATHIEU Needle holders25
 Matrix band.....107
 Matrix bands and retainers107
 MAUNDER Oral wedges32
 MAYFIELD Bone rongeurs29
 MAYO Safety pins136
 MAYO-HABERISSER
 Wire twisting forceps126
 MAYO-HEGAR Needle holders25
 McCALL Currettes83
 McCALL Scaler.....77
 McIVOR Mouth gag39
 MEAD Mallets27
 Medicine Spoon.....143
 MERCITAN Scaler.....79
 MERCURY Modelling carver 116-119
 MERCURY Periodontal probe88
 MERIAM Dental forceps13
 MERRIT A Periodontal probe88
 MERSHON Band pusher.....121
 METZENBAUM
 Dissecting scissors.....7
 METZENBAUM-FINO
 Dissecting scissors.....7
 MICHIGAN Periodontal probe 88-89
 MICHIGAN Explorer90
 MILLER Paper forceps120
 MILLER Rasps26
 MILLER-APEXO Root elevator.....60
 MILLER-COLBURN Bone currettes.....71
 MINI-LAMBOTTE Osteotome27
 MITCHELL Scalars.....76
 MIXTER-BABY
 Haemostatic forceps.....16
 Modelling Carver 116-120
 MOLT Raspatories.....28
 Mouth Gags 37-39
 Mouth Mirrors74
 Mouth Mirror Handles74

N

NABERS Explorer92
 NABERS Furcation probe.....87
 Nail brushes.....41
 Nail files40
 Nail nippers.....40
 Nail scissors40
 Needle Sterilizing cases138
 NEVIUS Extracting forceps56

NORTHBENT Stitch scissors9
 Nose pliers..... 126-127
 NYSTROEM Modelling carver 117

O

OBWEGESER Raspatories.....28
 OBWEGESER Retractors 21-22
 OCHSENBEIN Periodontal chisel81
 Operating Scissors6, 8
 ORBAN Gingivectomy knife80
 ORBAN Periodontal file82
 Osteotome27

P

P.K. THOMAS Modelling carver 116
 PARMLY Extracting forceps.....54
 PARTSCH Osteotome27
 PEAN Hemostatic forceps15
 PEET Splinter forceps13
 Periodontal chisels81
 Periodontal file.....82
 Periodontal probes 88-90
 Periosteal elevators28
 Plane condenser 101-103
 Plastic tip for amalgam carrier98
 Pliers for dental.....128
 Pluggers97, 102
 Pluggers Root canal97
 Polisher.....100
 POTT Root elevator.....67
 PRICHARD Bone currettes.....87
 Probes23

R

RAMUS Retractors22
 Rasps26
 REDA Retractors19
 Retractors 19-22
 REYNOLDS Contouring pliers.....131
 RHODES Periodontal chisel.....81
 ROCHESTER-PEAN
 Hemostatic forceps.....15
 Root canal instruments.....97
 Root Elevator..... 60-63, 65-67
 Root Fragment elevators 68-69
 ROSER-KOENIG Mouth gag.....36
 ROUX-BABY Retractor.....19
 Rubber Dam instruments..... 108-109
 RUSKIN Bone rongeurs30

S

SAUERBRUCH Waste forceps136
 Scalars..... 76-79
 Scalpel Blade remover5
 Scalpel Blades.....5
 Scalpel Handles..... 3-4
 SCHAEDEL Towel forceps16
 SCHWARZ Pliers129
 Scissors 6-10
 SELDIN Root elevator60
 Silicone pads for Mouth gag37
 Silicon mat145
 Sinus-lift curette.....135
 Spare blade for Bone scraper.....134
 Spatulas..... 104-105
 SPENCER Stitch scissors9
 SPINA-NASALIS Retractors.....22
 Spirit Lamps.....143
 Sponge Forceps17
 Spreader, Root canal.....97
 Sputum Cup.....143
 Sterilization instruments136
 Sterilizing forceps138
 STERNBERG Cheek
 and lip retractor.....34
 STEVENS Tendon scissors8
 STIEGLITZ Splinter forceps13
 Stitch Scissors9
 Storage Tray144
 STOCKES Clamp forceps108
 Storage cases.....140
 Syringes.....72

T

TANNER Plugger.....102
 TAYLOR Scaler77
 TAYLOR Tissue forceps11
 Telescopic Crown pliers.....123
 Tension clips for towels.....145
 Tendon scissors.....8
 Tissue forceps11-12
 Tissue grasping forceps17
 TOBOLD Cheek and lip retractor34
 TOENNIS-ADSON
 Dissecting scissors9
 TOFFLEMIRE Matrices107
 TOLSDORF Bone crusher.....132
 TOMES Extracting forceps55
 Tongue Depressors33
 Tongue Holding forceps.....34
 Tonsil scissors9

Towel forceps.....16
 TOWNER Scaler77
 TOWNLEY Caliper1
 Trepine Burs133
 TREYEMANN Crown remover122
 TWEED Wire bending pliers.....128

U

Universal pliers.....130
 Universal trays.....142
 UNIVERSAL Wire cutting
 scissors.....9, 124
 USA Punch forceps108

V

VIRTUS (RALK) Splinter forceps.....13
 VOLKMANN Bone curettes26

W

W.F. BARRY Root elevator65
 WAGNER Delicate scissors10
 WALDSACHS Universal pliers130
 WARD Condenser103
 WARD Modelling carver117
 WARD-KIRKLAND scaler79
 WARWICK-JAMES
 Root fragment elevator68
 Water Syringe.....72
 WEBSTER Needle holders.....24
 WEINGART Pliers for
 dental labs128
 WEISS-CASTROVIEJO Caliper2
 WEST Root fragment elevator.....68
 WHITE Explorer.....91
 WHITE Scaler.....79
 WHO Periodontal probe88
 WIEDER Tongue depressor33
 WILLIAMS Periodontal probes89
 WILLIAMS Probe explorer.....90
 WILLIAMS-GOLDMAN-FOX
 Periodontal probe89
 WILLIGER Bone curettes26
 WILLIGER Elevator28
 WILLIGER Mallets27
 WINTER Root elevator66
 Wire Bending pliers128
 Wire Cutter125
 Wire Cutting pliers124
 Wire Seizing forceps.....126
 WITZEL Extracting forceps.....58
 WIZARD Rubber Dam holder.....109

Y

YOUNG Loop forming pliers.....129
 YOUNG Tongue holding forceps34
 YOUNGER-GOOD Scalers76

Z

ZAHLE Carver119
 ZAUFAL-JANSEN Bone rongeurs.....30

A

ABELL Alicate para contornear 131
 Abre-Bocas..... 37-39
 ADAMS Alicate para técnica..... 129
 ADERER Alicate para contornear..... 129
 ADERER Alicate para sacar bandas 128
 ADSON Pinza de disección..... 12
 ADSON Pinzas hemostáticas 16
 Agujas hipodérmicas 72
 AINSWORTH Perforadores..... 108
 Alicates de pico plano 126-127
 Alicate para barras 129
 Alicate para cortar alambres..... 125
 Alicate para doblar alambres..... 128
 Alicate para sacar bandas 128
 Alicates cortantes 125
 Alicates corta-uñas 40
 Alicates extendedores de coronas 121
 Alicates para contornear..... 127, 131
 Alicates para coronas 131
 Alicates para puentes 130
 Alicates telescópicos para coronas..... 123
 Alicates universales..... 130
 ALLIS Pinzas para intestinos y tejidos 17
 ALLIS-BABY Pinzas para intestinos y tejidos 17
 ANGLE Alicate doblar alambres..... 128
 APICAL Elevador para raíces..... 61
 APICAL Luxador 64
 Aplastador óseo..... 132
 ASH Bisturías para encías 4

B

BABCOCK Pinzas para intestinos y tejidos 17
 BACKHAUS Pinzas de campo 16
 Baja-lenguas..... 33
 BALL AND SOCKET Pinzas de campos 16
 Bandejas para instrumentos..... 142
 BARRY Elevador para raíces 65
 BAUMGARTNER Porta-agujas 24
 BEALE Tallador y espátula 119
 BEEBEE Tijeras para alambre 124
 BEIN Elevador para raíces 63
 BEIN Luxador 64
 BEYER Pinzas-gubias..... 29
 Bisturías para la gingivectomía 80

BLACK Cíncel para esmalte 96
 BÖHLER Pinzas cortantes para hueso..... 30
 BÖHLER Pinzas-gubias 30
 BOLEY Calibre 1
 BOWMAN Sonda..... 23
 BREWER Porta-clamps..... 108
 BRIAULT Sondas 90
 BRUENINGS Baja-lenguas 33
 BUNT Cadres de esterilización 136

C

Cajas para almacenaje..... 140
 Cajas para instrumentos..... 139
 Calibre 1
 Cánula Luer Lock 72
 CASTROVIEJO Calibre..... 2
 CASTROVIEJO Micro-porta-agujas 25
 CASTROVIEJO-EPKER Calibre 2
 CAWOOD-MINNESOTA Baja-lenguas..... 33
 Cepillo para uñas..... 41
 Cepillos de limpieza..... 137
 CHEATTLE Pinzas para esterilización..... 136
 CHOMPRET Elevador 68
 Cinceles..... 81-82
 Cinceles de periodoncia 81
 Cinceles para esmalte 96
 Clamps 109
 Cleoid-Discoïd Tallador..... 118
 CLEVELAND Pinzas-gubias..... 29
 Contenedores..... 145
 Colchón de silicona 145
 COLEMAN Elevador para raíces..... 61
 COLLIN Pinza tira-lenguas..... 34
 COLUMBIA Cureta 83
 Combinación condensador..... 100
 Combinación tapa-pinza..... 138
 Condensador 102-103
 Condensador pie de elefante 100
 Condensador plano 101-103
 Condensador tipo bola y espátula 105
 Copas graduadas 142
 COUPLAND Elevador para raíces 61
 COUPLAND tubos de aspiración 31
 CRANE-KAPLAN Limpiadores de sarro..... 79
 CRILE-MURRAY Porta-agujas 24
 CRILE-WOOD Porta-agujas..... 24
 CROSS Sondas..... 90

CROWN-BUTLER Extractor de coronas..... 122
 CRYER Elevador para raíces..... 60-61
 CRYER Fórceps dentales 56-57
 Cubetas 141
 Cubeta para impresión mandíbulas 110, 112
 Cubeta para impresión mandíbulas parcialmente..... 110, 112
 Cubeta para impresiones 110-114
 Cubeta para impresiones funcionales 112-113
 Cubetas para impresiones parciales..... 114
 Cuchara medicinal..... 143
 Cucharillas cortantes 70-71
 Cuchilla de repuesto para Raspador de hueso 134
 CUMINE Limpiadores de sarro..... 76
 Cureta de furcación 87
 Curetas para Sinus Lift 135
 Curettas 83-87

D

DAVIS-BOYLE Abre-Bocas 37
 DE BAKEY Porta-agujas 25
 DEAN Tijeras para amígdalas 9
 DENHART Abre-Bocas..... 36
 DERF Porta-agujas 24
 DESMARRES Ganchos en forma de silla 18
 DIAMANT Alicates telescópicos para coronas..... 123
 DINGMANN Abre-Bocas 38
 Dique de goma 108-109
 Distribuidor de cepillos 41
 Distribuidores de algodón..... 143
 DOYEN-JANSEN (MOLT) Abre-Bocas..... 36
 DUMONT Alicate, pico plano 127

E

Elevador para raíces 60-63, 65-67
 Elevadores para fragmentos de raíces..... 68-69
 Escofinas 26
 Escupidera..... 143
 Espátula 104-105
 Espátula para cemento..... 106
 Espejo de boca..... 74
 Espejos laringeos 75

Estuches para esterilizar agujas.....138
 Excavador..... 93-95
 Extendedor para canales.....97

F

FAHNENSTOCK
 Cuchillo para yeso.....120
FARABEUF Separadores.....19
FARRELL porta algodones.....23
FEDI Cíncel de periodoncia.....81
FELT Instrumento compuesto99
 Fijador de coronas.....121
FLOHR Elevador para raíces 60-61
FOERSTER Pinzas porta-esponjas17
 Fórceps de extracción para caninos y premolares.....47
 Fórceps de extracción para dientes y raíces55, 57, 59
 Fórceps de extracción para fragmentos de raíces..... 48-49, 55, 57
 Fórceps de extracción para Incisivos y premolares a gran calado.....44
 Fórceps de extracción para Incisivos y caninos 42, 50, 52-53
 Fórceps de extracción para incisivos y raíces46, 50, 55
 Fórceps de extracción para molares..... 43, 46, 48, 50-52, 56, 59
 Fórceps dentales forma americana 53-59
 Fórceps de extracción para molares y premolares54
 Fórceps de extracción para molares y terceros molares53
 Fórceps de extracción para ncisivos..... 52-53
 Fórceps de extracción para nIncisivos y premolares42
 Fórceps de extracción para premolares..... 42, 44-45, 50, 52
 Fórceps de extracción para premolares, incisivos y raíces 56-57
 Fórceps de extracción para raíces..... 44-45, 47-49, 51-52
 Fórceps de extracción para raíces y incisivos43
 Fórceps de extracción para terceros molares..... 46-47, 57
 Fórceps dentales para niños59
 Fórceps dentales, forma inglesa .. 42-51
FRAHM Tallador para modelar 117

FRAZIER Ganchos y ganchitos para nervios.....18
FRAZIER/FERGUSSON tubos de aspiración31
FRIEDMAN Elevador para raíces.....62
FRIEDMAN Mini Pinzas-gubias.....29
FRIEDMAN Pinzas-gubias29
FURRER Alicates para puentes 130

G

GILLIES Ganchos y ganchitos para nervios.....18
GILLIES Pinzas de disección con diente11
GISY-WILD Cuchillo para cera120
GOLDMAN-FOX Bisturí.....80
GOLDMAN-FOX Limpiadores de sarro.....79
GOLDMAN-FOX Sonda parodontales..... 88-90
GOLDMAN-FOX Tijeras para encías10
GOLDSTEIN Instrumento Compuest99
GOSLEE Alicata127
GRACEY (MINI) Curetta.....85
GRACEY (RIGID) Curetta86
GRACEY Curetta.....84
GRAEFE Ganchos y ganchitos para nervios18
GREEN Separadores20
GRITMANN Cuchillo para yeso.....120
GROSS-MAIER Pinzas para tampones y curaciones.....17
 Gubias 29-30
GUTHRIE Ganchos y ganchitos para nervios.....18

H

HALSEY Porta-agujas24
HALSTED-MOSQUITO Pinzas hemostáticas.....14
HARRIS Fórceps dentales54
HARTMANN Baja-lenguas33
HARTMANN Pinzas Hemostáticas.....14
HEIDBRINK Elevador69
HEISTER Abre-Bocas36
HEMINGWAY Cucharillas.....70
HENAHAN Fórceps dentales53
HIRSCHFELD Lima de hueso Lima parodontal.....82

Hojas de bisturí..... 4-5
HOLLENBACK Obturador102
HOLLENBACK Tallador per modelar..... 117
HOW Alicates para coronas131
HYGIENIST Limpiadores de sarro77
HYLIN Elevador para raíces.....62
HYLIN Tallador y espátula 119

I

Inserto de silicona para Abre-Bocas...37
 Instrumento compuesto..... 98-99
 Instrumentos para coronas..... 122-123
 Instrumentos para exámenes y medidas.....1
 Instrumentos para hilo retractor 115
 Instrumentos para la esterilización136
 Instrumentos para modelar..... 116-120
 Instrumentos para obturaciones 100
 Instrumentos para canales97
IRIS Tijeras para cirugía8
 Instrumentos para pulir.....100
IVORY Clamp109
IVORY Portaclamps108
IVORY Portamatrice107
IWANSON Calibre2

J

JAQUETTE Limpiadores de sarro76, 78
JENNINGS Abre-Bocas.....36
 Jeringa para agua.....72
 Jeringa para cartucho ampollas72
 Jeringas de inyección.....73
JOHNSON Alicates para coronas.....131
JONES Pinzas de campos 16
JOSEPH Ganchos y ganchitos para nervios.....18
JOSEPH Tijeras de disección.....8

K

KELLY Tijeras de disección8
KERRISON Pinzas cortantes para maxilares30
KILNER Ganchos cutáneos.....18
KIRKLAND Bisturí para la gingivectomía.....80
KLEIN Fórceps dentales.....52
KOCHER-LANGENBECK Separadores.....20
KRALLENHEBER Elevadores

para raíces.....67
 KRAMERS Curetas para Sinus Lift ..135

L

LA GRANGE Tijeras para encías.....10
 LADMORE Condensador103
 Lámparas de alcohol143
 LANGENBECK Dedales.....32
 LANGENBECK Separadores20
 LANGER Curetta83
 LAWRENCE-READ Fórceps dentales47, 51
 Le CRON Tallador y espátula119
 LECLUSE Elevador para raíces66
 LERICHE Pinzas hemostáticas15
 LEXER Tijeras de disección8
 LICHTENBERG Porta-agujas.....25
 LICHTENSTEIN Espátula.....115
 Limas de hueso82
 Lima Parodontal82
 Limas para uñas40
 Limpiadores de sarro76-79
 LINDO-LEVIAN Elevador para raíces.....61
 LITTAUER Tijeras para hilos9
 Llave hexagonal123
 LOCKLIN Tijeras para encías10
 LONDON-COLLEGE Pinzas dentales13
 LUCAS Cucharillas cortantes71
 LUER Pinzas-gubias29
 LUNIATSCHEK Taponeadores.....23
 Luxadores.....64

M

Mango para espejos de boca74
 Mangos de bisturíes3-4
 Marcos tensores para paños145
 MARKLEY Obturador102
 Martillos27
 MATHIEU Porta-agujas25
 Matrice.....107
 MAUNDER Abreboca32
 MAYFIELD Pinzas-gubias29
 MAYO Cadres de esterilización.....136
 MAYO-HABERISSER Pinzas para torcer alambre126
 MAYO-HEGAR Porta-agujas.....25
 McCALL Curetta83
 McCALL Limpiadores de sarro77
 McIVOR Abre-Bocas39

MEAD Martillos27
 MERCITAN Limpiadores de sarro79
 MERCURY Sonda parodontales88
 MERCURY Tallador para modelar116-119
 MERIAM Pinzas dentales13
 MERRIT A Sonda parodontales.....88
 MERSHON Ajustador de bandas121
 METZENBAUM Tijeras de disección.....7
 METZENBAUM-FINO Tijeras de disección.....7
 MICHIGAN Sonda parodontales ... 88-89
 MICHIGAN Sonda90
 MILLER Escofinas26
 MILLER Pinzas para papel.....120
 MILLER-APEXO Elevadores para raíces.....60
 MILLER-COLBURN Cucharillas71
 MINI-LAMBOTTE Osteótomo.....27
 MITCHELL Limpiadores de sarro76
 MIXTER-BABY Pinzas hemostáticas ..16
 Molino de huesos132
 MOLT Periostótomos.....28

N

NABERS Sonda de furcación.....87
 NABERS Sondas.....92
 NEGUS Soporte de pecho39
 NEVIUS Fórceps dentales.....56
 NORTHBENT Tijeras para hilos9
 NYSTROEM Tallador para modelar ..117

O

Obturador97, 102
 Obturador para canales.....97
 Condensador tipo bola100
 OBWEGESER Periostótomos28
 OBWEGESER Separadores21-22
 OCHSENBEIN Cíncel de Periodoncia.....81
 ORBAN Bisturí.....80
 ORBAN Lima parodontal cíncel.....82
 Osteótomo27

P

P.K. THOMAS Tallador para modelar116
 Paño145
 PARMLY Fórceps dentales.....54
 PARTSCH Osteótomo27

PEAN Pinzas hemostáticas.....15
 PEET Pinzas para espinas.....13
 Periostótomos, legbras.....28
 Pieza de inserción122
 Piezas de inserción de diamante para alicates telescópicos para coronas...123
 Pinza de técnica128
 Pinza tira-lenguas.....34
 Pinzas.....29-30
 Pinzas de campos16
 Pinzas de disección.....11-12
 Pinzas dentales13
 Pinzas hemostáticas.....14-16
 Pinzas para coger alambres.....126
 Pinzas para intestinos y tejidos17
 Pinzas para tampones y curaciones...17
 Pinzas para tejidos17
 Pinzas porta-esponjas17
 Pinzas y Tjeras cuticulares40
 Porta algodones23
 Porta amalgamas98
 Porta matrices y matrices107
 POTT Elevador para raíces67
 PRICHARD Cureta para hueso.....87

Q

Quita hojas5

R

RAMUS Separadores22
 Raspador de hueso134
 Recipientes.....142
 REDA Separadores19
 REYNOLDS Alicates para coronas ...131
 RHODES Cíncel de periodoncia.....81
 ROCHESTER-PEAN Pinzas Hemostáticas.....15
 ROSER-KOENIG Abre-Bocas36
 ROUX-BABY Separadores.....19
 RUSKIN Pinzas-gubias30

S

SAUERBRUCH Pinza para desechos136
 SCHAEDEL Pinzas de campos.....16
 SCHWARZ Alicate129
 SELDIN Elevadores para raíces.....60
 Separadores19-22
 Separadores para labios y mejillas.....34
 Sólo aditamento de plástico para Porta amalgamas98

Sondas	23, 90-92
Sondas parodontales.....	88-90
Sparadores universal.....	35
SPENCER Tijeras para hilos.....	9
SPINA-NASALIS Separadores.....	22
STERNBERG Separadores para labios y mejillas	34
STEVENS Tijeras para tendones	8
STIEGLITZ Pinzas para espinas	13
STOCKES Portaoclamps	108

T

Tallador para modelar.....	116-118
TANNER Obturador.....	102
Tarros.....	142-143
TAYLOR Limpiadores de sarro.....	77
TAYLOR Pinzas de disección	11
Tijeras.....	6-10
Tijeras de disección.....	7-8
Tijeras finas	10
Tijeras para amígdalas	9
Tijeras para cirugía.....	6, 8
Tijeras para encías	10
Tijeras para hilos	9
Tijeras para tendones.....	8
Tijeras para uñas.....	40
TOBOLD Separadores para labios y mejillas	34
TOENNIS-ADSON Tijeras de disección.....	9
TOFFLEMIRE Matrice.....	107
TOLSDORF Aplastador óseo	132
TOMES Fórceps dentales	55
TOWNER Limpiadores de sarro.....	77
TOWNLEY Calibre	1
Tray para depositar	144
Trephine	133
TREYEMANN Extractor de coronas..	122
TWEED Alicata doblar alambre.....	128

U

UNIVERSAL Tijeras para alambre	9, 124
USA Perforadores.....	108

V

Vasos graduados.....	143
VIRTUS (RALK) Pinzas para espinas.....	13
VOLKMANN Cucharillas cortantes.....	26

W

W.F. BARRY Elevador para raíces	65
WAGNER Tijeras finas	10
WALDSACHS Alicates universale	130
WARD Condensador	103
WARD Tallador para modelar	117
WARD-KIRKLAND Limpiadores de sarro.....	79
WARWICK-JAMES Elevador	68
WEBSTER Porta-agujas	24
WEINGART Pinza de técnica.....	128
WEISS-CASTROVIEJO Calibre	2
WEST Elevador	68
WHITE Limpiadores de sarro	79
WHITE Sondas.....	91
WHO Sondas parodontales.....	88
WIEDER Baja-lenguas	33
WILLIAMS Sondas Parodontales	89-90
WILLIAMS-GOLDMAN-FOX Sondas parodontales.....	89
WILLIGER Cucharillas cortantes.....	26
WILLIGER Elevador	28
WILLIGER Martillos	27
WINTER Elevador para raíces	66
WITZEL Fórceps dentales.....	58
WIZARD Sostenedor.....	109

Y

YOUNG Alicates.....	129
YOUNG Pinza tira-leng	34
YOUNGER-GOOD Limpiadores de sarro.....	76

Z

ZAHLE Tallador y espátula.....	119
ZAUFAL-JANSEN Pinzas-gubias.....	30

A

Abassalingua	33
ABELL Tenaglie per profili	131
Ablatore di tartaro	76-79
Accessorio in plastica per Cucchiaino portamalgama	98
ADAMS Tenaglie per tecnica	129
ADERER Pinza per levare bande.....	128
ADERER Tenaglie per profili	129
ADSON Pinze emostatiche	16
ADSON Pinze per dissezione.....	12
AINSWORTH Pinze foradiga	108
ANGLE Pinza tecnica per filo	128
APICAL Leve per radici	61
APICAL Luxatori	64
Apribocca.....	37-39
ASH Coltelli per gengive.....	4

B

BABCOCK Atrauma pinze per afferrare intestino e tessuti	17
Bacinelle per strumenti	142
BACKHAUS Pinze fissateli.....	16
BALL AND SOCKET Pinze fissateli.....	16
BARRY Leve per radici.....	65
BAUMGARTNER Port'aghi	24
Bacinelle per il deposito.....	144
BEALE Strumento per modellare	119
BEEBEE Forbici per filo metallico	124
BEIN Leve per radici.....	63
BEIN Luxatori	64
BEYER Pinze sgorbie.....	29
Bicchieri graduati	142
Bicchieri per medicinali.....	143
Bisturie per gengivectomia	80
BLACK Tagliasmalto	96
BÖHLER Pince coupantes à os.....	30
BÖHLER Pinzas-gubias	30
BOLEY Calibro	1
BOWMAN Sonda.....	23
BREWER Pinze per uncini	108
BRIAULT Sonda	90
BRUENINGS Abassalingua.....	33
BUNT Spilloni per sterilizzazione	136

C

Calibri	1
Cannula Luer Lock	72
CASTROVIEJO Calibro.....	2
CASTROVIEJO Micro portaghi	25
CASTROVIEJO-EPKER Calibro	2

CAWOOD-MINNESOTA

Abassalingua	33
CHEATTLE Pinze per strumenti sterilizzati.....	136
CHOMPRET Leve per frammenti	68
Cleoid-Discoid strumento	118
CLEVELAND Pinze sgorbie	29
CNEGUS Supporto per petto	39
COLEMAN Leve per radici	61
COLLIN Pinza tiralingua.....	34
COLUMBIA Curetta	83
Container	145
Combinazione spatola.....	100
COUPLAND Leve per radici	61
COUPLAND tubi d aspirazione	31
Combinazione sfera/spatola	105
CRANE-KAPLAN Ablatore di tartaro	79
CRILE-MURRAY Port'aghi	24
CRILE-WOOD Port'aghi.....	24
CROSS Sonda	90
CROWN-BUTLER Estrattore per corona	122
CRYER Leve per radici	60-61
CRYER Pinze per estrazione	56-57
Cucchiaino portamalgama.....	98
Cucchiaino per medicinali.....	143
CUMINE Ablatore di tartaro.....	76
Curetta di forcazione	87
Curette.....	83-87
Curette Sinus-Lift.....	135
Curette taglienti	70-71

D

DAVIS-BOYLE Apribocca	37
DE BAKEY Port'aghi	25
DEAN Forbici per tonsille	9
DENHART Apribocca	36
DERF Port'aghi.....	24
DESMARRES Divaricatori a forma di sella	18
DIAMANT Pinzette telescopiche per coronas.....	123
DINGMANN Apribocca	38
Distributore per spazzolini	41
Divaricatori.....	19-22
Divaricatori per guance e labbra.....	34
Divaricatori universale	35
DOYEN-JANSEN (MOLT) Apribocca	36
DUMONT Tenaglie piatte.....	127

E

Escavatore.....	93-95
Estensore per trattamenti canalari.....	97
Estensore per corona	121

F

FAHNENSTOCK Coltello per gesso..	120
FARABEUF Divaricatori.....	19
FARRELL porta cotone.....	23
FEDI Sgorbia per parodontologia	81
FELT Strumento composito	99
Fissatore per corona.....	121
FLOHR Leve per radici.....	60-61
FOERSTER Pinze per spugne.....	17
Forbici.....	6-10
Forbici delicate	10
Forbici per chirurgia.....	6, 8
Forbici per dissezione.....	7-8
Forbici per gengiva	10
Forbici per legature.....	9
Forbici per tenotomia.....	8
Forbici per tonsille	9
Forbici per unghie.....	40
FRAHM Strumento per modellare	117
FRAZIER Uncini per nervi e divaricatori fini.....	18
FRAZIER/FERGUSON tubi d aspirazione	31
Frese carotatrici trephine.....	133
FRIEDMAN Pinze sgorbie	29
FRIEDMAN Leve per radici	62
FRIEDMAN Mini Pinze sgorbie	29
FURRER Tenaglie	130

G

GILLIES Pinze per dissezione con denti.....	11
GILLIES Uncini per nervi e divaricatori fini.....	18
GISY-WILD Coltello per gesso	120
GOLDMAN-FOX Ablatore di tartaro	79
GOLDMAN-FOX Bisturi.....	80
GOLDMAN-FOX Forbici per gengiva.....	10
GOLDMAN-FOX Sonda parodontali.....	88-90
GOLDSTEIN Strumento composito	99
GOSLEE Tenaglie per profili	127
GRACEY (MINI) Curette.....	85
GRACEY (RIGID) Curette	86

GRACEY Curette.....	84
GRAEFE Uncini per nervi e divaricatori fini.....	18
GREEN Divaricatori.....	20
GRITMANN Coltello per gesso.....	120
GROSS-MAIER Pinze per tamponi e per medicazione	17
GUTHRIE Uncini per nervi e divaricatori fini	18

H

HALSEY Port'aghi	24
HALSTED-MOSQUITO Pinze emostatiche	14
HARRIS Pinze per estrazione	54
HARTMANN Abassalingua.....	33
HARTMANN Pinze emostatiche.....	14
HEIDEBRINK Leve per frammenti	69
HEISTER Apribocca	36
HEMINGWAY Curette.....	70
HENAHAN Pinze per estrazione	53
HIRSCHFELD Lima e raspe per osso.....	82
HOLLENBACK Otturatore	102
HOLLENBACK Strumento modellare.....	117
HOW Tenaglie per corone	131
HYGIENIST Ablatore di tartaro.....	77
HYLIN Leve per radici	62
HYLIN Strumento per modellare	119

I

Inseri di diamante per pinzette telescopiche per corone	123
inserto in silicone per Apribocca	37
Inserto per Crown-Butler	122
IRIS Forbici per chirurgia.....	8
IVORY Pinze per uncini	108
IVORY Portamatrix	107
IVORY Uncino	109
IWANSON Calibro	2

J

JAQUETTE Ablatore di tartaro	76, 78
JENNINGS Apribocca.....	36
JOHNSON Tenaglie per corone	131
JONES Pinze fissatilis.....	16
JOSEPH Forbici per dissezione	8
JOSEPH Uncini per nervi e divaricatori fini.....	18

K

KELLY Forbici per dissezione.....	8
KERRISON Pinze taglienti per seno mascellare	30
KILNER Uncini cutanei	18
KIRKLAND Bisturi per gengivectomia	80
KLEIN Pinze per estrazione	52
KOCHER-LANGENBECK Divaricatori.....	20
Kofferdam	108-109
KRALLENHEBER Leve per radici	67
KRAMERS Curette Sinus-Lift.....	135

L

LA GRANGE Forbici per gengiva	10
LADMORE Obturateur.....	103
Lame di ricambio per Raschietto osso	134
Lame per bisturi.....	5
Lampade a spirito.....	143
LANGENBECK Divaricatori.....	20
LANGENBECK Proteggidita.....	32
LANGER Curette	83
LAWRENCE-READ Pinze per estrazione.....	47, 51
Le CRON Strumento per modellare.....	119
LECLUSE Leve per radici	66
LERICHE Pinze emostatiche.....	15
Leve per frammenti.....	68-69
Leve per radici.....	60-63, 65-67
LEXER Forbici per dissezione.....	8
LICHTENBERG Port'aghi.....	25
LICHTENSTEIN Spatola	115
Lime e raspe per osso.....	82
Lima periodontale	82
Limette per le unghie	40
LINDO-LEVIAN Leve per radici	61
LITTAUER Forbici per legature	9
LOCKLIN Forbici per gengiva.....	10
LONDON-COLLEGE Pinze dentali	13
LUCAS Curette taglienti	71
Lucidatore.....	100
LUER Pinze sgorbie	29
LUNIATSCHEK Tamponatori.....	23
Luxatori.....	64

M

Manici per lama bisturi.....	3-4
Manico per specchietti.....	74

MARKLEY Otturatore	102
Martelli.....	27
MATHIEU Port'aghi	25
Matrice.....	107
MAUNDER Apribocca.....	32
MAYFIELD Pinze sgorbie	29
MAYO Spilloni per sterilizzazione.....	136
MAYO-HABERISSER Pinze per ritorcere fili.....	126
MAYO-HEGAR Port'aghi	25
McCALL Curette	83
McCALL Ablatore di tartaro	77
McIVOR Apribocca	39
MEAD Martillos	27
MERCITAN Ablatore di tartaro.....	79
MERCURY Sonda parodontali	88
MERCURY Strumento per modellare.....	116-119
MERIAM Pinze dentali.....	13
MERRIT A Sonda parodontali.....	88
MERSHON Dispositivo di azionamento	121
METZENBAUM Forbici per dissezione.....	7
METZENBAUM-FINO Forbici per dissezione.....	7
MICHIGAN Sonda parodontali	88-89
MICHIGAN Sonda	90
MILLER Pinzette per carta	120
MILLER Raspa	26
MILLER-APEXO Leve per radici	60
MILLER-COLBURN Curette	71
MINI-LAMBOTTE Osteotomia.....	27
MITCHELL Ablatori di tartaro.....	76
MIXTER-BABY Pinzas hemostáticas ..	16
MOLT Periostotomi.....	28

N

NABERS Sonda di forzazione.....	87
NABERS Sonda	92
NEVIUS Pinze per estrazione	56
NORTHBENT Forbici per legature	9
NYSTROEM Strumento per modellare	117

O

Obturateur	102-103
OBWEGESER Divaricatori.....	21-22
OBWEGESER Periostotomi.....	28
OCHSENBEIN Sgorbia	81
ORBAN Bisturi per gengivectomia	80

ORBAN Lima periodontale82
 Osteotomia27
 Otturatore97, 100, 102
 Otturatore a piede di elefante100
 Otturatore a sfera100
 Otturatore per trattamenti canalari97
 Otturatore piano 101-103

P

P.K. THOMAS Strumento
 per modellare..... 116
 Panno145
 PARMLY Pinze per estrazione.....54
 PARTSCH Osteotomia27
 PEAN Pinze emostatiche15
 PEET Pinze per schegge13
 Periototomi.....28
 Pinza coperchio.....138
 Pinza per levare bande.....128
 Pinza per tagliare filo.....125
 Pinza per tecnica128
 Pinza tecnica per filo128
 Pinza tecnica per piegare
 forma arco129
 Pinza tiralingua.....34
 Pinze.....11-13
 Pinze dentali.....13
 Pinze emostatiche14-16
 Pinze fissateli.....16
 Pinze per estrazione
 forma americana..... 53-59
 Pinze per afferrare
 intestino e tessuti.....17
 Pinze per dissezione
 chirurgiche anatomiche11-12
 Pinze per estrazione.....59
 Pinze per estrazione per denti
 canini e denti premolari47
 Pinze per estrazione per denti
 del giudizio..... 46-47, 57
 Pinze per estrazione per
 denti e radici55, 57, 59
 Pinze per estrazione per
 denti incisivi 52-53
 Pinze per estrazione per denti incisivi e
 denti premolari profondo.....44
 Pinze per estrazione per denti
 incisivi e denti canini..... 42, 50, 52-53
 Pinze per estrazione per
 denti incisivi e radici.....46, 50, 55
 Pinze per estrazione per denti incisivi
 laterali e denti premolari42

Pinze per estrazione per
 denti molari..... 43, 46, 48, 50-52, 56, 59
 Pinze per estrazione per
 denti molari e denti del giudizio53
 Pinze per estrazione per
 denti molari e denti premolari54
 Pinze per estrazione per
 denti premolari..... 42, 44-45, 50, 52
 Pinze per estrazione per denti
 premolari, denti incisivi e radici..... 56-57
 Pinze per estrazione
 forma inglese 42-51
 Pinze per estrazione per
 frammenti di radici 48-49, 55, 57
 Pinze per estrazione per
 radici44-45, 47-49, 51-52
 Pinze per estrazione per
 radici e denti incisivi.....43
 Pinze per la sterilizzazione136
 Pinze per spugne.....17
 Pinze per tamponi
 e per medicazione17
 Pinze per tessuti.....17
 Pinze sgorbie..... 29-30
 Pinzette telescopiche per coronas.....123
 Porta cotoni23
 Portaimpronta110-114
 Portaimpronta per funzionali
 nella mascella.....112-113
 Portaimpronta per mascella
 parzialmente 110, 112
 Portaimpronte parziali.....114
 Portamatrici e matrici.....107
 POTT Leve per radici67
 PRICHARD Curetta ossea87

R

RAMUS Divaricatori.....22
 Raschietto osso134
 Raspa26
 Recipienti..... 142-143
 Recipienti cilindrici142
 REDA Divaricatori.....19
 REYNOLDS Tenaglie per corone131
 RHODES Sgorbia.....81
 ROCHESTER-PEAN
 Pinze emostatiche15
 ROSER-KOENIG Apribocca.....36
 ROUX-BABY Divaricatori19
 RUSKIN Pinzas-gubias30

S

SAUERBRUCH Pinza per rifiuti.....136
 Scalpelli81-82
 Scatole per magazzinaggio140
 Scatole per sterilizzare aghi138
 Scatole per strumenti.....139
 SCHAEDEL Pinze fissateli16
 SCHWARZ Tenaglie129
 Scondelle.....141
 SELDIN Leve per radici60
 Sgorbie per parodontologia81
 Siringa ampollare a cilindro72
 Siringa di iniezione73
 Siringa per acqua72
 Siringhe72
 Sonde90-92
 Sonde a bottone23
 Sonde parodontali88-90
 Spatola104-105
 Spatola per cemento106
 Spazzole per pulire.....137
 Spazzole per unghie.....41
 Specchi laringei75
 Specchietto piano74
 SPENCER Forbici per legature9
 SPINA-NASALIS Divaricatori22
 Sputacchiera.....143
 STERNBERG Divaricatori
 per guance e labbra.....34
 STEVENS Forbici per tenotomia8
 STIEGLITZ Pinze per schegge.....13
 STOCKES Pinze per uncini.....108
 Strumenti per corone..... 121-123
 Strumenti per esaminare e misurare1
 Strumenti per fili di retrazione115
 Strumenti per trattamenti canalari97
 Strumento composito..... 98-99
 Strumento per
 schiacciamento ossa132
 Strumento per modellare116-120

T

Tagliasmalto.....96
 TANNER Otturatore.....102
 Tappetto in silicone.....145
 Telaio di fissaggio145
 Tasto esagonale123
 TAYLOR Ablatore di tartaro77
 TAYLOR Pinze per dissezione11
 Tenaglie125
 Tenaglie per afferrare i fili126

Tenaglie per corone.....	131
Tenaglie per la piegatura di staffe.....	129
Tenaglie per la rimozione di ponticelli.....	130
Tenaglie per profili	127, 131
Tenaglie piatte	126-127
Tenaglie universali.....	130
TOBOLD Divaricatori per guance e labbra.....	34
TOENNIS-ADSON Forbici per dissezione.....	9
TOFFLEMIRE Matrice	107
Togliilama	5
TOLSDORF Strumento per schiacciamento ossa.....	132
TOMES Pinze per estrazione	55
TOWNER Ablatore di tartaro	77
TOWNLEY Calibro	1
TREYEMANN Estrattore per corona	122
Tronchese taglienti	124
Tronchesine per unghie e pelle	40
Tronchesini per unghie	40
TWEED Pinza tecnica per filo	128
uncini	109

U

UNIVERSAL Forbici per filo di metallo	9, 124
USA Pinze foradiga	108

V

Vaso di amalgama.....	98
VIRTUS (RALK) Pinze per schegge....	13
VOLKMANN Curette taglienti	26

W

W.F. BARRY Leve per radici.....	65
WAGNER Forbici delicate	10
WALDSACHS Tenaglie universali	130
WARD Obturateur	103
WARD Strumento per modellare	117
WARD-KIRKLAND Ablatore di tartaro.....	79
WARWICK-JAMES Leve per frammenti	68
Wattedosen	143
WEBSTER Port'aghi.....	24
WEINGART Pinza per tecnica.....	128
WEISS-CASTROVIEJO Calibro	2
WEST Leve per frammenti	68

WHITE Ablatore di tartaro.....	79
WHITE Sonde.....	91
WHO Sonde parodontali.....	88
WIEDER Abassalingua.....	33
WILLIAMS Sonde parodontali	89-90
WILLIAMS-GOLDMAN-FOX Sonde parodontali	89
WILLIGER Curette taglienti	26
WILLIGER Elévateur	28
WILLIGER Martelli.....	27
WINTER Leve per radici.....	66
WITZEL Pinze per estrazione.....	58
WIZARD Supporto.....	109

Y

YOUNG Pinza tiralingua.....	34
YOUNG Pinze a forma di loop.....	129
YOUNGER-GOOD Ablatori di tartaro	76

Z

ZAHLE Strumento per modellare	119
ZAUFAL-JANSEN Pinzas-gubias.....	30

Hauptkatalog Chirurgische Instrumente
General catalog surgical instruments

HNO
ENT

Arthroskopie
Arthroscopy

Container Steriltechnik
Container Sterilization Technique

Endoskopie
Endoscopy

HERCULES® Drahtkneifzange
HERCULES® Wire Cutters

Neurochirurgie
Neuro Surgery

Orthopädie
Orthopedic

Titan Instrumente
Titanium Instruments

+Redamed

Maltepe Mah.
Eski Çırpıcıyolu Sk.
Merter İş Merkezi D Blok
2/21 034234
Zeytinburnu, İstanbul

+90 212 482 71 52
info@redamed.com

