



**+Redamed**





Maltepe Mah.Eski ırpıcıyolu Sk.  
Merter İş Merkezi D Blok 2/21  
034234- Zeytinburnu, İstanbul

+90 212 482 71 52  
info@redamed.com

Endoskope für Arthroskopie  
Endoscopes for Arthroscopy  
Endoscopios para artroscopía

**Ø 4 mm**

Arthroskop, autoklavierbar mit integrierter Faser zur Beleuchtung für diagnostische und operative Eingriffe, Ø 4 mm, Arbeitslänge 175 mm:  
Knie, Perkutane Nukleotomie, lumbaler Bandscheibenvorfall, für Schulter-Arthroskopie.

Arthroscope, autoclavable, with integrated fiber optic for illumination, for diagnostic and operation, Ø 4 mm, working length 175 mm:  
Knee, percutaneous nucleotomy, shoulder arthroscopy.

Artroscopios (ópticas) autoclavables con fibroptica incorporado para intervenciones diagnósticas y operativas, diámetro de 4 mm, largo útil 175 mm:  
rodilla, nucleotomía percutánea, hernias lumbales y artroscopía de la espalda y hombro.

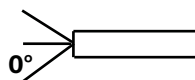
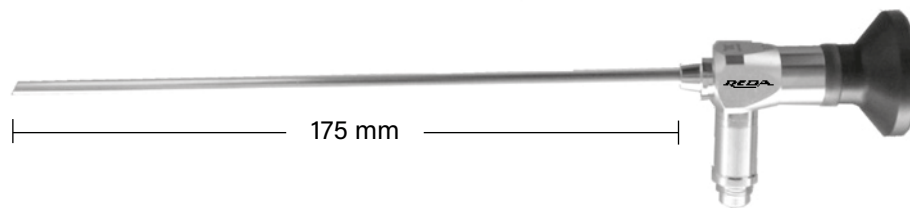

Geradeausblick  
Direct vision  
Vision directa

**R400-040175-000**

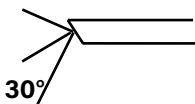

Vorausblick  
Foroblique vision  
ángulo de

**R400-040175-030**

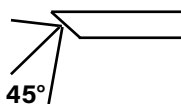

Vorausblick  
Foroblique vision  
ángulo de

**R400-040175-045**

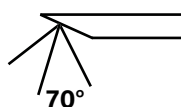

Seitblick  
Lateral vision  
ángulo de

**R400-040175-070**

Arthroskopieschäfte für Endoskope mit Ø 4 mm  
 Arthroscopy Sheath for endoscopes with Ø 4 mm  
 Vainas para artroscopia para endoscopios de Ø 4 mm

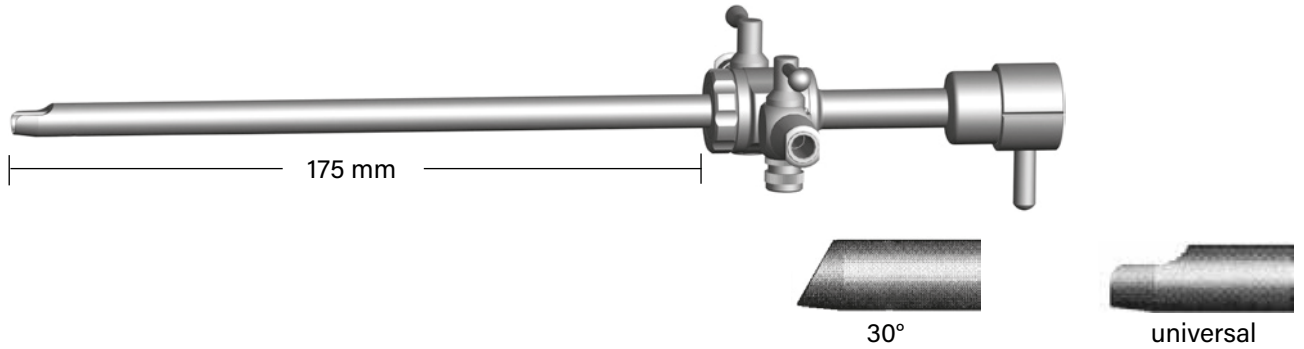

Trokar-Hülse mit zwei Spülhähnen, drehbar, 4 mm Ø  
 Trocar sleeve, with two stop cocks rotating, 4 mm Ø  
 Tubo con dos llaves giratorias, de 4 mm Ø

**R414-040175-030**

**R414-040175-070**

mit einem Spülhahn drehbar  
 with one stop cock rotating  
 con una llave giratoria

**R413-040175-030**

**R413-040175-070**

**Obturator 4 mm Ø**  
**Obturator 4 mm Ø**  
**Obturador de 4 mm Ø**



scharf / sharp / agudo

**R410-040175-001**



konisch stumpf / conical blunt / cónico romo

**R410-040175-002**



stumpf / blunt / romo

**R410-040175-003**

Endoskope für Arthroskopie  
Endoscopes for Arthroscopy  
Endoscopios para artroscopía

**Ø 2,7 mm**

Arthroskop, autoklavierbar mit integrierter Faser zur Beleuchtung für diagnostische und operative Eingriffe,  
Ø 2,7 mm, Arbeitslänge 110 mm:  
Kleine Gelenke und Karpaltunnel

Arthroscope, autoclavable, with integrated fiber optic for illumination, for diagnostic and operation,  
Ø 2.7 mm, working length 110 mm:  
small joints and carpal tunnel

Artroscopios (ópticas) autoclavables con fibraoptica incorporado para intervenciones diagnósticas y operativas,  
diámetro de 2,7 mm, largo útil 110 mm:  
articulaciones pequeñas

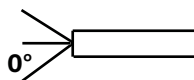
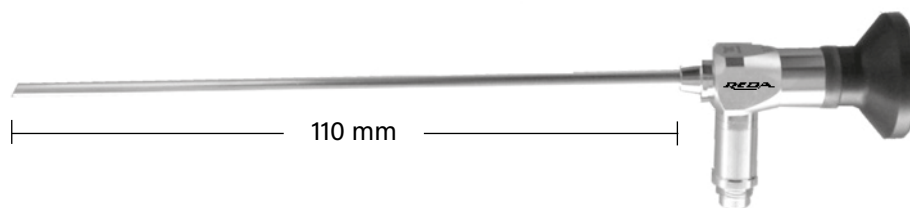

Geradeausblick  
Direct vision  
Vision directa

**R400-027110-000**

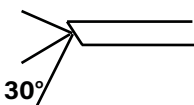

Vorausblick  
Foroblique vision  
ángulo de

**R400-027110-030**

Arthroskopieschäfte für Endoskope mit Ø 2,7 mm  
 Arthroscopy Sheath for endoscopes with Ø 2,7 mm  
 Vainas para artroscopia para endoscopios de Ø 2,7 mm

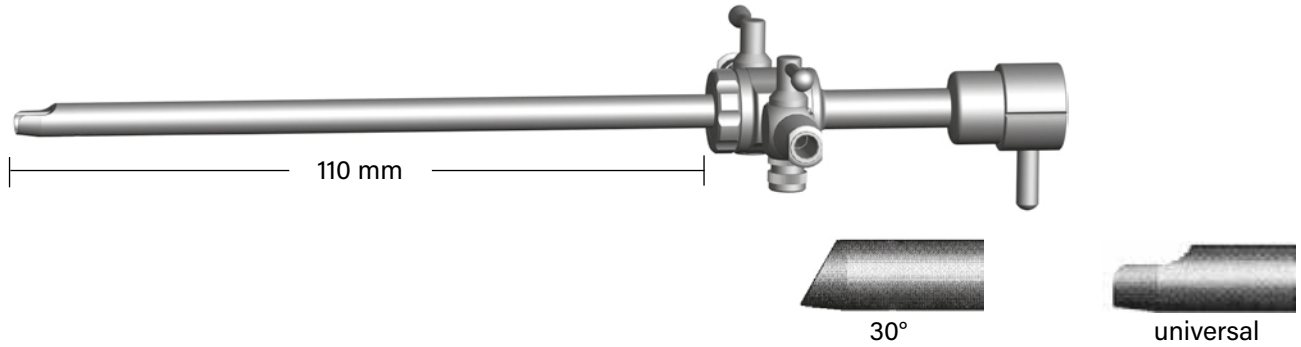

Trokar-Hülse mit zwei Spülhähnen, drehbar, 2,7 mm Ø  
 Trocar sleeve, with two stop cocks rotating, 2.7 mm Ø  
 Tubo con dos llaves giratorias, de 2,7 mm Ø

**R414-027110-030**

**R414-027110-070**

mit einem Spülhahn drehbar  
 with one stop cock rotating  
 con una llave giratoria

**R413-027110-030**

**R413-027110-070**

**Obturator 2,7 mm Ø**  
**Obturator 2.7 mm Ø**  
**Obturador de 2,7 mm Ø**



scharf / sharp / agudo

**R410-027110-001**



konisch stumpf / conical blunt / cónico romo

**R410-027110-002**



stumpf / blunt / romo

**R410-027110-003**

Endoskope für Arthroskopie  
Endoscopes for Arthroscopy  
Endoscopios para artroscopía

**Ø 2,7 mm**

Arthroskop, autoklavierbar mit integrierter Faser zur Beleuchtung für diagnostische und operative Eingriffe,  
Ø 2,7 mm, Arbeitslänge 175 mm:  
Kleine Gelenke

Arthroscope, autoclavable, with integrated fiber optic for illumination, for diagnostic and operation,  
Ø 2.7 mm, working length 175 mm:  
small joint

Artroscopios (ópticas) autoclavables con fibraoptica incorporado para intervenciones diagnósticas y operativas,  
diámetro de 2,7 mm, largo útil 175 mm:  
articulaciones pequeñas

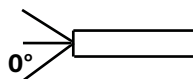
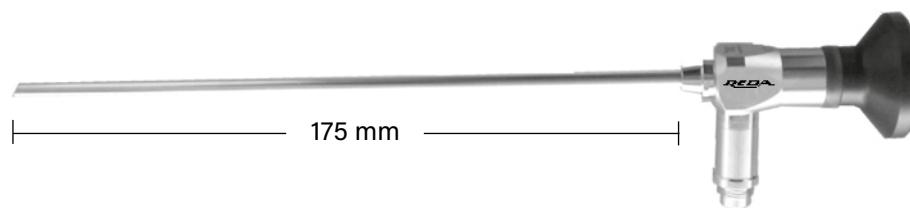

Geradeausblick  
Direct vision  
Vision directa

**R400-027175-000**

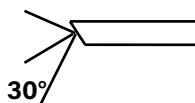

Vorausblick  
Foroblique vision  
ángulo de

**R400-027175-030**

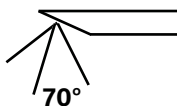

Seitblick  
Lateral vision  
ángulo de

**R400-027175-070**



Arthroskopieschäfte für Endoskope mit Ø 2,7 mm  
 Arthroscopy Sheath for endoscopes with Ø 2,7 mm  
 Vainas para artroscopia para endoscopios de Ø 2,7 mm

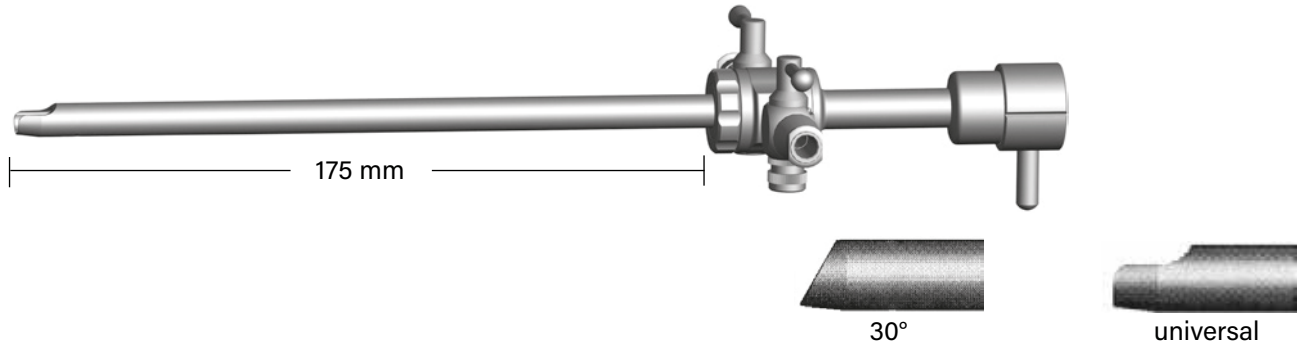

Trokar-Hülse mit zwei Spülhähnen, drehbar, 2,7 mm Ø  
 Trocar sleeve, with two stop cocks rotating, 2.7mm Ø  
 Tubo con dos llaves giratorias, de 2,7 mm Ø

**R414-027175-030**

**R414-027175-070**

mit einem Spülhahn drehbar  
 with one stop cock rotating  
 con una llave giratoria

**R413-027175-030**

**R413-027175-070**

**Obturator 2,7 mm Ø**  
**Obturator 2.7 mm Ø**  
**Obturador de 2,7 mm Ø**



scharf / sharp / agudo

**R410-027175-001**



konisch stumpf / conical blunt / cónico romo

**R410-027175-002**



stumpf / blunt / romo

**R410-027175-003**

Endoskope für Arthroskopie  
Endoscopes for Arthroscopy  
Endoscopios para artroscopía

**Ø 2,7 mm**

Arthroskop, autoklavierbar mit integrierter Faser zur Beleuchtung für diagnostische und operative Eingriffe,  
Ø 2,7 mm, Arbeitslänge 188 mm:  
Schulter

Arthroscope, autoclavable, with integrated fiber optic for illumination, for diagnostic and operation,  
Ø 2.7 mm, working length 188 mm:  
shoulder

Artroscopios (ópticas) autoclavables con fibraoptica incorporado para intervenciones diagnósticas y operativas,  
diámetro de 2,7 mm, largo útil 188 mm:  
hombro

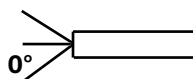
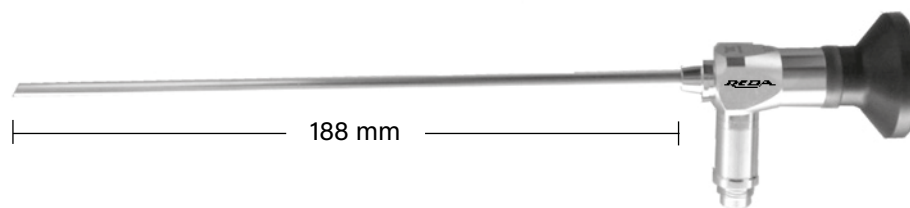

Geradeausblick  
Direct vision  
Vision directa

**R400-027188-000**

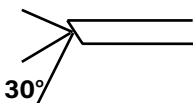

Vorausblick  
Foroblique vision  
ángulo de

**R400-027188-030**

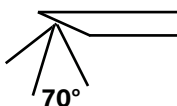

Seitblick  
Lateral vision  
ángulo de

**R400-027188-070**

Arthroskopieschäfte für Endoskope mit Ø 2,7 mm  
 Arthroscopy Sheath for endoscopes with Ø 2,7 mm  
 Vainas para artroscopia para endoscopios de Ø 2,7 mm

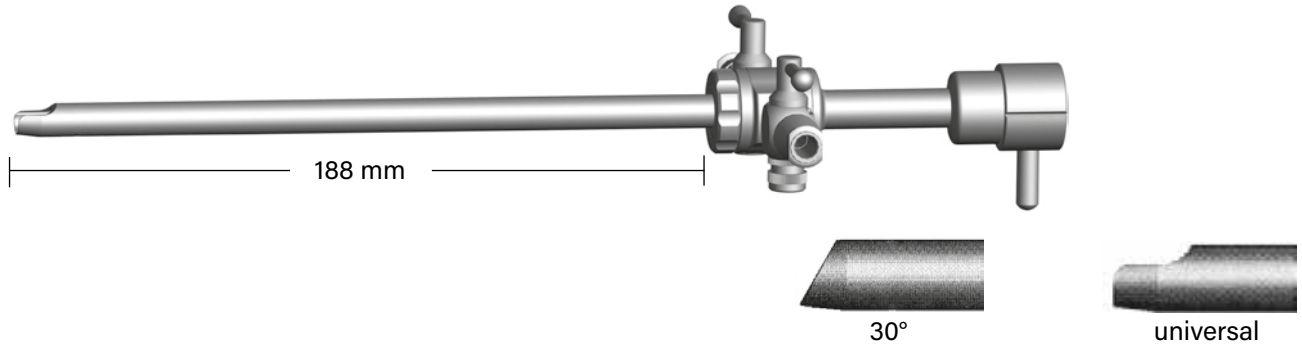

Trokar-Hülse mit zwei Spülhähnen, drehbar, 2,7 mm Ø  
 Trocar sleeve, with two stop cocks rotating, 2.7mm Ø  
 Tubo con dos llaves giratorias, de 2,7 mm Ø

**R414-027188-030**

**R414-027188-070**

mit einem Spülhahn drehbar  
 with one stop cock rotating  
 con una llave giratoria

**R413-027188-030**

**R413-027188-070**

**Obturator 2,7 mm Ø**  
**Obturator 2.7 mm Ø**  
**Obturador de 2,7 mm Ø**



scharf / sharp / agudo

**R410-027188-001**



konisch stumpf / conical blunt / cónico romo

**R410-027188-002**



stumpf / blunt / romo

**R410-027188-003**

Hakenstanze, mit Schippe  
 Hook punch, scoope nose  
 Pinza cortante, de nariz aguda

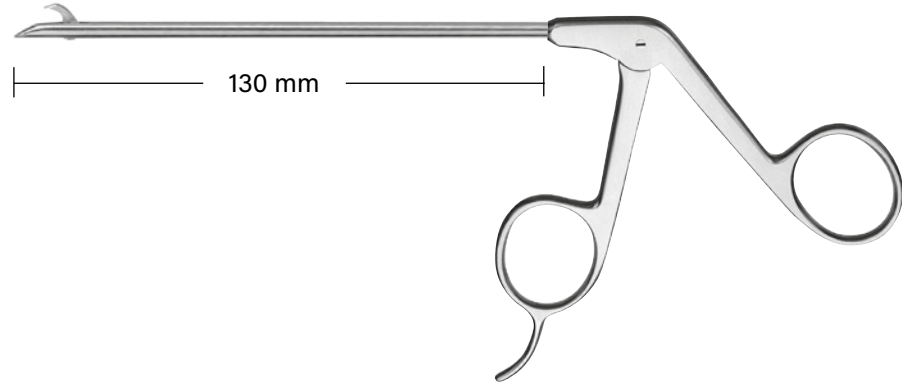

Hakenstanze mit Schippe  
 Hook punch, scoope nose  
 Pinza cortante, de nariz aguda

gerade / straight / recta

3,4 mm Ø  
 cutting size 5 x 1,6

2,8 mm Ø  
 cutting size 4 x 1,2

**R440-034130-000**

**R440-028130-000**



30°

Schaft gebogen / shaft curved  
 vaina curva:

rechts / right / derecha

**R440-034130-030**

**R440-028130-030**

links / left / izquierda

**R440-034130-130**

**R440-028130-130**



45°

rechts / right / derecha

**R440-034130-045**

**R440-028130-045**

links / left / izquierda

**R440-034130-145**

**R440-028130-145**



7°

aufwärts / upwards  
 hacia arriba

**R440-034130-007**

**R440-028130-007**



abwärts / downwards  
 hacia abajo

**R440-034130-107**

**R440-028130-107**



15°

aufwärts / upwards  
 hacia arriba

**R440-034130-015**

**R440-028130-015**





abwärts / downwards  
 hacia abajo

**R440-034130-115**

**R440-028130-115**

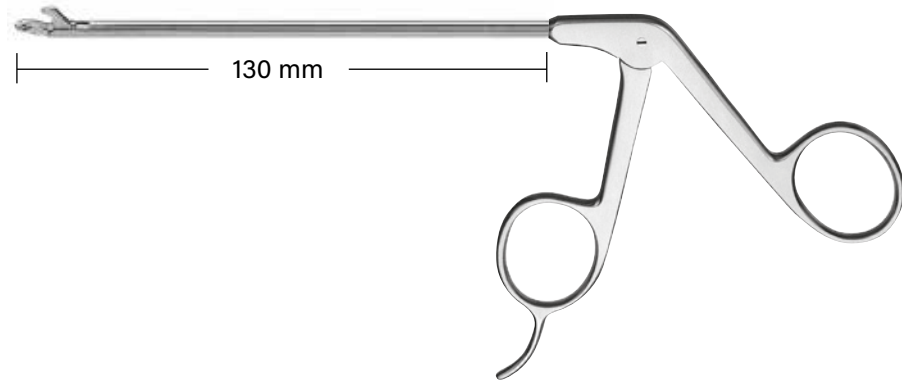
Hakenstanze, mit Schippe 15°  
 Hook punch, scoope nose 15°  
 Pinza cortante, de nariz aguda 15°

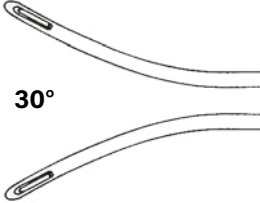
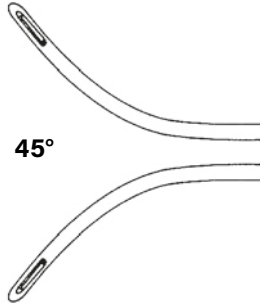
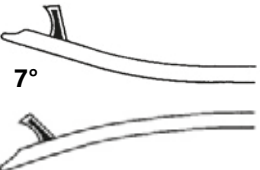
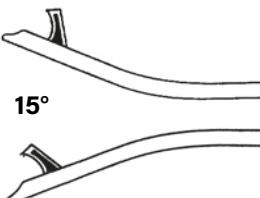

		3,4 mm Ø cutting size 5 x 1,6	2,8 mm Ø cutting size 4 x 1,2
	Hakenstanze mit Schippe Hook punch, scoope nose Pinza cortante, de nariz aguda  gerade / straight / recta	<b>R440-034130-200</b>	<b>R440-028130-200</b>
	Schaft gebogen / shaft curved vaina curva:		
	rechts / right / derecha links / left / izquierda	<b>R440-034130-230</b> <b>R440-034130-330</b>	<b>R440-028130-230</b> <b>R440-028130-330</b>
	rechts / right / derecha links / left / izquierda	<b>R440-034130-245</b> <b>R440-034130-345</b>	<b>R440-028130-245</b> <b>R440-028130-345</b>
		aufwärts / upwards hacia arriba abwärts / downwards hacia abajo	<b>R440-034130-207</b> <b>R440-034130-307</b>
		aufwärts / upwards hacia arriba abwärts / downwards hacia abajo	<b>R440-034130-215</b> <b>R440-034130-315</b>

Hakenstanze, stumpf  
 Hook punch, blunt nose  
 Pinza cortante, de nariz roma

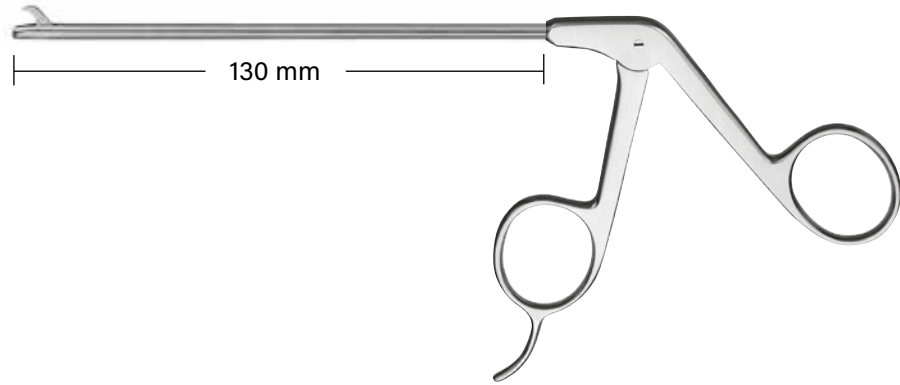

Hakenstanze, stumpf  
 Hook punch, blunt nose  
 Pinza cortante, de nariz roma

gerade / straight / recta

3,4 mm Ø  
 cutting size 5 x 1,6

2,8 mm Ø  
 cutting size 4 x 1,2

**R441-034130-000**

**R441-028130-000**



30°

Schaft gebogen / shaft curved  
 vaina curva:

rechts / right / derecha

**R441-034130-030**

**R441-028130-030**

links / left / izquierda

**R441-034130-130**

**R441-028130-130**



45°

rechts / right / derecha

**R441-034130-045**

**R441-028130-045**

links / left / izquierda

**R441-034130-145**

**R441-028130-145**



7°

aufwärts / upwards  
 hacia arriba

**R441-034130-007**

**R441-028130-007**



abwärts / downwards  
 hacia abajo

**R441-034130-107**

**R441-028130-107**



15°

aufwärts / upwards  
 hacia arriba

**R441-034130-015**

**R441-028130-015**



abwärts / downwards  
 hacia abajo

**R441-034130-115**

**R441-028130-115**

Hakenstanze, stumpf 15°  
 Hook punch, blunt nose 15°  
 Pinza cortante, de nariz roma 15°

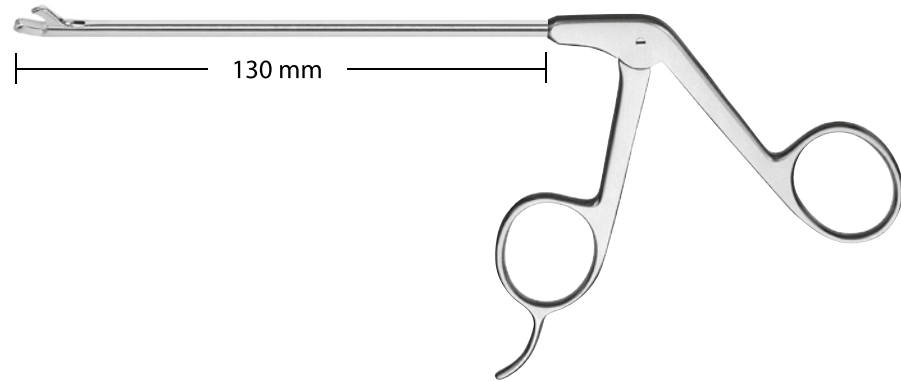

3,4 mm Ø  
 cutting size 5 x 1,6

2,8 mm Ø  
 cutting size 4 x 1,2

	Hakenstanze, stumpf Hook punch, blunt nose Pinza cortante, de nariz roma	gerade / straight / recta	<b>R441-034130-400</b>	<b>R441-028130-400</b>
	Schaft gebogen / shaft curved vaina curva:	rechts / right / derecha	<b>R441-034130-430</b>	<b>R441-028130-430</b>
		links / left / izquierda	<b>R441-034130-630</b>	<b>R441-028130-630</b>
		rechts / right / derecha	<b>R441-034130-445</b>	<b>R441-028130-445</b>
		links / left / izquierda	<b>R441-034130-645</b>	<b>R441-028130-645</b>
		aufwärts / upwards hacia arriba	<b>R441-034130-407</b>	<b>R441-028130-407</b>
		abwärts / downwards hacia abajo	<b>R441-034130-607</b>	<b>R441-028130-607</b>
		aufwärts / upwards hacia arriba	<b>R441-034130-415</b>	<b>R441-028130-415</b>
		abwärts / downwards hacia abajo	<b>R441-034130-615</b>	<b>R441-028130-615</b>

Stanze, gezahnt, slim  
 Punch, serrated, slim  
 Pinza cortante aserrada, slim

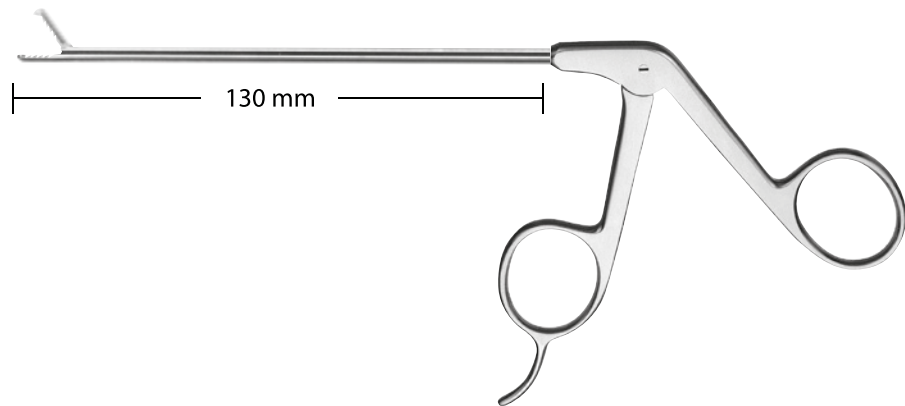

Stanze, gezahnt  
 Punch, serrated  
 Pinza cortante aserrada

gerade / straight / recta

3,4 mm Ø  
 cutting size 6 x 2

2,8 mm Ø  
 cutting size 5 x 1,6

**R442-034130-000**

**R442-028130-000**



30°

Schaft gebogen / shaft curved  
 vaina curva:

rechts / right / derecha

links / left / izquierda

**R442-034130-030**

**R442-028130-030**

**R442-034130-130**

**R442-028130-130**



45°

rechts / right / derecha

links / left / izquierda

**R442-034130-045**

**R442-028130-045**

**R442-034130-145**

**R442-028130-145**



7°

aufwärts / upwards  
 hacia arriba

**R442-034130-007**

**R442-028130-007**



abwärts / downwards  
 hacia abajo

**R442-034130-107**

**R442-028130-107**



15°

aufwärts / upwards  
 hacia arriba

**R442-034130-015**

**R442-028130-015**



abwärts / downwards  
 hacia abajo

**R442-034130-115**

**R442-028130-115**



Stanze, gezahnt „Duck“ Form  
 Punch, serrated, „Duck“ shaped  
 Pinza cortante, aserrada, pico de pato

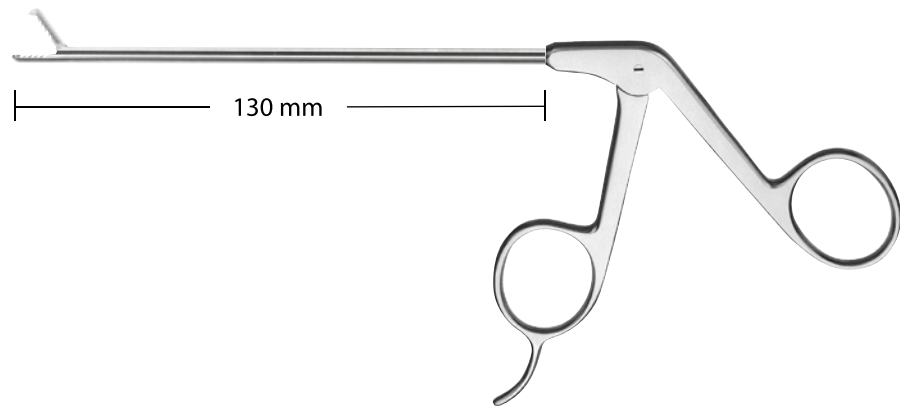

		3,4 mm Ø cutting size 6 x 2	2,8 mm Ø cutting size 5 x 1,6
	Stanze, gezahnt „Duck“ Form 15° Punch, serrated, „Duck“ shaped 15° Pinza cortante, aserrada, pico de pato 15°  gerade / straight / recta	<b>R441-034130-200</b>	<b>R441-028130-200</b>
	Schaft gebogen / shaft curved vaina curva: rechts / right / derecha	<b>R441-034130-230</b>	<b>R441-028130-230</b>
	links / left / izquierda	<b>R441-034130-330</b>	<b>R441-028130-330</b>
	rechts / right / derecha	<b>R441-034130-245</b>	<b>R441-028130-245</b>
	links / left / izquierda	<b>R441-034130-345</b>	<b>R441-028130-345</b>
	aufwärts / upwards hacia arriba	<b>R441-034130-207</b>	<b>R441-028130-207</b>
	abwärts / downwards hacia abajo	<b>R441-034130-307</b>	<b>R441-028130-307</b>
	aufwärts / upwards hacia arriba	<b>R441-034130-215</b>	<b>R441-028130-215</b>
	abwärts / downwards hacia abajo	<b>R441-034130-315</b>	<b>R441-028130-315</b>

Stanze, gezahnt, lang  
 Punch, serrated, long  
 Pinza cortante, larga

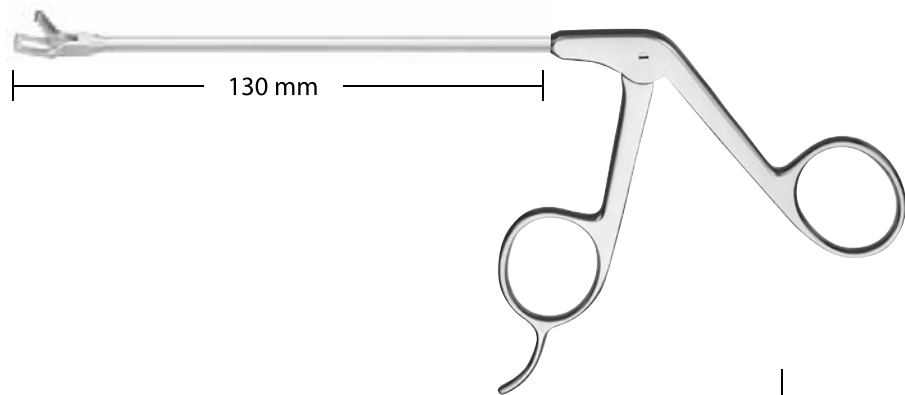

Standard



Duck

gerade / straight / recta



30°

Schaft gebogen / shaft curved  
 vaina curva:

rechts / right / derecha

links / left / izquierda

Standard

Duck" Form, 15°  
 Duck" shaped, 15°  
 pico de pato, 15°

3,4 mm Ø  
 cutting size 6 x 3,5

3,4 mm Ø  
 cutting size 6 x 3,5

**R444-034130-000**

**R444-034130-200**

**R444-034130-030**

**R444-034130-230**

**R444-034130-130**

**R444-034130-330**



45°

rechts / right / derecha

links / left / izquierda

**R444-034130-045**

**R444-034130-245**

**R444-034130-145**

**R444-034130-345**



7°

aufwärts / upwards  
 hacia arriba

**R444-034130-007**

**R444-034130-207**



abwärts / downwards  
 hacia abajo

**R444-034130-107**

**R444-034130-307**



15°

aufwärts / upwards  
 hacia arriba

**R444-034130-015**

**R444-034130-215**



abwärts / downwards  
 hacia abajo

**R444-034130-115**

**R444-034130-315**

Stanze, gezahnt, breit  
Punch, serrated, wide  
Pinza cortante, aserrada, ancha

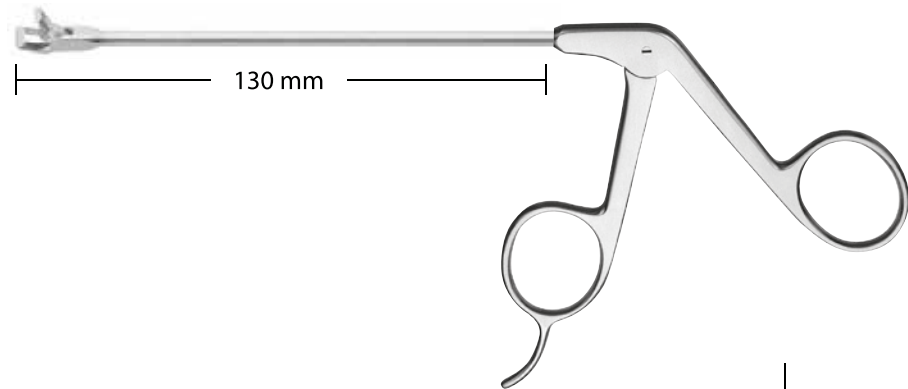

Standard



Duck

gerade / straight / recta



30°

Schaft gebogen / shaft curved  
vaina curva:

rechts / right / derecha

links / left / izquierda

Standard

Duck" Form, 15°  
Duck" shaped, 15°  
pico de pato, 15°

3,4 mm Ø  
cutting size 4 x 4

3,4 mm Ø  
cutting size 4 x 4

**R443-034130-000**

**R443-034130-200**

**R443-034130-030**

**R443-034130-230**

**R443-034130-130**

**R443-034130-330**



45°

rechts / right / derecha

links / left / izquierda

**R443-034130-045**

**R443-034130-245**

**R443-034130-145**

**R443-034130-345**



7°

aufwärts / upwards  
hacia arriba

**R443-034130-007**

**R443-034130-207**



abwärts / downwards  
hacia abajo

**R443-034130-107**

**R443-034130-307**



15°

aufwärts / upwards  
hacia arriba

**R443-034130-015**

**R443-034130-215**



abwärts / downwards  
hacia abajo

**R443-034130-115**

**R443-034130-315**

Stanze, gezahnt, extra breit  
 Punch, serrated, extra wide  
 Pinza cortante, aserrada, extra ancha

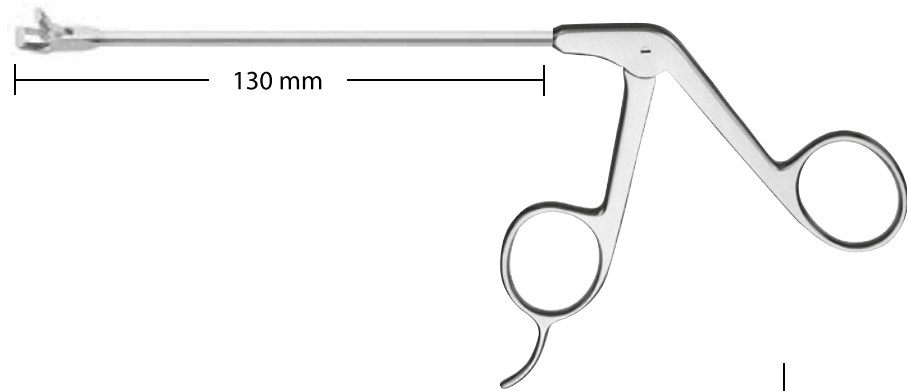

Standard



Duck

gerade / straight / recta



30°

Schaft gebogen / shaft curved  
 vaina curva:

rechts / right / derecha

links / left / izquierda



45°

rechts / right / derecha

links / left / izquierda



7°

aufwärts / upwards  
 hacia arriba

abwärts / downwards  
 hacia abajo



15°

aufwärts / upwards  
 hacia arriba

abwärts / downwards  
 hacia abajo



Standard

Duck" Form, 15°  
 Duck" shaped, 15°  
 pico de pato, 15°

3,4 mm Ø  
 cutting size 5 x 4,5

3,4 mm Ø  
 cutting size 5 x 4,5

**R446-034130-000**

**R446-034130-200**

**R446-034130-030**

**R446-034130-230**

**R446-034130-130**

**R446-034130-330**

**R446-034130-045**

**R446-034130-245**

**R446-034130-145**

**R446-034130-345**

**R446-034130-007**

**R446-034130-207**

**R446-034130-107**

**R446-034130-307**

**R446-034130-015**

**R446-034130-215**

**R446-034130-115**

**R446-034130-315**

Mikro-Stanze  
Slender Punch  
Micro pinza cortante

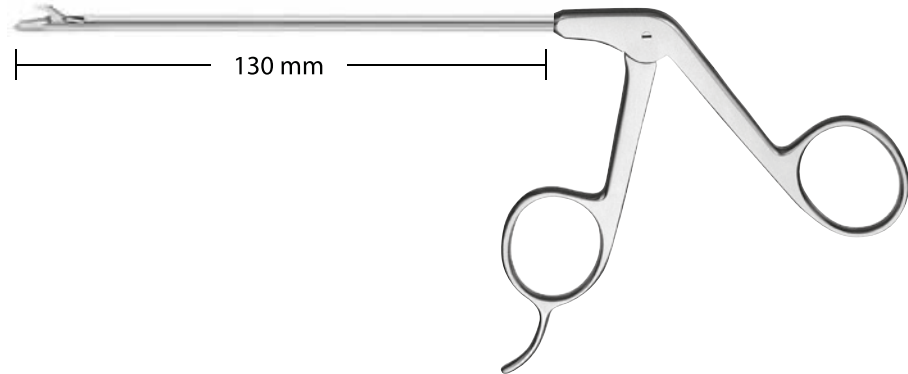

3,4 mm Ø  
cutting size 0,8 x 5.5 mm



gerade / straight / recta

**R447-034130-000**



**30°**

Schaft gebogen / shaft curved  
vaina curva:

rechts / right / derecha

**R447-034130-030**

links / left / izquierda

**R447-034130-130**



**45°**

rechts / right / derecha

**R447-034130-045**

links / left / izquierda

**R447-034130-145**



**7°**

aufwärts / upwards  
hacia arriba

**R447-034130-007**

abwärts / downwards  
hacia abajo

**R447-034130-107**

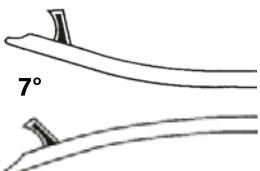

**15°**

aufwärts / upwards  
hacia arriba

**R447-034130-015**

abwärts / downwards  
hacia abajo

**R447-034130-115**

Stanze oval  
Oval Punch  
Pinza ovalada

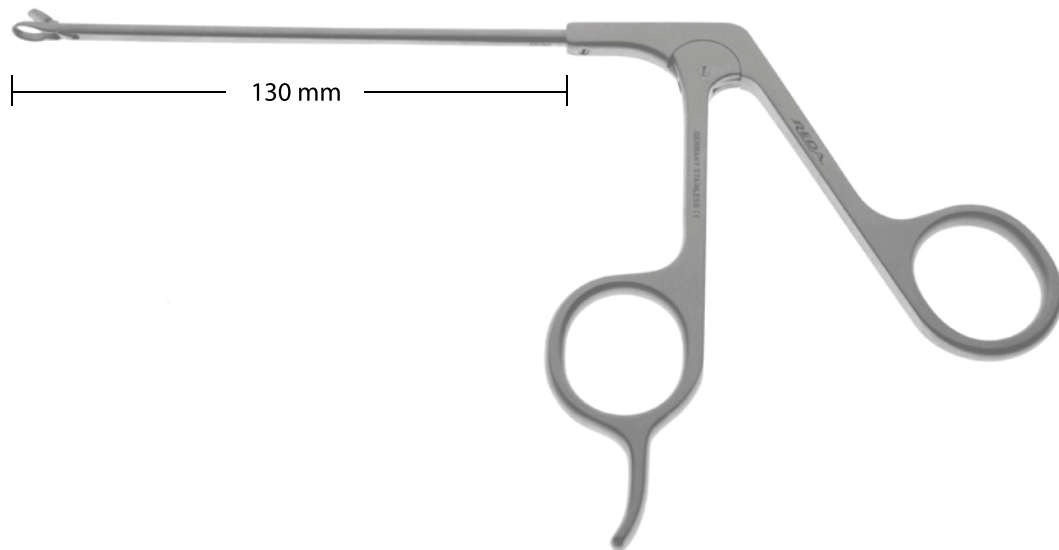

gerade / straight / recta

3,4 mm Ø  
cutting size 4,4 mm

**R448-034130-000**



rechts / right / derecha

**R448-034130-045**



links / left / izquierda

**R448-034130-145**



aufwärts / upwards / hacia arriba

**R448-034130-015**

aufgewinkelt / angled up / angulada hacia arriba

**R448-034130-200**

Stanzen  
Punches  
Pinzas cortantes

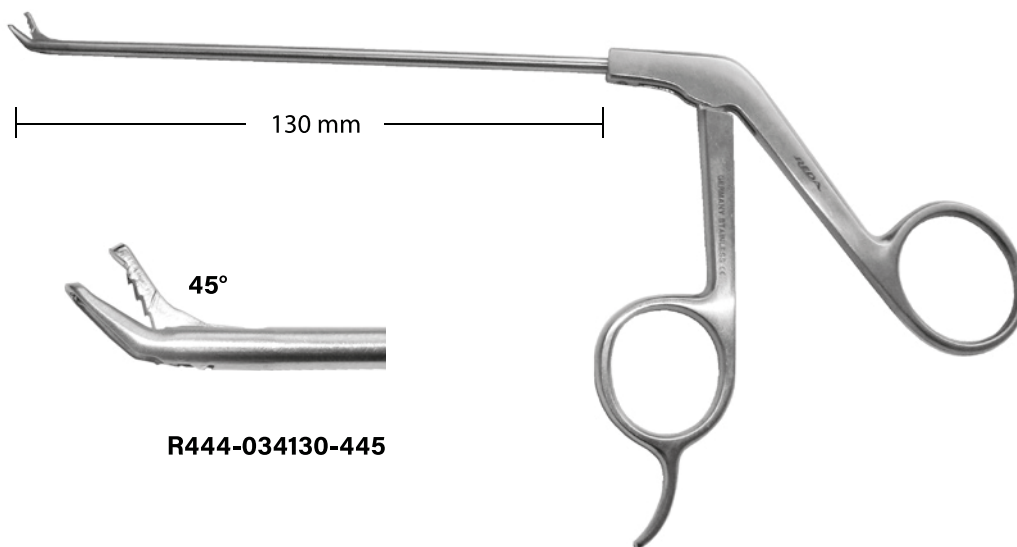

**R444-034130-445**

Biopsie-Stanze, 45° nach oben schneidend, 3,4 mm Ø  
Biopsy punch, 45° upcurved cutting, 3.4 mm Ø  
Pinza para biopsia, 45° corte hacia arriba, 3,4 mm Ø



cutting size 3,8 x 2,4

Antrumstanze durchschneidend, 3,5 mm Ø, 130 mm Nutzlänge  
Antrum punch through cutting, 3.5 mm Ø, 130 mm working length  
Pinza Antrum cortante, 3,5 mm Ø, largo útil de 130 mm

rechts / right / derecha



**R448-035130-600**

links / left / izquierda

**R448-035130-800**

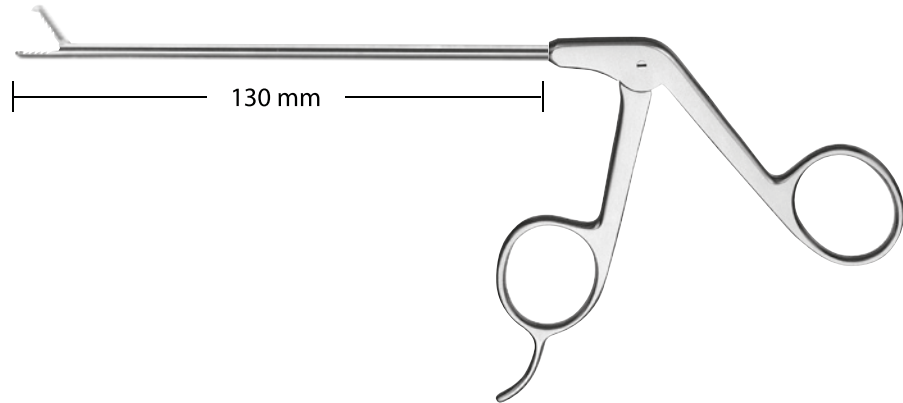
Biopsie-Stanze, seitlich schneidend 3,4 mm Ø  
 Biopsy punch, side-biter 3.4 mm Ø  
 Pinza para biopsia, corte lateral 3,4 mm Ø



		mit Schippe scoope nose de nariz aguda	stumpf blunt nose de nariz roma
Maulteil gewinkelt / jaw angled / boca angulada:			
 <b>90°</b> cutting size 5 x 1.6 mm	rechts / right / derecha	<b>R440-034130-590</b>	<b>R441-034130-590</b>
	links / left / izquierda	<b>R440-034130-790</b>	<b>R441-034130-790</b>
 <b>45°</b> cutting size 3,5 x 1.6 mm	rechts / right / derecha	<b>R440-034130-545</b>	<b>R441-034130-545</b>
	links / left / izquierda	<b>R440-034130-745</b>	<b>R441-034130-745</b>



Biopsie-Stanze, seitlich schneidend, breit  
 Biopsy punch, side-biter, wide  
 Pinza para biopsia, corte lateral, ancha

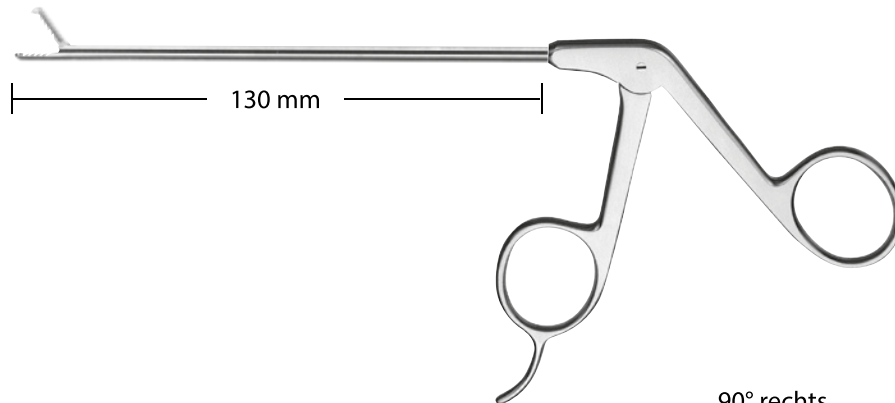

gerade / straight / recta

90° rechts  
 90° right  
 90° derecha

90° links  
 90° left  
 90° izquierda

3,4 mm Ø  
 cutting size 4 x 4

3,4 mm Ø  
 cutting size 4 x 4

**R443-034130-590**

**R443-034130-790**



30°

Schaft gebogen / shaft curved  
 vaina curva:

rechts / right / derecha

**R443-034130-530**

**R443-034130-730**

links / left / izquierda

**R443-034130-630**

**R443-034130-830**



45°

rechts / right / derecha

**R443-034130-545**

**R443-034130-745**

links / left / izquierda

**R443-034130-645**

**R443-034130-845**



7°

aufwärts / upwards  
 hacia arriba

**R443-034130-507**

**R443-034130-707**



abwärts / downwards  
 hacia abajo

**R443-034130-607**

**R443-034130-807**



15°

aufwärts / upwards  
 hacia arriba

**R443-034130-515**

**R443-034130-715**



abwärts / downwards  
 hacia abajo

**R443-034130-615**

**R443-034130-815**

Rotationszange, Schnittbreite 3,4 mm  
Rotary punch, cutting size 3,4 mm  
Pinza rotatoria, corte de 3,4 mm

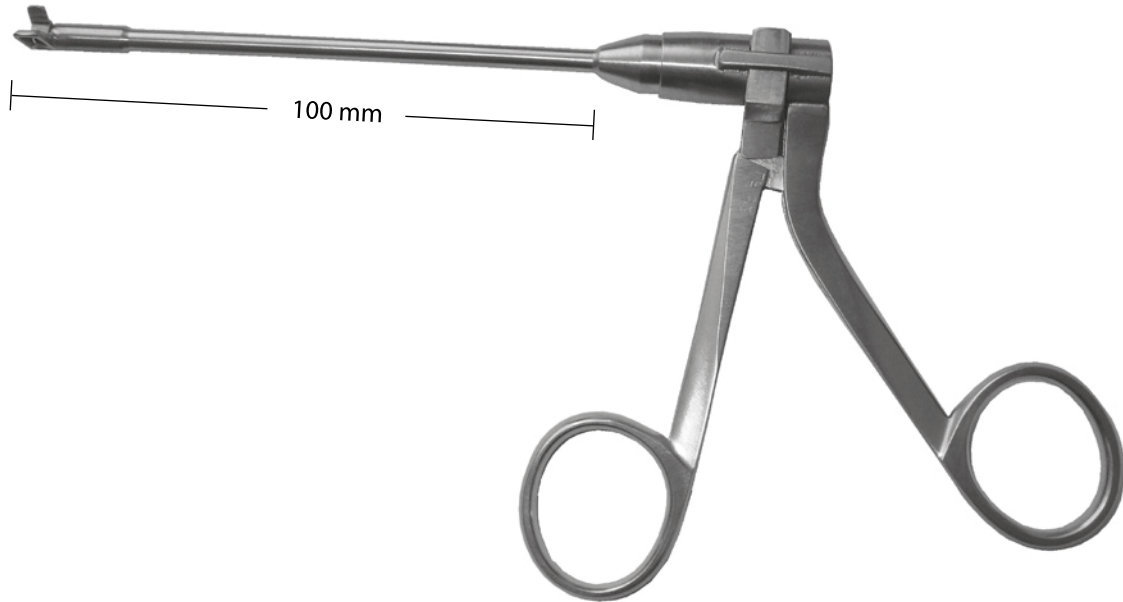

Rotationszange für große Schnitte  
100 mm Nutzlänge, Ringgriff Standard

Rotary punch for big cutting size  
100 mm working length, grip handle

Pinza rotatoria, para cortes grandes,  
largo útil de 100 mm, mango de anillo



90° rechts / right  
90° hacia la derecha

**R449-035100-090**





90° links / left  
90° hacia la izquierda

**R449-035100-190**

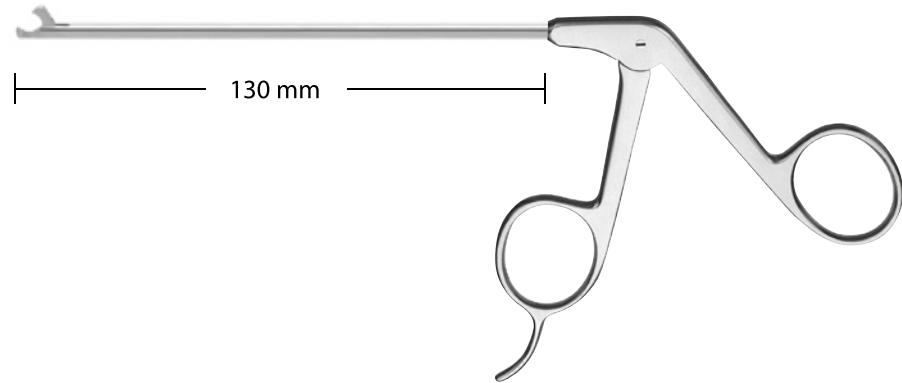
Hakenschere  
Hook scissors  
Tijera en forma de gancho

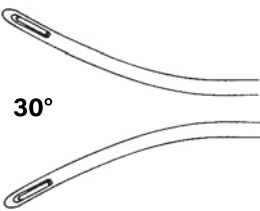
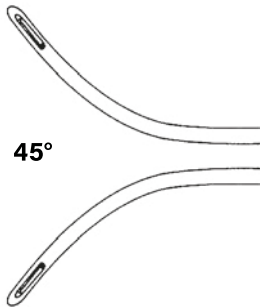

		3,4 mm Ø	2,8 mm Ø
	Hakenschere Hook scissors Tijera en forma de gancho		
	gerade / straight / recta	<b>R450-034130-000</b>	<b>R450-028130-000</b>
	Schaft gebogen / shaft curved vaina curva:		
30°	rechts / right / derecha	<b>R450-034130-030</b>	<b>R450-028130-030</b>
	links / left / izquierda	<b>R450-034130-130</b>	<b>R450-028130-130</b>
			
45°	rechts / right / derecha	<b>R450-034130-045</b>	<b>R450-028130-045</b>
	links / left / izquierda	<b>R450-034130-145</b>	<b>R450-028130-145</b>
	Maulteil gewinkelt / jaw angled boca angulada:		
45°	rechts / right / derecha	<b>R450-034130-245</b>	
	links / left / izquierda	<b>R450-034130-345</b>	

Schere gezahnt  
Scissors serrated  
Tijera dentada

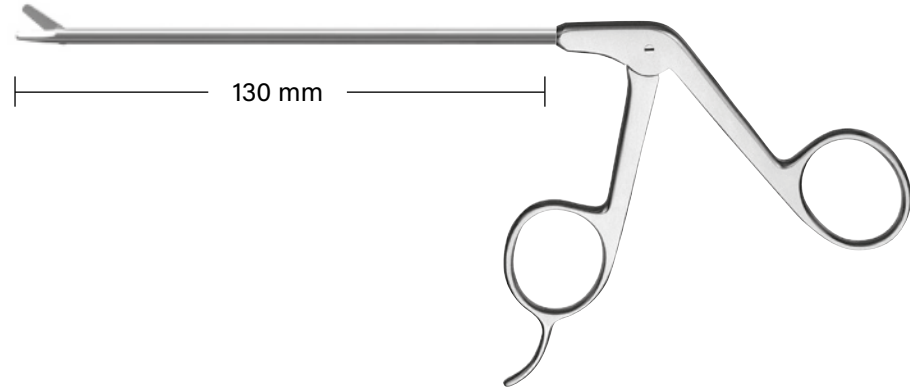

3,4 mm Ø



Schere gezahnt  
Scissors serrated  
Tijera dentada  
gerade / straight / recta

**R451-034130-000**

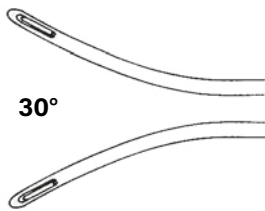

30°

Schaft gebogen / shaft curved  
vaina curva:  
rechts / right / derecha  
links / left / izquierda

**R451-034130-030**

**R451-034130-130**

45°

rechts / right / derecha  
links / left / izquierda

**R451-034130-045**

**R451-034130-145**

Faßzangen  
Grasper  
Pinzas de agarre

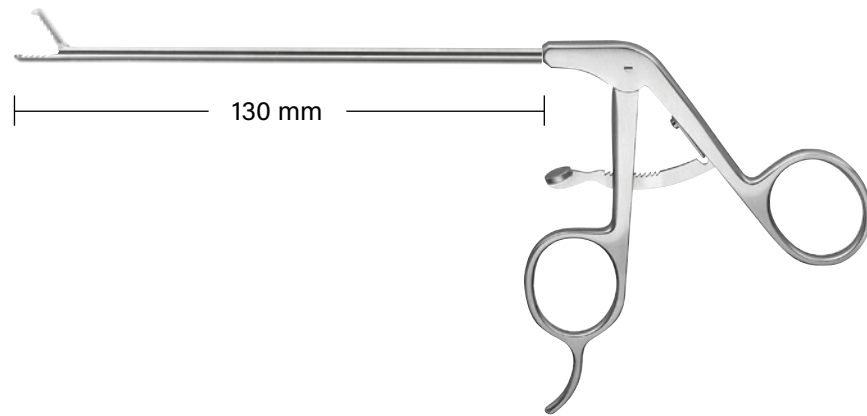

Greifzange  
Alligator grasping Forceps  
Pinza de agarre

3,4 mm Ø **R430-034130-000**  
2,8 mm Ø **R430-028130-000**

Greifzange mit Sperre  
Alligator grasping forceps, with ratchet  
Pinza de agarre con cremallera

3,4 mm Ø **R431-034130-000**  
2,8 mm Ø **R431-028130-000**



Faßzange mit Mauszahn  
Alligator grasping forceps with mouse teeth  
Pinza de agarre con diente de ratón

3,4 mm Ø **R432-034130-000**  
2,8 mm Ø **R432-028130-000**

Faßzange, Mauszahn und Sperre  
Alligator grasping forceps with mouse teeth and ratchet  
Pinza de agarre con diente de ratón y cremallera

3,4 mm Ø **R433-034130-000**  
2,8 mm Ø **R433-028130-000**



Faß-Biopsie-Zange  
Grasping and biopsy forceps  
Pinza de agarre y biopsia

3,4 mm Ø **R434-034130-000**  
2,8 mm Ø **R434-028130-000**

Faß-Biopsie-Zange mit Sperre  
Grasping and biopsy forceps with ratchet  
Pinza de agarre y biopsia con cremallera

3,4 mm Ø **R435-034130-000**  
2,8 mm Ø **R435-028130-000**

Biopsie-Zange  
Biopsy forceps  
Pinza de biopsia

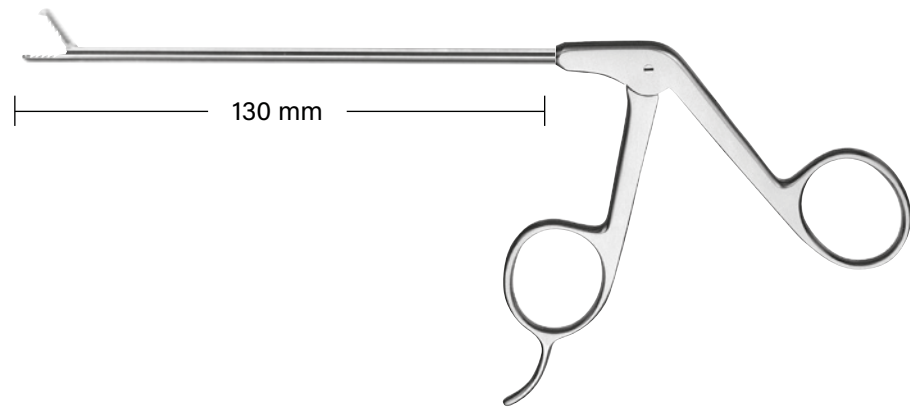

Biopsiezange  
Biopsy forceps  
Pinza de biopsia

3,4 mm Ø **R436-034130-000**  
2,8 mm Ø **R436-028130-000**



Biopsiezange, mit Dorn  
Biopsy forceps, with spike  
Pinza de biopsia, con espina

3,4 mm Ø **R436-034130-001**  
2,8 mm Ø **R436-028130-001**

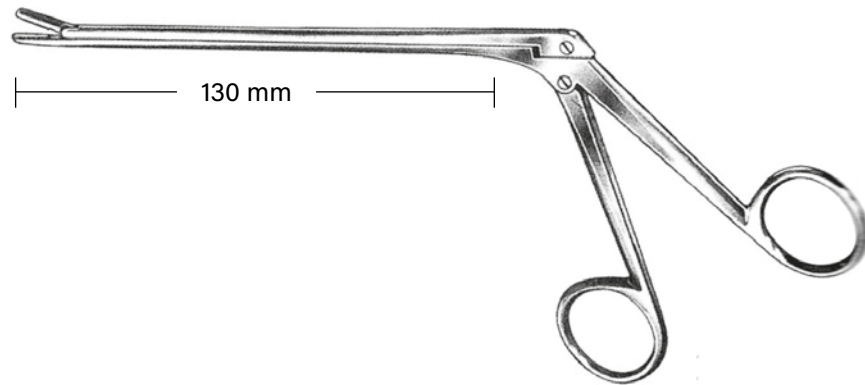

Meniskus-Faßzange kräftig  
Meniscus grasping forceps, strong  
Pinza de agarre para el menisco, fuerte

2 x 10 mm	<b>R436-042150-210</b>
3 x 10 mm	<b>R436-042150-310</b>
4 x 10 mm	<b>R436-042150-410</b>

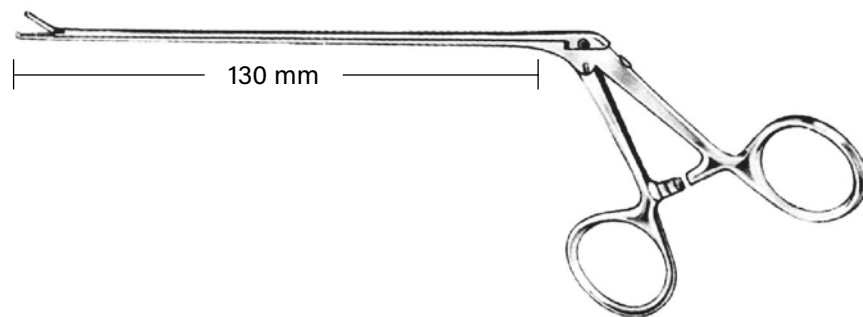

Mini-Faß-Zange mit Mauszahn und Sperre, 2,2 mm Ø  
Mini grasper with mouse teeth and ratchet, 2.2 mm Ø  
Pinza de agarre, modelo mini, con diente de ratón y cremallera, 2,2 mm Ø

**R437-022130-000**

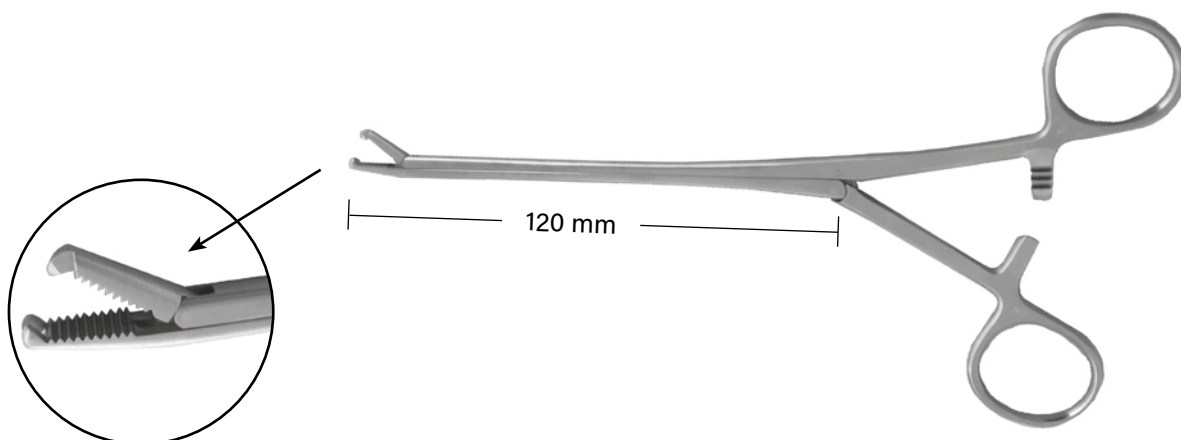

Meniskusretraktor gerade mit Mauszahn und Sperre  
Meniscus retractor straight with mouse teeth and ratchet  
Retractor de menisco, recto, con diente de ratón y cremallera

**R438-035130-000**

Fadenzangen, ø 3,4 mm  
 Ligature forceps, ø 3,4 mm  
 Pinzas para ligadura, ø 3,4 mm

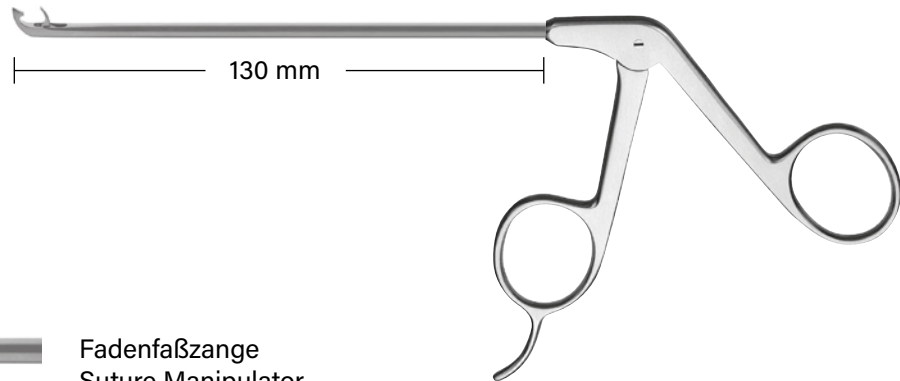

Fadenfaßzange  
 Suture Manipulator  
 pinza de agarre para sutura



gerade / straight / recta  
 aufwärts / upwards  
 hacia arriba

**R439-034130-000**

**R439-034130-015**

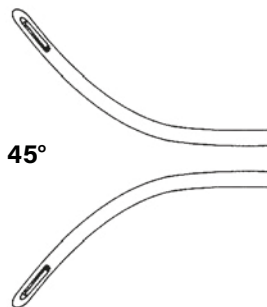

rechts / right / derecha  
 links / left / izquierda

**R439-034130-045**

**R439-034130-145**



Fadenfänger gerade  
 Suture grasper  
 pinza de agarre recta

**R439-034130-100**



aufwärts / upwards  
 hacia arriba

**R439-034130-115**



Faden Punch gerade  
 Suture punch straight  
 pinza de agarre recta

**R439-034130-200**



45° aufwärts / upwards  
 45° hacia arriba

**R439-034130-300**



10° aufwärts / upwards  
 10° hacia arriba

**R439-034130-310**



Instrumente für 2. Einstich  
 Instruments for 2<sup>nd</sup> puncture  
 Instrumentos para la segunda perforación

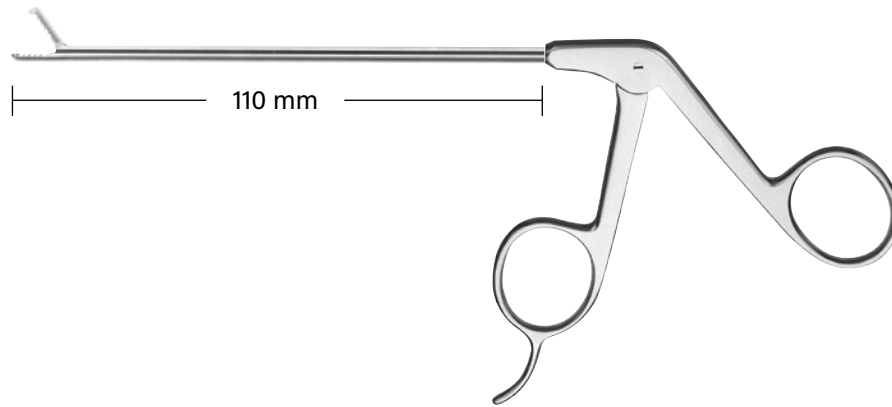

Zange mit Doppellöfel, 2 mm Ø  
 Forceps with double spoon, 2 mm Ø  
 Pinza con cucharilla doble, 2 mm Ø

**R480-020110-000**



Zange durchschneidend, 2 mm Ø  
 Forceps cutting through, 2 mm Ø  
 Pinza cortante, 2 mm Ø

**R481-020110-000**



Schere, 2 mm Ø  
 Scissors, 2 mm Ø  
 Tijera, 2 mm Ø

**R485-020110-000**



Faß-Biopsie-Zange, 2 mm Ø  
 Grasping and biopsy forceps, 2 mm Ø  
 Pinza de agarre y biopsia, 2 mm Ø

**R486-020110-000**



Greif-Zange, 2 mm Ø  
 Grasping Forceps, 2 mm Ø  
 Pinza de agarre, 2 mm Ø

**R487-020110-000**

Hand-Instrumente  
Hand instruments  
Instrumentos manuales



Hakensonde graduiert  
Hook probe graduated  
Gancho explorador graduado  
3 mm  
5 mm

**R490-030110-03**  
**R490-030110-05**



Skalpellmesser  
Scalpel knife  
Cuchillo de bisturí

**R490-030110-11**



Hakenmesser  
Hook knife  
Cuchillo en forma de gancho

**R490-030110-12**



Messer retrograd  
Knife, retrograde  
Cuchillo retrógrado

**R490-030110-13**

Banana-Messer  
Banana knife  
Cuchillo en forma de plátano



glatt / smooth / liso

**R490-030110-14**



gezahnt / serrated / dentado

**R490-030110-15**



Rosettenmesser  
Rosette knife  
Cuchillo en forma de roseta

**R490-030110-16**



Meniskotom nach Smillie  
Smillie knife  
Meniscótomo de Smillie

3 mm  
5 mm  
7 mm

**R490-030110-43**  
**R490-030110-45**  
**R490-030110-47**



Messer sichelförmig  
Sickle knife  
Cuchillo en forma de hoz

**R490-030110-17**



Löffel, 3 mm Ø  
Spoon, 3 mm Ø  
Cucharilla, 3 mm Ø

**R490-030110-21**



Ring-Kürette  
Ring curette  
Cureta en forma de anillo

3 mm Ø  
5 mm Ø  
7 mm Ø

**R490-030110-31**  
**R490-030110-32**  
**R490-030110-33**



Knorpelfeile, fein  
Cartilage file, fine  
Lima para cartilago, fina

**R490-030110-51**









Knorpelfeile, grob  
Cartilage file, coarse  
Lima para cartilago, gruesa

**R490-030110-52**

Hand-Instrumente, zweiteilig  
 Hand instruments, two parts  
 Instrumentos manuales, de dos partes



	Hakensonde graduiert Hook probe graduated Gancho explorador graduado	
	2,5 mm	<b>R492-030110-03</b>
	3,5 mm	<b>R492-030110-04</b>
	Hakensonde spitz Palpation hook pointed Gancho explorador agudo	<b>R492-030110-00</b>
	Skalpellmesser Scalpel knife Cuchillo de bisturí	<b>R492-030110-11</b>
	Hakenmesser Hook knife Cuchillo en forma de gancho	<b>R492-030110-12</b>
	Messer retrograd Knife retrograde Cuchillo retrógrado	<b>R492-030110-13</b>
	Banana-Messer Banana knife Cuchillo en forma de plátano	
	glatt / smooth / liso	<b>R492-030110-14</b>
	gezahnt / serrated / dentado	<b>R492-030110-15</b>
	Rosettenmesser Rosette knife Cuchillo en forma de roseta	<b>R492-030110-16</b>

Hand-Instrumente, zweiteilig  
Hand instruments, two parts  
Instrumentos manuales, de dos partes



Griff allein mit Spannzange  
Handle alone with wrench  
Mango solo con adaptador de fijación

**R492-000000-000**



Meniskotom nach Smillie  
Smillie knife  
Meniscótomo de Smillie

3 mm  
5 mm  
7 mm

**R492-030110-43**  
**R492-030110-45**  
**R492-030110-47**



Messer sichelförmig  
Sickle knife  
Cuchillo en forma de hoz

**R492-030110-17**



Löffel, 3 mm Ø  
Spoon, 3 mm Ø  
Cucharilla, 3 mm Ø

**R492-030110-21**



Ring-Kürette, 3 mm Ø  
Ring curette, 3 mm Ø  
Cureta en forma de anillo, 3 mm Ø

**R492-030110-31**



Ring-Kürette, 7 mm Ø  
Ring curette, 7 mm Ø  
Cureta en forma de anillo, 7 mm Ø

**R492-030110-32**



Knorpelfeile, fein  
Cartilage file, fine  
Lima para cartilago, fina

**R492-030110-51**



Knorpelfeile, grob  
Cartilage file, coarse  
Lima para cartilago, gruesa

**R492-030110-52**

Hand-Instrumente  
Hand instruments  
Instrumentos manuales



Meniskotom nach Smillie  
Smillie meniscotome  
Meniscótomo de Smillie

3 mm  
5 mm

**R494-030110-43**  
**R494-030110-45**



Messer sichelförmig  
Sickel knife  
Cuchillo en forma de hoz

**R494-030110-17**



Löffel, 3 mm Ø  
Spoon 3 mm Ø  
Cucharilla, 3 mm Ø

**R494-030110-21**



Ring-Kürette, 3 mm Ø  
Ring curette, 3 mm Ø  
Cureta en forma de anillo, 3 mm Ø

**R494-030110-31**



Hakensonde  
Hook probe  
Gancho explorador

3,5 mm graduiert / graduated / graduado  
4 mm

**R494-030110-03**  
**R494-030110-04**



Skalpellmesser  
Scalpel knife  
Cuchillo de bisturí

**R494-030110-11**



Hakenmesser  
Hook knife  
Cuchillo en forma de gancho

**R494-030110-12**



Messer retrograd  
Knife, retrograde  
Cuchillo retrógrado

**R494-030110-13**

Banana-Messer  
Banana knife  
Cuchillo en forma de plátano



glatt / smooth / liso

**R494-030110-14**



gezahnt / serrated / dentado

**R494-030110-15**



Rosettenmesser  
Rosette knife  
Cuchillo en forma de roseta

**R494-030110-16**



Knorpelfeile, fein  
Cartilage file, fine  
Lima para cartilago, fina

**R494-030110-51**



Knorpelfeile, grob  
Cartilage file, coarse  
Lima para cartilago, gruesa

**R494-030110-52**

Inflow-Kanüle  
Inflow cannula  
Cánula Inflow



Spülkanüle mit 2 seitlichen Löchern, LL-Anschluß, 4,5 mm Ø, 8,3 cm  
Irrigation cannula with 2 holes, LL-connection, 4.5 mm Ø, 8.3 cm  
Canula de irrigación con dos perforaciones laterales, conexión LL, 4,5 mm Ø, 8,3 cm

**R470-045083-000**



scharfer Obturator  
sharp obturator  
obturador agudo

**R470-045083-001**



stumpfer Obturator  
blunt obturator  
obturador romo

**R470-045083-002**



Spüladapter mit Schlauchlive  
Irrigation adapter with tube connection  
Adaptador con conexión al tubo

**R470-045000-000**



Spülkanüle  
Irrigation cannula  
Cánula de irrigación

Spülsatz, komplett mit Kanüle und Obturatoren  
Aspiration cannula complete with cannula and obturators  
Cánula de irrigación completa con canula e obturadores

3,2 mm Ø

4,5 mm Ø

**R471-032070-199**

**R471-045070-199**

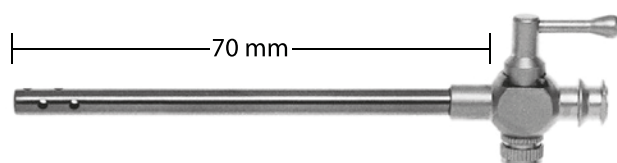

Kanüle für Spülung mit Hahn, LL-Anschluß, 7 cm lang  
Cannula for irrigation with stop cock LL-connection, 7 cm length  
Cánula de irrigación con llave, conexión LL, largo útil de 7 cm

**R471-032070-000**

**R471-045070-000**

scharfer Obturator  
sharp obturator  
obturador agudo



**R471-032070-024**

**R471-045070-024**

stumpfer Obturator  
blunt obturator  
obturador romo



**R471-032070-003**

**R471-045070-003**

Kanüle für Spülung, LL-Anschluß, 3,2 mm Ø, 7 cm lang  
Cannula for irrigation, LL-connection, 3,2 mm Ø, 7 cm length  
Cánula de irrigación, conexión LL, 3,2 mm Ø, largo útil de 7 cm



**R472-032070-000**

Endoskope für Arthroskopie  
Endoscopes for Arthroscopy  
Endoscopios para artroscopía

## Ø 1,9 mm

Arthroskop, autoklavierbar mit integrierter Faser zur Beleuchtung für diagnostische und operative Eingriffe:  
kleine Gelenke

Arthroscope, autoclavable, with integrated fiber optic for illumination, for diagnostic and operation:  
small joint

Artroscopios (ópticas) autoclavables con fibroptica incorporado para intervenciones diagnósticas y operativas:  
articulaciones pequeñas

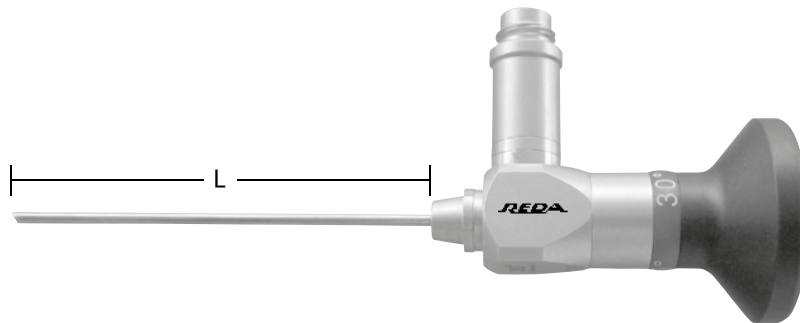

69 mm

102 mm

**R400-019069-030**

**R400-019102-030**

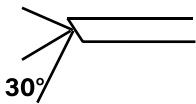

Vorausblick  
Foroblique vision  
ángulo de

Instrumente für 2. Einstich  
Instruments for 2<sup>nd</sup> puncture  
Instrumentos para la segunda perforación

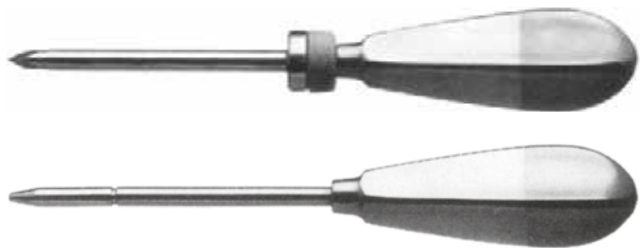

Trokarhülse mit scharfem und stumpfem Obturator, 2,5 mm Ø  
Trocar sleeve with sharp and blunt obturator, 2.5 mm Ø  
Tubo con obturadores agudos y romos, 2,5 mm Ø

**R490-025110-43**

Endoskop Ersatzteile und Zubehör  
Endoscope Spare Parts and Accessories  
Piezas de repuesto y Accesorios para Artroscofía

Farbcode für Blickrichtung:  
Colour coding for indication of direction of view:  
Indicación a color para definir la dirección de la vista:

grün / green / verde	= 0°
rot / red / rojo	= 30°
orange / orange / naranja	= 45°
gelb / yellow / amarillo	= 70°

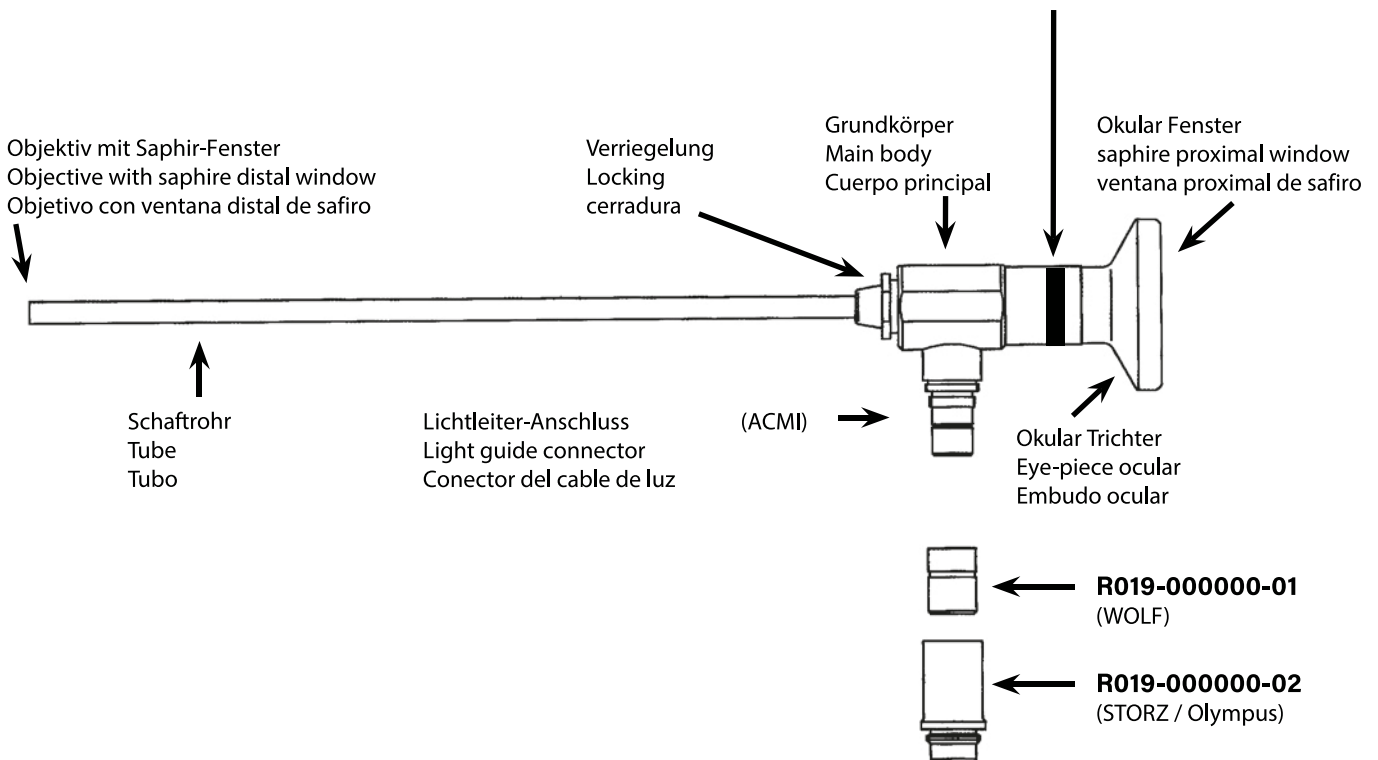

Scope Pak klein für Arthroskop  
Scope pak small for one Arthroscope  
Caja pequeña para Artroscofio

**R019-9312**

Zubehör  
Accessories  
Accesorios



Antibeslagmittel Ultra Stop 25 ml unsteril in Pipettenflasche  
Anti Fog liquid Ultra Stop 25 ml non sterile  
Agente antivano ultra stop 25 ml, no esteril en frasco de pipeta

**R019-000000-025**

Antibeslagmittel Ultra Stop steril 30 ml in Einstichflasche  
Anti Fog liquid Ultra Stop sterile incision bottle 30 ml  
Agente antivano ultra stop, esteril 30 ml en frasco de pinchazo

**R019-000000-030**



Reinigungsmittel, Tube mit 6gr. f. distale u. proximale Linsen u. Fiberglas-Flächen von Endoskopen  
Cleaning waste, 6gr. f. distal and proximal windows and fiber optic port of endoscopes  
Agente de limpieza, tubo con 6gr para ventanas y optical distales y proximales

**98002-06**

**Container Typen und Dimensionen**  
**Container models and dimensions**  
**Modelos de contenedores y medidas**

285 x 280 x 200 mm



Deckel gelocht  
 Boden ungelocht  
 Perforated lid  
 Unperforated bottom  
 Tapa perforada  
 Cuerpo sin perforación



Deckel gelocht  
 Boden gelocht  
 Perforated lid  
 Perforated bottom  
 Tapa perforada  
 Cuerpo perforado



Sicherheitsdeckel  
 Boden ungelocht  
 Safety lid  
 Unperforated bottom  
 Tapa de seguridad  
 Cuerpo sin perforación



Sicherheitsdeckel  
 Boden gelocht  
 Safety lid  
 Perforated bottom  
 Tapa de seguridad  
 Cuerpo perforado



silber  
 gelb  
 rot  
 blau  
 grün

R 310.20
R 320.20
R 330.20
R 340.20
R 350.20

R 311.20
R 321.20
R 331.20
R 341.20
R 351.20

R 312.20
R 322.20
R 332.20
R 342.20
R 352.20

R 313.20
R 323.20
R 333.20
R 343.20
R 353.20

**Lagerungs- und Sterilisierack**  
**Storage- and sterilization rack**  
**Soportos para almacenaje y esterilización**

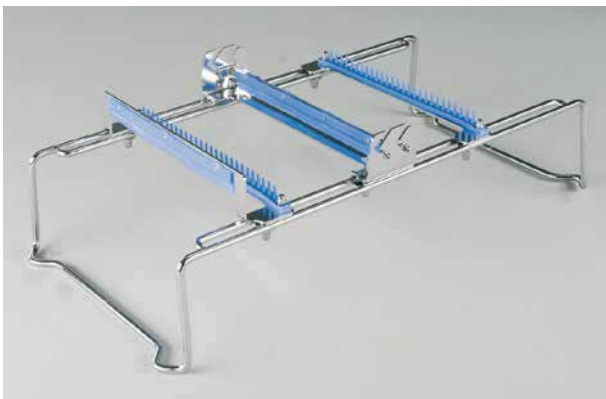

**89258-25**  
 232 x 210 x 155 mm

für Arthroskopie Instrumente  
 for arthroscopy instruments  
 para instrumentos de artroscopia



## Arthroscopic Shaver

- High quality arthroscopic shaver system
- Controlled by a wireless or cable footswitch.
- Efficient, light and ergonomic handpiece enhanced by a wide range of rotational speed.
- Designed to work with multi- and single-use shaver blades.

### Features

- Outputs for two handpieces
- A handpiece with automatic or manual lock
- Clockwise, counterclockwise and oscillation handpiece rotation modes
- Three oscillation modes: light, medium and aggressive
- Controlled by a control unit panel or footswitch
- Automatic identification of a connected handpiece and set of previously used parameters
- Working with various shaver blades of well-known manufacturers

### Benefits

- Wireless footswitch
- Ergonomic and autoclavable handpiece
- Protection against overloading of a handpiece
- Smooth and continuous work of the motor.
- Stable oscillation mode
- Fully controlled rotational and oscillation speed
- Disposable and multi-use shaver blades (with no use-limits)
- Non-volatile memory of recent settings
- Big and clear display
- Esthetic and modern design
- Multi-language menu (English, German, French, Polish, Russian and Turkish)

# Technical parameters

## SHAVER CONSOLE

RED-8002-10	Technical Data
Input voltage	100-240V AC
Frequency voltage	50/60Hz
External dimensions	D: 306 mm x W: 330 mm x H: 96 mm
Weight	5,1 kg
Ambient temperature	During operation: +10°C to +40°C During storage and transport: -20°C to +45°C
Max. relative humidity	During operation: 70% During storage and transport: 70%
Class of protection	Applied part - type B
CE Standard	EN60601-1; EN60601-1-2



## HANDPIECE

RED-8008-11H	Technical Data
Length	185 mm / 188 mm
Weight	400 g / 410 g
Blades chuck	Manual locking
Speed range	800 - 8000 RPM (± 10%)
Oscillate cycle	Light (0,5 sec.), Medium (0,3 sec.), Aggressive (0,2 sec.)
Cable length	3m
Sterilization method	Steam sterilization 134°C
Ambient temperature	During operation: +10°C to +40°C During storage and transport: -20°C to +45°C
Max. relative humidity	During operation: 100% During storage and transport: 90%



## FOOTSWITCHES

Cable	RED-8005-2F
Wireless	RED-8005B-3F
Technical Data	
Dimensions	D: 215 mm x W: 280 mm x H: 28 mm
Weight	2,45 kg / 2,2 kg
Cable length	3 m / Wireless (up to receiver)
Battery type	N/A / Lithium-polymer accumulator
Nominal battery charge	N/A / 1250 mAh
Charger	N/A / 5 V DC / 700 mA
Battery lifetime	N/A / > 300 charging cycles
Casing safety standard	IP X8
Ambient temperature	During operation: +10°C to +40°C During storage and transport: -20°C to +45°C
Max. relative humidity	During operation: 100% During storage and transport: 90%



Mindestabnahme: 5 Stück  
Minimum purchase: 5 pieces  
Cantidad mínima: 5 unidades

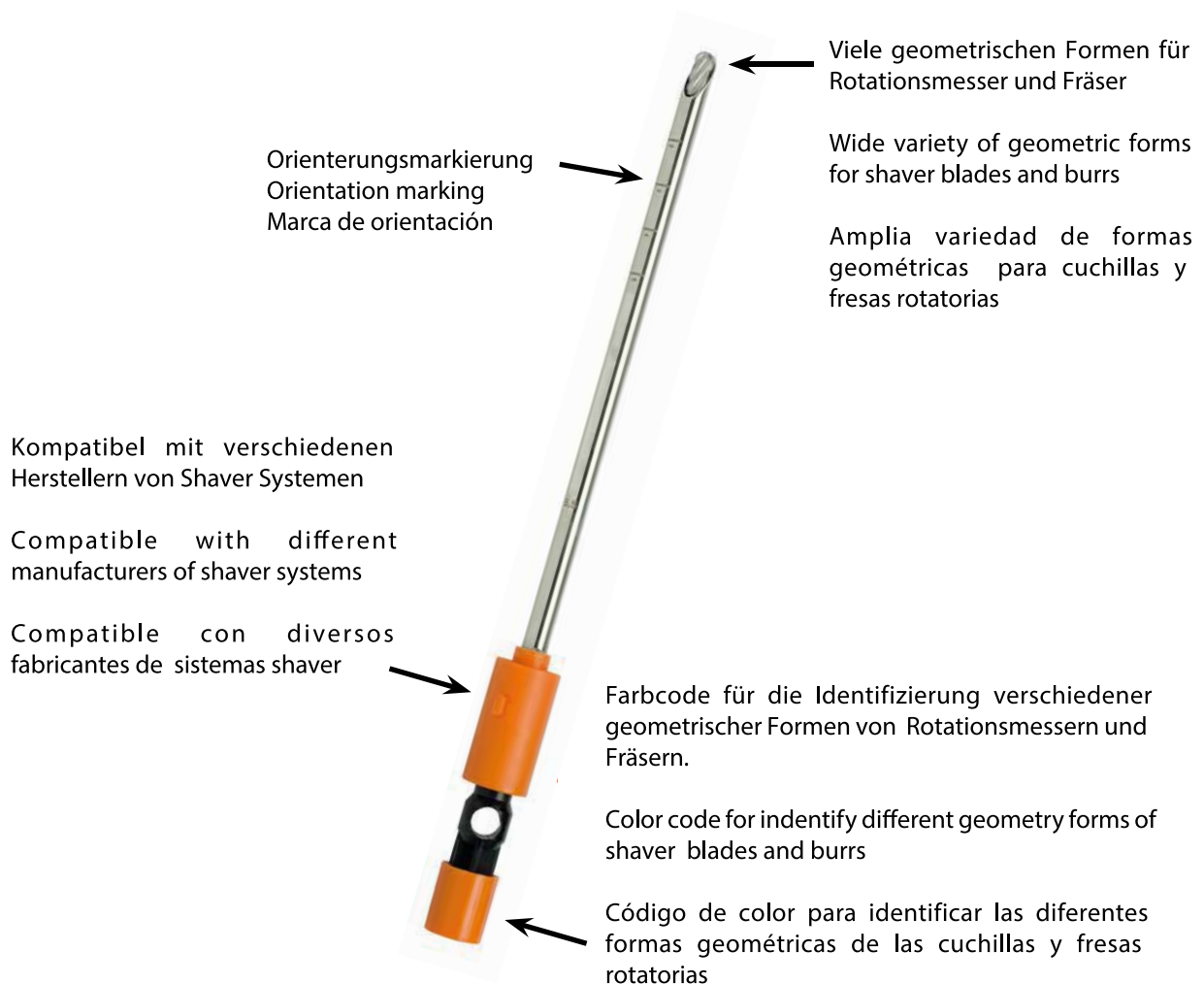

Hinweis: die Markierung ist hilfreich für die Orientierung, nicht zum Messen.  
Note: the marking is useful for orientation, not for measure.  
Nota: el marcado solo es útil para orientación, no para medir.

Auf Anfrage auch lieferbar in single use, steril  
on request available in single use, steril  
a petición disponible en desechable y esteril



## Shaver blades for Reda, Linvatec, Concept, Arthrex, Atlantec



Länge 130 mm, autoklavierbar, wiederverwendbar  
 Length 130 mm, autoclavable, reusable  
 Largo 130 mm, autoclavable, reusable

	Beschreibung Description Descripción	Ø 3,4 mm	Ø 4,2 mm	Ø 5,5 mm	
	Aggressive Full-Radius Resector	<b>R452-034130-001</b>	<b>R452-042130-001</b>	<b>R452-055130-001</b>	● ●
	Double Aggressive Full-Radius		<b>R452-042130-002</b>	<b>R452-055130-002</b>	○ ●
	Meniscus Cutter	<b>R452-034130-003</b>	<b>R452-042130-003</b>	<b>R452-055130-003</b>	● ●
	End Cutter		<b>R452-042130-004</b>	<b>R452-055130-004</b>	○ ●
	Full-Radius Resector	<b>R452-034130-005</b>	<b>R452-042130-005</b>	<b>R452-055130-005</b>	○ ○
	Incisor	<b>R452-034130-006</b>	<b>R452-042130-006</b>	<b>R452-055130-006</b>	● ●
	Cutter		<b>R452-042130-007</b>		● ○
	Round Burr		<b>R452-042130-008</b>	<b>R452-055130-008</b>	● ●
	Tapered Burr			<b>R452-055130-009</b>	● ●
	Oval Burr		<b>R452-042130-010</b>	<b>R452-055130-010</b>	● ●

<b>89</b>	
89258-25	45

<b>98</b>	
98002-06	44

<b>R</b>	
R 310.20	45
R 311.20	45
R 312.20	45
R 313.20	45
R 320.20	45
R 321.20	45
R 322.20	45
R 323.20	45
R 330.20	45
R 331.20	45
R 332.20	45
R 333.20	45
R 340.20	45
R 341.20	45
R 342.20	45
R 343.20	45
R 350.20	45
R 351.20	45
R 352.20	45
R 353.20	45

<b>R019</b>	
R019-000000-01	43
R019-000000-02	43
R019-000000-025	44
R019-000000-030	44
R019-9312	43

<b>R400</b>	
R400-019069-030	42
R400-019102-030	42
R400-027110-000	6
R400-027110-030	6
R400-027175-000	8
R400-027175-030	8
R400-027175-070	8
R400-027188-000	10
R400-027188-030	10
R400-027188-070	10
R400-040175-000	4
R400-040175-030	4
R400-040175-045	4
R400-040175-070	4

R410-027110-001	7
R410-027110-002	7
R410-027110-003	7
R410-027175-001	9
R410-027175-002	9
R410-027175-003	9
R410-027188-001	11
R410-027188-002	11
R410-027188-003	11
R410-040175-001	5
R410-040175-002	5

R410-040175-003	5
-----------------	---

<b>R413</b>	
R413-027110-030	7
R413-027110-070	7
R413-027175-030	9
R413-027175-070	9
R413-027188-030	11
R413-027188-070	11
R413-040175-030	5
R413-040175-070	5

<b>R414</b>	
R414-027110-030	7
R414-027110-070	7
R414-027175-030	9
R414-027175-070	9
R414-027188-030	11
R414-027188-070	11
R414-040175-030	5
R414-040175-070	5

<b>R430</b>	
R430-028130-000	29
R430-034130-000	29

<b>R431</b>	
R431-028130-000	29
R431-034130-000	29

<b>R432</b>	
R432-028130-000	29
R432-034130-000	29

<b>R433</b>	
R433-028130-000	29
R433-034130-000	29

<b>R434</b>	
R434-028130-000	29
R434-034130-000	29

<b>R435</b>	
R435-028130-000	29
R435-034130-000	29

<b>R436</b>	
R436-028130-000	30
R436-028130-001	30
R436-034130-000	30
R436-034130-001	30
R436-042150-210	31
R436-042150-310	31
R436-042150-410	31

<b>R437</b>	
R437-022130-000	31

<b>R438</b>	
R438-035130-000	31

<b>R439</b>	
R439-034130-000	32
R439-034130-015	32
R439-034130-045	32
R439-034130-100	32
R439-034130-115	32
R439-034130-145	32
R439-034130-200	32
R439-034130-300	32
R439-034130-310	32

<b>R440</b>	
R440-028130-000	12
R440-028130-007	12
R440-028130-015	12
R440-028130-030	12
R440-028130-045	12
R440-028130-107	12
R440-028130-115	12
R440-028130-130	12
R440-028130-145	12
R440-028130-200	13
R440-028130-207	13
R440-028130-215	13
R440-028130-230	13
R440-028130-245	13
R440-028130-307	13
R440-028130-315	13
R440-028130-330	13
R440-028130-345	13
R440-034130-000	12
R440-034130-007	12
R440-034130-015	12
R440-034130-030	12
R440-034130-045	12
R440-034130-107	12
R440-034130-115	12
R440-034130-130	12
R440-034130-145	12
R440-034130-200	13
R440-034130-207	13
R440-034130-215	13
R440-034130-230	13
R440-034130-245	13
R440-034130-307	13
R440-034130-315	13
R440-034130-330	13
R440-034130-345	13
R440-034130-590	24

<b>R441</b>	
R441-028130-000	14
R441-028130-007	14
R441-028130-015	14
R441-028130-030	14
R441-028130-045	14
R441-028130-107	14
R441-028130-115	14
R441-028130-130	14
R441-028130-145	14

R441-028130-200	17
R441-028130-207	17
R441-028130-215	17
R441-028130-230	17
R441-028130-245	17
R441-028130-307	17
R441-028130-315	17
R441-028130-330	17
R441-028130-345	17
R441-028130-400	15
R441-028130-407	15
R441-028130-415	15
R441-028130-430	15
R441-028130-445	15
R441-028130-607	15
R441-028130-615	15
R441-028130-630	15
R441-028130-645	15
R441-034130-000	14
R441-034130-007	14
R441-034130-015	14
R441-034130-030	14
R441-034130-045	14
R441-034130-107	14
R441-034130-115	14
R441-034130-130	14
R441-034130-145	14
R441-034130-200	17
R441-034130-207	17
R441-034130-215	17
R441-034130-230	17
R441-034130-245	17
R441-034130-307	17
R441-034130-315	17
R441-034130-330	17
R441-034130-345	17
R441-034130-400	15
R441-034130-407	15
R441-034130-415	15
R441-034130-430	15
R441-034130-445	15
R441-034130-545	24
R441-034130-590	24
R441-034130-607	15
R441-034130-615	15
R441-034130-630	15
R441-034130-645	15
R441-034130-745	24
R441-034130-790	24

<b>R442</b>	
R442-028130-000	16
R442-028130-007	16
R442-028130-015	16
R442-028130-030	16
R442-028130-045	16
R442-028130-107	16
R442-028130-115	16
R442-028130-130	16
R442-028130-145	16
R442-034130-000	16
R442-034130-007	16
R442-034130-015	16
R442-034130-030	16

R442-034130-045	16
R442-034130-107	16
R442-034130-115	16
R442-034130-130	16
R442-034130-145	16

#### R443

R443-034130-000	19
R443-034130-007	19
R443-034130-015	19
R443-034130-030	19
R443-034130-045	19
R443-034130-107	19
R443-034130-115	19
R443-034130-130	19
R443-034130-145	19
R443-034130-200	19
R443-034130-207	19
R443-034130-215	19
R443-034130-230	19
R443-034130-245	19
R443-034130-307	19
R443-034130-315	19
R443-034130-330	19
R443-034130-345	19
R443-034130-507	25
R443-034130-515	25
R443-034130-530	25
R443-034130-545	25
R443-034130-590	25
R443-034130-607	25
R443-034130-615	25
R443-034130-630	25
R443-034130-645	25
R443-034130-707	25
R443-034130-715	25
R443-034130-730	25
R443-034130-745	25
R443-034130-790	25
R443-034130-807	25
R443-034130-815	25
R443-034130-830	25
R443-034130-845	25

#### R444

R444-034130-000	18
R444-034130-007	18
R444-034130-015	18
R444-034130-030	18
R444-034130-045	18
R444-034130-107	18
R444-034130-115	18
R444-034130-130	18
R444-034130-145	18
R444-034130-200	18
R444-034130-207	18
R444-034130-215	18
R444-034130-230	18
R444-034130-245	18
R444-034130-307	18
R444-034130-315	18
R444-034130-330	18
R444-034130-445	23

#### R446

R446-034130-000	20
R446-034130-007	20
R446-034130-015	20
R446-034130-030	20
R446-034130-045	20
R446-034130-107	20
R446-034130-115	20
R446-034130-130	20
R446-034130-145	20
R446-034130-200	20
R446-034130-207	20
R446-034130-215	20
R446-034130-230	20
R446-034130-245	20
R446-034130-307	20
R446-034130-315	20
R446-034130-330	20
R446-034130-345	20

#### R447

R447-034130-000	21
R447-034130-007	21
R447-034130-015	21
R447-034130-030	21
R447-034130-045	21
R447-034130-107	21
R447-034130-115	21
R447-034130-130	21
R447-034130-145	21

#### R448

R448-034130-000	22
R448-034130-015	22
R448-034130-045	22
R448-034130-145	22
R448-034130-200	22
R448-035130-600	23
R448-035130-800	23

#### R449

R449-035100-090	26
R449-035100-190	26

#### R450

R450-028130-000	27
R450-028130-030	27
R450-028130-045	27
R450-028130-130	27
R450-028130-145	27
R450-034130-000	27
R450-034130-030	27
R450-034130-045	27
R450-034130-130	27
R450-034130-145	27
R450-034130-245	27
R450-034130-345	27

#### R451

R451-034130-000	28
R451-034130-030	28
R451-034130-045	28
R451-034130-130	28

R451-034130-145	28
-----------------	----

#### R452

R452-034130-001	49
R452-034130-003	49
R452-034130-005	49
R452-034130-006	49
R452-042130-001	49
R452-042130-002	49
R452-042130-003	49
R452-042130-004	49
R452-042130-005	49
R452-042130-006	49
R452-042130-007	49
R452-042130-008	49
R452-042130-010	49
R452-055130-001	49
R452-055130-002	49
R452-055130-003	49
R452-055130-004	49
R452-055130-005	49
R452-055130-006	49
R452-055130-008	49
R452-055130-009	49
R452-055130-010	49

#### R470

R470-045000-000	40
R470-045083-000	40
R470-045083-001	40
R470-045083-002	40

#### R471

R471-032070-000	41
R471-032070-003	41
R471-032070-024	41
R471-032070-199	41
R471-045070-000	41
R471-045070-003	41
R471-045070-024	41
R471-045070-199	41

#### R472

R472-032070-000	41
-----------------	----

#### R480

R480-020110-000	33
-----------------	----

#### R481

R481-020110-000	33
-----------------	----

#### R485

R485-020110-000	33
-----------------	----

#### R486

R486-020110-000	33
-----------------	----

#### R487

R487-020110-000	33
-----------------	----

#### R490

R490-025110-43	42
----------------	----

R490-030110-03	34
R490-030110-05	34
R490-030110-11	34
R490-030110-12	34
R490-030110-13	34
R490-030110-14	34
R490-030110-15	34
R490-030110-16	34
R490-030110-17	35
R490-030110-21	35
R490-030110-31	35
R490-030110-32	35
R490-030110-33	35
R490-030110-43	35
R490-030110-45	35
R490-030110-47	35
R490-030110-51	35
R490-030110-52	35

#### R492

R492-000000-000	37
R492-030110-00	36
R492-030110-03	36
R492-030110-04	36
R492-030110-11	36
R492-030110-12	36
R492-030110-13	36
R492-030110-14	36
R492-030110-15	36
R492-030110-16	36
R492-030110-17	37
R492-030110-21	37
R492-030110-31	37
R492-030110-32	37
R492-030110-43	37
R492-030110-45	37
R492-030110-47	37
R492-030110-51	37
R492-030110-52	37

#### R494

R494-030110-03	39
R494-030110-04	39
R494-030110-11	39
R494-030110-12	39
R494-030110-13	39
R494-030110-14	39
R494-030110-15	39
R494-030110-16	39
R494-030110-17	38
R494-030110-21	38
R494-030110-31	38
R494-030110-43	38
R494-030110-45	38
R494-030110-51	39
R494-030110-52	39

#### RED-800

RED-8002-10	47
RED-8005-2F	47
RED-8005B-3F	47
RED-8008-11H	47

## Index Deutsch

### A

Antrumstanze .....	23
Adapter .....	40
Arthroskope.....	4, 6, 8, 10, 42
Arthroskopieschäfte.....	5, 7, 9, 11
Arthroskopie-Shaver.....	46

### B

Biopsiestanzen.....	24, 25, 30
---------------------	------------

### C

Container .....	45
-----------------	----

### E

Endoskope .....	4, 6, 8, 10, 42
-----------------	-----------------

### F

Fadenzangen .....	32
Faßzangen.....	29
Fußschalter.....	47

### H

Handstück .....	47
Hakenschere .....	27-28
Hakenstanzen.....	12-26
Handinstrumente.....	34-39

### I

Inflow Kanüle.....	40
Instrumente für 2. Einstich.....	33, 42

### L

Lagerungs- und Sterilisierack.....	45
------------------------------------	----

### M

Meniskusretraktor.....	31
------------------------	----

### O

Obturator.....	5, 7, 9, 11, 40-42
----------------	--------------------

### R

Rotationsmesser und Fräser.....	48-49
Rotationszange.....	26

### S

Schere .....	27-28, 33
Shaver-Konsole .....	67
Spülkanüle .....	41
Stanzen .....	12-26

### T

Trokarhülse .....	5, 7, 9, 11, 42
-------------------	-----------------

### Z

Zangen .....	30-32
Zubehör .....	44, 45

## Index English

### A

Accessories .....	44, 45
Adapter .....	40
Antrum Punch .....	23
Arthroscopes .....	4, 6, 8, 10, 42
Arthroscopic Shaver .....	46
Arthroscopy Sheath .....	5, 7, 9, 11

### B

Biopsy punch .....	24, 25, 30
--------------------	------------

### C

Container .....	45
-----------------	----

### E

Endoscopes .....	4, 6, 8, 10, 42
------------------	-----------------

### F

Footswitches.....	47
Forceps.....	30-32

### G

Grasper .....	29
---------------	----

### H

Hand Instruments.....	34-39
Handpiece .....	47
Hook Punches.....	12-26
Hook Scissors.....	27-28

### I

Inflow Cannula .....	40
Instruments for 2nd Puncture .....	33, 42
Irrigation Cannula.....	41

### L

Ligature Forceps .....	32
------------------------	----

### M

Meniscus retractor .....	31
--------------------------	----

### O

Obturator.....	5, 7, 9, 11, 40-42
----------------	--------------------

### P

Punches.....	12-26
--------------	-------

### R

Rotary Punches .....	26
----------------------	----

### S

Scissors .....	27-28, 33
Shaver Blades & Burrs.....	48-49
Shaver Console.....	46
Storage- and sterilization rack.....	45

### T

Trocar Sleeves.....	5, 7, 9, 11, 42
---------------------	-----------------

## Index Español

### A

Accesorios..... 44, 45  
Adaptador..... 40  
Artroscopios..... 4, 6, 8, 10, 42

### C

Canula de irrigacion .....41  
Canula Inflow ..... 40  
Contenedores.....45  
Consola Shaver.....47  
Cuchillas y fresas rotatorias..... 48-49

### E

Endoscopios..... 4, 6, 8, 10, 42

### I

Interruptores de pie .....47  
Instrumentos manuales..... 34-39  
Instrumentos para la  
segunda perforacion..... 33, 42

### M

Manga De Trocar ..... 5, 7, 9, 11, 42

### O

Obturadores .....5, 7, 9, 11, 40-42

### P

Perforadore.....12-26  
Pieza de mano.....47  
Pinza Antrum .....23  
Pinza cortante .....12-26  
Pinza de biopsia .....24, 25, 30  
Pinza rotatoria .....26  
Pinzas ..... 30-32  
Pinzas de agarre.....29  
Pinzas para ligadura.....32

### R

Retractor de menisco ..... 31  
Soporto para  
almacenaje y esterilizacion.....45

### S

Shaver artroscópica ..... 46

### T

Tijera en forma de gancho ..... 27-28  
Tijeras .....27-28, 33

### V

Vainas para artroscopia.....5, 7, 9, 11



Hauptkatalog Chirurgische Instrumente  
General catalog surgical instruments

Neurochirurgie  
Neuro surgery

Plastische Chirurgie  
Plastic surgery

HNO  
ENT

Container Steriltechnik  
Container Sterilization Technique

Endoskopie  
Endoscopy

Orthopädie  
Orthopedic

HERCULES® Drahtkneifzange  
HERCULES® Wire Cutters

Titan Instrumente  
Titanium Instruments



---

Maltepe Mah.  
Eski Çırpıcıyolu Sk.  
Merter İş Merkezi D Blok  
2/21 034234  
Zeytinburnu, İstanbul

+90 212 482 71 52  
[info@redamed.com](mailto:info@redamed.com)

---