



+Redamed



*Orthopädie
Instrumente*

*Orthopedic
Instruments*

*Instrumentos
para ortopédia*

*Strumenti
per ortopedia*



Maltepe Mah.Eski ırpıcıyolu Sk.
Merter İş Merkezi D Blok 2/21
034234- Zeytinburnu, İstanbul
+90 532 576 7332
+90 212 482 71 52
info@redamed.com

Perkussionshämmer
Percussion Hammers
Martillos de percusión
Martelli da percussione



TAYLOR - USA Mod.
03288-17 17 cm, 6 3/4"
03288-20 20 cm, 8"



BABINSKY
03292-22 22 cm, 8 3/4"

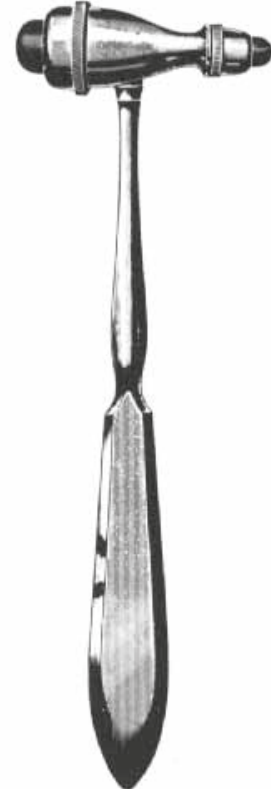

TROEMNER
03294-24 24 cm, 9 1/2"



DEJERINE
03304-20 20 cm, 8"



BERLINER
03306-17 17 cm, 6 3/4"

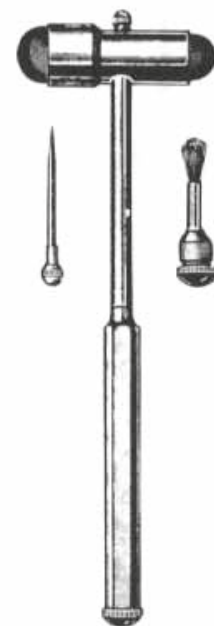

BUCK
03308-18 18 cm, 7"

Prüf- und Meßinstrumente
 Examination and Measuring Instruments
 Instrumentos para exámenes y medidas
 Strumenti per esaminare e misurare

Dynamometer
 Dynamometer
 Dinamómetro
 Dinamometro



COLLIN
 03310-01 Erwachsene, Adult,
 adultos, adulti
 03310-02 Kind, child, niños, bambini

Winkelmesser
 Goniometer
 Goniómetro
 Goniometro



MOELTGEN
 03312-01

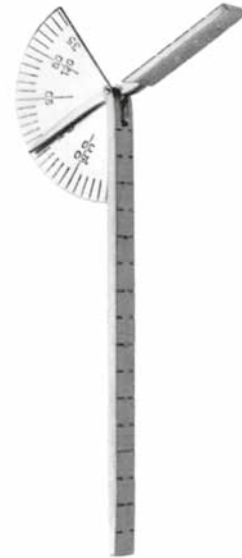

Finger-Goniometer
 Finger goniometer
 Goniómetro para dedos
 Goniometro per le dita
 03314-01



WARTENBERG
 03320-19 19 cm, 7 1/2"



aus Stahl
 of steel
 de acero
 di acciaio
 03350-15 1,5 m 0.6"

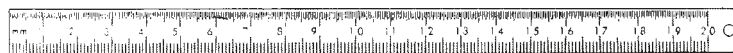

Metall
 03340-10 10 cm 4"
 03340-15 15 cm 6"
 03340-20 20 cm 8"
 03340-30 30 cm 12"
 03340-50 50 cm 20"

Schieblehren
Calipers
Calibres
Calibro

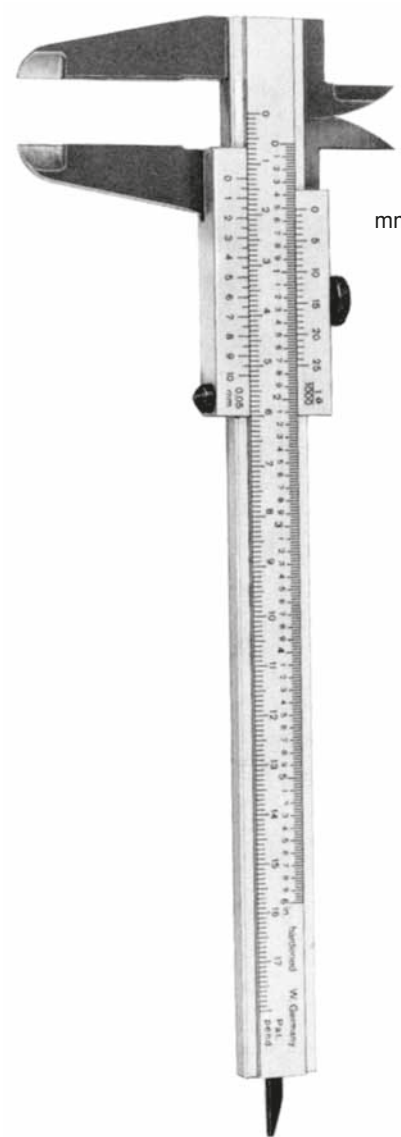

mm / inches

03360-21
21 cm, 8 1/4"



Townley
Femur Schieblehre
03361-10
10 cm, 4"

Saugrohre
Suction tubes
Tubos de aspiración
Cannule per aspirazione



POOLE
05130-10 10 mm \varnothing , 0.4"
(30 Fr.)
22 cm, 8 $\frac{3}{4}$ "



POOLE
05140-08 8 mm \varnothing , 0.3"
(23 Fr.)
22 cm, 8 $\frac{3}{4}$ "

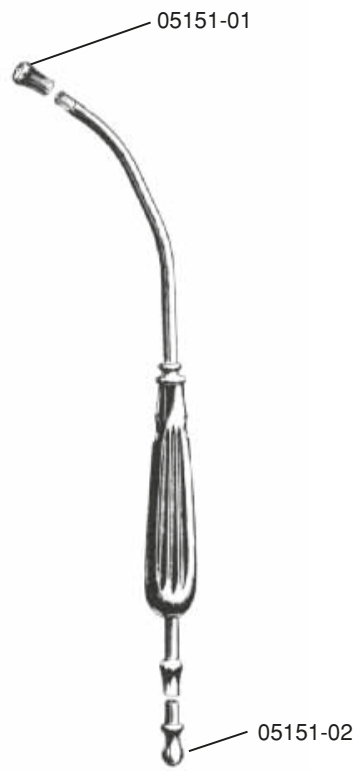

compl. BABY-YANKAUER
05150-21 21 cm, 8 $\frac{1}{4}$ "
compl. YANKAUER
05150-27 27 cm, 10 $\frac{1}{2}$ "

Saugrohre
Suction tubes
Tubos de aspiración
Cannule per aspirazione

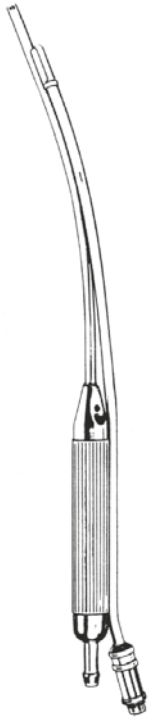

COOLEY
05160-01
8 mm \varnothing , 0.3" / 36 cm, 14 1/4"
mit Kaltlicht
with cold-light
con luz fria
con luce fredda



COOLEY
05160-02
8 mm \varnothing , 0.3"
36 cm
14 1/4"



COOLEY
05160-03
8 mm \varnothing , 0.3"
30 cm
11 3/4"



DE BAKEY
05160-04
3 mm \varnothing , 0.1"



ANDREW-PYNCHON
05170-24
6 mm \varnothing , 1/2"
24 cm, 9 1/2"

Skalpelli-Griffe
 Scalpel Handles
 Mangos de bisturíes
 Manici per lama bisturi

passend zu den Klingen
 for blades
 para las hojas
 per lama bisturi

(A) No. 10, 11, 12, 13, 14, 15, 16, 17, 18, 19

(B) No. 20, 21, 22, 23, 24, 25

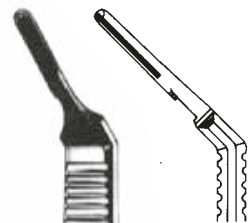

07103-00
 Fig. 3

(A)



07103-01
 Fig. 3 grad.

(A)



07103-02
 Fig. 3 L

(A)



07109-03
 Fig. 3 L

(A)

Skalpelli-Griffe
Scalpel Handles
Mangos de bisturís
Manici per lama bisturi

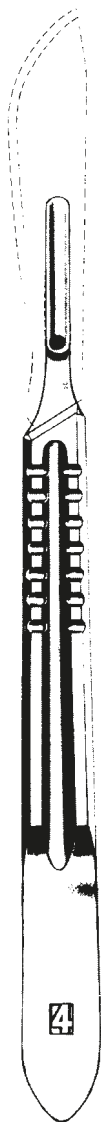

07104-00
Fig. 4

(B)

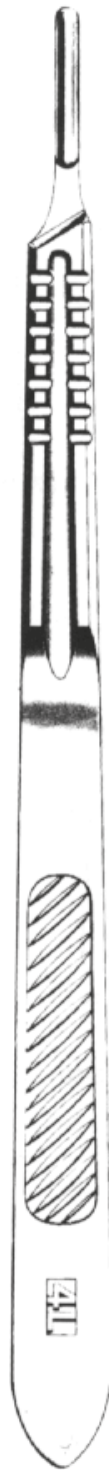

07104-02
Fig. 4 L

(B)

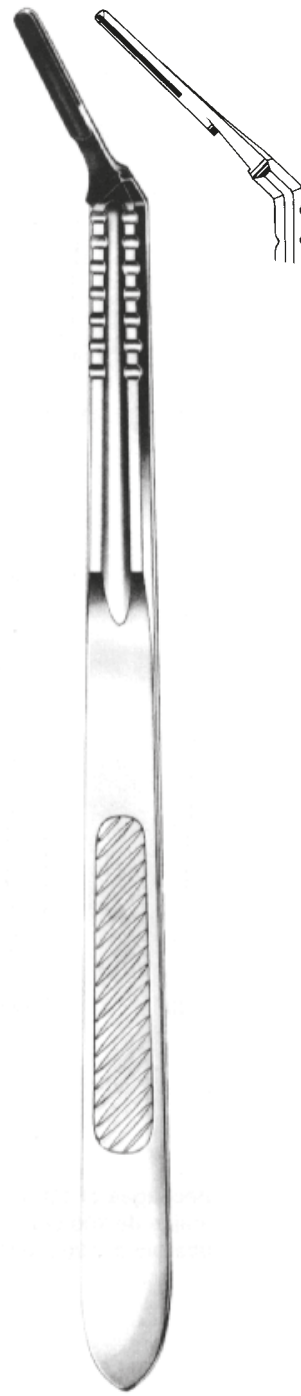

07105-02
Fig. 4 L

(B)

Skalpelli-Griffe
Scalpel Handles
Mangos de bisturíes
Manici per lama bisturi



07107-00
Fig. 7

(A)



07107-01
Fig. 7K

(A)



07108-00
Fig. 8

(B)

Skalpelli-Griffe
Scalpel Handles
Mangos de bisturíes
Manici per lama bisturi



07161-00 07162-00 07165-00 07167-00

Packung mit 10 Stück
box of 10
en cajas de 10
confezione di 10

07109-10 10,0 cm, 4"
07109-13 13,0 cm, 5"
07109-15 15,5 cm, 6"

Skalpell-Klingen, Steril
 Scalpel Blades, Sterile
 Hojas de bisturí, estéril
 Lame per bisturi, sterili

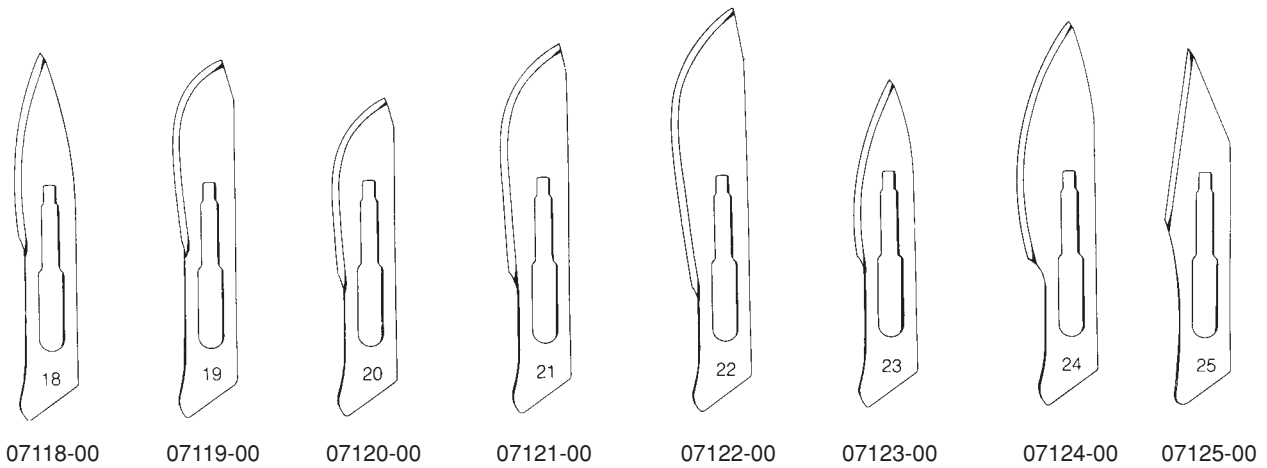
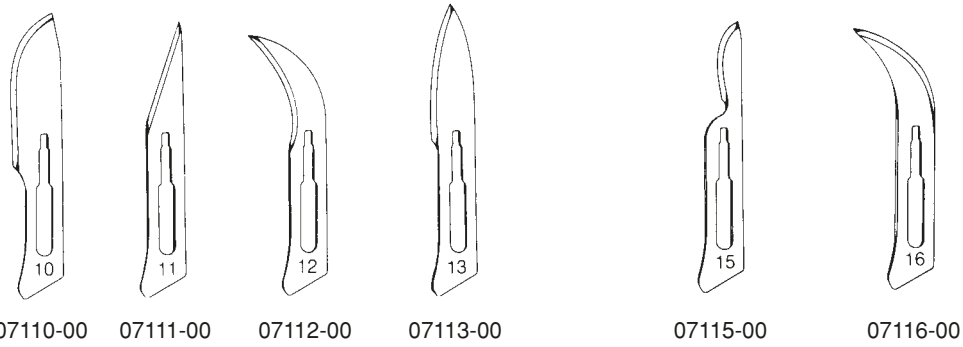

Produktionscharge
 Prod. Charge
 Numero di serie

Verfalldatum/Herstellungsdatum
 expire date/prod. date
 Data di scadenza

Indikator
 Indicator
 Indicatore

**Packung mit 100 Stück
 in packages of 100 each
 en cajas de 100 c/u
 confezione di 100 pezzi**



Skalpellklingen-Entferner
 Scalpel Blade Remover
 Quita hojas
 Distributore lame

Amputationsmesser
Amputation Knives
Cuchillos para amputaciòn
Coltelli per amputazione

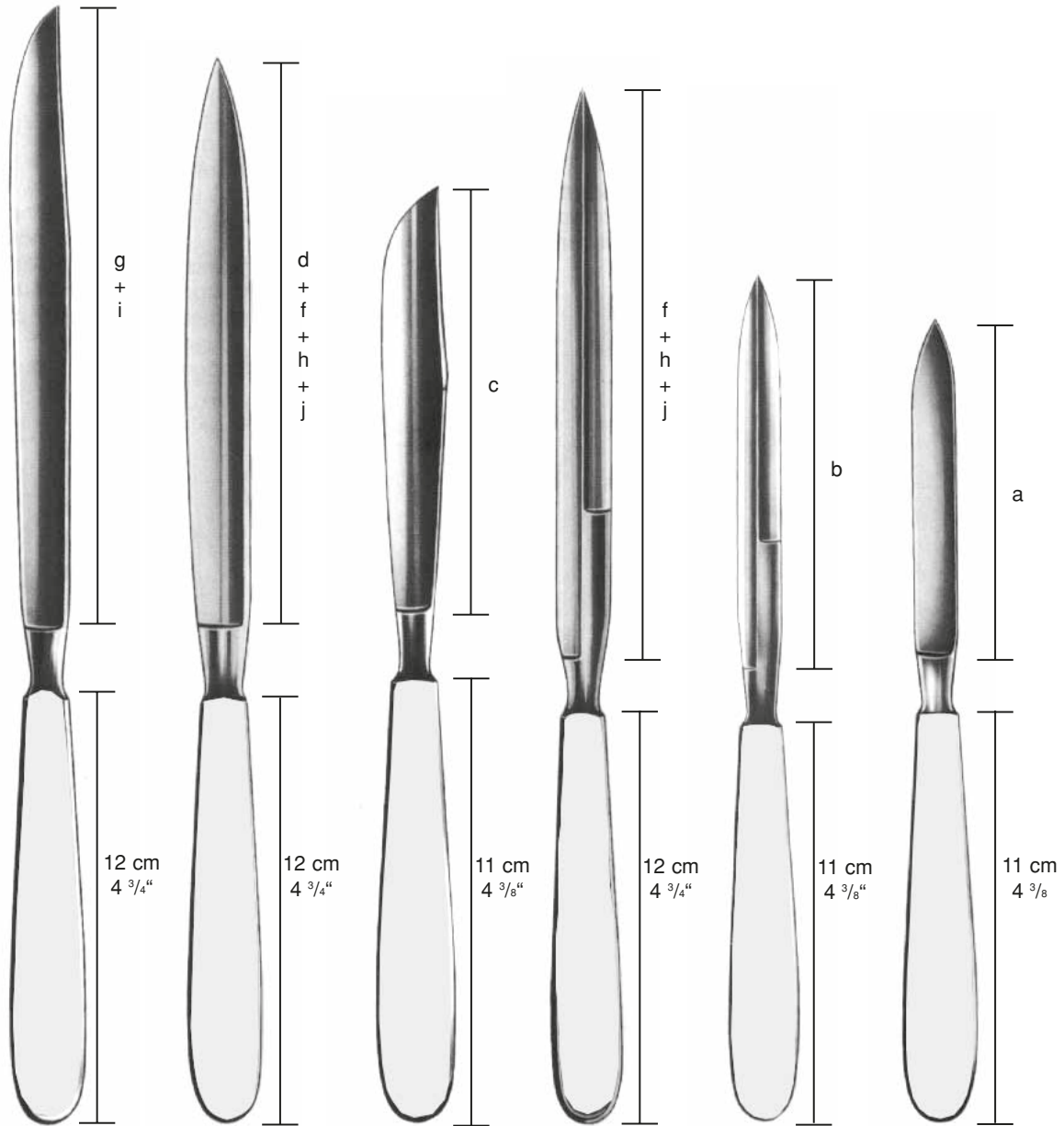

Liston
07200-17
07200-20

Reda
07201-13
07201-16
07201-19
07201-22

Langenbeck
07202-12

Catlin
doppelschneidig
double
aftingedeges
filo doble
doppio taglio
07203-16
07203-19
07203-22

07204-11
Zwischenknochen-
messer doppel-
schneidig
Inerosseous knife
double aftingedeges
Cuchillo interòseo
filo doble
Coltello interosseo
doppio taglio

07205-09
Phalangen-
messer
Phalangeal knife
Cuchillos para
falanges
Coltello per falangi

Schnittlänge
Length of blades
Largo de hojas
Lunghezze delle lame

a - 9,5 cm	c - 12,0 cm	e - 15,0 cm	g - 17,0 cm	i - 20,0 cm
b - 11,0 cm	d - 13,0 cm	f - 16,0 cm	h - 19,0 cm	j - 22,0 cm
a - 3 3/4"	c - 4 3/4"	e - 6"	g - 6 3/4"	i - 8"
b - 4 3/8"	d - 5"	f - 6 1/4"	h - 7 1/2"	j - 8 3/4"

Chirurgische Scheren
Operating Scissors
Tijeras para cirugía
Forbici per chirurgia



STANDARD
09102-11 11,5 cm, 4 1/2"
09102-13 13,0 cm, 5"
09102-14 14,5 cm, 5 3/4"
09104-14 TC
09102-15 15,5 cm, 6"
09102-16 16,5 cm, 6 1/2"
09102-18 18,5 cm, 7 1/4"
09102-20 20,0 cm, 8"



STANDARD
09110-11 11,5 cm, 4 1/2"
09110-13 13,0 cm, 5"
09110-14 14,5 cm, 5 3/4"
09114-14 TC
09110-15 15,5 cm, 6"
09110-16 16,5 cm, 6 1/2"
09110-18 18,5 cm, 7 1/4"
09110-20 20,0 cm, 8"

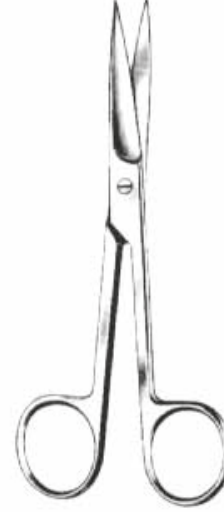

STANDARD
09120-11 11,5 cm, 4 1/2"
09120-13 13,0 cm, 5"
09120-14 14,5 cm, 5 3/4"
09124-14 TC
09120-15 15,5 cm, 6"
09120-16 16,5 cm, 6 1/2"
09120-18 18,5 cm, 7 1/4"
09120-20 20,0 cm, 8"



STANDARD
09103-11 11,5 cm, 4 1/2"
09103-13 13,0 cm, 5"
09103-14 14,5 cm, 5 3/4"
09105-14 TC
09103-15 15,5 cm, 6"
09103-16 16,5 cm, 6 1/2"
09103-18 18,5 cm, 7 1/4"
09103-20 20,0 cm, 8"



STANDARD
09111-11 11,5 cm, 4 1/2"
09111-13 13,0 cm, 5"
09111-14 14,5 cm, 5 3/4"
09115-14 TC
09111-15 15,5 cm, 6"
09111-16 16,5 cm, 6 1/2"
09111-18 18,5 cm, 7 1/4"
09111-20 20,0 cm, 8"

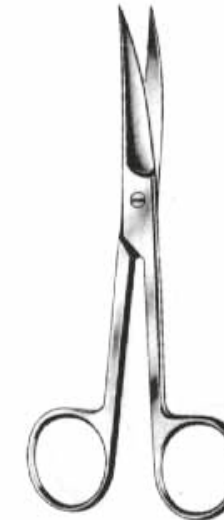

STANDARD
09121-11 11,5 cm, 4 1/2"
09121-13 13,0 cm, 5"
09121-14 14,5 cm, 5 3/4"
09125-14 TC
09121-15 15,5 cm, 6"
09121-16 16,5 cm, 6 1/2"
09121-18 18,5 cm, 7 1/4"
09121-20 20,0 cm, 8"

Scheren, Ophthal, Nase
 Scissors, Ophthal, Nasal
 Tijeras, oftalmología, nasales
 Forbici, oftalmologia, nasali

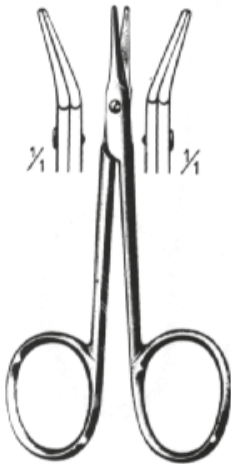

AEBLI
 09347-09 9 cm 09349-09
 3 1/2"

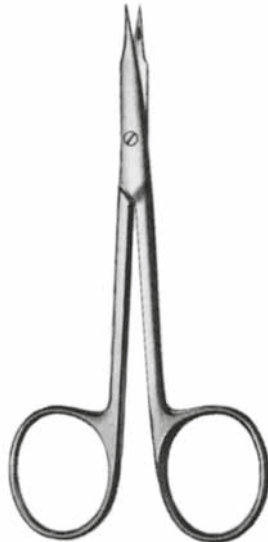

STEVENS
 11 cm
 4 3/8"



09360-11 09361-11 09362-11 09363-11



STRABISMUS
 09370-11 09371-11
09374-11 TC 09375-11 TC
 11 cm, 4 3/8"

Chirurgische Scheren
Operating Scissors
Tijeras para cirugía
Forbici per chirurgia

Zahnfleischscheren
Gum Scissors
Tijeras para encías
Forbici gingivali

1 Schneide gezahnt
1 blade toothed
1 hoja dentada
1 taglio della lama dentellato

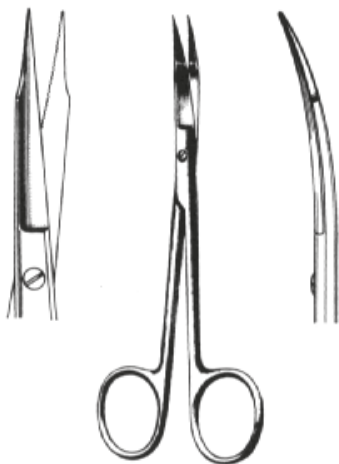

GOLDMAN-FOX
09820-13 13 cm, 5 1/8" 09821-13

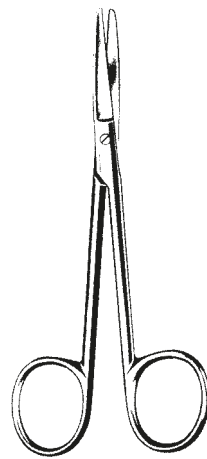

WAGNER
12 cm, 4 3/4"

gerade
straight
rectas
rette

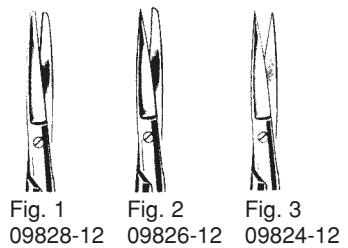

Fig. 1 09828-12 Fig. 2 09826-12 Fig. 3 09824-12

gebogen
curved
curvas
curve

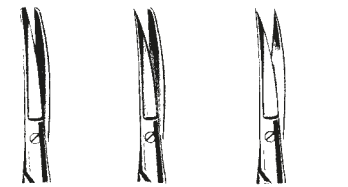

Fig. 1 09823-12 Fig. 2 09829-12 Fig. 3 09825-12

Draht-, Blechscheren
Wire and plate shears
Tijeras para alambre y láminas
Forbici per filo di metallo e lamiera



QUINBY
09827-12 12 cm, 4 3/4"



UNIVERSAL
09831-12 12 cm, 4 3/4"
09835-12 TC 12 cm, 4 3/4"

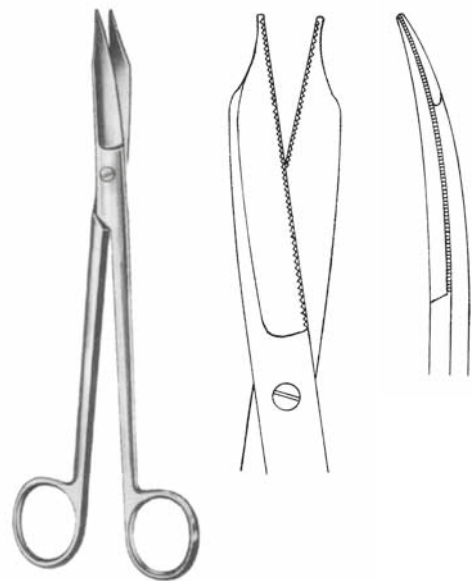

MARTIN
09841-20 20 cm, 8"

Verbandscheren
 Bandage Scissors
 Tijeras para vendajes
 Forbici per bendaggi

Gaze
 Gauze
 Gaza
 Garza



SMITH US ARMY
 09898-20
 20 cm, 8"

- 9 cm, 3 1/2"
- 11 cm, 4 3/8"
- 14 cm, 5 1/2"
- 18 cm, 7"
- 20 cm, 8"



LISTER
 09901-09
 09901-11
 09901-14
 09901-18
 09901-20

09905-14 TC
 09905-18 TC



LISTER
 09906-18 18 cm, 7"
 09906-20 20 cm, 8"



BERGMANN
 09911-23
 23 cm, 9"



ESMARCH
 09913-20 20 cm, 8"
 09913-22 22 cm, 8 3/4"



SEUTIN
 09915-23
 23 cm, 9"

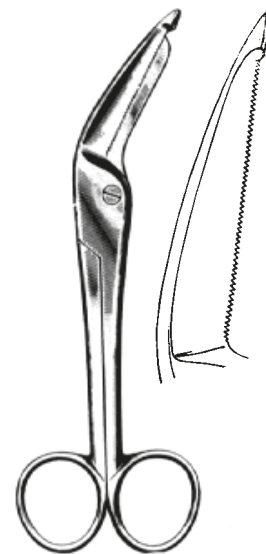

REDA EXCENTER
 09921-16 16 cm, 6 1/4"
 09921-19 19 cm, 7 1/2"
 gezahnt
 toothed
 dentadas
 dentellata

Verbandscheren
Bandage Scissors
Tijeras para vendajes
Forbici per bendaggi



KNOWLES
09930-14
14 cm, 5 1/2"

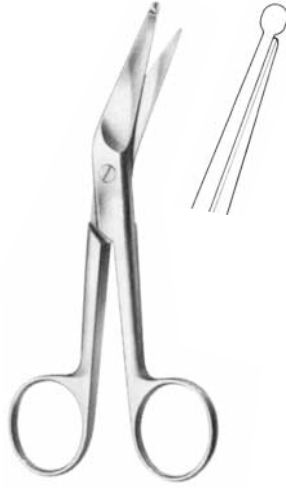

KNOWLES
09931-14
14 cm, 5 1/2"



LORENZ
09933-23
23 cm, 9"



BRUNS
09935-23 23 cm, 9" **09939-23 TC**
09937-23 23 cm, 9"



09941-20
20 cm, 8"

in verschiedenen Farben
in different colours
en diferentes colores
in differenti colori



UNIVERSAL
09950-15 15 cm, 6"
09950-18 18 cm, 7"

Supercut Scheren
 Supercut Scissors
 Tijeras Supercut
 Forbici Supercut



gezahnt
 saw edge
 dentadas
 dentellate

14,5 cm, 5 3/4"
 gerade gebogen
 straight curved
 rectas curvas
 rette curve
 09960-14 09961-14



gezahnt
 saw edge
 dentadas
 dentellate

MAYO
 gerade gebogen
 straight curved
 rectas curvas
 rette curve
 09962-14 14,5 cm 09963-14
 09962-17 17,0 cm 09963-17
 09962-23 23,0 cm 09963-23



gezahnt
 saw edge
 dentadas
 dentellate

MAYO-STILLE
 gerade gebogen
 straight curved
 rectas curvas
 rette curve
 09964-15 15,0 cm 09965-15
 09964-17 17,0 cm 09965-17



gezahnt
 saw edge
 dentadas
 dentellate

BABY METZENBAUM
 11,5 cm, 4 1/2"
 gerade gebogen
 straight curved
 rectas curvas
 rette curve
 09966-11 09967-11



gezahnt
 saw edge
 dentadas
 dentellate

METZENBAUM
 gerade gebogen
 straight curved
 rectas curvas
 rette curve
 09970-14 14,5 cm 09971-14
 09970-18 18,0 cm 09971-18
 09970-20 20,0 cm 09971-20
 09970-23 23,0 cm 09971-23

Supercut Scheren
Supercut Scissors
Tijeras Supercut
Forbici Supercut



gezahnt
saw edge
dentadas
dentellate

IRIS
11,5 cm, 4 1/2"
gerade gebogen
straight curved
rectas curvas
rette curve
09980-11 09981-11



gezahnt
saw edge
dentadas
dentellate

WAGNER
12 cm, 4 3/4"
gerade gebogen
straight curved
rectas curvas
rette curve
09982-12 09983-12



STEVENS
11,5 cm, 4 1/2"
gerade gebogen
straight curved
rectas curvas
rette curve
09984-11 09985-11



gezahnt
saw edge
dentadas
dentellate

LISTER
09990-14 14,5 cm, 5 3/4"
09990-18 18,0 cm, 7"



REYNOLDS
09993-15 15 cm, 6"



KILNER/RAGNELL
09995-12 12 cm, 4 3/4"

Häkchen
Hooks
Ganchitos
Uncini



19219-15
15 cm, 6"



Reda
16 cm, 6 1/4"



19220-01



19220-02



19220-03



19220-04



Reda
16 cm, 6 1/4"



19221-01



19221-02



19221-03



19221-04



Reda, flexibel
16 cm, 6 1/4"

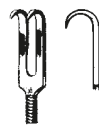

19226-02

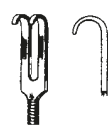

19227-02

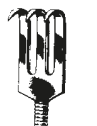

19226-03



19227-03



19226-04



19227-04



KLAPP
17,5 cm, 6.9"



19229-02



19229-03

Häkchen
Hooks
Ganchitos
Uncini



19270-02

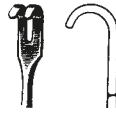

19271-02



VOLKMANN
11,5 cm, 4 1/2"



19270-03



19271-03



19270-04



19271-04



19270-06



19271-06



19293-18
18 cm, 7"

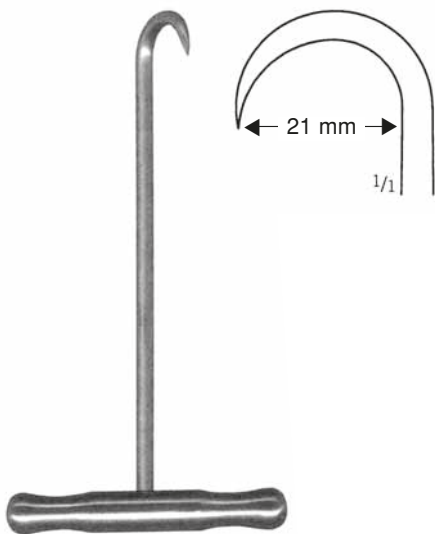

19294-20
18 cm, 7"

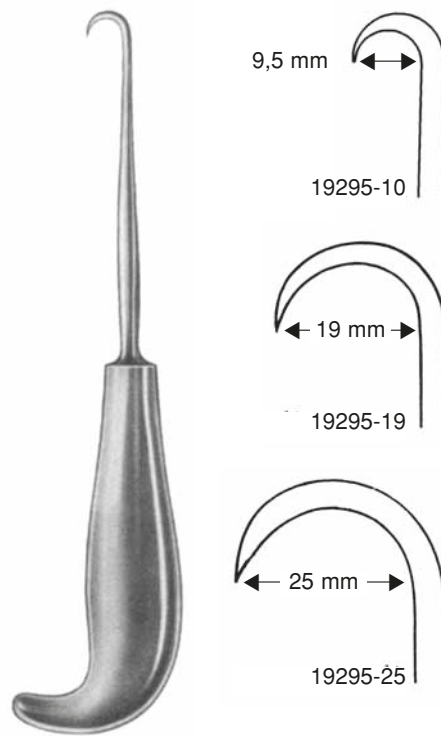

23 cm, 9"

Wundhaken
Retractors
Separadores
Divaricatori

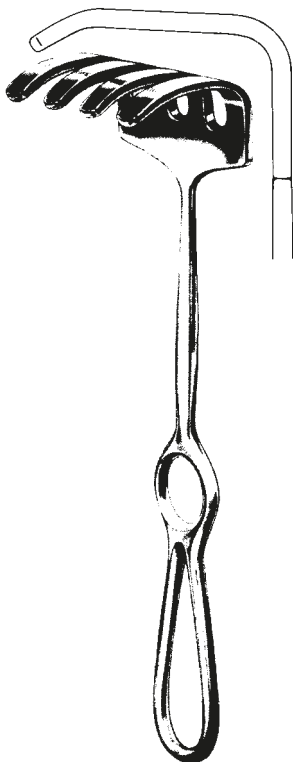

OLLIER
19360-04 22,5 cm, 8.9"

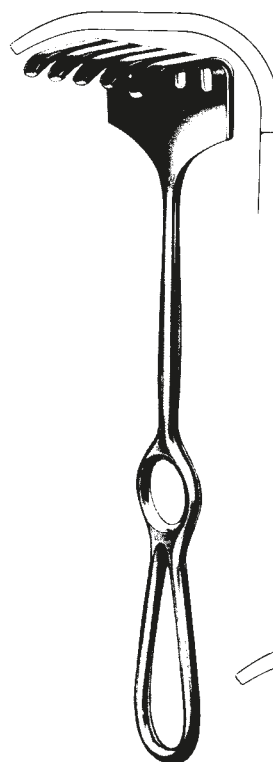

ISRAEL
19364-40 40x40 mm
25 cm, 10"

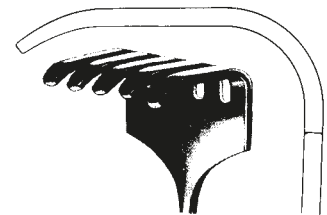

19364-50 45x50 mm

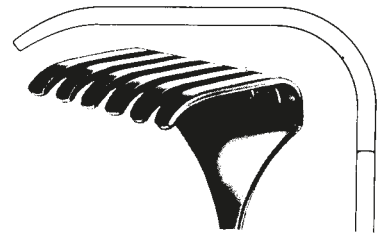

19364-60 50x60 mm



19364-70 70x70 mm

Wundhaken
Retractors
Separadores
Divaricatori

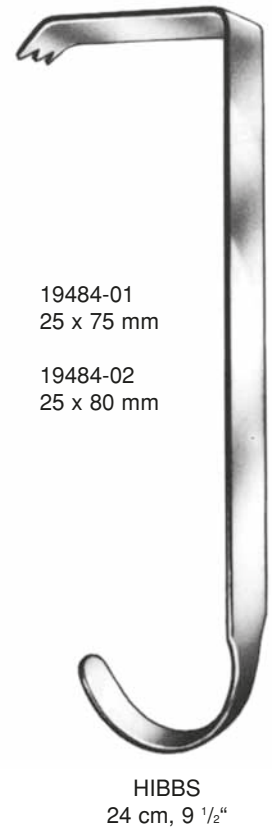
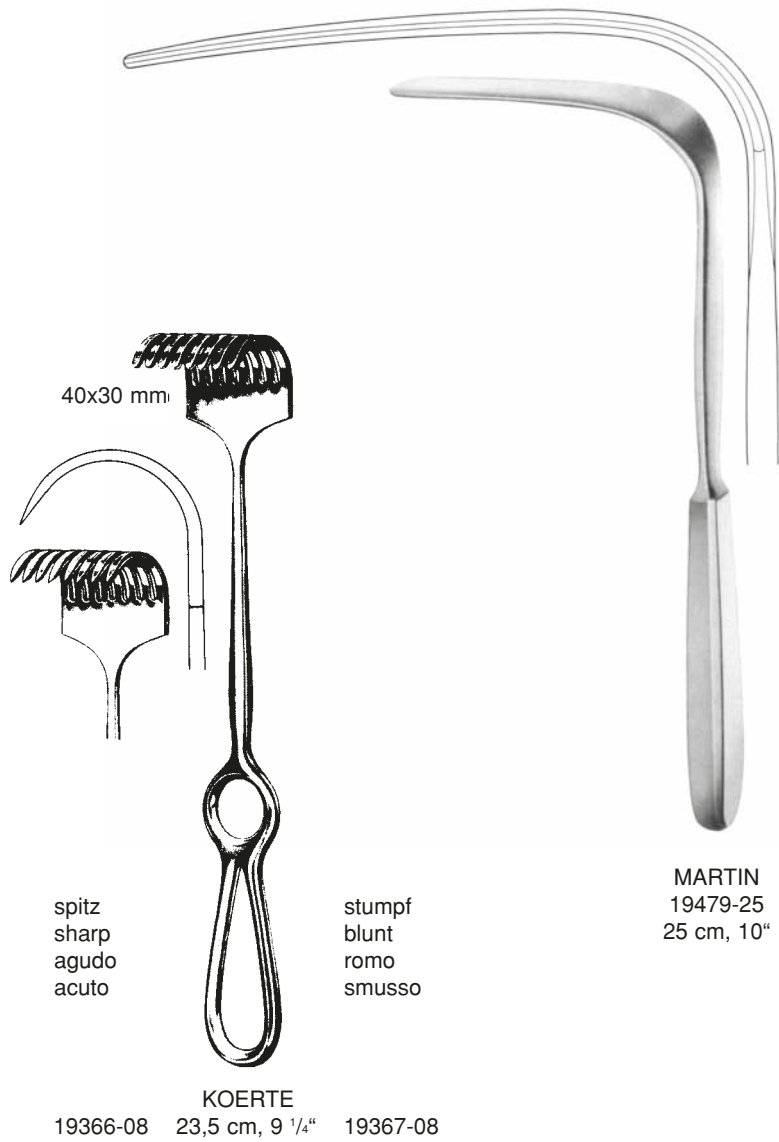

Wundsperrer
Retractors
Separadores
Divaricatori

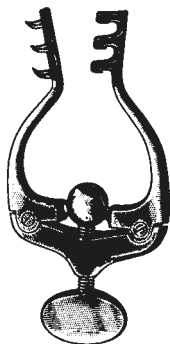
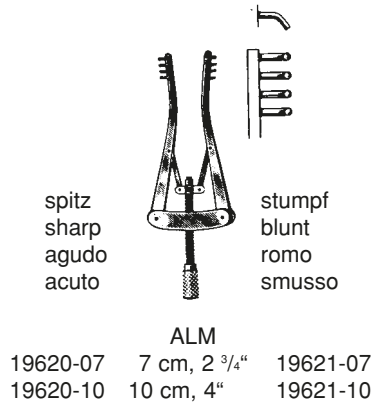
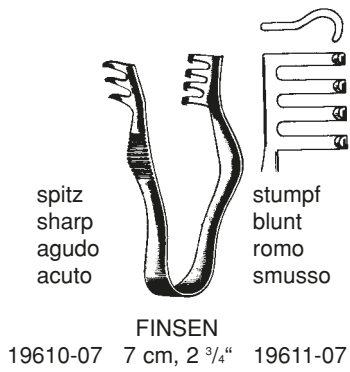

JANSSEN
19630-10
10 cm, 4"

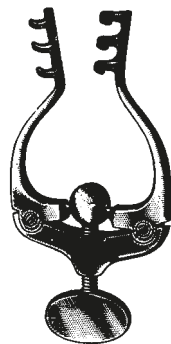

JANSSEN
19631-10
10 cm, 4"

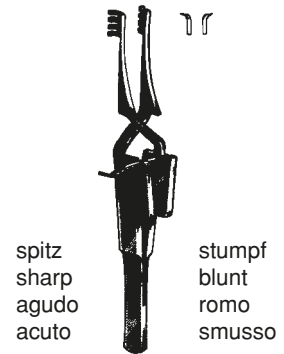

HOLZHEIMER
19634-10 19635-10
10 cm, 4"

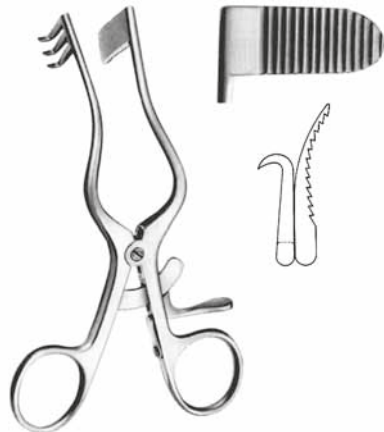

PERKINS
19636-14
13 cm, 5 1/8"

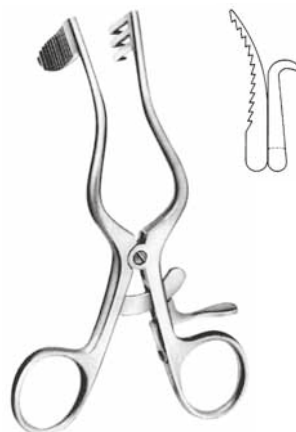

PERKINS
19637-14
13 cm, 5 1/8"

Wundsperrer
Retractors
Separadores
Divaricatori

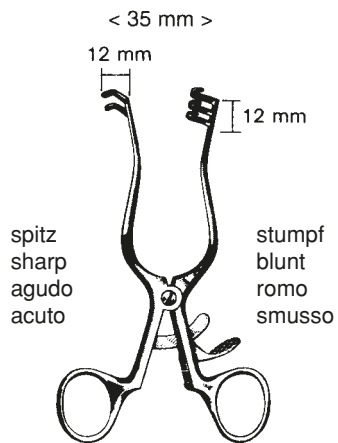

spitz
sharp
agudo
acuto

stumpf
blunt
romo
smusso

WEITLANER
19650-10 19651-10
11,5 cm, 4 1/2"

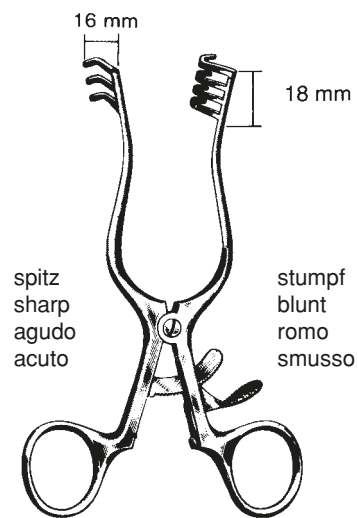

spitz
sharp
agudo
acuto

stumpf
blunt
romo
smusso

WEITLANER
19670-14 14,0 cm, 5 1/2" 19671-14
19670-16 16,5 cm, 6 1/2" 19671-16
19670-20 20,0 cm, 8" 19671-20
19670-24 24,0 cm, 9 1/2" 19671-24

Wundsperrer
Retractors
Separadores
Divaricatori

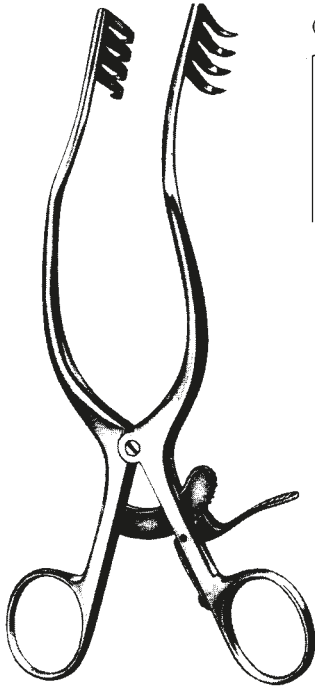

ANDERSON ADSON
19679-20 19,5 cm, 7 3/4"



NORFOLK / NORWICH
19679-22 22 cm, 8 3/4"

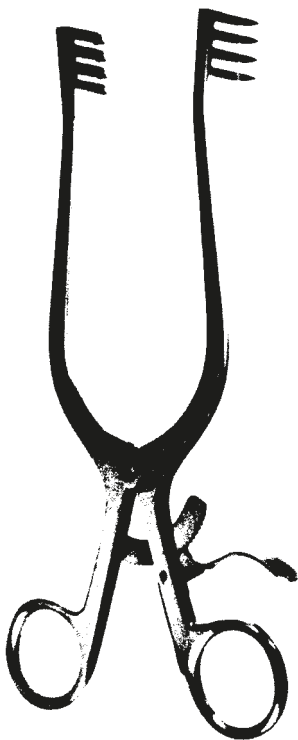

spitz
sharp
agudo
acuto

ADSON
19680-19 19 cm, 7 1/2" 19681-19

stumpf
blunt
romo
smusso

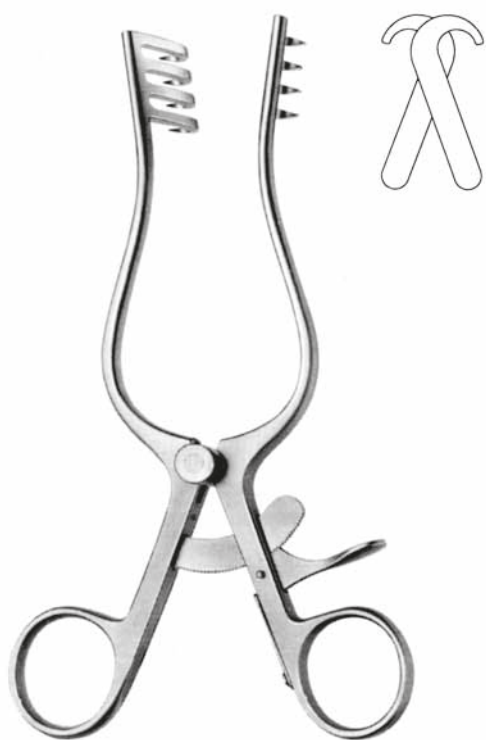

TRAVERS
19681-21 21,5 cm, 8 1/2"

Wundsperrer
Retractors
Separadores
Divaricatori

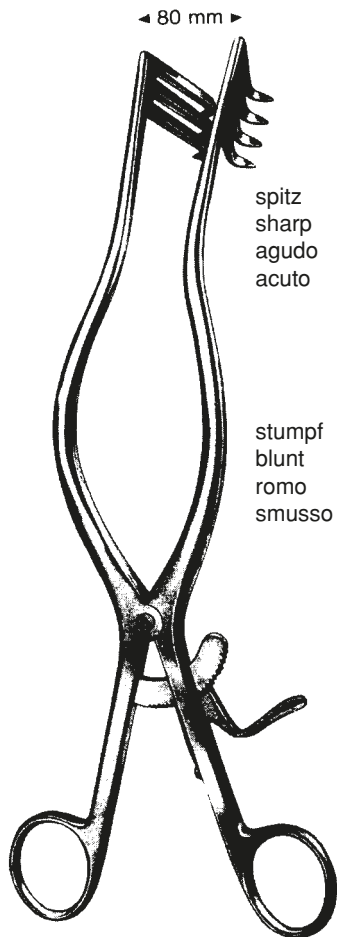

ADSON
19682-26 - 19683-26
26,5 cm, 10 1/2"

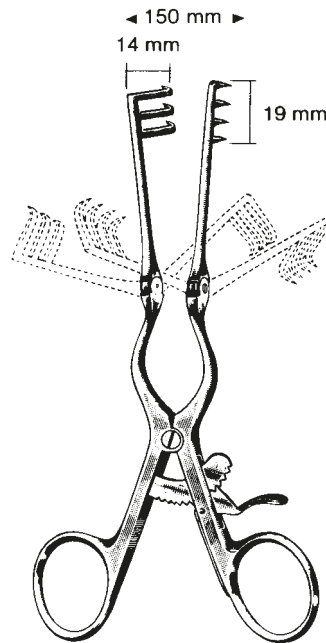
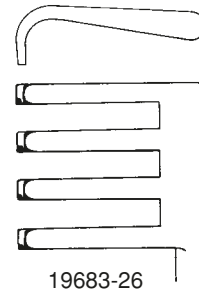
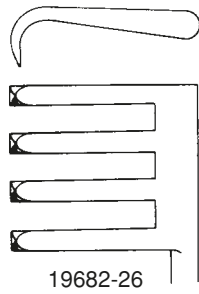

ADSON

- 19684-14 14 cm, 5 1/2"
- 19684-16 16 cm, 6 1/4"
- 19684-20 20 cm, 8"
- 19684-26 26 cm, 10 1/4"

spitz
sharp
agudo
acuto

- 19685-14 14 cm, 5 1/2"
- 19685-16 16 cm, 6 1/4"
- 19685-20 20 cm, 8"
- 19685-26 26 cm, 10 1/4"

stumpf
blunt
romo
smusso

Wundsperrer
Retractors
Separadores
Divaricatori



ADSON
19686-32
32 cm, 12 3/4"

Wundsperrer
Retractors
Separadores
Divaricatori



Beckman-Adson
31 cm, 12 1/4"

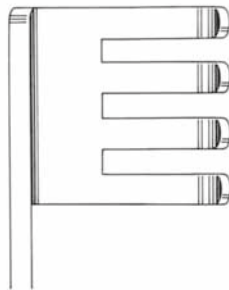

19687-01
25 x 27 mm

stumpf
blunt
romo
smusso

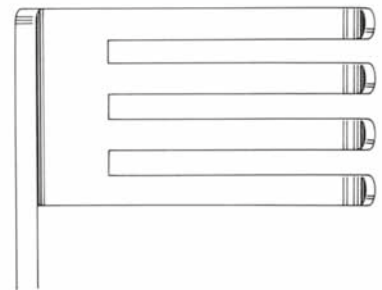

19688-01
45 x 27 mm

stumpf
blunt
romo
smusso

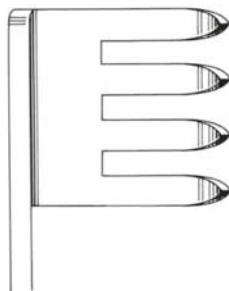

19687-02
25 x 27 mm

scharf
sharp
agudo
acuto

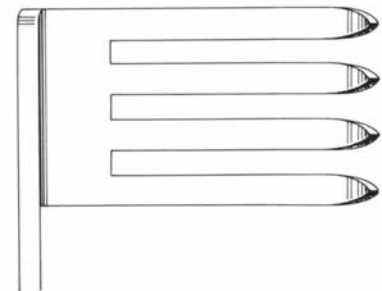

19688-02
45 x 27 mm

scharf
sharp
agudo
acuto

Wundsperrer
Retractors
Separadores
Divaricatori

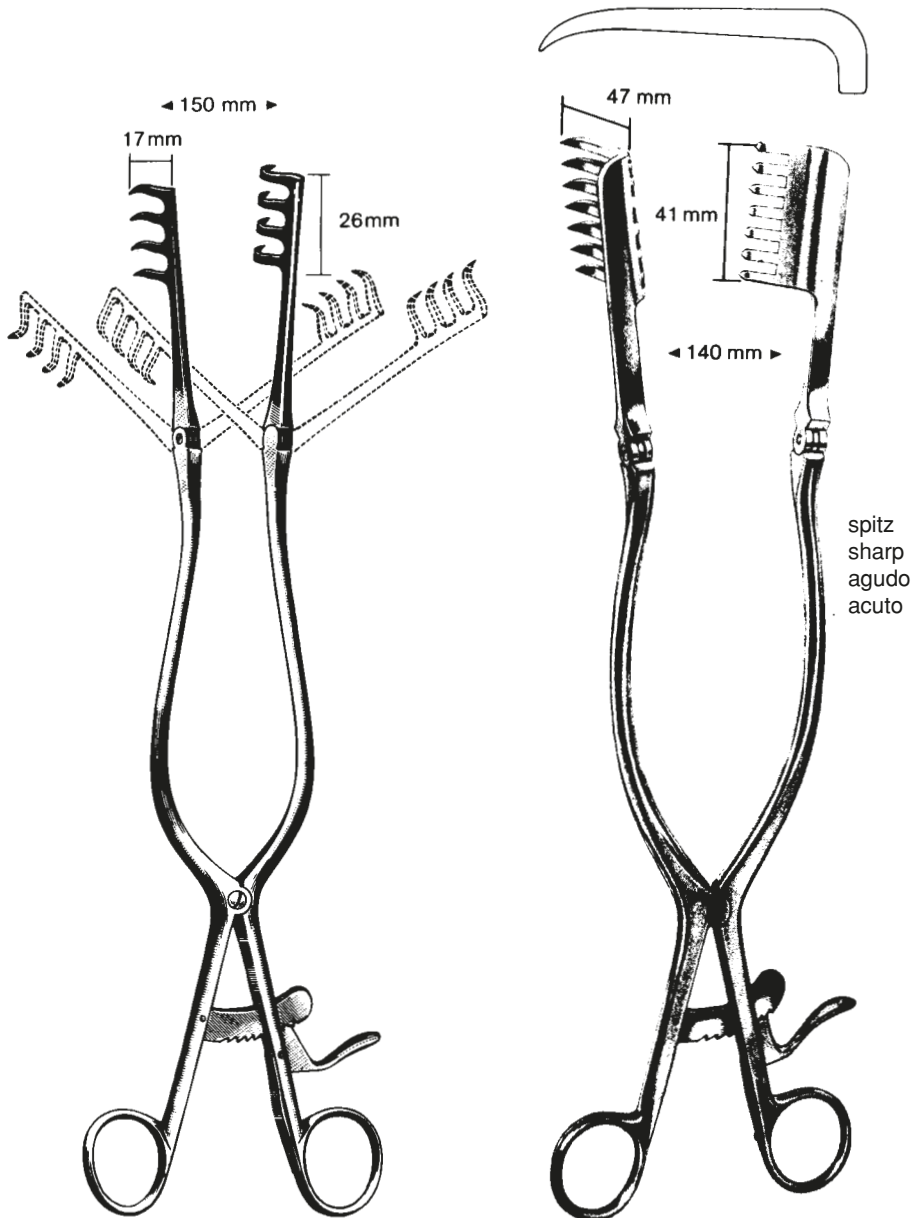

BECKMANN
19690-31
31 cm, 12 1/4"

BECKMANN-EATON
19692-32
32 cm, 12 3/4"

Wundhaken
Retractors
Separadores
Divaricatori

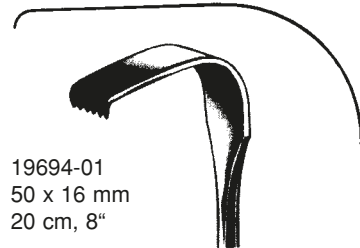

19694-01
50 x 16 mm
20 cm, 8"

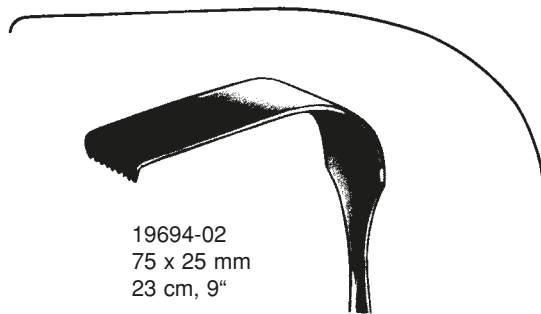

19694-02
75 x 25 mm
23 cm, 9"



19694-03
90 x 50 mm
24 cm, 9 1/2"

MEYERDING

Wundsperrer
 Retractors
 Separadores
 Divaricatori

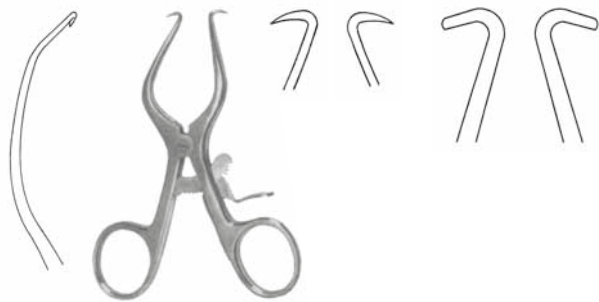

GELPI

- 19802-09 9 cm, 3 1/2"
- 19802-11 11 cm, 4 3/8"
- 19802-14 14 cm, 5 1/2"
- 19802-16 16 cm, 6 1/4"
- 19802-18 18 cm, 7"



19803-16 16 cm, 6 1/4"

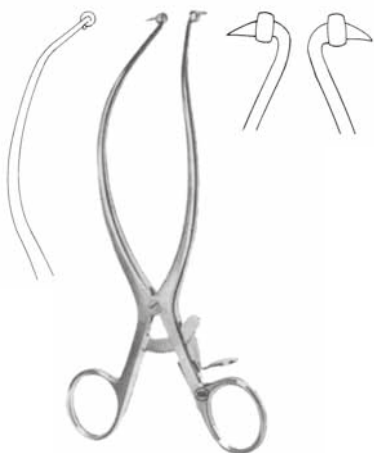

19804-18
 18 cm, 7"

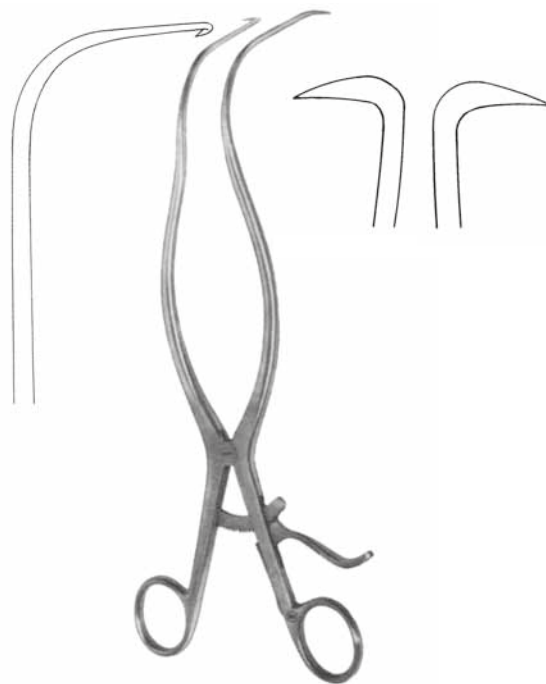

WILTSE-GELPI
 28 cm, 11"
 19805-28

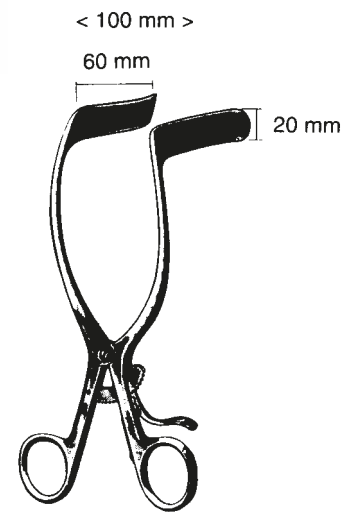

RIGBY
 19806-18
 18 cm, 7"

Gipsscheren
Plaster of Paris Shears
Cizallas para vendajes enyesados
Cesoie per gessi

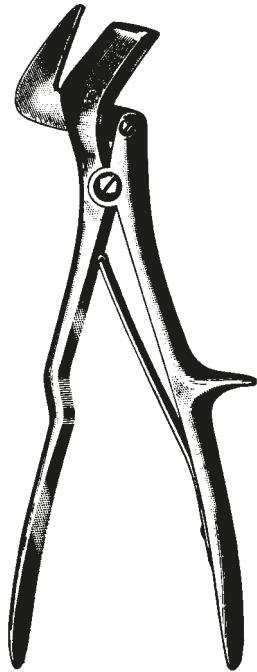

STILLÉ
31101-24 24 cm, 9 1/2"



STILLÉ
31103-23 23 cm, 9"
31103-26 26 cm, 10 1/4"
31103-37 37 cm, 14 1/2"



WIGMORE
31120-19 19 cm, 7 1/2"

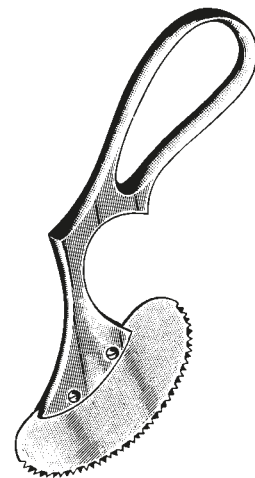

ENGEL
31130-14

Oscillierende Gipssäge
 Oscillating Plaster Saw
 Sierra oscilante p. vendajes enyesados
 Sega oscillante per Gessi

Elektrische Gipssäge
 Electric Plaster Cast Cutter
 Sierra eléctrica para yesos
 Sega elettrica per gessi



31210-21 110 Volt, compl. of Art.-Nr. 31212-02/31210-50/31210-65
 31210-22 230 Volt, compl. of Art.-Nr. 31212-02/31210-50/31210-65

Geräuschpegel min. 63 max. 69 DB
 Noise level machine only: Min. 63 Max. 69 db/(A)
 Nivel de ruido del aparato sólo 63 dB (mín.), 69 dB/(A)
 Livello acustico dello strumento solo: min. 63 max. 69 db/(A)

EN 60601-1, EN 60601-1-2, IEC 60601-1, IEC 60601-1-2



31212-02
 Schraubenschlüssel
 Spanners
 Laves

Paio di Chiavi per utilizzo cambio lame da sega

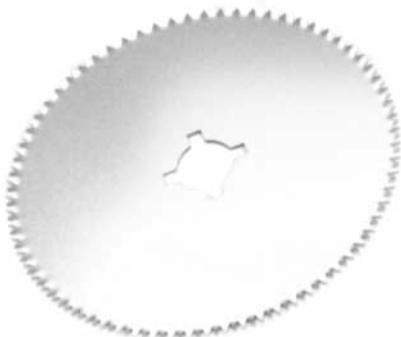

31210-50	50 mm (2.0") Ø	hard/dura *
31210-65	65 mm (2.6") Ø	hard/dura *
31211-50	50 mm (2.0") Ø	hard/dura *
31211-65	65 mm (2.6") Ø	hard/dura *

* Ersatz-Sägeblätter, spezialgehärtet (F. Fiberglas u. andere Hartverbände)
 * Spare saw blades, special hardness (for dressing of fiber glass for other hard dressing)
 * Hojas de repuesto, templadas especialmente (para vendajes de fibra de vidrio y otros vendajes duros)
 * Lame per sega a tempera speciale per bendaggi (in fibro di vetro ed altri bendaggi duri)

Oscillierende Gipssäge mit Staubabsauger
Oscillating Plaster Saw with plaster vacuum
Sierra oscillante con aspiración
Sega oscillante per gesso con aspirazione



Gipsspreizer, Gipsabreißzangen
Plaster Cast Instruments
Instrumentos para vendajes enyesados
Allargagessi, Strappagessi



HENNIG
31350-28 28 cm, 11"

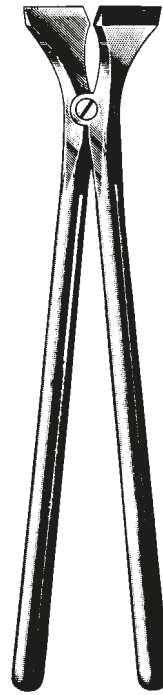

BEESON
31360-30 30 cm, 11 3/4"

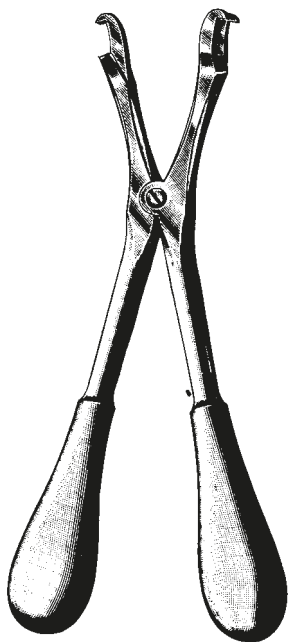

HAGLUND-STILLE
31362-28 28 cm, 11"



REDA
31366-23 23 cm, 9"

Gipsspreizer, Gipsmesser, Gipsabreißzangen
Plaster Cast Instruments, Knives
Instrumentos para vendajes enyesados, Cuchillos
Allargagessi, Coltelli per Gessi, Strappagessi



HOPKINS
31370-20
20 cm, 8"



ESMARCH
31380-18
18 cm, 7"

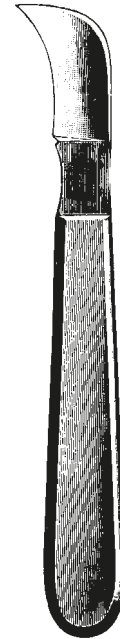

REINER
31390-18
18 cm, 7"

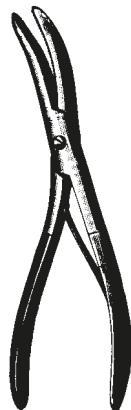

WOLFF
31395-18
18 cm, 7"

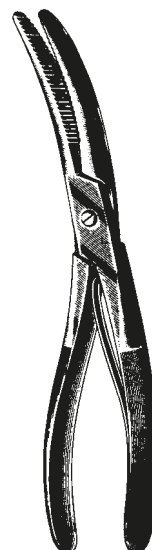

WOLFF
31397-24
24 cm, 9 1/2"

Hohlmeißelzangen
 Bone Rongeurs
 Pinzas-gubias
 Pinze sgorbie

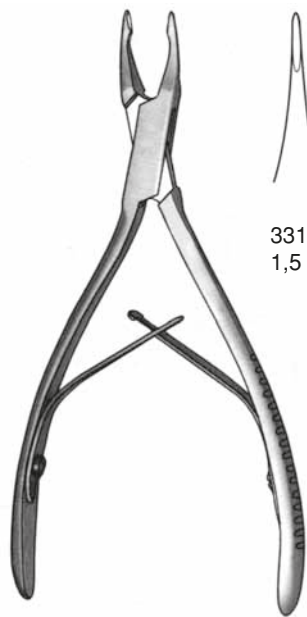

MICRO FRIEDMAN
 33100-02 14 cm, 5 1/2"



33100-01
 1,5 x 5 mm



33100-02
 1,5 x 5 mm

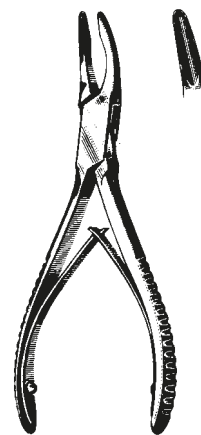

FRIEDMAN Mini
 33101-12 12 cm, 4 3/4"

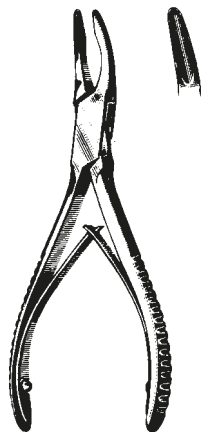

FRIEDMAN
 33101-14 14 cm, 5 1/2"



STELLBRINK
 33102-02 17 cm, 6 3/4"



33102-01
 2 mm



33102-02
 2 mm

Hohlmeißelzangen
Bone Rongeurs
Pinzas-gubias
Pinze sgorbie

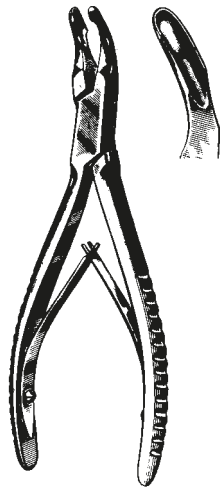

CLEVELAND
33103-14 14 cm, 5 1/2"

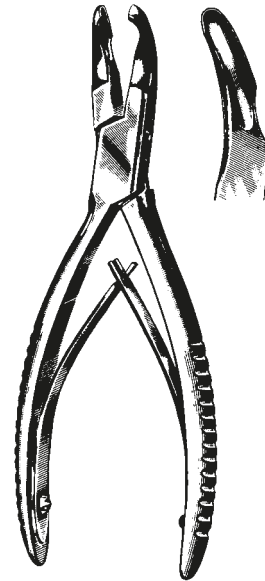

CLEVELAND
33105-17 17 cm, 6 3/4"

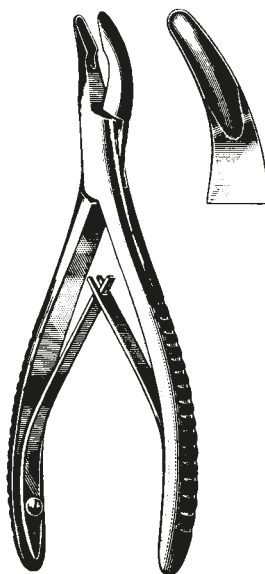

MEAD
33107-16 16,5 cm, 6 1/2"

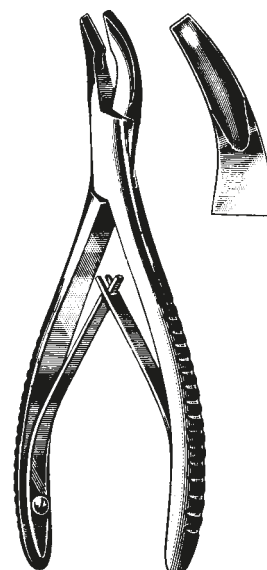

MEAD
33109-16 16,5 cm, 6 1/2"

Hohlmeißelzangen
 Bone Rongeurs
 Pinzas-gubias
 Pinze sgorbie

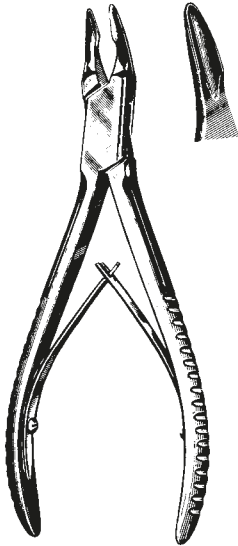

BLUMENTHAL
 33115-15
 15,5 cm, 6"

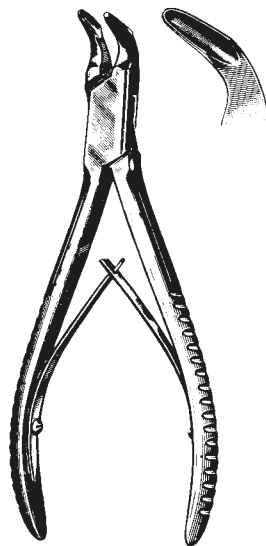

BLUMENTHAL
 33117-15
 15,5 cm, 6"

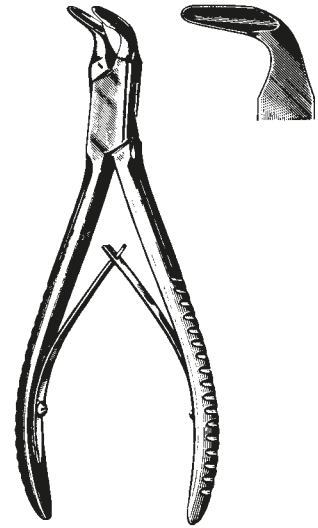

BLUMENTHAL
 33119-15
 15,5 cm, 6"

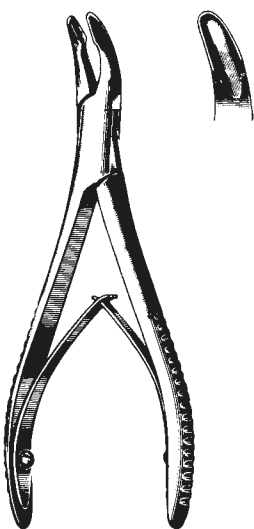

LUER
 33131-15
 15 cm, 5.9"

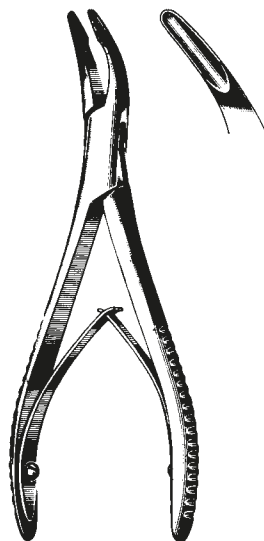

LUER
 33133-15
 15 cm, 5.9"

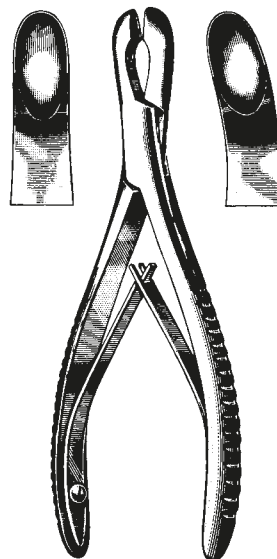

LUER
 33136-17 33137-17
 17 cm, 6 3/4"

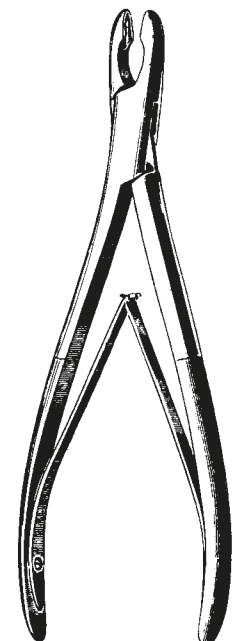

ADSON
 33142-20 33143-20
 20 cm, 7.9"

Hohlmeißelzangen
 Bone Rongeurs
 Pinzas-gubias
 Pinze sgorbie

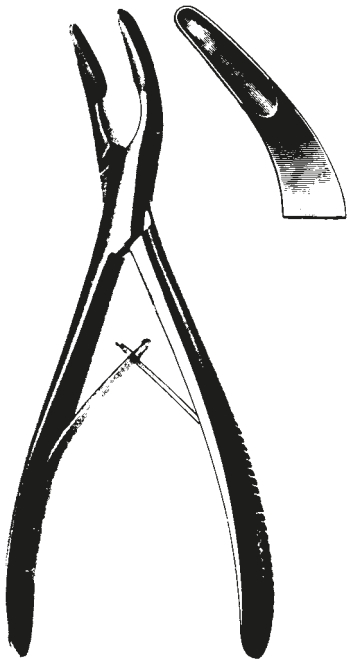

OLIVECRONA
 33147-20
 20 cm, 7.9"



BANE-HARTMANN
 33148-18
 17,5 cm, 7"

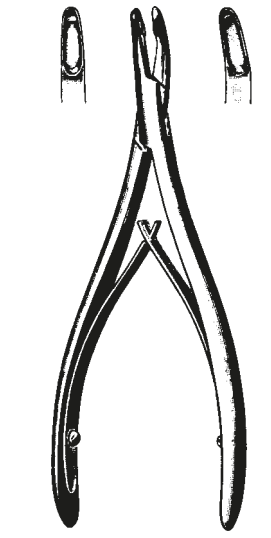

LEMPERT
 33150-16 33151-16
 16 cm, 6 1/4"



JANSEN
 17 cm, 6 3/4"

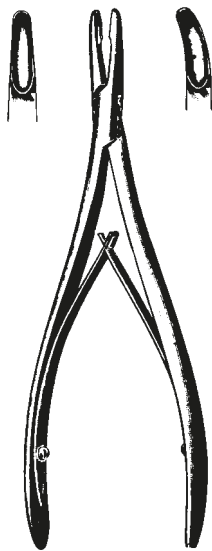

LEMPERT
 33154-18 33155-18
 18,5 cm, 7 1/4"



BEYER
 33156-18
 18 cm, 7"

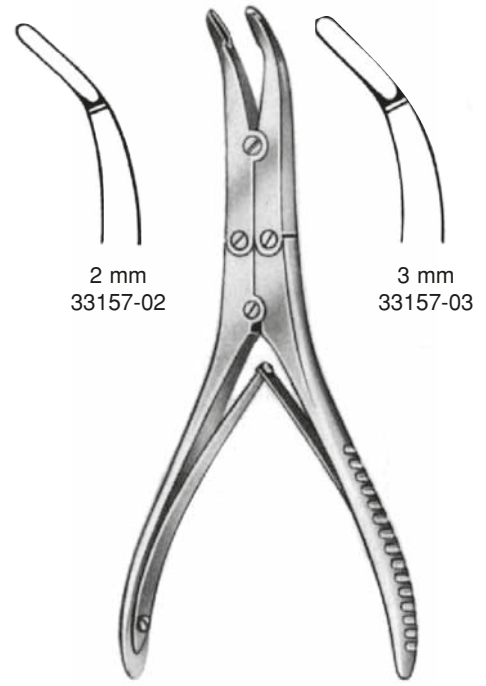

KLEINERT-KUTZ
 15 cm, 6"

Hohlmeißelzangen
 Bone Rongeurs
 Pinzas-gubias
 Pinze sgorbie



3 mm
33157-30



4 mm
33157-40



5 mm
33157-50



3 mm
33158-03



4 mm
33158-04



5 mm
33158-05



3 mm
33159-03



4 mm
33159-04



5 mm
33159-05



SMITH-PETERSEN

24 cm, 9 1/2"

33157-30 - 33157-50

33158-03 - 33158-05

33159-03 - 33159-05

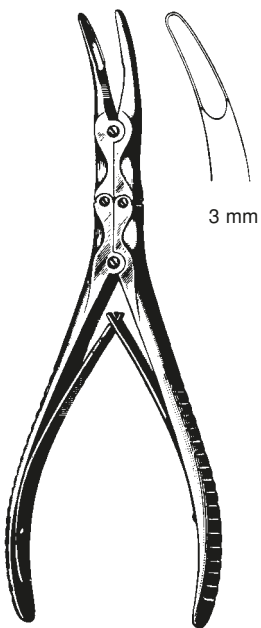

BEYER
33201-18
18 cm, 7"



MAYFIELD RONGEUR
33202-18
18 cm, 7"

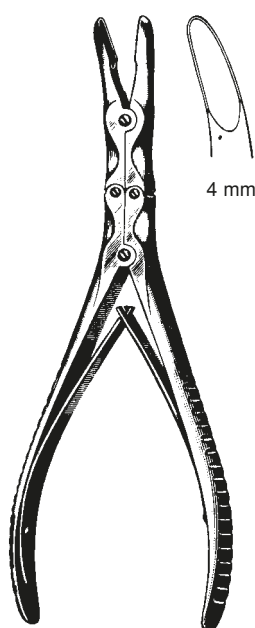

ZAUFAL-JANSEN
33205-18
18 cm, 7"

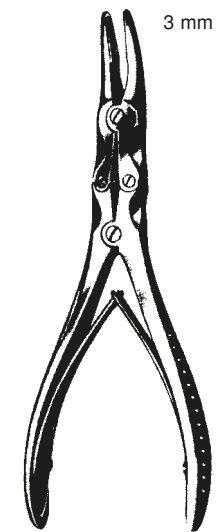

BÖHLER
33211-15 33213-15
15 cm, 6"

Hohlmeißelzangen
 Bone Rongeurs
 Pinzas-gubias
 Pinze sgorbie

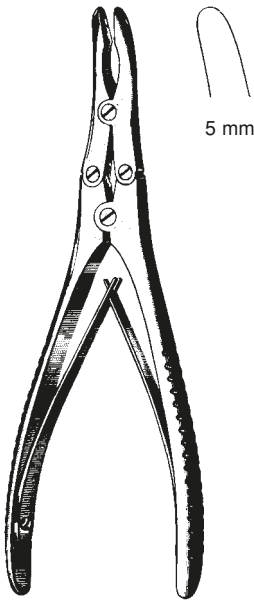

RUSKIN
 33216-18 33217-18
 18 cm, 7"

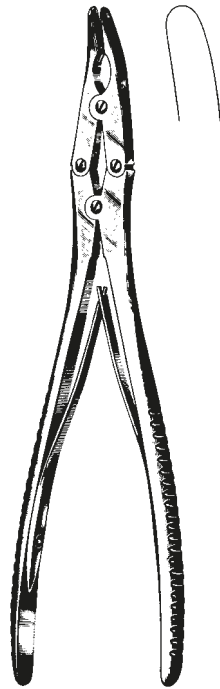

RUSKIN
 33219-23 23 cm, 9"



MARQUARDT
 33220-20 20 cm, 8"

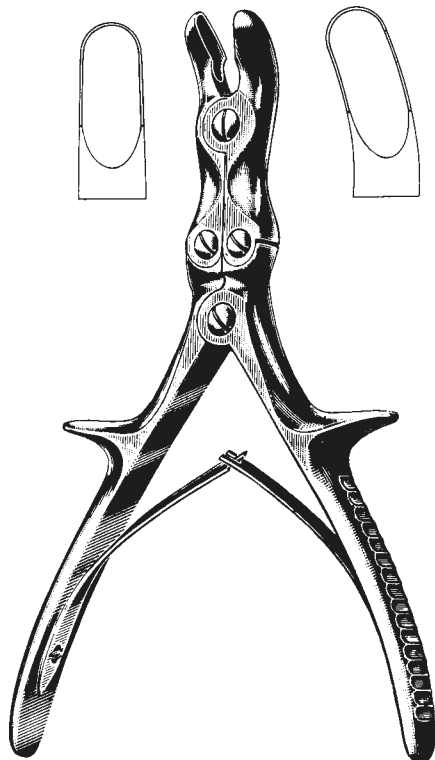

STILLE-LUER
 33230-22 22 cm, 8 3/4" 33231-22
 33230-26 26 cm, 10 1/4" 33231-26

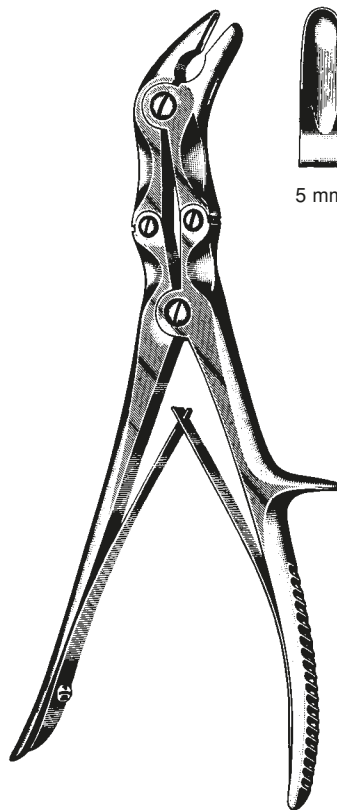

STILLE-LUER
 33235-23
 23 cm, 9"

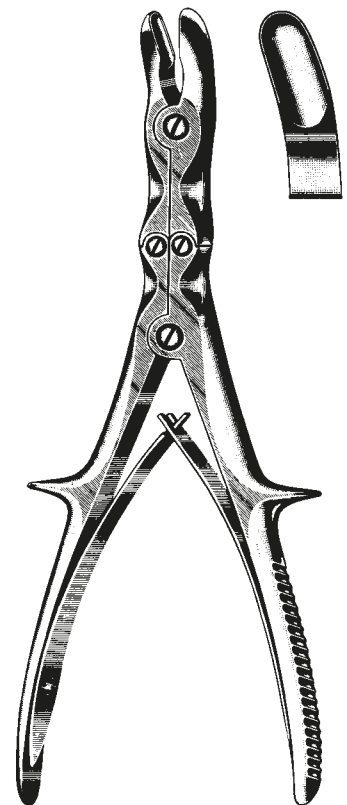

STILLE-RUSKIN
 33237-23
 23 cm, 9"

Hohlmeißelzangen
Bone Rongeurs
Pinzas-gubias
Pinze sgorbie

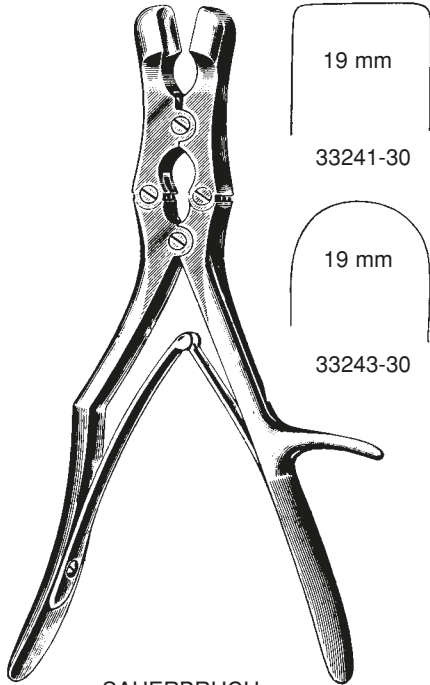

SAUERBRUCH
30 cm, 10 3/4"

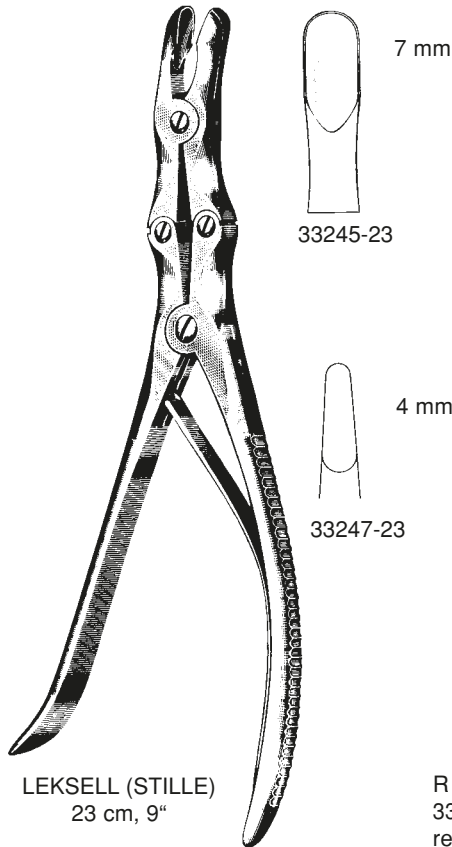

LEKSELL (STILLE)
23 cm, 9"

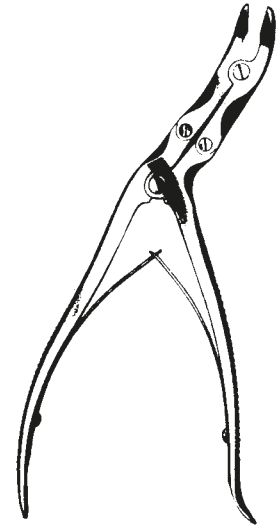

SCAGLIETTI
26 cm, 10 1/4"
R 33251-26 rechts right derecha a destra
L 33253-26 links left izquierda a sinistra



ECHLIN
33257-23 2 mm
33258-23 4 mm
33259-23 3 mm
23 cm, 9"



FRYKHOLM
33260-24
24 cm, 9 1/2"

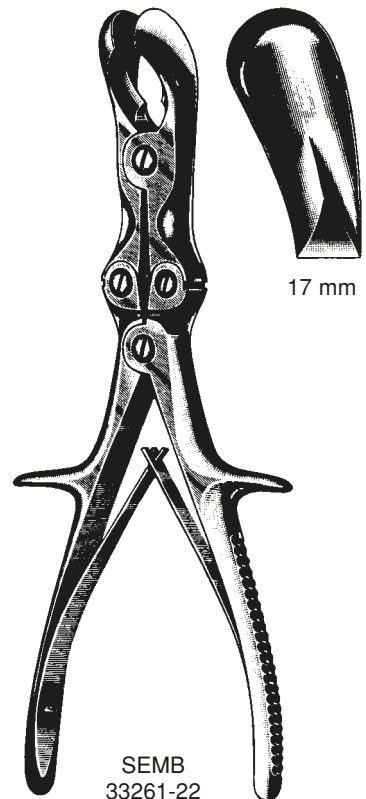

SEMB
33261-22
22,5 cm, 8.9"

Knochensplitterzangen
 Bone Cutting Forceps
 Pinzas contantes para huesos
 Cesoie per ossa

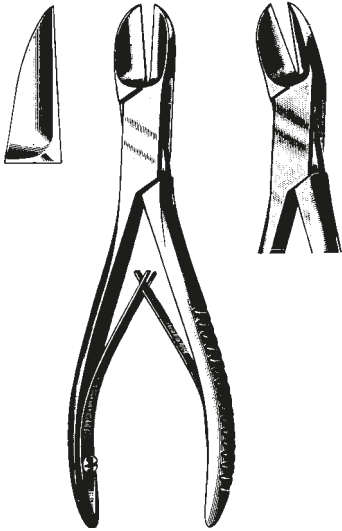

LISTON
 33274-14 14 cm, 5 1/2" 33275-14
 33274-17 17 cm, 6 3/4" 33275-17
 33274-19 19 cm, 7 1/2" 33275-19
 33274-22 22 cm, 8 3/4" 33275-22



BÖHLER
 33280-15 33281-15
 15 cm, 6"



COTTLE-KAZANJIAN
 33282-19
 19 cm, 7 1/2"



MC INDOE
 33283-17
 17 cm, 6 3/4"

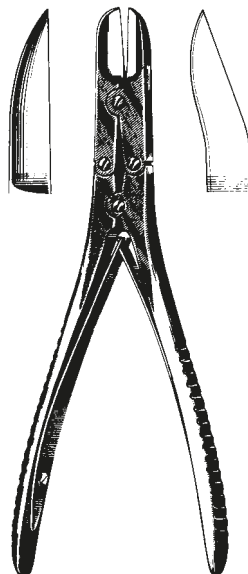

RUSKIN-LISTON
 33286-18 33289-18
 18 cm, 7"

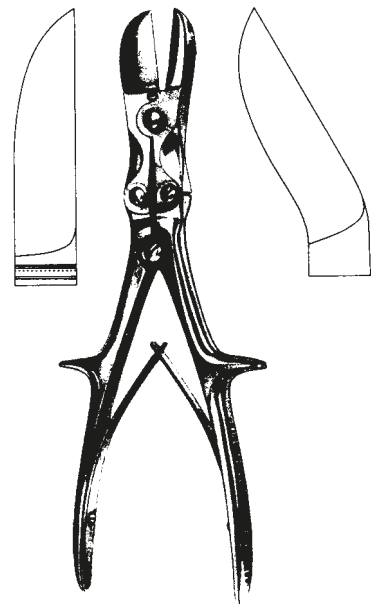

STILLE-LISTON
 33290-23 23 cm, 9" 33291-23
 33290-27 27 cm, 10 1/2" 33291-27

Knochensplitterzangen
Bone Cutting Forceps
Pinzas contantes para huesos
Cesioie per ossa



STILLE-LISTON
33292-26
26 cm, 10 1/4"

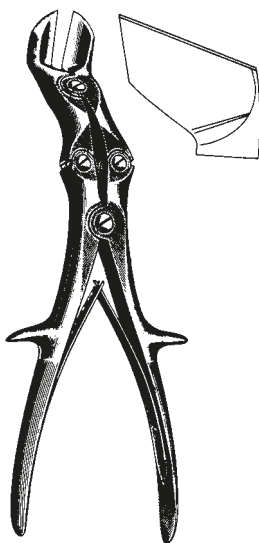

STILLE-HORSLEY
33293-27
27 cm, 10 1/2"

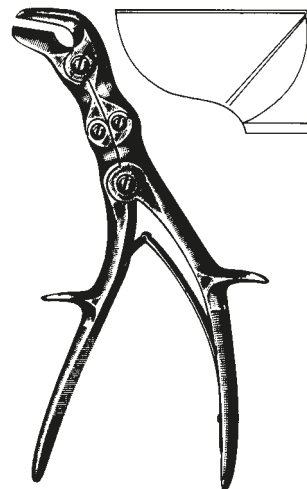

SEMB
33295-24
24 cm, 9 1/2"

Knochenhalte­zangen
Bone Holding Forceps
Pinzas para huesos
Tenaglie per ossa

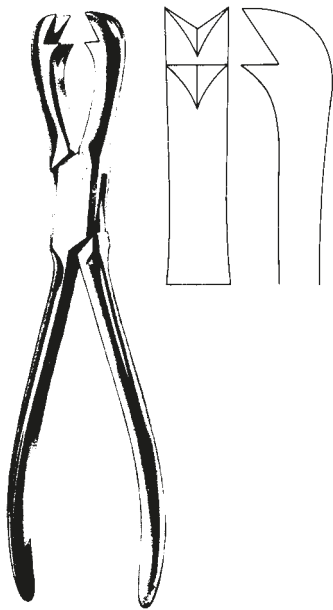

FERGUSSON
33360-21
21 cm, 8 1/4"

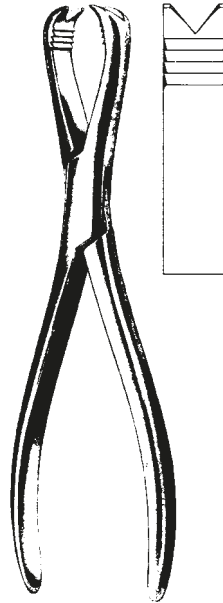

LANGENBECK
33362-21
21 cm, 8 1/4"

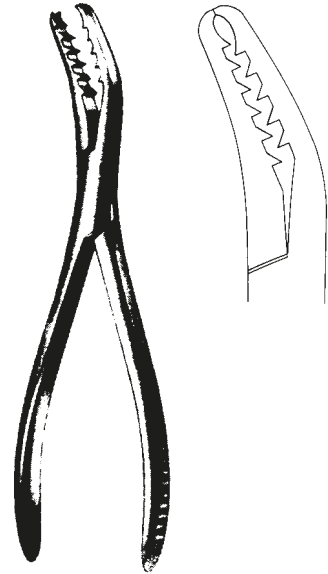

SEMB
33365-19
19 cm, 7 1/2"



SEMB
33366-19
19 cm, 7 1/2"



FARABEUF
33366-23 23 cm, 9"
33366-26 26 cm, 10 1/4"

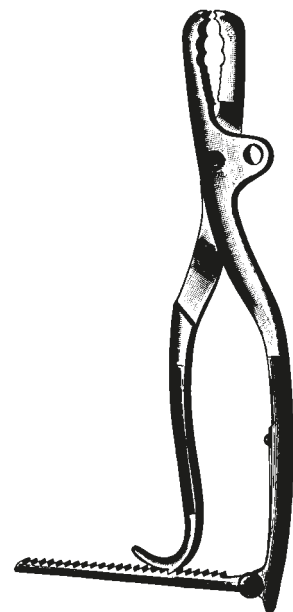

FARABEUF-LAMBOTTE
33368-26
26 cm, 10 1/4"

Knochenhalte­zangen
 Bone Holding Forceps
 Pinzas para huesos
 Tenaglie per ossa

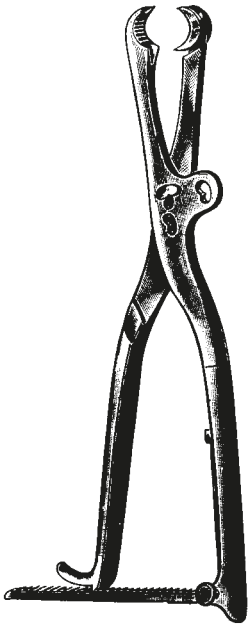

LAMBOTTE

33370-22 22 cm, 8 3/4"
 33370-27 27 cm, 10 1/2"
 33370-30 30 cm, 11 3/4"

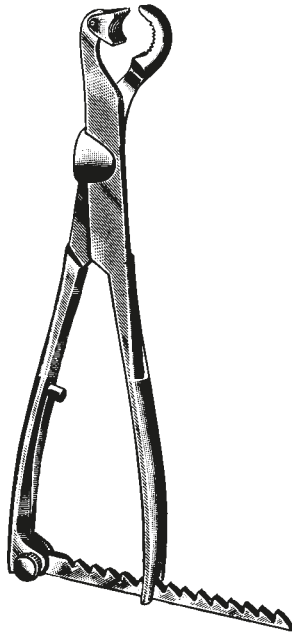

LAMBOTTE

33372-22 22 cm, 8 3/4"
 33372-26 26 cm, 10 1/4"
 33372-33 33 cm, 13"

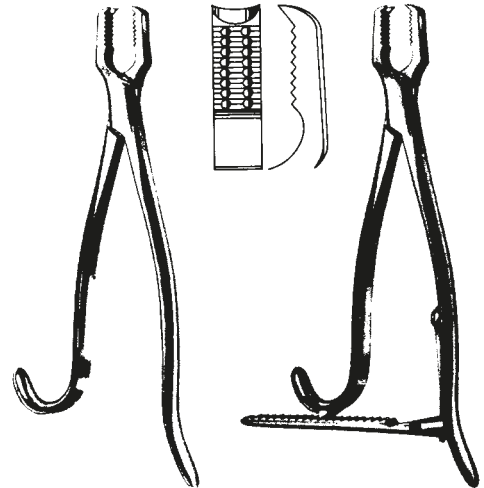

KERN

33378-15 15 cm, 6" 33380-15
 33378-17 17 cm, 6 3/4" 33380-17
 33378-21 21 cm, 8 1/4" 33380-21

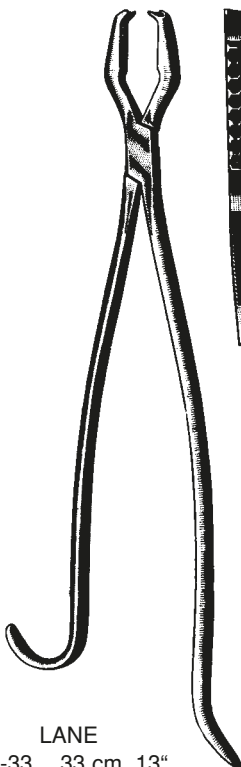

LANE

33382-33 33 cm, 13"
 33382-45 45 cm, 17 3/4"

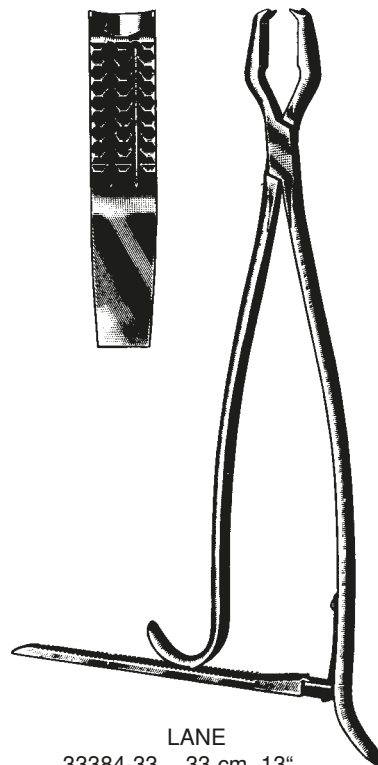

LANE

33384-33 33 cm, 13"
 33384-45 45 cm, 17 3/4"

Knochenhaltezangen
Bone Holding Forceps
Pinzas para huesos
Tenaglie per ossa

selbstzentrierend
self-centering
autocentrantes
autocentranti



33391-15
15 cm, 6"

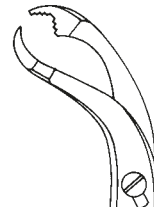

33391-19
19 cm, 7 1/2"

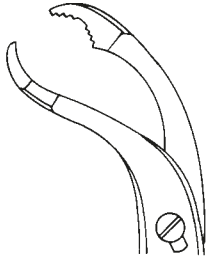

33391-24
24 cm, 9 1/2"

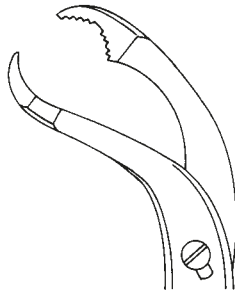

33391-26
26 cm, 10 1/4"

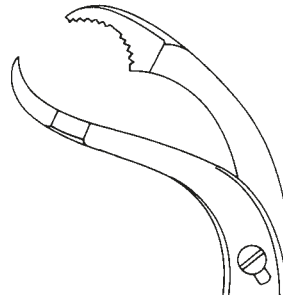

33391-28
28 cm, 11"

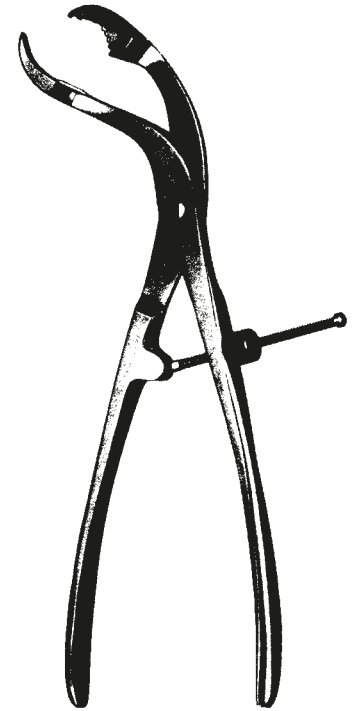

33391-15 - 33391-28

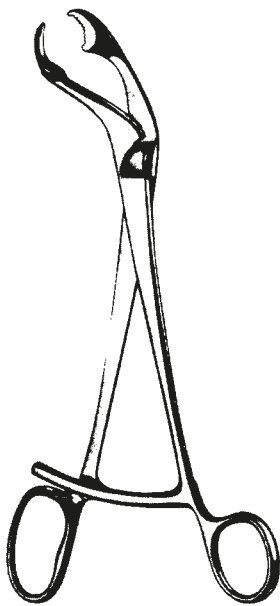

VERBRUGGE
33395-17 - 33395-27

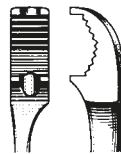

33395-17
17,5 cm, 7"

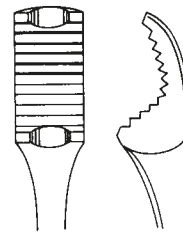

33395-25
25 cm, 10"

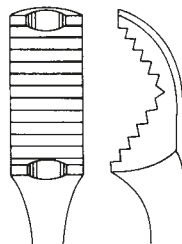

33395-26
26 cm, 10 1/4"

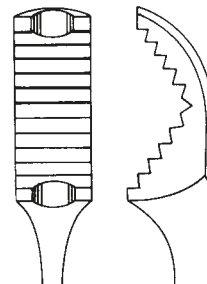

33395-27
27 cm, 10 1/2"

Knochenhaltezaugen
 Bone Holding Forceps
 Pinzas para huesos
 Tenaglie per ossa

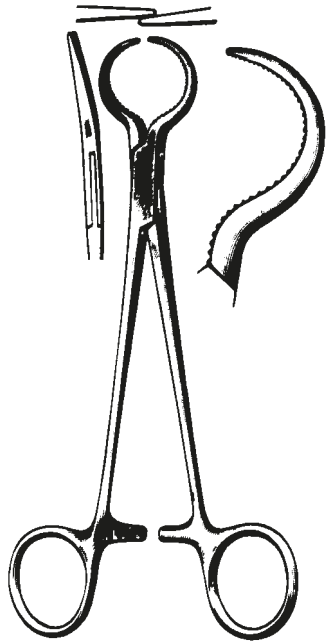

LEWIN
 33402-17
 17,5 cm, 7"

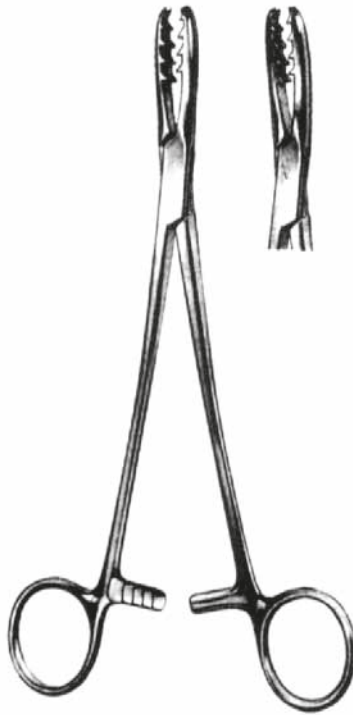

BIRCHER-GANSKE
 33404-20 33405-20
 20 cm, 8"



33406-20
 20 cm, 8"



DINGMANN
 33407-19
 19 cm, 7 1/2"

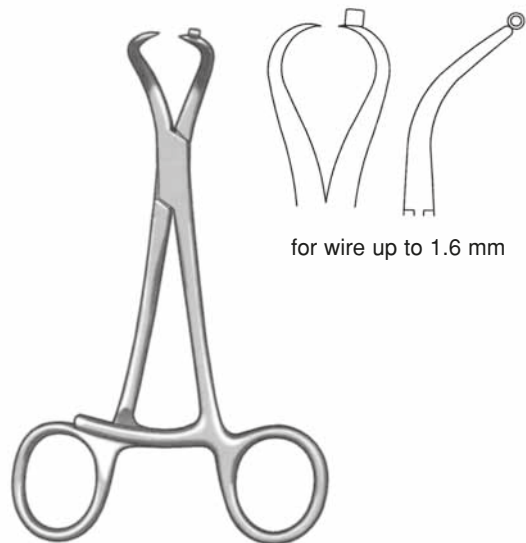

for wire up to 1.6 mm

33407-13
 13 cm, 5 1/8"

Knochenhaltezangen
 Bone Holding Forceps
 Pinzas para huesos
 Tenaglie per ossa



33410-13
 13,5 cm, 5 1/4"

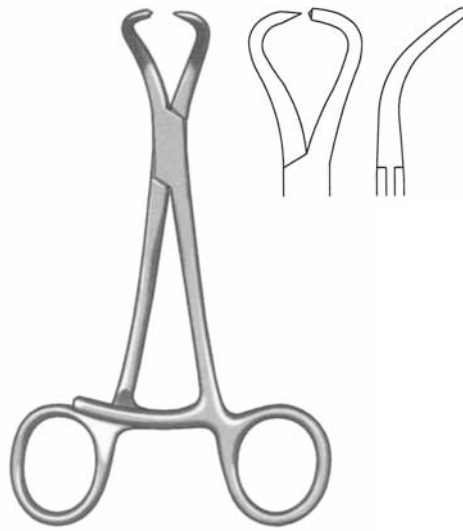

33408-13
 13 cm, 5 1/8"

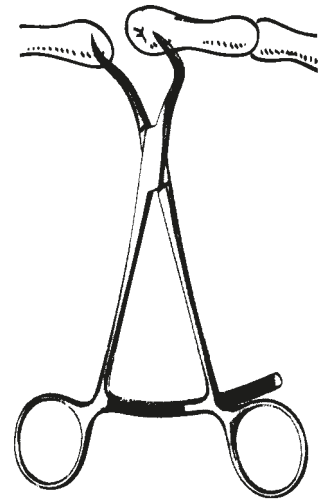

REDA
 33409-13
 13,5 cm, 5 1/4"

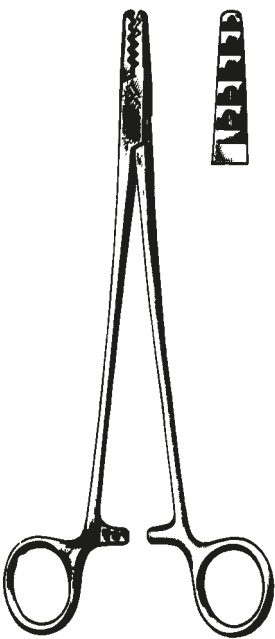

MARTIN
 33410-19
 19 cm, 7 1/2"



REDA
 33412-16 - 33412-24

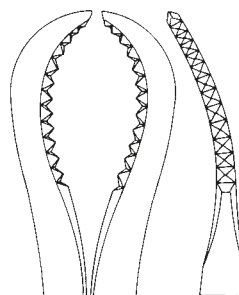

33412-16
 16 cm, 6 1/4"

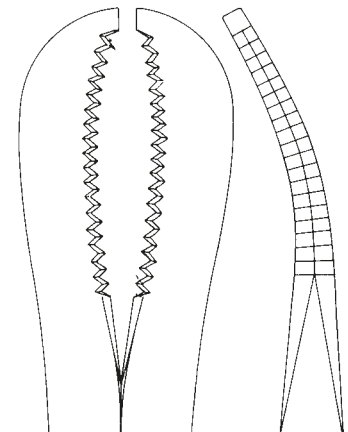

33412-24
 24 cm, 9 1/2"

Knochenhaltezangen
 Bone Holding Forceps
 Pinzas para huesos
 Tenaglie per ossa

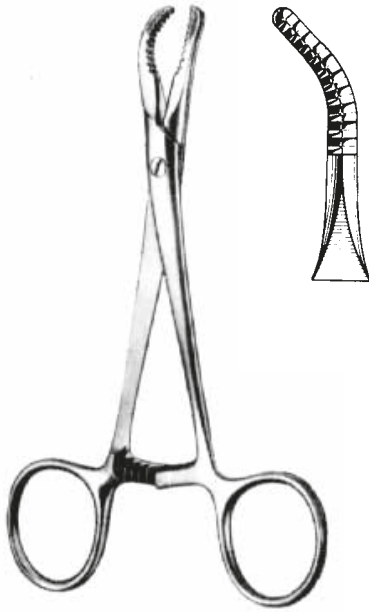

REDA
 33413-14
 13,5 cm, 5 1/4"



33414-21
 21 cm, 8 1/4"



ULRICH
 33415-23 - 33415-28

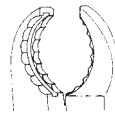
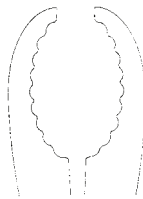

33415-23
 23 cm, 9"

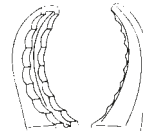

33415-25
 25 cm, 10"

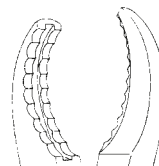

33415-28
 28 cm, 11"

Knochenhaltezangen
 Bone Holding Forceps
 Pinzas para huesos
 Tenaglie per ossa

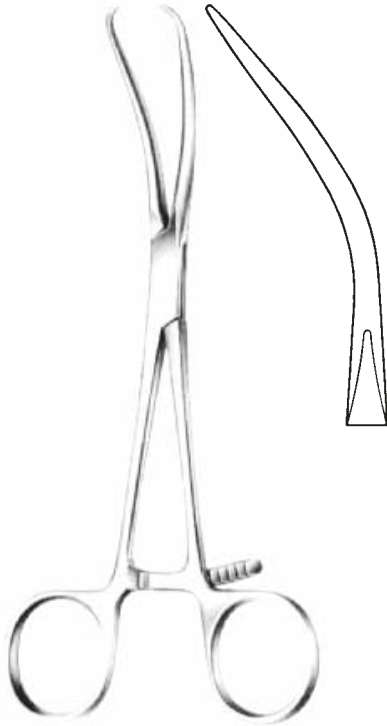

REILL
 33416-17
 17 cm, 6 3/4"



33417-18
 18,5 cm, 7 1/4"

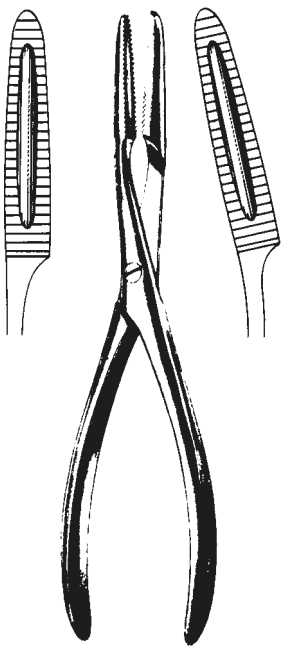

33420-20 33421-20
 20 cm, 8"

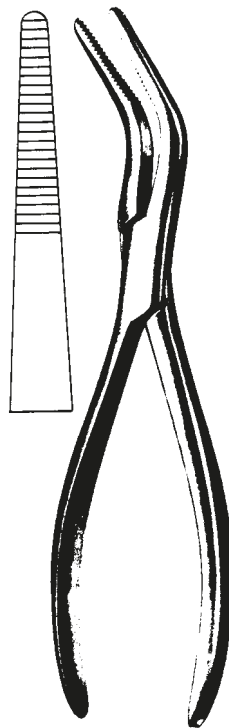

VAN BUREN
 33423-23
 23 cm, 9"



FELDHEIM
 33424-10
 10 cm, 4"

Knochenhalteclammern, -Klammern
 Bone holding forceps, -Clamps
 Pinzas para huesos, Clamps porta-huesos
 Tenaglie per ossa, Pinze per ossa



LOWMAN
 33441-13 13 cm, 5 1/8"
 33441-18 18 cm, 7"
 33441-20 20 cm, 8"



LOWMAN-HOGLUND
 33442-19
 19 cm, 7 1/2"

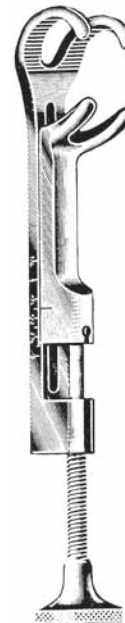

LAMBERT-LOWMAN
 33443-18
 18 cm, 7"

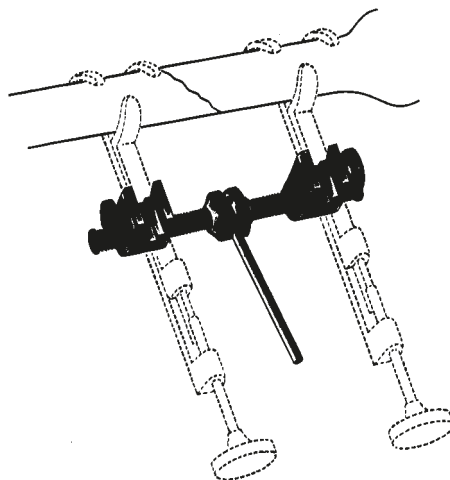

GERSTER
 33444-15

Knochenhaltezaugen, Bleihand
Bone holding forceps, Lead Hands
Pinzas para huesos, Manoplas de plomo
Tenaglie per ossa, Mani di piombo



33450-01
Erwachsen
adult size
p. adultos
p. adulti

33450-02
Kind
child size
p. niños
p. bambini

Scharfe Löffel
Bone Currettes
Cucharillas cortantes
Curette taglienti

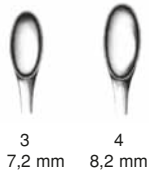
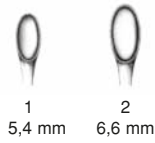
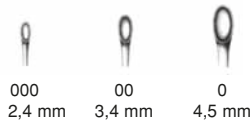

SCHEDE	Fig.	VOLKMANN
	0000	33469-96
33467-97	000	33469-97
33467-98	00	33469-98
33468-00	0	33470-00
33468-01	1	33470-01
33468-02	2	33470-02
33468-03	3	33470-03
33468-04	4	33470-04
	5	33470-05
	6	33470-06

SCHEDE
17 cm, 6 3/4"
33467-97 - 33468-04

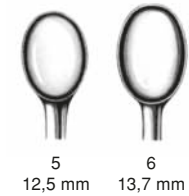
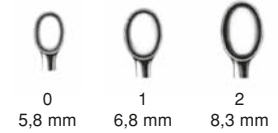

VOLKMANN
17 cm, 6 3/4"
33469-96 - 33470-06

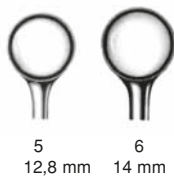
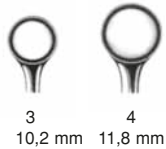

BRUNS	Fig.	SPRATT
33471-96	0000	
33471-97	000	33474-97
33471-98	00	33474-98
33472-00	0	33475-00
33472-01	1	33475-01
33472-02	2	33475-02
33472-03	3	33475-03
33472-04	4	33475-04
33472-05	5	33475-05
33472-06	6	33475-06

BRUNS
17 cm, 6 3/4"
33471-96 - 33472-06



SPRATT
17 cm, 6 3/4"
33474-97 - 33475-06

Scharfe Löffel
Bone Curettes
Cucharillas cortantes
Curette taglienti

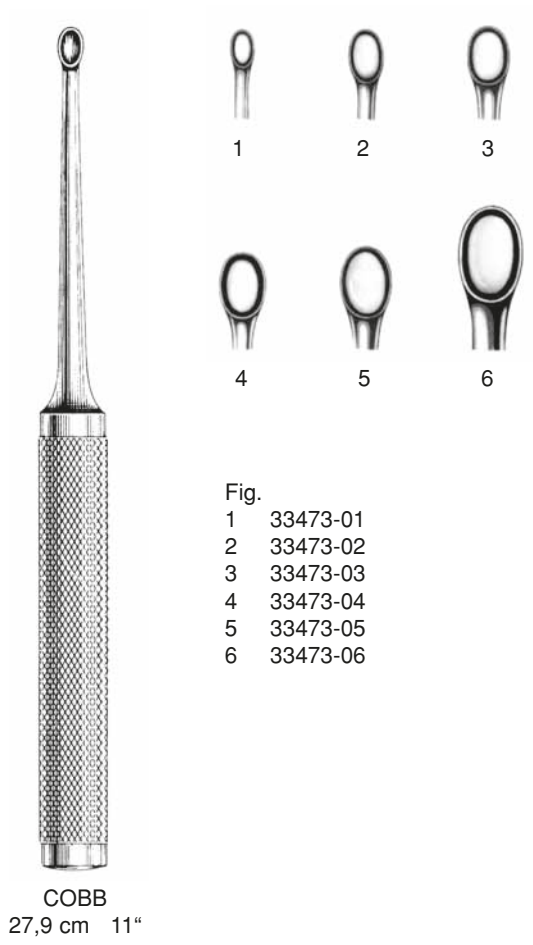

Scharfe Löffel
Bone Currettes
Cucharillas cortantes
Curette taglianti

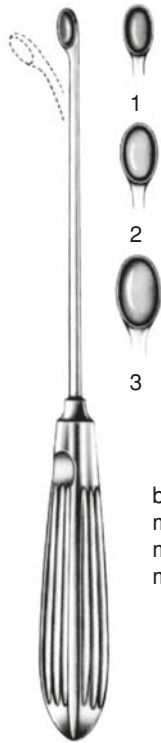

Fig.		
1	33476-01	4,8 mm
2	33476-02	5,8 mm
3	33476-03	6,8 mm

biegsam
malleable
maleable
malleabile

HALLE
21 cm, 8 1/4"
33476-01 - 33476-02



Fig.		
000	33476-98	2,8 mm
00	33476-99	3,3 mm
0	33477-00	3,7 mm
1	33477-01	4,3 mm
2	33477-02	4,8 mm
3	33477-03	5,6 mm
4	33477-04	6,1 mm
5	33477-05	6,7 mm
6	33477-06	8,8 mm

SPINAL
20 cm, 8"
33476-98 - 33477-06

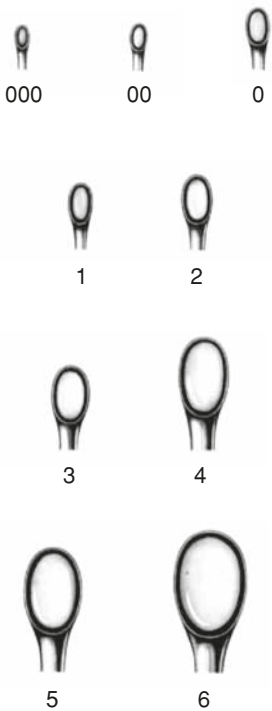

Fig.		
000	33478-98	2,8 mm
00	33478-99	3,3 mm
0	33479-00	3,7 mm
1	33479-01	4,3 mm
2	33479-02	4,8 mm
3	33479-03	5,6 mm
4	33479-04	6,1 mm
5	33479-05	6,7 mm
6	33479-06	8,8 mm

SPINAL
20 cm, 8"
33478-98 - 33479-06



SCOVILLE
25 cm, 10"
33482-01 - 33482-03

Scharfe Löffel
Bone Currettes
Cucharillas cortantes
Curette taglienti

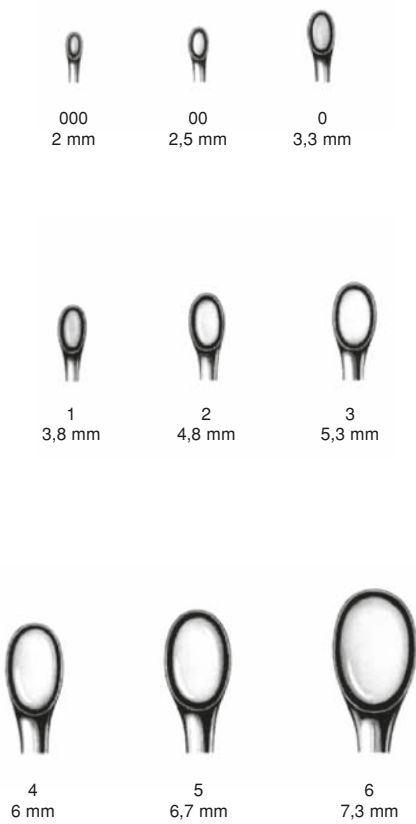

BRUNS
23 cm, 9"



BRUNS
23 cm, 9"



BRUNS
23 cm, 9"

Fig.	33480-97	33482-97	33484-97
000	33480-97	33482-97 2,8 mm	33484-97 2,8 mm
00	33480-98	33482-98 3,3 mm	33484-98 3,3 mm
0	33481-00	33483-00 3,7 mm	33485-00 3,7 mm
1	33481-01	33483-01 4,3 mm	33485-01 4,3 mm
2	33481-02	33483-02 4,8 mm	33485-02 4,8 mm
3	33481-03	33483-03 5,6 mm	33485-03 5,6 mm
4	33481-04	33483-04 6,1 mm	33485-04 6,1 mm
5	33481-05	33483-05 6,7 mm	33485-05 6,7 mm
6	33481-06	33483-06 8,8 mm	33485-06 8,8 mm

Scharfe Löffel
 Bone Currettes
 Cucharillas cortantes
 Curette taglienti



33485-21 21 cm, 8 1/4"
 oval/rund
 ovale/ronde
 avalado/redondo
 ovale/rotonda



WILLIGER
 17,5 cm
 7"

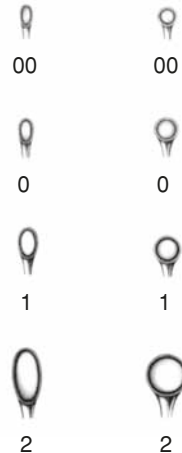
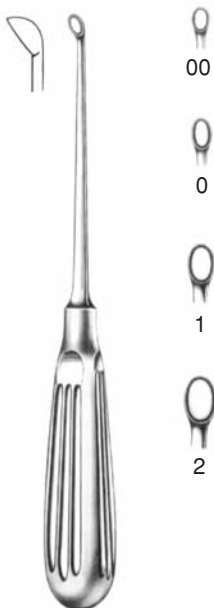

Fig. 00	33485-99	33486-99
0	33486-00	33487-00
1	33486-01	33487-01
2	33486-02	33487-02



DAUBENSPECK	Fig. 00	33487-99
20 cm, 8"	0	33488-00
	1	33488-01
	2	33488-02



27 cm	Fig. 0	33489-00
10 1/2"	1	33489-01
	2	33489-02
	3	33489-03

Scharfe Löffel
Bone Curettes
Cucharillas cortantes
Curette taglienti



33489-09
Löffel Kürette, klein 9 mm
28 cm, 11"



33489-15
Löffel Kürette, mittel 15 mm
28 cm, 11"



33489-27
Löffel Kürette, groß 27 mm
28 cm, 11"

Scharfe Löffel
 Bone Currettes
 Cucharillas cortantes
 Curette taglianti



LEMPERT
 17,5 cm, 7"



Fig. 0	33490-10	3,3 mm
00	33490-20	3,0 mm
000	33490-30	2,7 mm
0000	33490-40	2,4 mm
00000	33490-50	2,0 mm



REDA
 25 cm, 10"

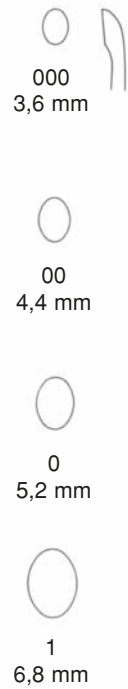

Fig. 000	33491-01
00	33491-02
0	33491-03
1	33491-04

Scharfe Löffel
 Bone Currettes
 Cucharillas cortantes
 Curette taglienti



REDA
 25 cm, 10"

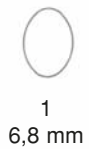
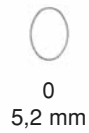

Fig.	000	33491-05
	00	33491-06
	0	33491-07
	1	33491-08



BUSHE
 25 cm, 10"



Fig.	000	33500-01
	00	33500-02
	0	33500-03

Scharfe Löffel
 Bone Currettes
 Cucharillas cortantes
 Curette taglienti



VOLKMANN
 33492-13 13 cm, 5 1/8"
 33492-16 16 cm, 6 1/4"
 33492-20 20 cm, 8"



VOLKMANN
 33494-13 13 cm, 5 1/8"
 33494-14 14 cm, 5 1/2"
 33494-17 17 cm, 6 3/4"



JANSEN
 33495-16
 16 cm, 6 1/4"

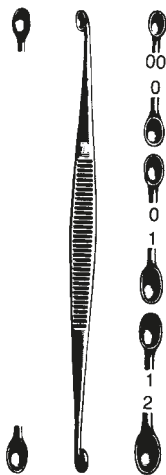

WILLIGER
 13,5 cm, 5 1/4" Fig.
 33496-00 00/0
 33496-01 0/1
 33496-12 1/2

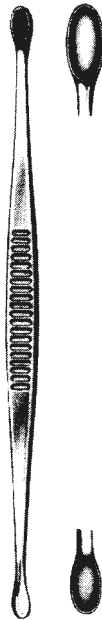

JACOBSON
 13 cm, 5 1/8"
 33497-00

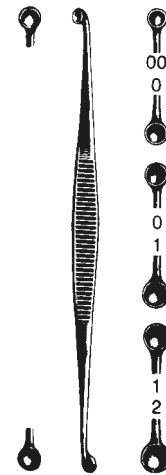



MARTINI
 13,5 cm, 5 1/4"
 33498-00
 33498-01
 33498-12

Stößel
Hemostats
Hemostáticos
Pistoni



CASPAR
200 mm, 8"

-  33509-03
Ø 3 mm
-  33509-05
Ø 5 mm
-  33509-08
Ø 8 mm





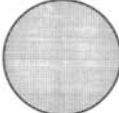
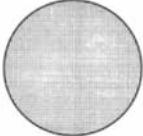
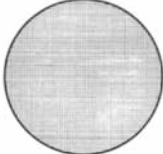





200 mm, 8"

-  33510-12
Ø 12 mm
-  33510-14
Ø 14 mm
-  33510-16
Ø 16 mm



16 cm, 6 1/4"

- | | |
|--------------------------------------------------------------------------------------------|---------------------------------------------------------------------------------------------|
|  2 mm |  6 mm |
|  3 mm |  8 mm |
|  4 mm |  9 mm |
|  5 mm |  10 mm |
-
- | | |
|-------|----------|
| 2 mm | 33600-02 |
| 3 mm | 33600-03 |
| 4 mm | 33600-04 |
| 5 mm | 33600-05 |
| 6 mm | 33600-06 |
| 8 mm | 33600-08 |
| 9 mm | 33600-09 |
| 10 mm | 33600-10 |

Stößel, Flachmeißel, Hohlmeißel
 Hemostats, Chisels, Gouges
 Hemostáticos, Cinceles, Gubias
 Pistoni, scalpelli, sgorbie



13,5 cm, 5 1/4"

13,5 cm, 5 1/4"

13,5 cm, 5 1/4"

ALEXANDER
 17 cm, 6 3/4"

ALEXANDER
 17 cm, 6 3/4"

4 mm	33602-04
6 mm	33602-06
8 mm	33602-08
10 mm	33602-10
12 mm	33602-12
14 mm	33602-14
16 mm	33602-16

33604-04
33604-06
33604-08
33604-10
33604-12
33604-14
33604-16

33605-04
33605-06
33605-08
33605-10
33605-12
33605-14
33605-16

33610-04	4 mm
33610-06	6 mm
33610-08	8 mm
33610-10	10 mm
33610-12	12 mm
33610-14	14 mm

33611-04	4 mm
33611-06	6 mm
33611-08	8 mm
33611-10	10 mm
33611-12	12 mm
33611-14	14 mm



Meißel gerade
 3 mm
 33613-03
 31 cm, 12 1/4"

Meißel gerade
 7,5 mm
 33615-07
 31 cm, 12 1/4"

PARTSCH

13,5 cm, 5 1/4"	mm	17 cm, 6 3/4"
33620-02	2	33622-02
33620-03	3	33622-03
33620-04	4	33622-04
33620-05	5	33622-05
33620-06	6	33622-06
33620-07	7	33622-07
33620-08	8	33622-08

PARTSCH

13,5 cm, 5 1/4"	mm	17 cm, 6 3/4"
33623-02	2	33625-02
33623-03	3	33625-03
33623-04	4	33625-04
33623-05	5	33625-05
33623-06	6	33625-06
33623-07	7	33625-07
33623-08	8	33625-08

Flachmeißel, Hohlmeißel
Chisels, Gouges
Cinceles, Gubias
Scalpelli, sgorbie

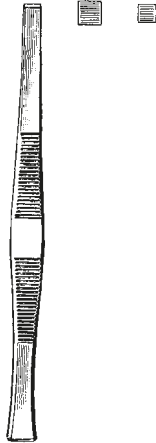

PASSOW
12 cm, 4 3/4"

33626-35 3,5 mm
33626-25 2,5 mm



STILLE
20 cm, 8"

6 mm 33630-06
8 mm 33630-08
10 mm 33630-10
12 mm 33630-12
15 mm 33630-15
20 mm 33630-20
25 mm 33630-25
30 mm 33630-30



STILLE
20 cm, 8"

33631-10
33631-12
33631-15
33631-20
33631-25
33631-30



STILLE
20 cm, 8"

6 mm 33632-06
8 mm 33632-08
10 mm 33632-10
12 mm 33632-12
15 mm 33632-15
20 mm 33632-20
25 mm 33632-25
30 mm 33632-30



STILLE
20 cm, 8"

33633-06
33633-08
33633-10
33633-12
33633-15
33633-20
33633-25
33633-30



STILLE
20 cm, 8"

33634-06
33634-08
33634-10
33634-12
33634-15
33634-20
33634-25
33634-30

Osteotome, Hohlmeißel
 Chisels, Gouges
 Cinceles, Gubias
 Scalpelli, sgorbie

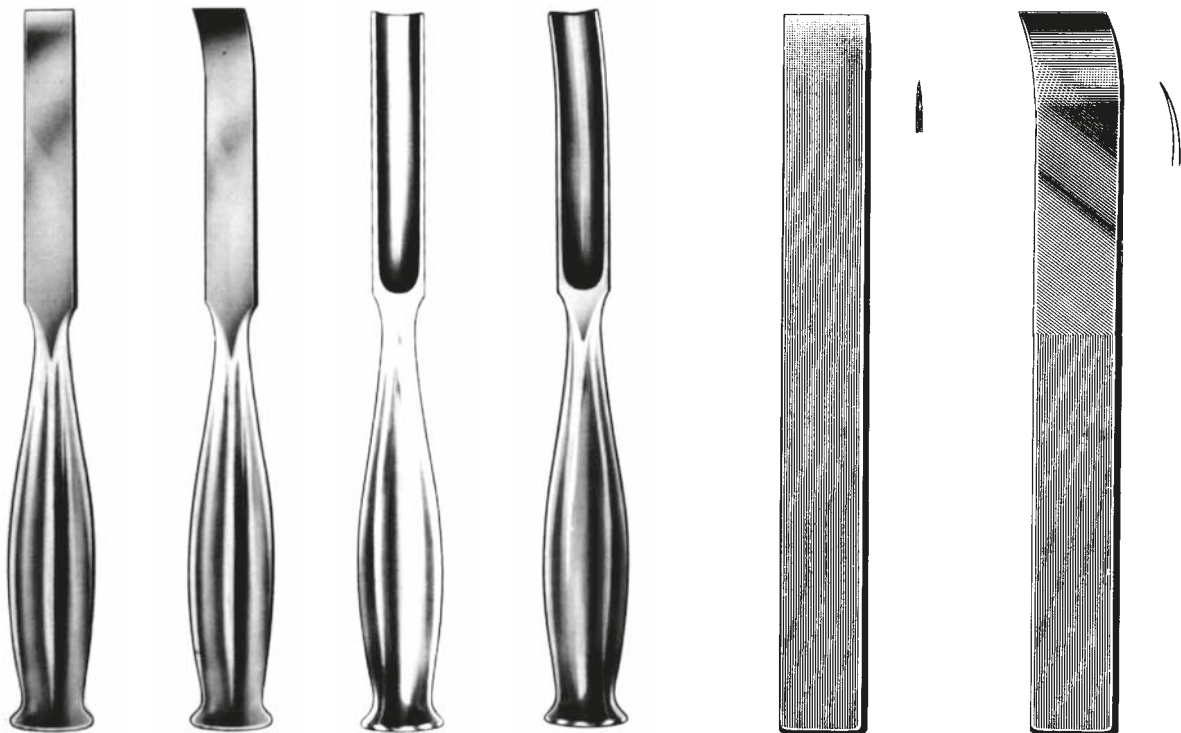

SMITH-PETERSEN
 20 cm, 8"

LAMBOTTE
 24 cm, 9 1/2" 23 cm, 9"

6 mm	33644-06	33645-06	33647-06	
9 mm	33644-09	33645-09	33647-09	33649-09
13 mm	33644-13	33645-13		
14 mm			33647-14	33649-14
16 mm	33644-16	33645-16	33647-16	33649-16
19 mm	33644-19	33645-19	33647-19	33649-19
25 mm	33644-25	33645-25	33647-25	33649-25
32 mm	33644-32	33645-32	33647-32	33649-32

33650-04	4 mm	33651-04
33650-06	6 mm	33651-06
33650-08	8 mm	33651-08
33650-10	10 mm	33651-10
33650-13	13 mm	33651-13
33650-16	16 mm	33651-16
33650-18	18 mm	33651-18
33650-20	20 mm	33651-20
33650-25	25 mm	33651-25
33650-30	30 mm	33651-30
33650-38	38 mm	33651-38
33650-44	44 mm	33651-44
33650-50	50 mm	33651-50

Osteotome, Hohlmeißel
Chisels, Gouges
Cinceles, Gubias
ScalPELLI, sgorbie

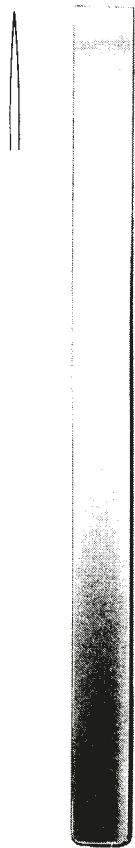

MINI-LAMBOTTE

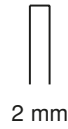

2 mm



3 mm



4 mm

12,5 cm, 5"

33654-02

33654-03

33654-04

33654-06

33654-08

33654-10

33654-12

33654-15

mm

17 cm, 6 3/4"

2 33652-02

3 33652-03

4 33652-04

6 33652-06

8 33652-08

10 33652-10

12 33652-12

15 33652-15



6 mm



8 mm



10 mm



12 mm



15 mm

Hohlmeißel mit Ferrozellgriff
Gouges with Ferrozell-Handle
Gubias con mango de Ferrozell
Sgorbie con manico di Ferrozell

8 mm



COBB
28 cm, 11"
33656-28

8 mm



COBB
28 cm, 11"
33657-28

8 mm



COBB
28 cm, 11"
33658-28

8 mm



COBB
28 cm, 11"
33659-28

Osteotome, Hohlmeißel mit Ferrozell-Griff
 Chisels and Gouges with Ferrozell-Handle
 Gubias con mango de Ferrozell
 Osteotomo, con manico di Ferrozell

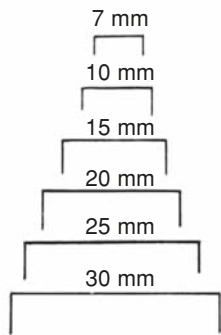

33660-07	7 mm	33661-07
33660-10	10 mm	33661-10
33660-15	15 mm	33661-15
33660-20	20 mm	33661-20
33660-25	25 mm	33661-25
33660-30	30 mm	33661-30

LEXER
 22 cm, 8 3/4"

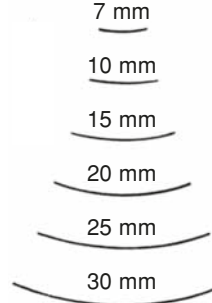

LEXER
 22 cm, 8 3/4"

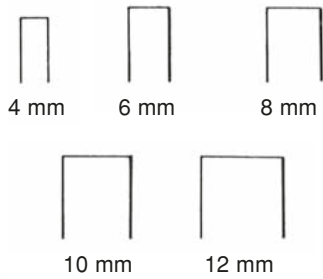

33664-04	4 mm	33665-04
33664-06	6 mm	33665-06
33664-08	8 mm	33665-08
33664-10	10 mm	33665-10
33664-12	12 mm	33665-12

LEXER MINI
 18 cm, 7"

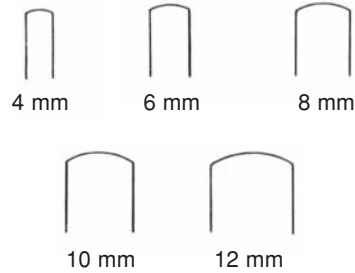

LEXER MINI
 18 cm, 7"

Flachmeißel
Chisels
Cinceles
Scalpelli



20 mm

33665-24
24,5 cm, 9 3/4"



16 mm

33665-26
26,5 cm, 10 1/2"

Hohlmeißel mit NOVOTEX-Griff
Gouges with Novotex-Handle
Gubias con mango de Novotex
Sgorbie con manico di Novotex



ZIELKE 23 cm, 9"
33665-55 5,5 mm
33665-90 9,0 mm



9 mm

22 cm, 8 3/4"
33666-22

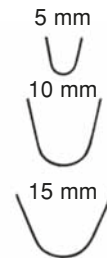

25 cm, 10"

33669-05	5 mm	33670-05
33669-10	10 mm	33670-10
33669-15	15 mm	33670-15

Flachmeißel, Hohlmeißel
 Chisels, Gouges
 Cinceles, Gubias
 Scalpelli, Sgorbie



HOKE
 14 cm, 5 1/2"
 33668-03 3 mm
 33668-05 5 mm
 33668-06 6 mm
 33668-08 8 mm
 33668-09 9 mm
 33668-10 10 mm
 33668-13 13 mm



HIBBS
 24 cm, 9 1/2"
 33670-06 6 mm
 33670-09 9 mm
 33670-13 13 mm
 33670-16 16 mm
 33670-19 19 mm
 33670-25 25 mm
 33670-32 32 mm



HIBBS
 24 cm, 9 1/2"
 33671-06 6 mm
 33671-09 9 mm
 33671-13 13 mm
 33671-16 16 mm
 33671-19 19 mm
 33671-25 25 mm
 33671-32 32 mm



HIBBS
 24 cm, 9 1/2"
 33672-06 6 mm
 33672-09 9 mm
 33672-13 13 mm
 33672-16 16 mm
 33672-19 19 mm
 33672-25 25 mm
 33672-32 32 mm



HIBBS
 24 cm, 9 1/2"
 33673-06 6 mm
 33673-09 9 mm
 33673-13 13 mm
 33673-16 16 mm
 33673-19 19 mm
 33673-25 25 mm
 33673-32 32 mm



HIBBS
 24 cm, 9 1/2"
 33675-06 6 mm
 33675-09 9 mm
 33675-13 13 mm
 33675-16 16 mm
 33675-19 19 mm
 33675-25 25 mm
 33675-32 32 mm

Meißel
Chisels
Cinceles
Scalpelli

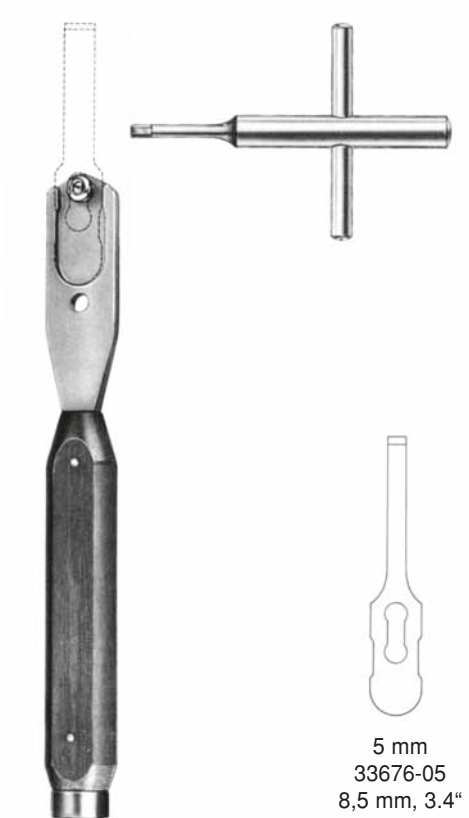

33676-02
9 cm, 3 1/2"
Spannschlüssel
Key
Llave
Clé
Chiave

33676-01
18,5 cm, 7 1/4"
Griff allein
Handle only
Mango suelto
Manico solo

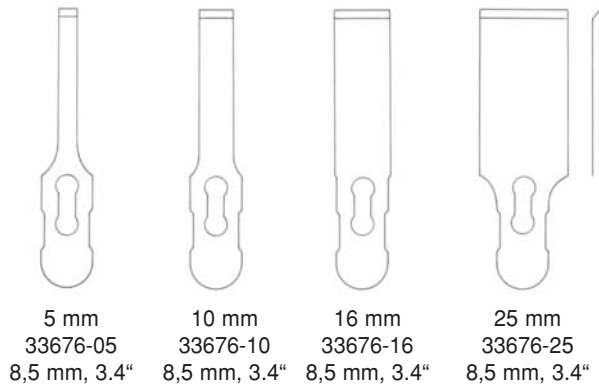

Meißelklingen
auswechselbar
Chisel blades
interchangeable
Hojas de cincel
intercambiables
Lame intercambiabili

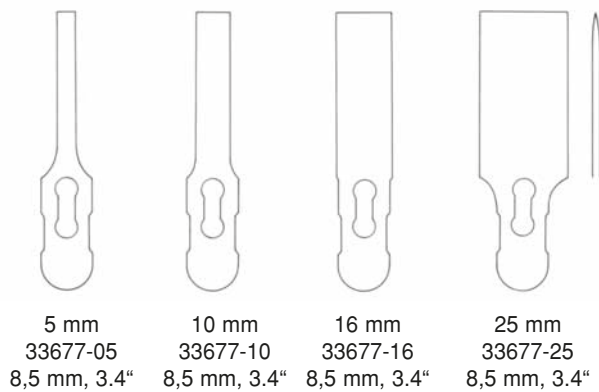

Osteotomklingen
auswechselbar
Osteotome blades
interchangeable
Hojas de osteótomo
intercambiables
Lame per osteotomia
intercambiabili

Hämmer
Bone Hammers and Mallets
Martillos y mazos
Martelli

Ø 25 mm



GERZOG
18 cm, 7"
33686-25 250 g

Ø 38 mm

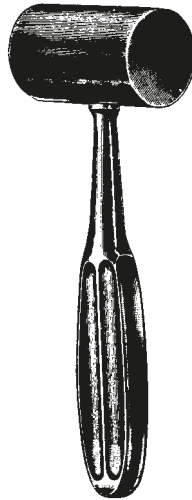

KIRK
19 cm, 7 1/2"
33687-75 750 g

Head Ø 35 mm / 450 g



26,5 cm, 10 1/2"
33688-45

Head Ø 32 mm / 450 g



27,5 cm, 10 3/4"
33689-45 900 g

Head Ø 38 mm / 600 g

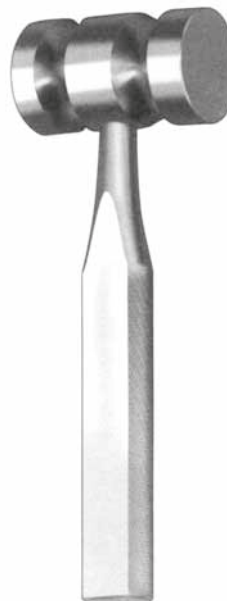

25 cm, 10"
33689-90 900 g

Hämmer
Bone Hammers and Mallets
Martillos y mazos
Martelli

Ø 30 mm

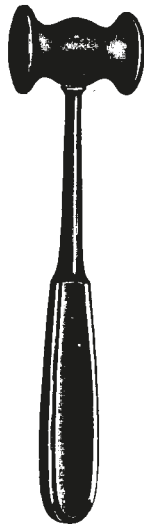

COLLIN
20 cm, 8"
33690-22 220 g



Head Ø 26 mm / 150 g
33694-15
Head Ø 30 mm / 240 g
33694-24
19 cm, 7 1/2"

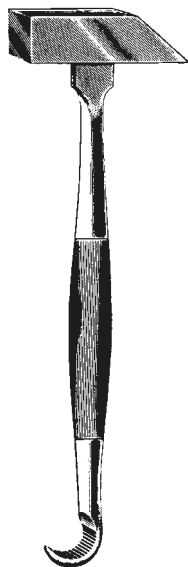

33699-00
23,5 cm, 9 1/4"
480 g

Ø 25 mm



33694-01
33694-03 Ersatzbacken
Nylon Caps
Tapas de repuesto
Placche di ricambio

Hämmer
Bone Hammers and Mallets
Martillos y mazos
Martelli

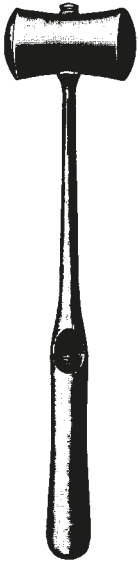

WILLIGER
24 cm, 9 1/2"
33691-34 340 g

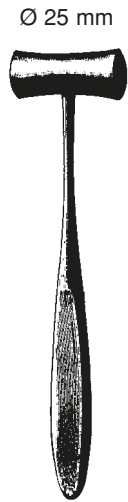

LUCAE
19 cm, 7 1/2"
33692-26 260 g

massiv, mit auswechselbaren Ferrozellbacken
solid, with interchangeable Ferrozell jaws
macizo, con tapas intercambiables de Ferrozell
solido, con placche intercambiabili in Ferrozell



33693-33
Paar Ersatzbacken
Pair spare jaws
par de tapas de repuesto
Coppia di placche di ricambio

33693-34
Satz Ringe
Set rings
juego de anillos
Set anelli

MEAD
17 cm, 6 3/4"
33693-32 320 g

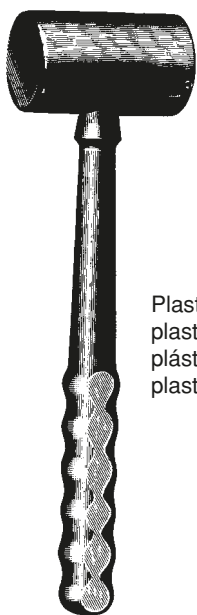

Plastik
plastic
plástico
plastica

26 cm, 10 1/4"
33695-40 400 g



QUISLING
33696-75



PARTSCH
33698-98
18 cm, 7"
199 g



33699-17
26,5 cm, 10 1/2"

Hämmer
Bone Hammers and Mallets
Martillos y mazos
Martelli



33700-01-01
Ersatzbacken
Nylon Caps
Tapas de repuesto
Placche di ricambio

24,5 cm, 9 3/4" 215 g
33700-01

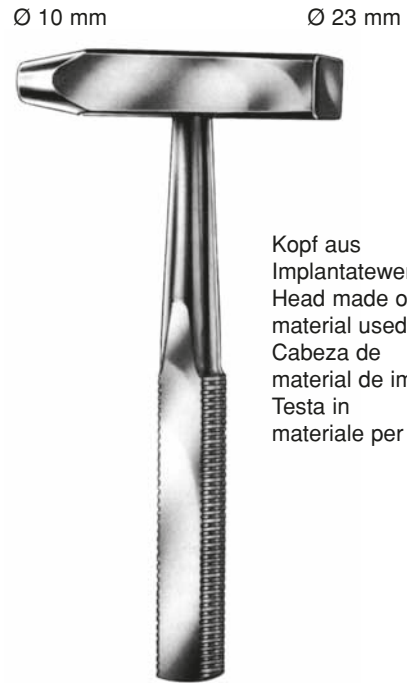

Kopf aus
Implantatwerkstoff
Head made of
material used for implants
Cabeza de
material de implantación
Testa in
materiale per impianti

23 cm, 9" 350 g
33700-02



BERGMANN
24 cm, 9 1/2" 300 g
33700-03

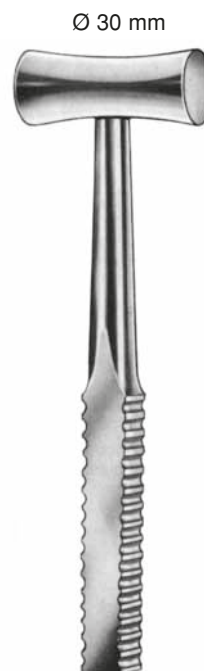

BERGMANN
23 cm, 9" 300 g
33700-04

Hämmer
Bone Hammers and Mallets
Martillos y mazos
Martelli



COTTLE
18 cm, 7" 240 g
33700-05



HEATH
18 cm, 7" 700 g
33700-06



OMBREDANNE
25 cm, 10" 700 g
33700-07



HAJEK
21 cm, 8 1/4" 140 g
33700-08



Slotted Hammer
33700-09
33700-11



33700-50 500 g



33701-35 350 g
33701-50 500 g
33701-70 700 g

Raspatorien
 Periosteal Elevators
 Periostótomos
 Periostotomi

12,5 mm



FARABEUF
 33702-15
 15 cm, 5.9"

12,5 mm



FARABEUF
 33703-15
 15 cm, 5.9"

11 mm

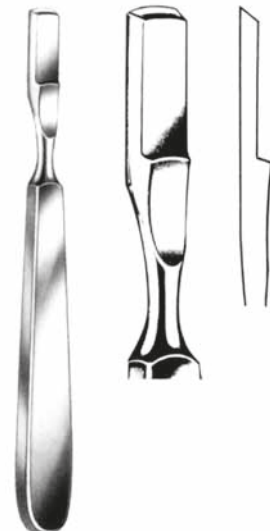

FARABEUF-COLLIN
 33704-01
 15,5 cm, 6"

11 mm

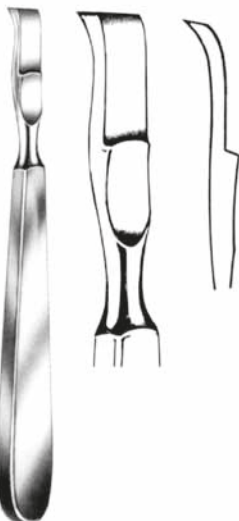

FARABEUF-COLLIN
 33704-02
 15,5 cm, 6"



LAMBOTTE
 21 cm, 8 1/4"
 33705-05 5 mm
 33705-10 10 mm
 33705-15 15 mm
 33705-20 20 mm
 33705-25 25 mm

18 mm



SEDILLOT
 18 cm, 7"
 33706-18

Raspatorien
 Periosteal Elevators
 Periostótomos
 Periostotomi

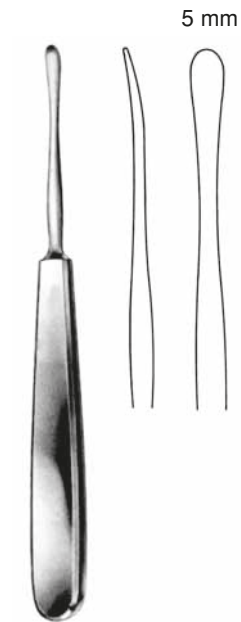

SEBILEAU
 17,5 cm, 7"
 33707-17

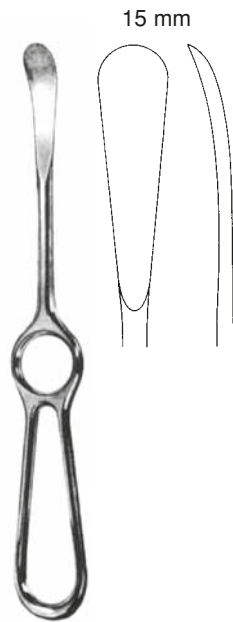

SEDILLOT
 21 cm, 8 1/4"
 33709-21

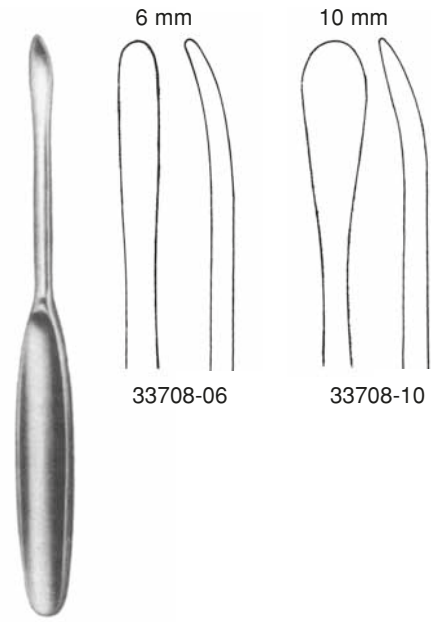

QUERVAIN
 19,5 cm, 7 3/4"



LANGENBECK
 19 cm, 7 1/2"
 33710-19



LANGENBECK
 18 cm, 7"
 33711-18



LANGENBECK
 20 cm, 8"
 33711-20 8 mm
 33711-21 10 mm

Raspatorien, Elevatoren
 Raspatories, Elevators
 Periostótomos, Elevadores
 Periostotomi, Elevatori

4 mm



WILLIGER
 33711-16
 16 cm, 6 1/4"

6,5 mm



WILLIGER
 33712-16
 16 cm, 6 1/4"

5 mm



WILLIGER
 33713-16
 16 cm, 6 1/4"

5,5 mm



WILLIGER
 33713-17
 17 cm, 6 3/4"

5 mm

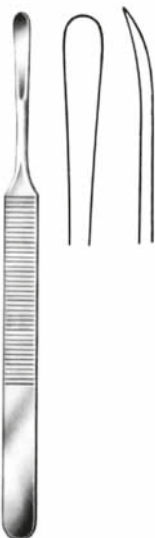

KÖNIG
 33714-15
 15,5 cm, 6"

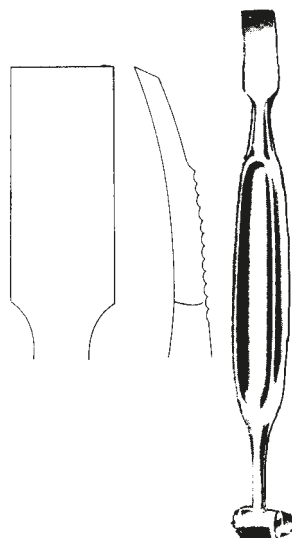

ALEXANDER
 33715-20
 20 cm, 8"



MOLT
 33716-18
 18 cm, 7"

Raspatorien, Elevatoren
Raspatories, Elevators
Periostótomos, Elevadores
Periostotomi, Elevatori

4 mm



JOSEPH
33718-16
16 cm, 6 1/4"

4 mm



FOMON
33719-17
17 cm, 6 3/4"

9 mm

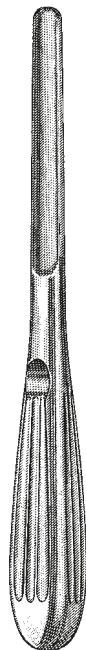

BOIES
33720-19
19 cm, 7 1/2"



GORNEY
33720-21
21 cm, 8 1/4"

Raspatorien, Elevatoren
 Periosteal Elevators
 Periostótomos, Elevadores
 Periostotomi, Elevatori



DOYEN
 17 cm
 6 3/4"

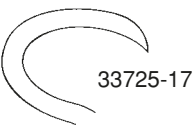
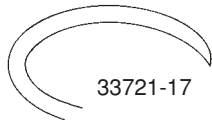

DOYEN
 17 cm
 6 3/4"

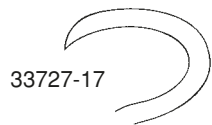
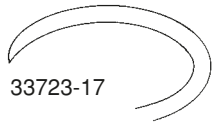

DOYEN
 33728-24 33729-24
 24 cm 9 1/2"



SEMB
 33729-01 -
 33729-07

12 mm



33729-01
 17,5 cm
 7"

12 mm



33729-02
 21 cm
 8 1/4"

12 mm



33729-03
 17,5 cm
 7"

13 mm



33729-04
 21 cm
 8 1/4"

15 mm



33729-05
 20,5 cm
 8"

15 mm



33729-06
 20,5 cm
 8"

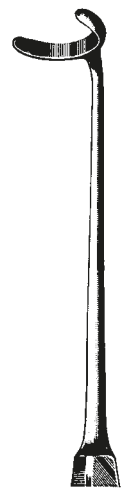

33729-07
 22,5 cm
 8.9"

Elevatoren, Raspatoren
Elevators, Raspatories
Elevadores, Periostótomos
Elevatori, Periostotomi

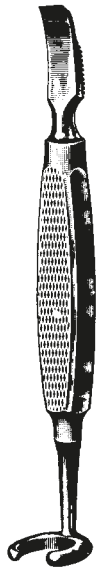

MATSON-ALEXANDER
33731-22

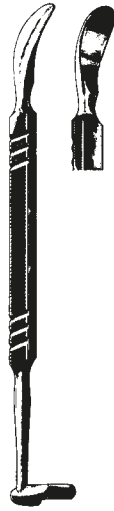

MATSON
33733-22
22 cm, 8 3/4"



OVERHOLT
33735-29
29,5 cm, 11 1/2"



OVERHOLT
33737-29
29,5 cm, 11 1/2"



OVERHOLT
33739-28
28,5 cm, 11 1/4"



33740-19
19 cm, 7 1/2"



33741-18
18,5 cm, 7 1/4"

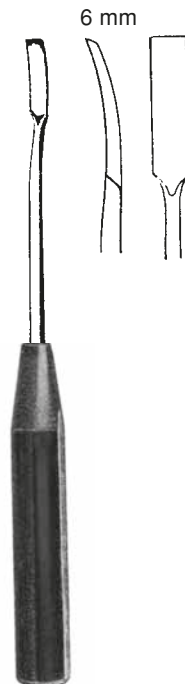

33742-18
18,5 cm, 7 1/4"



33743-18
18,5 cm, 7 1/4"

Elevatoren, Raspatoren
Elevators, Raspatories
Elevadores, Periostótomos
Elevatori, Periostotomi

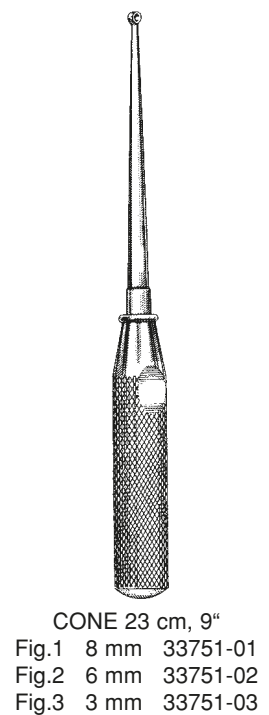
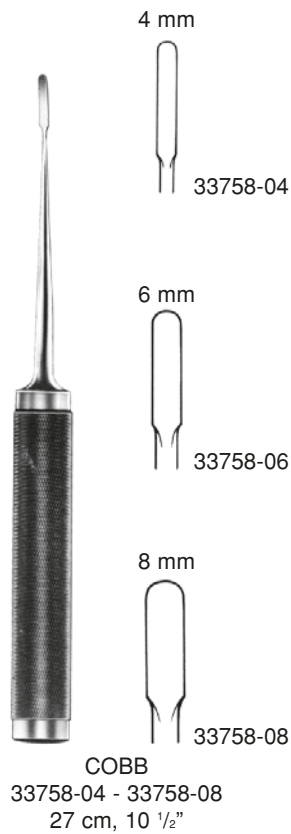
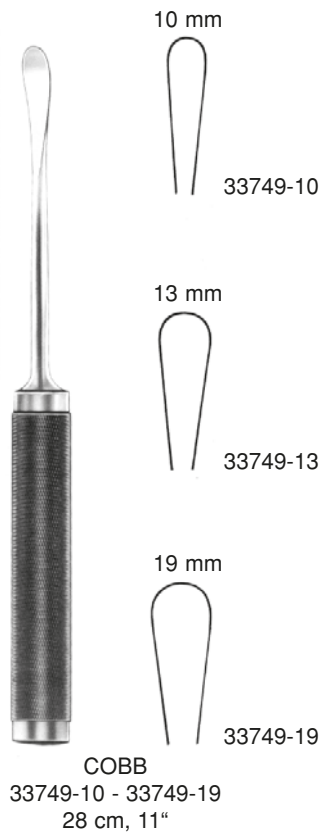
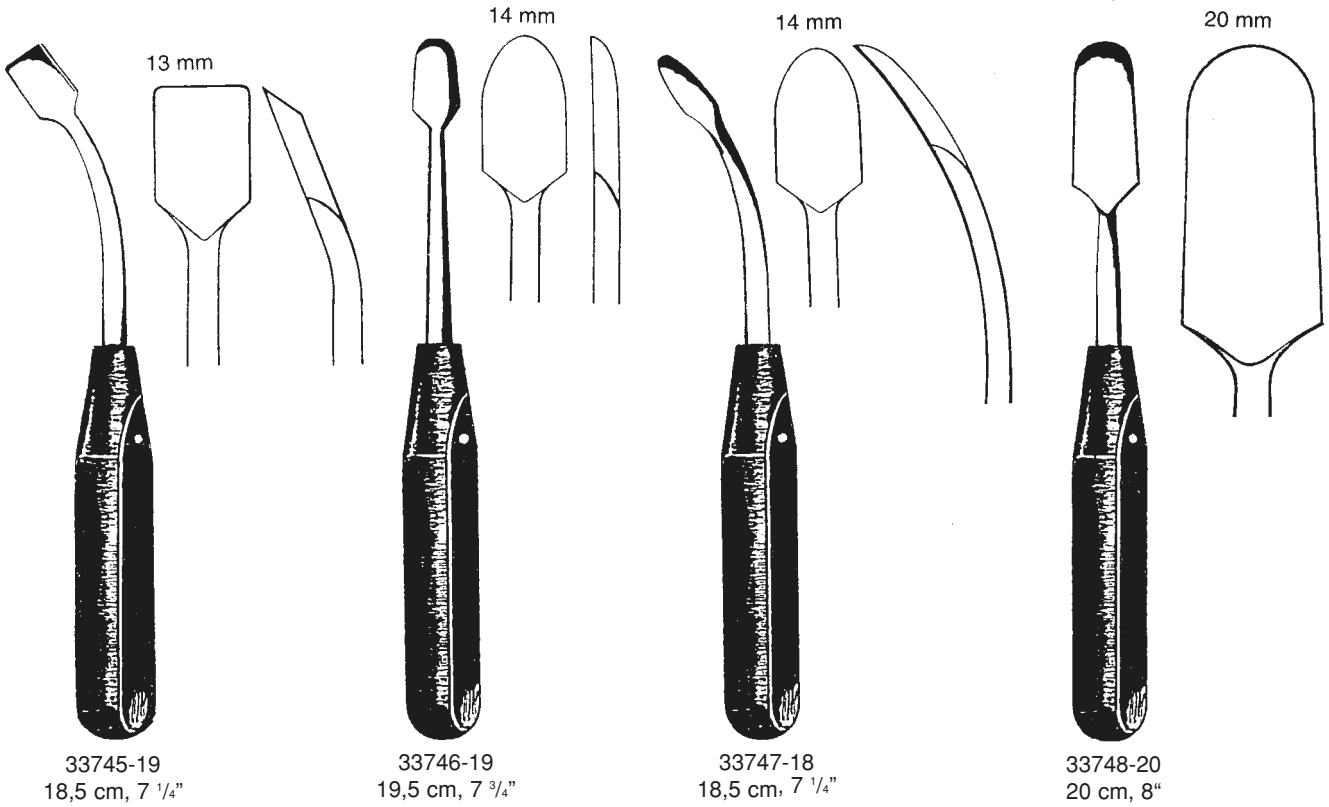

Elevatoren
Elevators
Elevadores
Elevatori

scharf
sharp
cortante
tagliente



SAYRE
17 cm, 6 ³/₄"
33758-01

stumpf
blunt
romo
smusso



SAYRE
17 cm, 6 ³/₄"
33758-02

Elevatoren, Knochenhebel
Elevators, Bone Levers
Elevadores para huesos
Elevatori, Elevatori per ossa

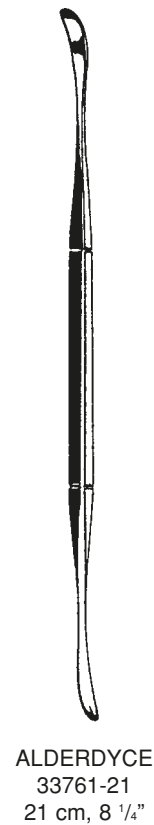
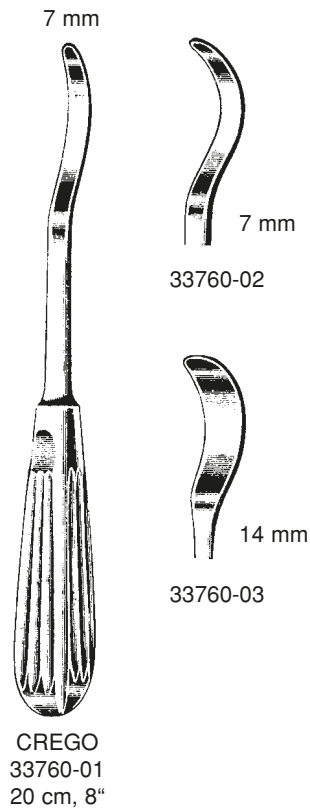
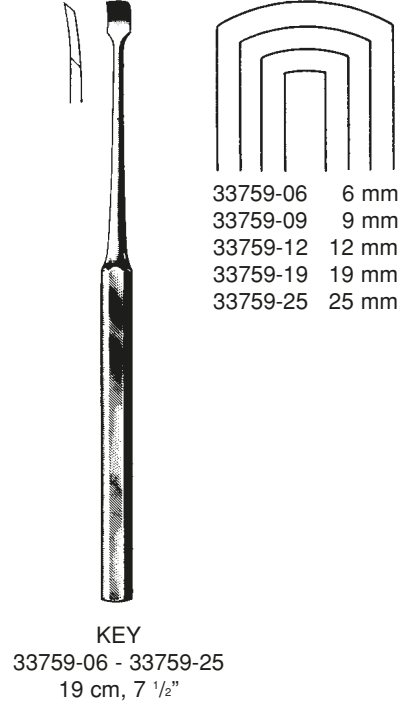

Elevatoren, Knochenhebel
 Elevators, Bone Levers
 Elevadores para huesos
 Elevatori, Elevatori per ossa



16,5 cm, 6 1/2"

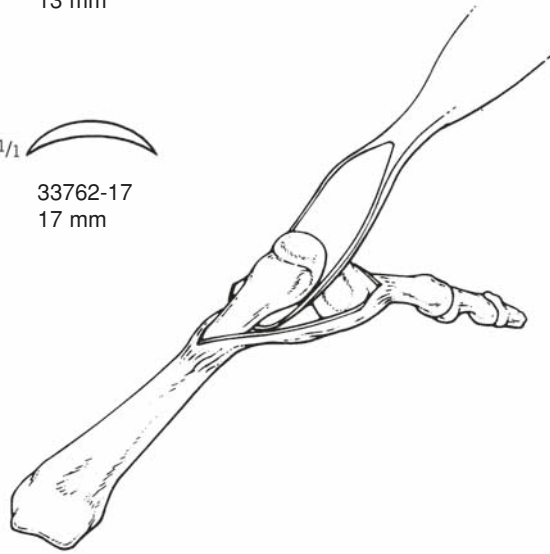
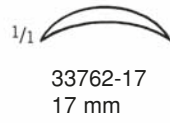
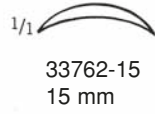
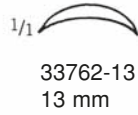

CHANDLER



33763-01
19,0 cm, 7 1/2"



33763-02
20,3 cm, 8"



33763-03
22,9 cm, 9"



33763-04
25,4 cm, 10"

Elevatoren, Knochenhebel
Elevators, Bone Levers
Elevadores para huesos
Elevatori, Elevatori per ossa



WATSON-CHEYNE
33765-17
17,5 cm, 7"



MC DONALD
33767-19
19 cm, 7 1/2"



MURPHY-LANE
33769-30
30 cm, 11 3/4"



BENNETT
33771-71
65x260 mm



BENNETT
33771-73
45x260 mm

Knochenhebel
 Bone Levers
 Elevadores para huesos
 Elevatori per ossa

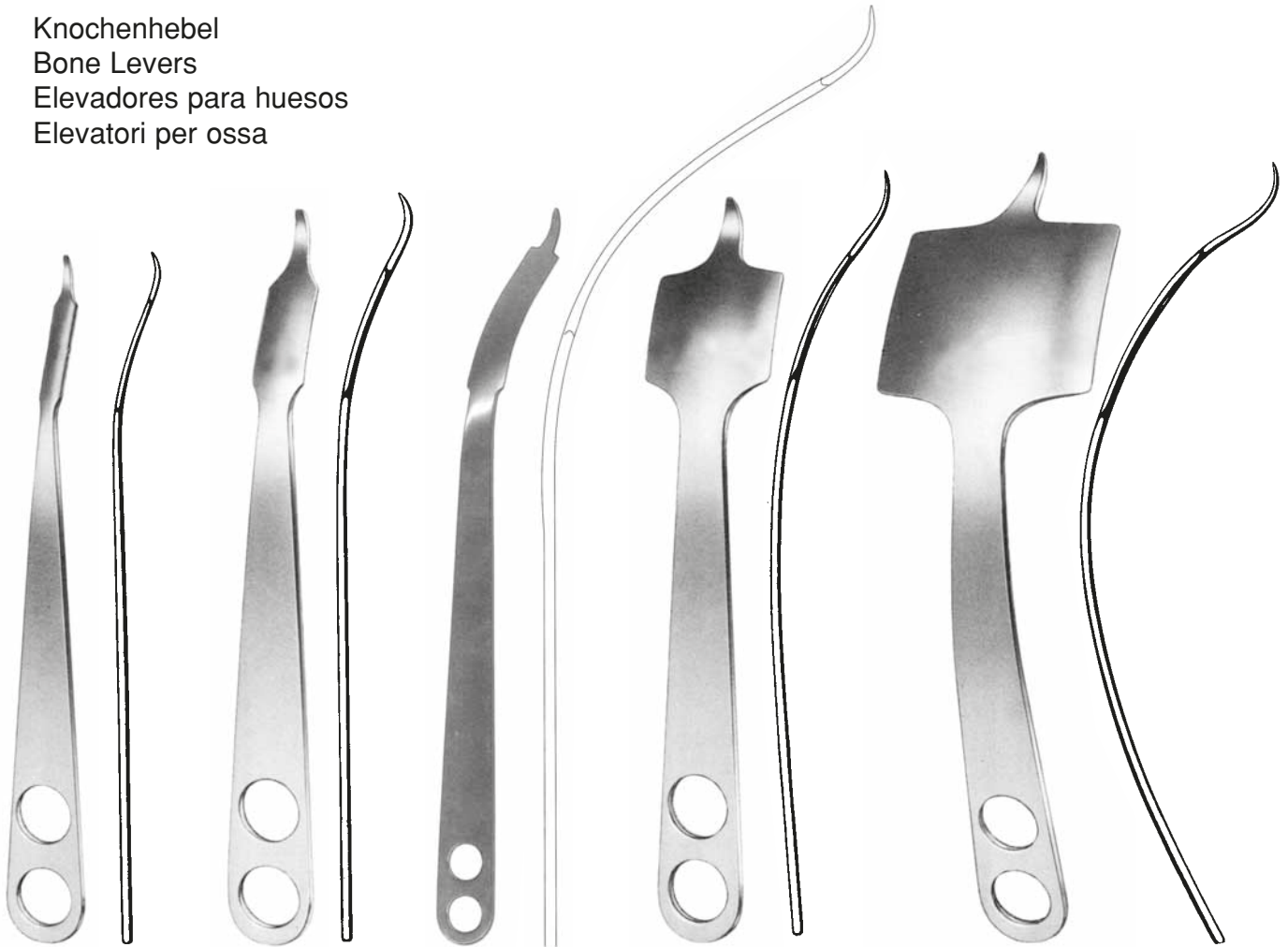

HOHMANN
 33801-08 8 mm
 33801-12 12 mm

HOHMANN
 33801-18
 18 mm, 3/4"

HOHMANN
 33801-22
 22 mm

HOHMANN
 33801-43
 43 mm, 1 3/4"

HOHMANN
 33801-70
 70 mm, 2 3/4"



KÖNIG
 33802-01
 15 cm, 6"



KÖNIG
 33802-02
 15 cm, 6"



33802-14
 14 cm, 5 1/2"

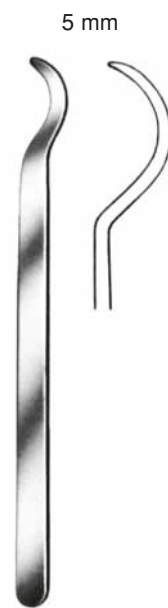

33803-05
 15 cm, 6"

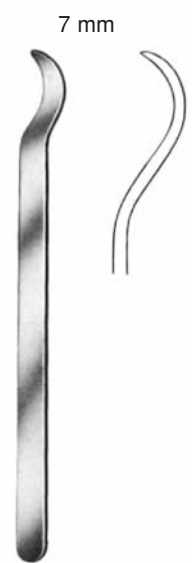

33803-07
 15 cm, 6"

Knochenhebel
Bone Levers
Elevadores para huesos
Elevatori per ossa



HOHMANN
33803-43
43 mm

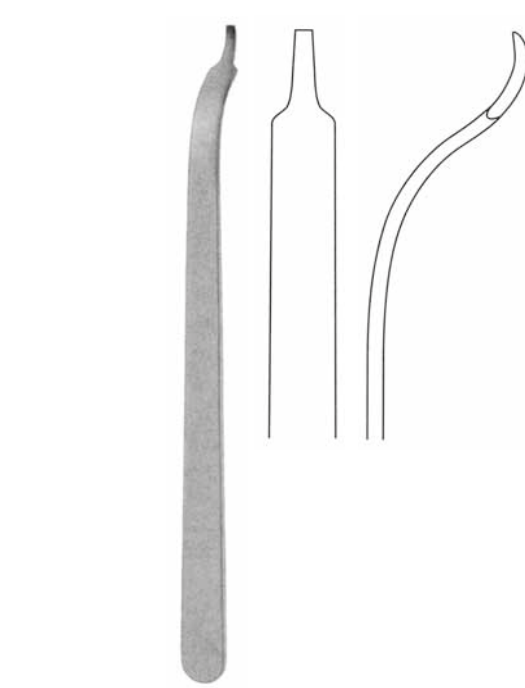

BUCK-GRAMCKO
33804-15
15 mm



HOHMANN
33805-22
22 mm



HOHMANN
33805-33
33 mm



HOHMANN
33807-24
24 mm



HOHMANN
33809-22
22 mm

Knochenhebel
 Bone Levers
 Elevadores para huesos
 Elevatori per ossa

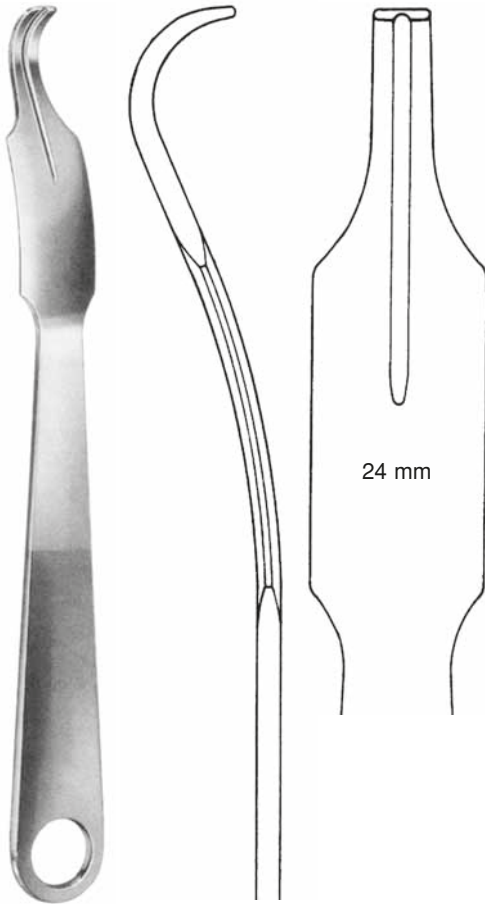

LANGE-HOHMANN
 33810-24
 25 cm, 10"

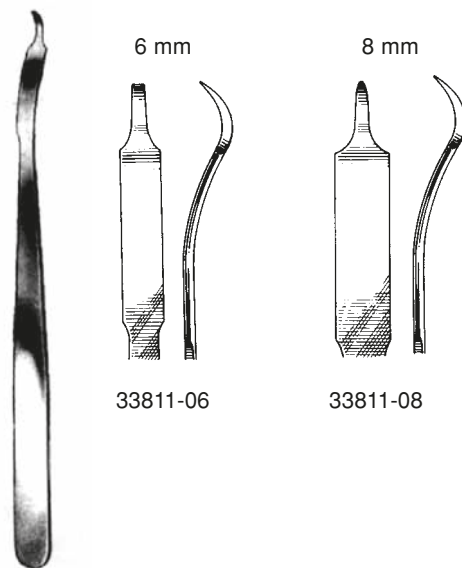

HOHMANN mini
 16 cm, 6 1/4"

Knochenhebel
Bone Levers
Elevadores para huesos
Elevatori per ossa



VERBRUGGE-MÜLLER
33814-44
33814-65
24 mm

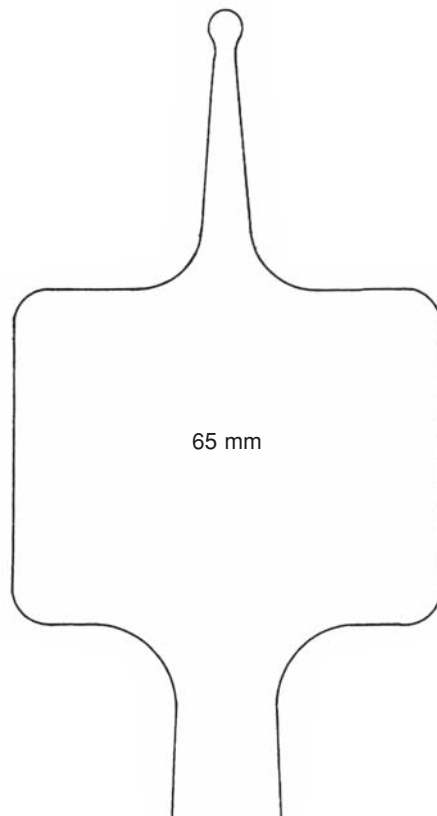
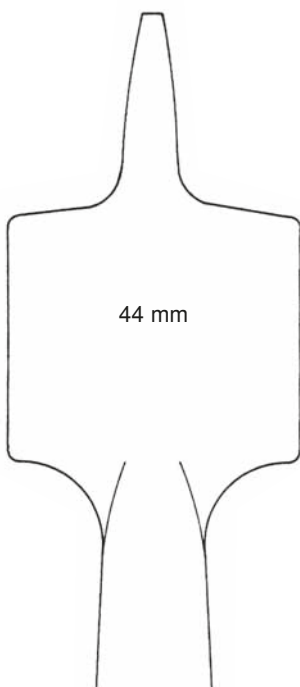
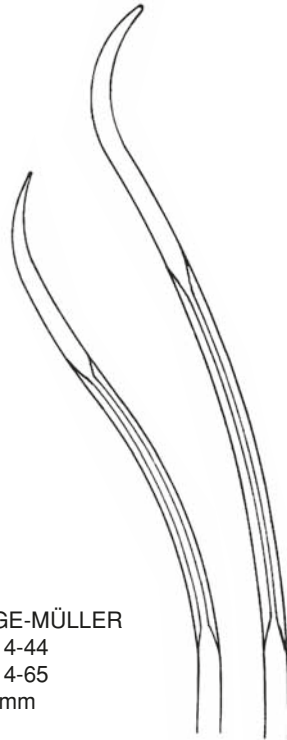

Knochenhebel
Bone Levers
Elevadores para huesos
Elevatori per ossa



33820-22
25 cm, 10"



18 cm, 7"

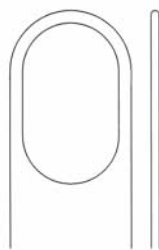

33821-32

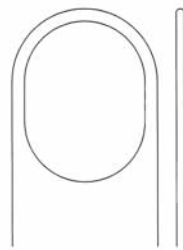

33821-38

Knochenhebel
Bone Levers
Elevadores para huesos
Elevatori per ossa



Hohmann Mini
33818-08
16 cm, 6 1/4"

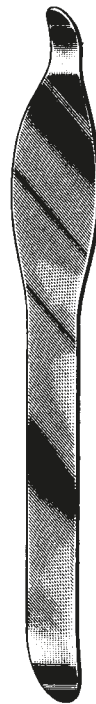

BLOUNT
33823-26
26 cm, 10 1/4"

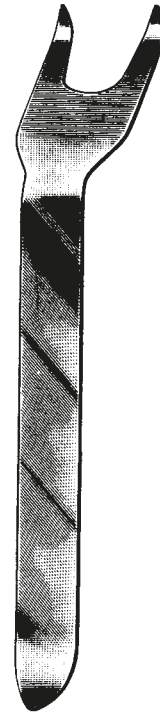

BLOUNT
33825-26
26 cm, 10 1/4"

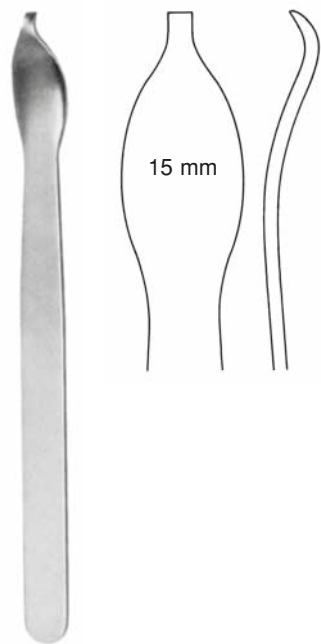

33812-16
16 cm, 6 1/4"

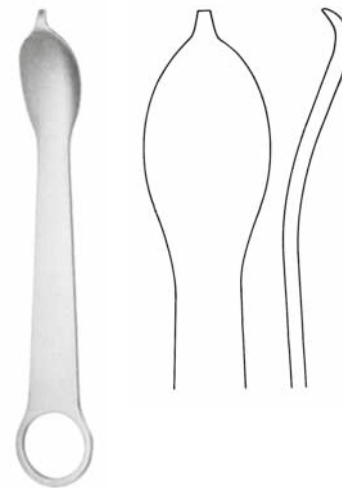

33813-12
12 cm, 4 3/4"

Knochenheber, Meniskushaken
 Bone Levers, Meniscus Retractors
 Elevadores p. huesos, Separadores para menisco
 Elevatori per ossa, Divaricatori per il menisco

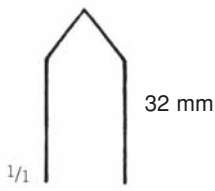
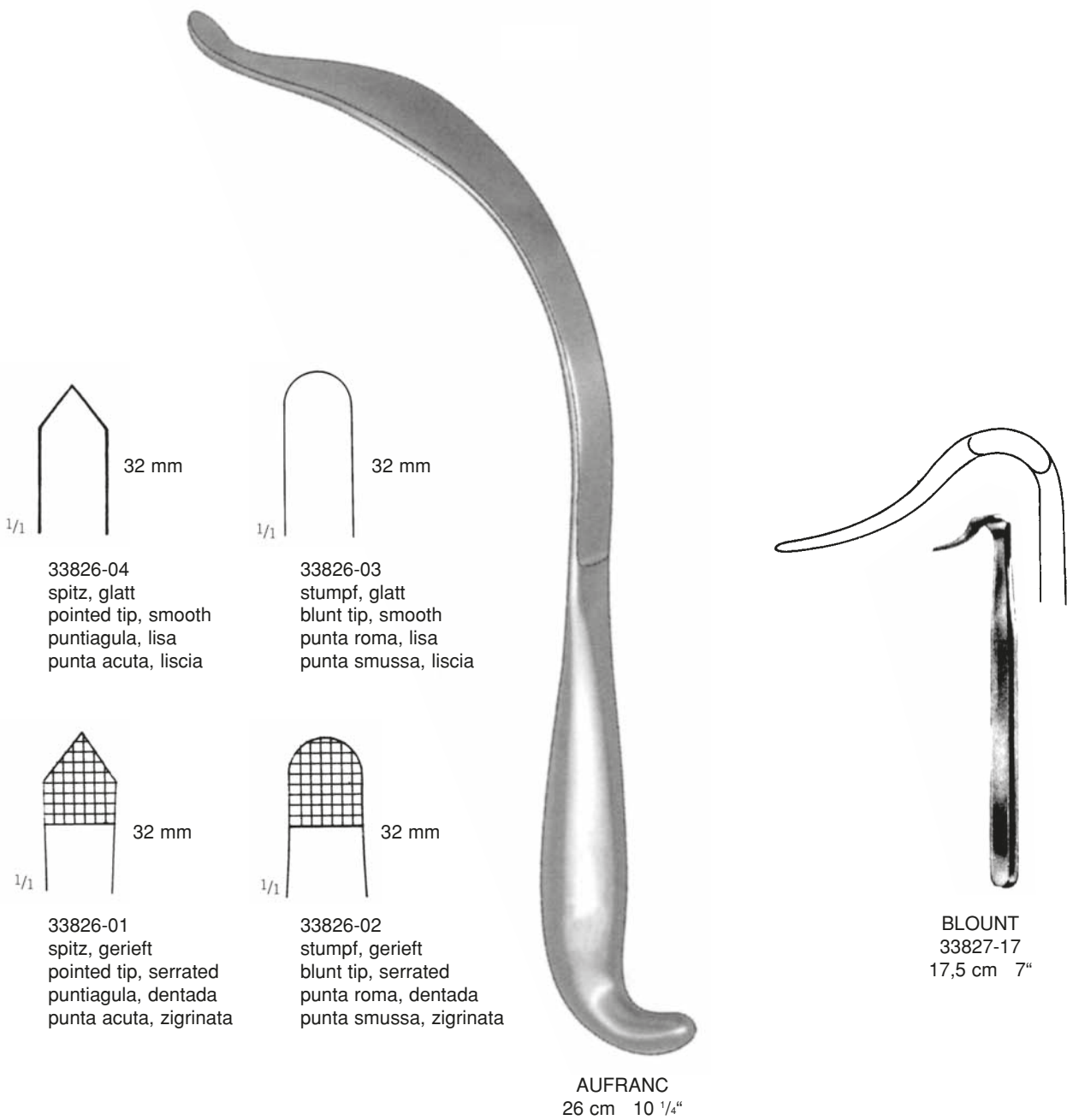

33826-04
 spitz, glatt
 pointed tip, smooth
 puntiagula, lisa
 punta acuta, liscia

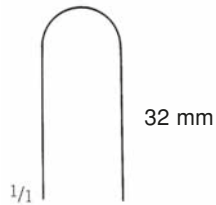

33826-03
 stumpf, glatt
 blunt tip, smooth
 punta roma, lisa
 punta smussa, liscia

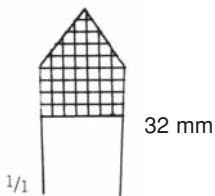

33826-01
 spitz, gerieft
 pointed tip, serrated
 puntiagula, dentada
 punta acuta, zigrinata

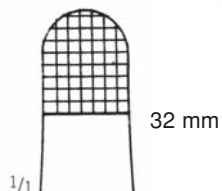

33826-02
 stumpf, gerieft
 blunt tip, serrated
 punta roma, dentada
 punta smussa, zigrinata

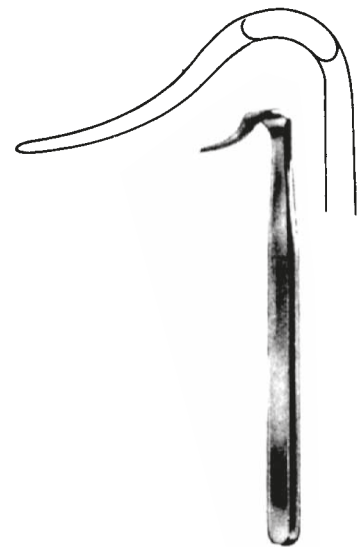

BLOUNT
 33827-17
 17,5 cm 7"

AUFRANC
 26 cm 10 1/4"

Knochenhebel
Bone Levers
Elevadores p. huesos
Elevatori per ossa



LANE TRETOWAN
33828-21
21,5 cm 8 1/2"

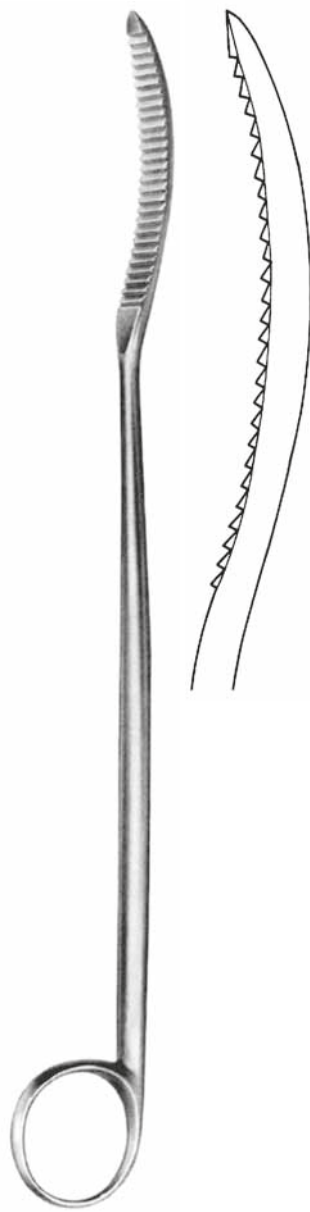

LANE
33829-25
25,5 cm 10"

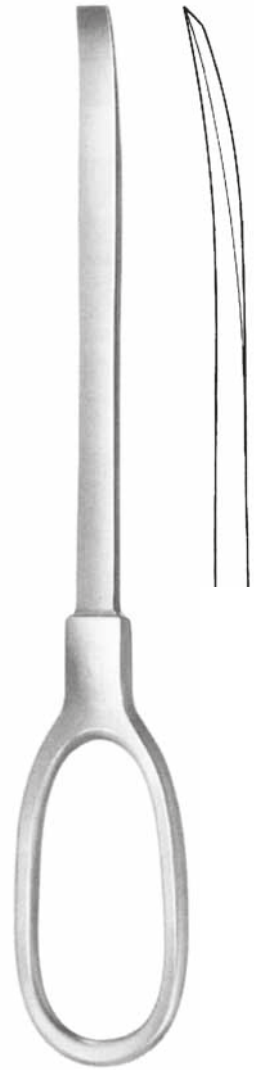

BRISTOW
33830-23
23 cm 9"

Knochenhebel, Meniskushaken
 Bone Levers, Meniscus Retractors
 Elevadores p. huesos, Separadores para menisco
 Elevatori per ossa, Divaricatori per il menisco

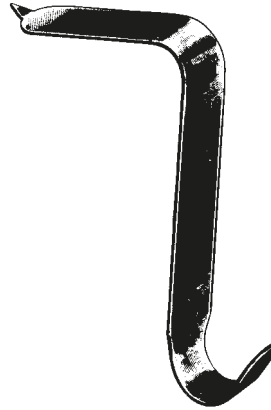

TAYLOR
 16,5 cm, 6 1/2"
 33831-16 75 x 30 mm
 33833-16 100 x 30 mm



12 x 13 mm
 33832-01



52 x 13 mm
 33832-02



SMILLIE
 14 cm, 5 1/2"

32 x 19 mm
 33832-03

48 x 19 mm
 33832-04

57 x 19 mm
 33832-05

Sehnenschäler, Sehnenfaßpinzette, Sehnenthaltezange, Sehnenfaßinstrumente
 Tendon seizing instruments
 Instrumentos para coger tendones
 Enucleatore di tendine, Strumenti per afferrare tendini



SMILLIE
 33910-17
 17 cm, 6 3/4"

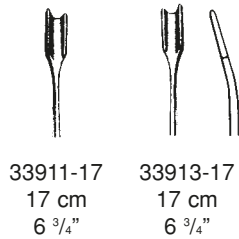

33911-17 17 cm 6 3/4"
 33913-17 17 cm 6 3/4"

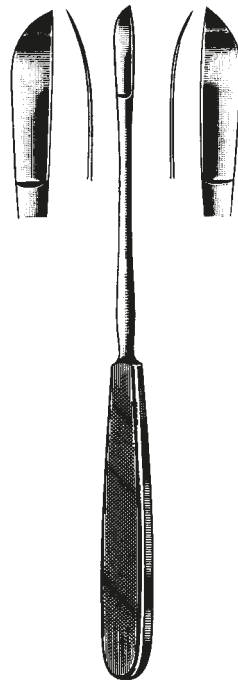

NEFF
 33921-22 - 33923-22
 22 cm, 8 3/4"



33950-01 3 mm
 33950-02 4 mm
 33950-03 5 mm
 33950-04 6 mm
 33950-05 7 mm
BUNELL
 33950-01 - 33950-05
 15 cm, 6"



LARSEN
 33960-15 - 33960-55
 10 cm, 4"

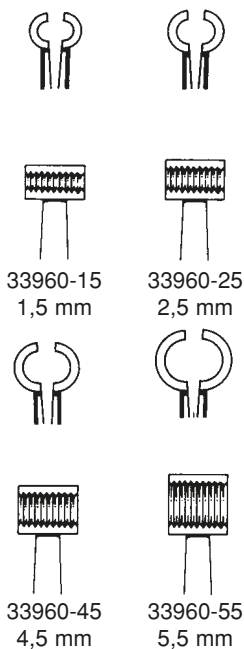

33960-15 1,5 mm
 33960-25 2,5 mm
 33960-45 4,5 mm
 33960-55 5,5 mm



JACKSON
 33961-15
 15 cm, 6"

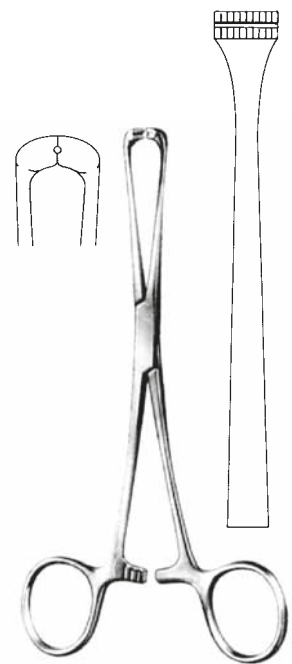

STEINMANN
 33962-16
 16 cm, 6 1/4"

Sehnenfaßinstrumente, Sehnenführer
 Tendon seizing instruments, Tendon passing instr.
 Instrumentos para coger tendones, Instrumento p. el tunel del tendon
 Strumenti per afferrare tendini



33963-12
 12 cm, 4 3/4"



BRAND
 33964-15 - 33964-24

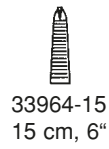

33964-15
 15 cm, 6"



33964-19
 19 cm, 7 1/2"



33964-24
 24 cm, 9 1/2"



BRAND
 33965-15 15 cm, 6"
 33965-19 19 cm, 7 1/2"
 33965-24 24 cm, 9 1/2"



CAROLL
 33966-11
 11 cm, 4 3/8"

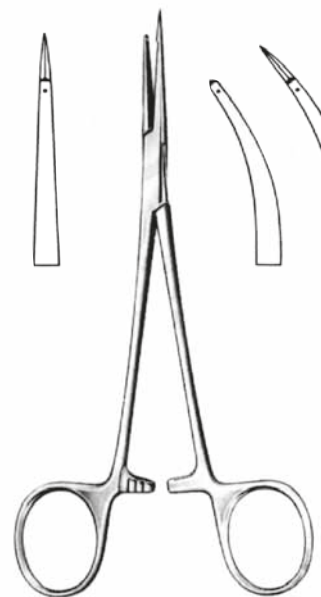
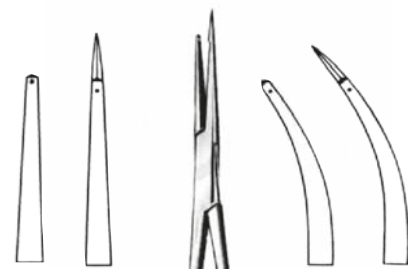

33966-15 15 cm, 6" 33967-15

Sehnenfassinstrumente, Sehnenstripper, Knochenfeilen, Raspeln
 Tendon seizing instruments, Tendon Strippers, Bone Files, Rasps
 Instrumentos para coger tendones, Enucleadores de tendones, Limas, Escofinas
 Strumenti per afferrare tendini, Scollatendini, Lime per ossa, Raspe



KLEINERT-KUTZ
 33967-20
 20 cm, 8"



ø 3 mm



33968-30
 30 cm, 11 3/4"

ø 6 mm



33968-60
 50 cm, 19 1/2"

BRAND



biegsam
 malleable
 malleables
 malleabile

BUNELL
 33969-18 18 cm, 7"
 33969-23 23 cm, 9"



biegsamer Schaft
 Flexible shaft
 Vóstago maleable
 camicia flessibile

BUNELL 23 cm
 33970-01 ø 4,0 mm
 33970-02 ø 4,5 mm
 33970-03 ø 5,5 mm



33971-24
 24,5 cm, 9 3/4"



33972-22
 22 cm, 8 3/4"

Sehnenfassinstrumente, Sehnenstripper, Knochenfeilen, Raspeln
 Tendon seizing instruments, Tendon Strippers, Bone Files, Rasps
 Instrumentos para coger tendones, Enucleadores de tendones, Limas, Escofinas
 Strumenti per afferrare tendini, Scollatendini, Lime per ossa, Raspe

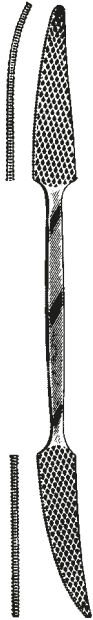

PUTTI
 33973-27
 27 cm, 10 1/2"

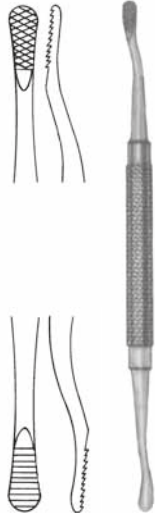

33974-18
 18 cm, 7"



PUTTI
 33975-30
 30 cm, 11 3/4"



33976-18
 18 cm, 7"

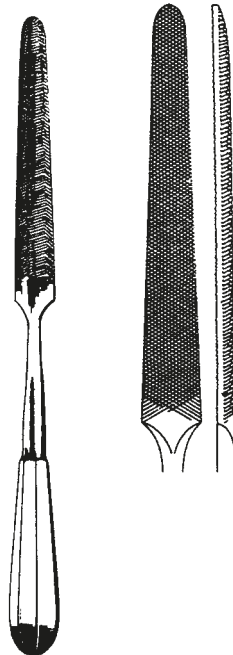

33977-28
 28 cm, 11"

Komprimeter
Pneumatic Tourniquet
Torniquete pneumático
Apparecchio di compressione

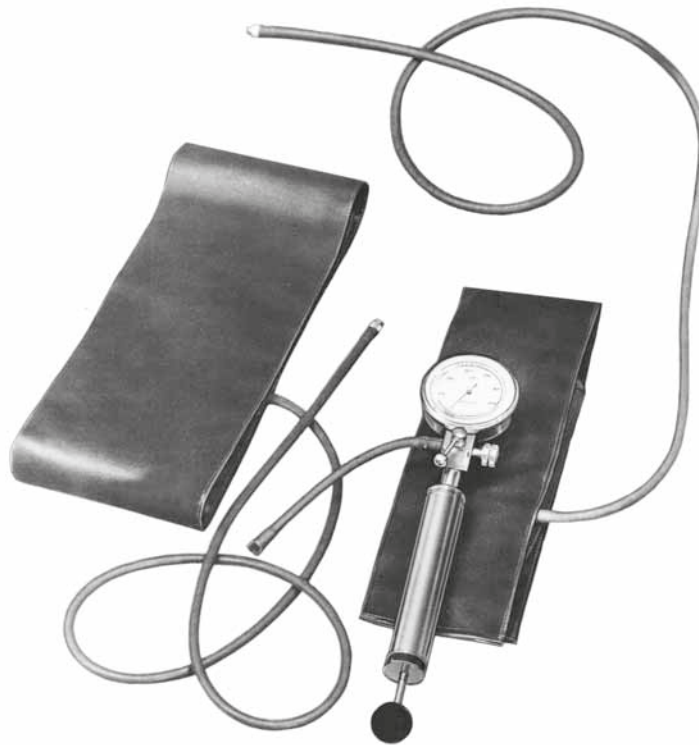

34101-01
compl.

Gerät zur Erzeugung von Blutleere in den Gliedmaßen
Compression Apparatus for producing blood vacuum in limbs
Aparato de compresión para producir el vacío de sangre en los miembros
Vacumentro per determinare vuoti di sangue nelle membra

34101-02
Pumpe
Air Pump
Bomba de aire
Pompa di aria

34101-03
Manometer
Manometer
Manómetro
Manometro

34101-04
Oberarmmanschette
Cuff for upper arm
Brazalete (brazo)
Bracciale
34101-06 incl.

34101-05
Oberschenkelmanschette
Cuff (leg)
Brazalete (pierna)
Cosciale
34101-07 incl.

34101-06
Polster für Oberarmmanschette 46 x 6 cm (18" x 2.4")
Bandage cuff for arm 46 x 6 cm (18" x 2.4")
Brazalete para brazo 46 x 6 cm (18" x 2.4")
Bracciale per braccio superiore 46 x 6 cm (18" x 2.4")

34101-07
Polster für Oberschenkelmanschette 55 x 10 cm (21 1/2 x 10")
Bandage cuff for leg 55 x 10 cm (21 1/2 x 10")
Brazalete para el fémur 55 x 10 cm (21 1/2 x 10")
Bracciale per coscia superiore 55 x 10 cm (21 1/2 x 10")

Amputations- und Resektionssägen
 Amputation and Resection Saws
 Sierras para amputación y resección
 Seghe per amputazione e resezione

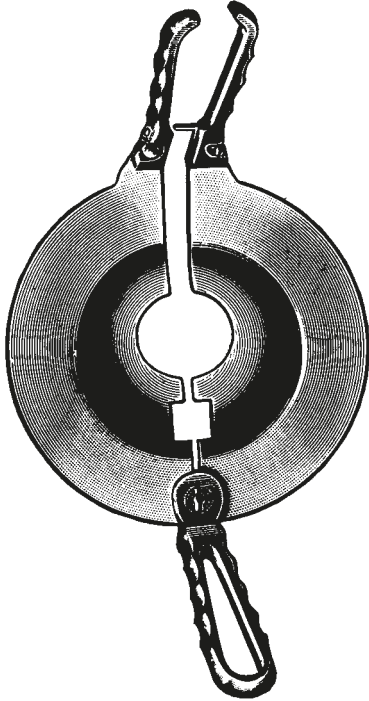

PERCY
34110-00

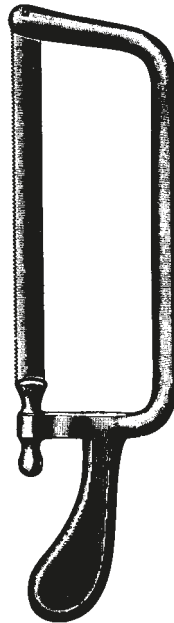

CHARRIERE
34112-00

34112-01
12 mm

Ersatzsägeblätter
 Spare saw blades
 Hojas de sierra de
 repuesto
 Lame di ricambio

34112-02
15 mm

Ersatzsägeblätter
 Spare saw blades
 Hojas de sierra de
 repuesto
 Lame di ricambio

komplett mit 2 Blättern
 complete with 2 blades
 completo con 2 hojas
 completa con 2 lame

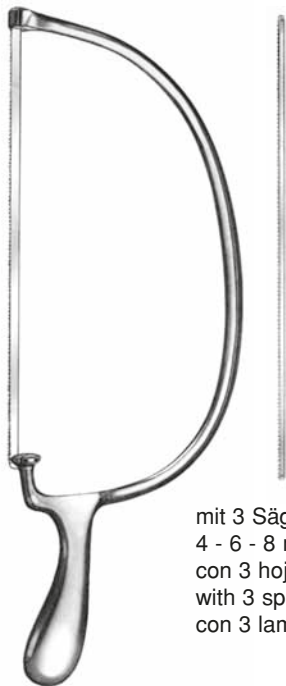

mit 3 Sägeblätter
 4 - 6 - 8 mm
 con 3 hojas de recambio
 with 3 spare blade
 con 3 lame di ricambio

BIER
34114-39
40,5 cm, 16"

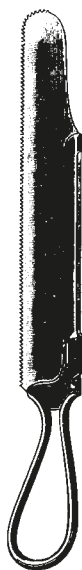

CHARRIERE
34116-30
30 cm, 11 3/4"

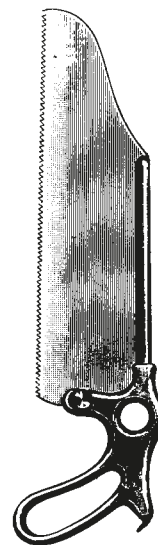

SATTERLEE
34118-31
31 cm, 12 1/4"



LANGENBECK
34120-23
23 cm, 9"

Fingernagelbohrer, Nagelausreißzange, Fingerringsägen
 Finger nail drill, Fcps. f. tearing out finger nails, Finger Ring Saws
 Perforadores para uñas, Pinzas para arrancar uñas, Sierras para abrir anillos
 Perforatore per unghie, Pinze per lacerazione delle unghie, Seghe per anelli

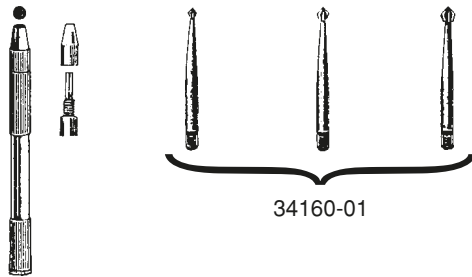

34160-00
 komplett
 complete
 completo
 completo

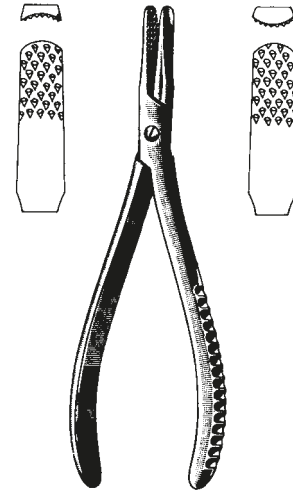

RADOLF
 34161-13 13,5 cm, 5 1/4" 3 mm
 34162-13 13,5 cm, 5 1/4" 6 mm

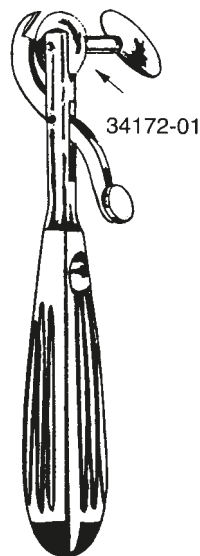

Sägeblatt
 Saw blade
 Hoja de sierra
 Lama di ricambio

WALTON
 34172-00



Sägeblatt
 Saw blade
 Hoja de sierra
 Lama di ricambio

REDA
 34175-00

Bohrapparate
 Bone Hand Drills
 Perforadores óseos manuales
 Perforatori a mano

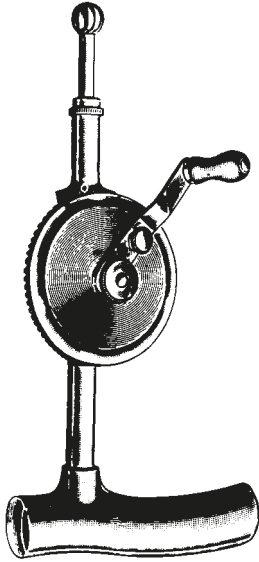

STILLE
 34210-20 20 cm, 8"
 compl. incl. 34212-25 - 34214-16

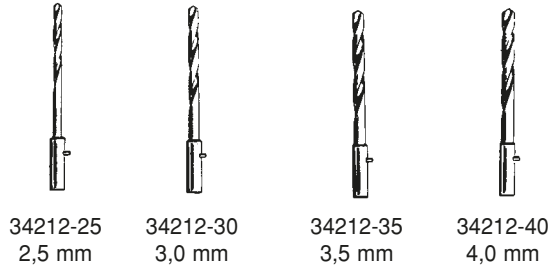

34212-25 2,5 mm 34212-30 3,0 mm 34212-35 3,5 mm 34212-40 4,0 mm

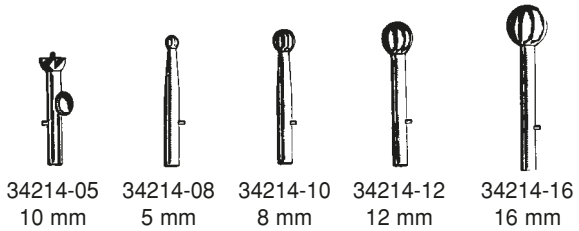

34214-05 10 mm 34214-08 5 mm 34214-10 8 mm 34214-12 12 mm 34214-16 16 mm

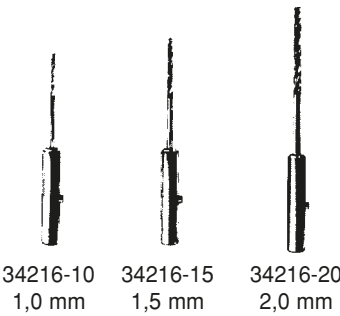

34216-10 1,0 mm 34216-15 1,5 mm 34216-20 2,0 mm

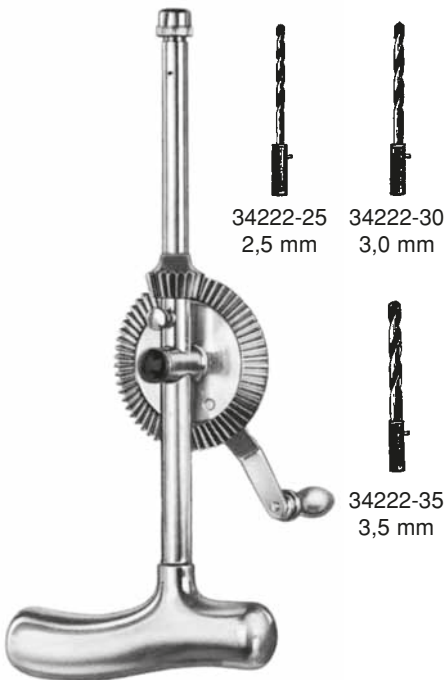

STILLE-SHERMAN
 34220-24 24 cm, 9 1/2"
 compl. incl. 34222-25 - 34222-35

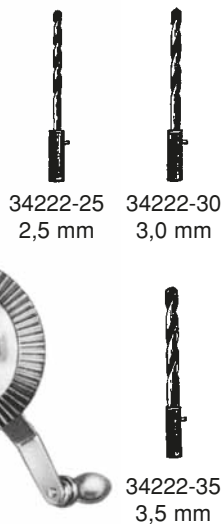

34222-25 2,5 mm 34222-30 3,0 mm
 34222-35 3,5 mm

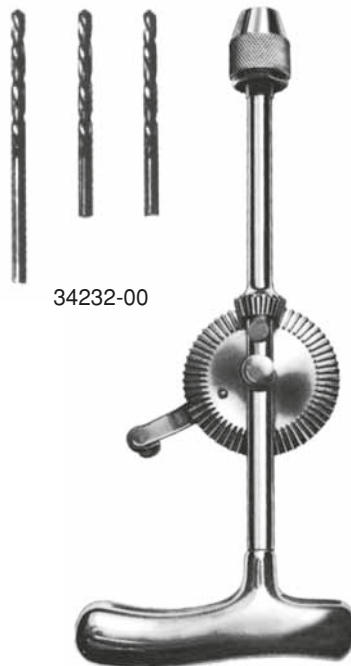

MOORE
 34230-28 28 cm, 11"
 compl. incl. 34232-00



34232-00

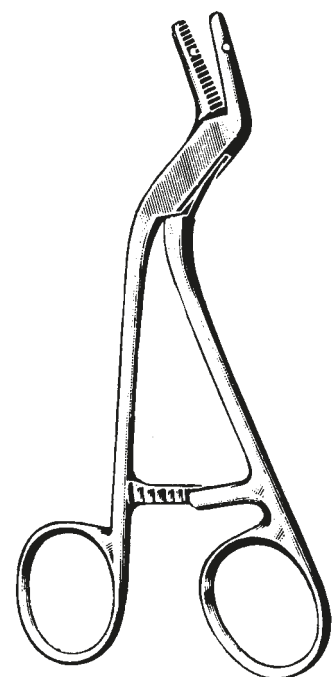

ADSON
 34231-15 15 cm, 6"

**Bohrapparate
Bone Hand Drills
Perforadores óseos manuales
Perforatori a mano**



34241-00
Griff allein
Handle only
Mango solo
Manico solo

HUDSON
34240-27 27 cm, 10 1/2"
compl. incl. 34242-09, -14, -16, -22,
34246-00



34242-09
9 mm



34242-14
14 mm



34242-16
16 mm



34242-22
22 mm



ø 2 mm
34243-02



CUSHING
34244-10
34244-14
34244-16



ERRICO
34244-17
ø 16 mm



MC KENZIE
34248-00
ø 13 mm



34246-00
Verlängerungsstück
Extension piece
Pieza alargadera
Giunto di prolungamento

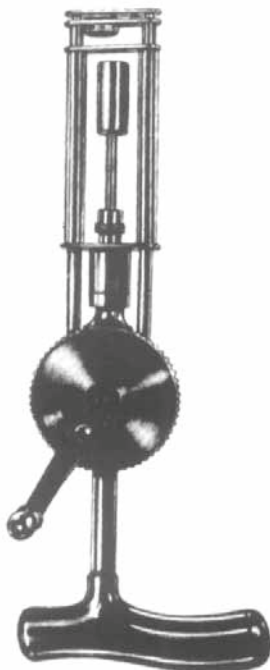

KIRSCHNER
34250-00 compl.



34252-00

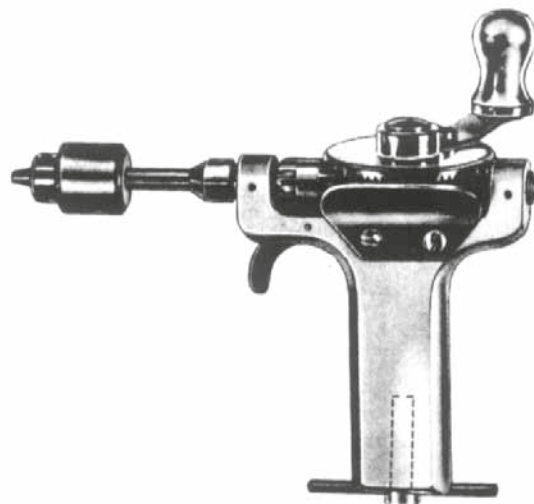

34270-01
Schlüssel
Wrench
Llave
Chiave

BUNELL
34270-00 16 cm, 6 1/4"

Bohrapparat 16 cm (6 1/4"), längsdurchbohrt mit Dreibackenspannfutter und Schlüssel, Spannweite bis 4 mm
Hand drill, 16 cm (6 1/4"), longitudinally bored, with three-jaw-chuck and key, opening up to 4 mm
Perforador manual, 16 cm (6 1/4"), taladrado longitudinalmente, con mandril de tres mordazas y llave, abriendo hasta 4 mm
Perforatore a mano, 16 cm (6 1/4"), con perforazione assiale, con mandrino a tre ganasce e chiave, apertura fino a 4 mm di D.

Bohrapparate, Handgriffe
 Bone Hand Drills, Handles
 Perforadores óseos manuales
 Perforatori a mano, manici



RALK
34280-00



REDA
34290-00

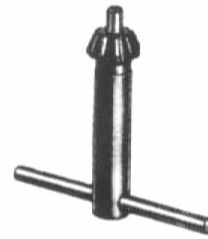

34295-00

Spannschlüssel allein
 Key only
 Llave suelta
 Chiave solo



34296-00

Handgriff mit Jacobs-
 spannfutter und
 Spannschlüssel
 Handle with Jacobs chuck
 and key
 Mango con cierre Jacobs,
 de 3 mordazas y llave
 Manico con mandrino di
 Jacobs e chiave

Bohrapparat mit Leichtmetallgehäuse, mit Dreibackenspannfutter und Schlüssel, Spannweite bis D. 6,35 mm
 Hand drill with light metal case, with three-jaw-chuck and key, opening up to D. 6,35 mm
 Perforador manual con caja de aluminio, con mandril de tres mordazas y llave, abriendo hasta 6,35 mm de D.
 Perforatore a mano con cassa in metallo leggero, con mandrino a tre ganasce e chiave, apertura fino a 6,35 mm di D.

Handbohrapparat mit umstellbarem Handgriff, mit Jacobs Dreibackenspannfutter und Schlüssel
 Hand drill with adjustable handle, with Jacobs three-jaw-chuck and wrench
 Perforador de mano en T con cierre Jacobs de 3 mordazas y llave de ajuste
 Perforatore a mano con manico regolabile, con mandrino a tre ganasce di Jacobs e chiave



34296-05

T-Handgriff, verriegelbares schlüssellooses Dreibackenspannfutter, rostfrei
 T-handle, keyless locking chuck
 Mango en T, mordaza sin llave, inox.
 Chiave a T con mandrino a tre ganasce inox



34296-10

Handgriff, Dreibackenspannfutter, inkl. Spannschlüssel rostfrei
 Handle with chuck, including key
 Mango, mordaza incluyendo llave, inox.
 Mandrino a tre ganasce con manico recto completo di chiave di arresto inox



34296-15

"Hudson" T-Handgriff, Schnellkupplung
 Hudson T-handle with fast gripping chuck
 Mango en T, acople rápido
 Hudson: mandrino con manico a T
 Ganasce con raccordo rapido



34296-20

Schnellkupplungs T-Handgriff, groß
 T-handle with fast gripping chuck, large
 Mango en T, acople rápido, grande
 Mandrino a T manico grande
 Raccordo rapido

Schnellkupplungs-Handgriffe, Bohrapparat elektr.
 Handles with quick action chuck, Bone drill electr.
 Perforador electrico y mangos de acople rápido
 Manici con attarchi rapidi, Perforatori electr.



34296-25
 Schnellkupplungs-T-Handgriff
 T-Handle, quick-action
 Mango en T, acople rápido
 Mandrino a T con raccordo rapido



34296-30
 Schnellkupplungs-Handgriff
 groß mit Hartgewebegriff
 Handle, quick-action, large,
 handle made of very hard fibre
 Mango de acople rápido,
 grande, de material extraduro
 Mandrino grande rapido con
 manico a fibre dure



34296-35
 Schnellkupplungs-Handgriff
 mit Hartgewebegriff
 Handle, quick-action,
 made of very hard fibre
 Mango de acople rápido,
 de material extra-duro
 Mandrino medio rapido con
 manico o fibre dure



34296-40
 Mini Schnellkupplungs-Handgriff
 für „Dental“-Anschluß
 Mini-Handle, quick-action,
 "dental"
 Mini-Mango de acople rápido
 "dental"
 Mini mandrino-rapido con
 impugnatura cilindrica con
 attacco dentale

Bohrer
Drill bits
Taladros
Perforatore



Ø			
1,1 mm	45 mm	34320-11	
1,5 mm	70 mm	34320-15	
2,0 mm	85 mm	34320-20	
2,5 mm	95 mm	34320-25	
2,7 mm	85 mm	34320-27	
3,2 mm	130 mm	34320-32	
3,5 mm	100 mm	34320-35	
4,5 mm	145 mm	34320-45	
5,0 mm	132 mm	34320-50	
6,0 mm	139 mm	34320-60	
7,0 mm	156 mm	34320-70	

Spiralbohrer mit Glattschaft
Twist Drills with round end
Taladros espirales con vástago redondo
Perforatore elicoidale



Ø		
3,2 mm	180 mm	34321-32
3,5 mm	180 mm	34321-35
4,0 mm	180 mm	34321-40
4,5 mm	180 mm	34321-45
5,0 mm	180 mm	34321-50
6,0 mm	180 mm	34321-60
6,5 mm	180 mm	34321-65
7,0 mm	180 mm	34321-70

Spiralbohrer mit Glattschaft, langes Modell
Twist Drills, long typ
Taladros espirales, largos
Perforatore elicoidale, modello lungo



Ø			
1,1 mm	60 mm	34322-11	
1,5 mm	85 mm	34322-15	
2,0 mm	100 mm	34322-20	
2,5 mm	110 mm	34322-25	
2,7 mm	100 mm	34322-27	
3,2 mm	145 mm	34322-32	
3,5 mm	100 mm	34322-35	
4,5 mm	145 mm	34322-45	

Spiralbohrer mit Schnellkupplungs-Ansatz
Twist Drills, quick-action
Taladros espirales, acople rápido
Perforatore elicoidale con attacco rapido



Ø		
3,2 mm	195 mm	34323-32
3,5 mm	195 mm	34323-35
4,5 mm	195 mm	34323-45

Spiralbohrer mit Schnellkupplungs-Ansatz, langes Modell
Twist Drills, quick-action, long typ
Taladros espirales, acople rápido, largos
Perforatore elicoidale con attacco rapido, modello lungo

Gewindeschneider
Tap
Terraia p torn
Maschio per vite



1,5 mm	34330-15/38
1,5 mm	34330-15/50
2,0 mm	34330-20/38
2,0 mm	34330-20/54
2,7 mm	34330-27
3,5 mm	34330-35/125
3,5 mm	34330-35/175
4,0 mm	34330-40
4,5 mm	34330-45
4,5 mm	34330-45 S
4,5 mm	34330-45 L
6,5 mm	34330-65



2,7 mm	34331-27
3,5 mm	34331-35/125
3,5 mm	34331-35/175
4,5 mm	34331-45
6,5 mm	34331-65

Pfrieme
Awl
Escariadores
Lesine

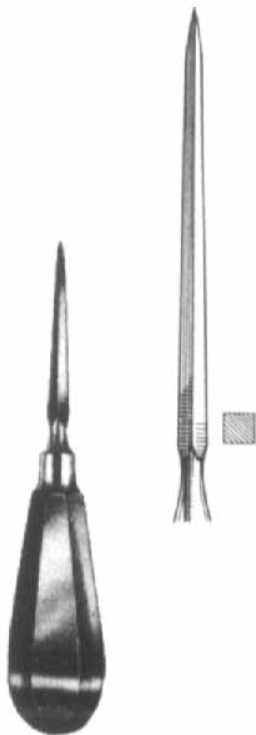

34392-14
14 cm, 5 1/2"

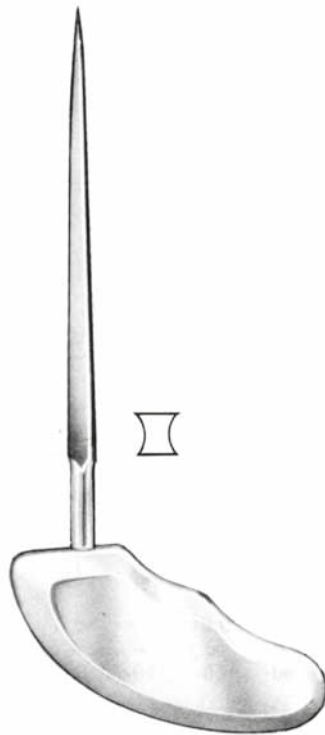

PERTHES
34393-21
21 cm, 8 1/4"

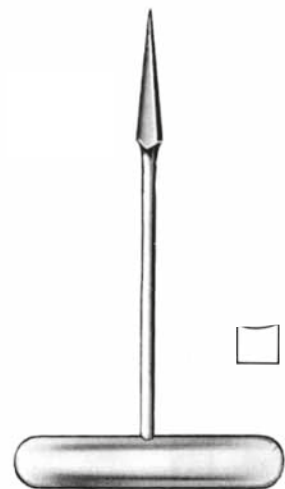

34394-14
14 cm, 5 1/2"

Faßpinzette, Bohrdrahtspender
Grasping forceps, Support for sterilisation
Pinzas para coger, Soporte de esterilización
Pinze per afferrare, Supporto per la sterilizzazione



34439-00

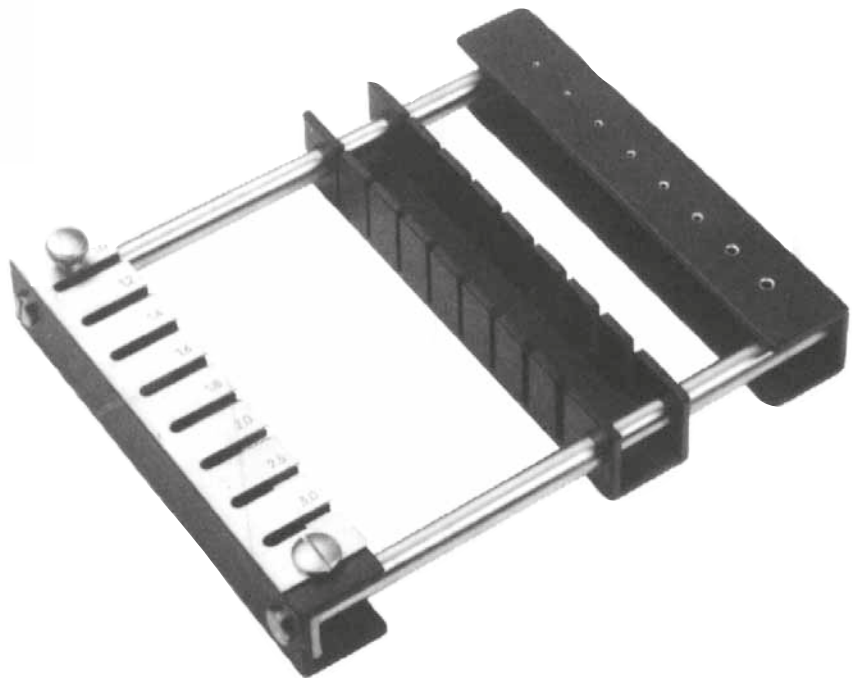

Bohrdrahtspender für Kirschner-Drähte
Support for sterilisation of Kirschner wires
Soporte de esterilización p. alambres de Kirschner
Supporto per la sterilizzazione dei fili di Kirschner

34440-01 bis 15 cm – up to 15 cm (6") – hasta 15 cm – fino a 15 cm
34440-02 bis 31 cm – up to 31 cm (12 1/4") – hasta 31 cm – fino a 31 cm
34440-03 bis 10 cm – up to 10 cm (4") – hasta 10 cm – fino a 10 cm

Bohrdrahtspender
 K-Wire Dispenser
 Dispensador para brocas filiformes
 Distributore per fili

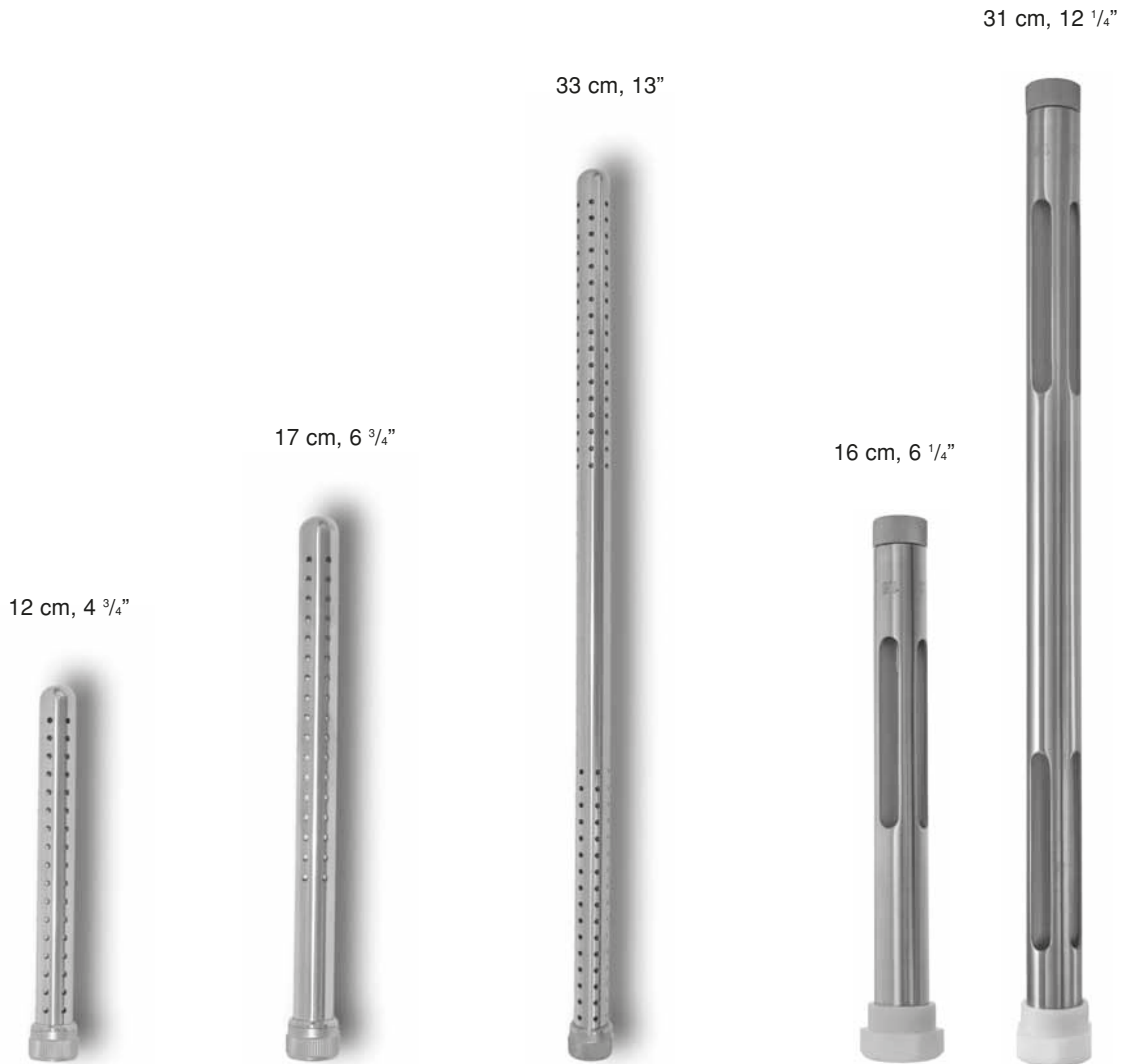

34450-08	0,8 mm	34460-08	0,8 mm	34470-08	0,8 mm
34450-10	1,0 mm	34460-10	1,0 mm	34470-10	1,0 mm
34450-12	1,2 mm	34460-12	1,2 mm	34470-12	1,2 mm
34450-14	1,4 mm	34460-14	1,4 mm	34470-14	1,4 mm
34450-15	1,5 mm	34460-15	1,5 mm	34470-15	1,5 mm
34450-18	1,8 mm	34460-16	1,6 mm	34470-16	1,6 mm
34450-20	2,0 mm	34460-18	1,8 mm	34470-18	1,8 mm
34450-22	2,2 mm	34460-20	2,0 mm	34470-20	2,0 mm
34450-25	2,5 mm	34460-22	2,2 mm	34470-22	2,2 mm
34450-30	3,0 mm	34460-25	2,5 mm	34470-25	2,5 mm
		34460-30	3,0 mm	34470-30	3,0 mm

Mehrfach Bohrdrahtspender
 K-wire dispenser multiple
 Dispensador de brocas filiformes múltiple
 Distributore per multiplo fili

34461-16	16 cm (1,0 / 1,2 / 1,4 / 1,6 mm)
34461-25	16 cm (1,8 / 2,0 / 2,2 / 2,5 mm)
34471-16	31 cm (1,0 / 1,2 / 1,4 / 1,6 mm)
34471-25	31 cm (1,8 / 2,0 / 2,2 / 2,5 mm)

Fingerschützer, Drahtgeflecht
Finger Protectors, Wire gauze
Dedales, Gasa metálica
Proteggidita, maglia metallica per estensione



34480-01



34480-02

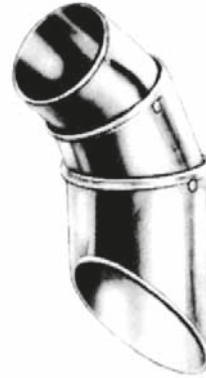

34480-03

LANGENBECK
34480-01 - 34480-03



34492-01
klein / small / pequeño / stretto

34492-02
mittel / medium / mediano / medio

34492-03
groß / large / grande / grande

34492-01 - 34492-03

sterilisierbar
sterilizable
esterilizable
sterilizzabile

Extensionsbügel
 Extension Bows
 Estribos para extensión
 Archi per estensione

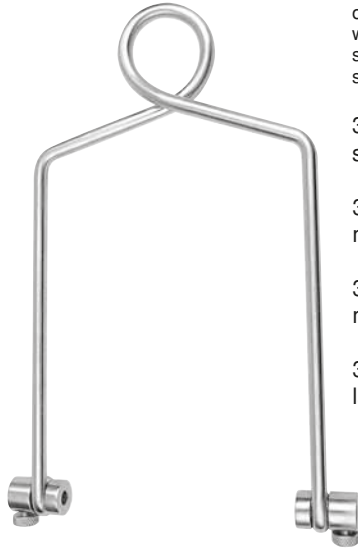

BÖHLER

ohne Trokar
without trocar
sin trocar
senza trocar

34502-09 small	9 x 7,5 cm 3 1/2" x 3"
34502-16 medium	16 x 9 cm 6 1/4" x 3 1/2"
34502-21 medium large	21 x 11 cm 8 1/4" x 4 3/8"
34503-21 large	21 x 15 cm 8 1/4" x 6"

mit Trokar
with trocar
con trocar
con trocar

34502-09 K small	
34502-16 K medium	
34502-21 K medium large	
34503-21 K large	



KIRSCHNER
 mit 3 Zughaken
 with 3 hooks
 con 3 ganchos
 con 3 ganci per trazione

34514-18 40 - 140 mm x 115 mm

34514-27 60 - 220 mm x 175 mm

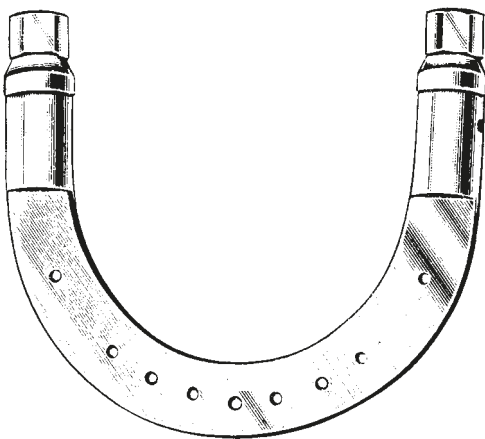

KIRSCHNER

34515-09	9,5 x 7,0 cm	3 3/4" x 2 3/4"
34515-10	9,5 x 11,0 cm	3 3/4" x 4 3/8"
34515-11	10,5 x 10,0 cm	4.1" x 4"
34515-12	12,0 x 12,0 cm	4 3/4" x 4 3/4"
34515-13	13,5 x 13,0 cm	5 1/4" x 5 1/8"
34515-15	15,5 x 15,5 cm	6" x 6"
34515-20	20,0 x 15,5 cm	8" x 6"

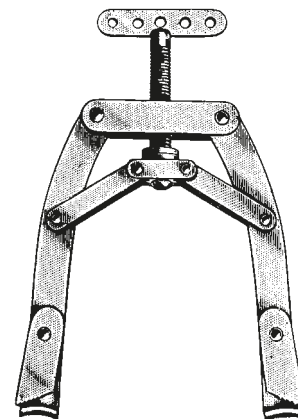

KIRSCHNER U.S.

34518-01	mittel, medium, mediano, max. 130 mm (5 1/8")
34518-02	groß, large, grande, grande, max. 185 mm (7 1/4")
34518-03	extra groß, large extra long, muy grande, max. 220 mm (8 3/4")

Mutterschlüssel, Spannschlüssel
Screw nut wrench, Wire strainer
llave de tuercas, Tensor de taladros, alambres
Chiave per madreviti, Strumenti tenditore



14 mm
17 mm
34515-01

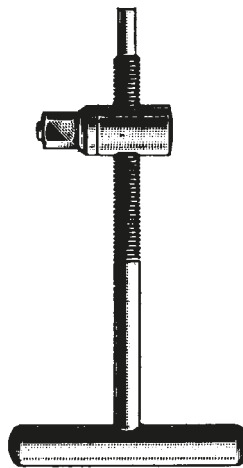

34515-02



11 mm
34516-11
Combination Wrench width
across flats 11 mm



KIRSCHNER
34519-01



KIRSCHNER
34519-02

Knochendraht
Bone wire
Hilos para huesos
Filo per ossa



weich, in Ringen zu 10 m (32,8 Feet)
soft, in coils of 10 m (32,8 Feet)
blando, de 10 m (32,8 Feet)
morbido, 10 m (32,8 Feet)

Material:
nichtrostender Implantatstahl
nach DIN 17443 (ISO 5832/1)

	mm Ø
34520-02	0,2
34520-03	0,3
34520-04	0,4
34520-05	0,5
34520-06	0,6
34520-07	0,7
34520-08	0,8
34520-09	0,9
34520-10	1,0
34520-12	1,2
34520-15	1,5

Drahtumföhrungsnadeln, Drahtspanninstrumente
 Bone wire guides, Bone wire tighteners
 Agujas pasa-hilos, Tensor cierra-hilos
 Aghi passafili, Strumenti tendifili



DEMEL
 27 cm, 10 1/2"
 Fig. 1 34528-01
 Fig. 2 34528-02
 Fig. 3 34528-03

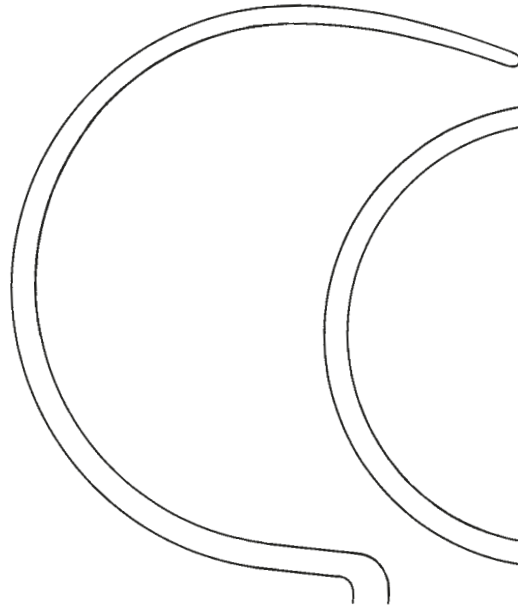

Fig. 1

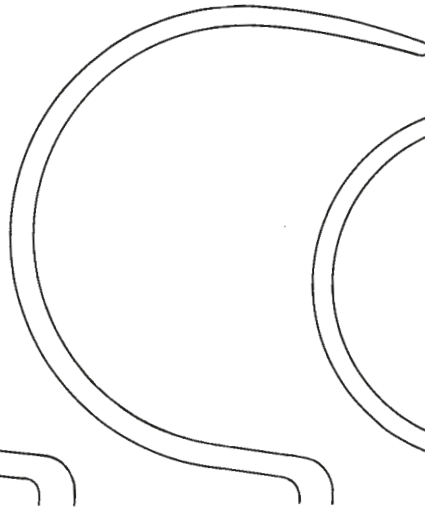

Fig. 2

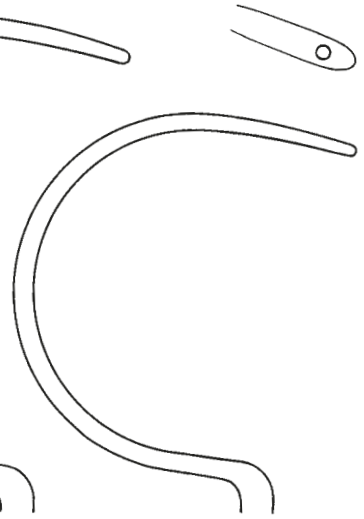
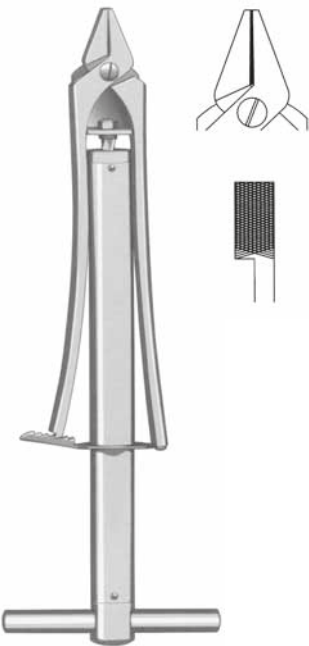
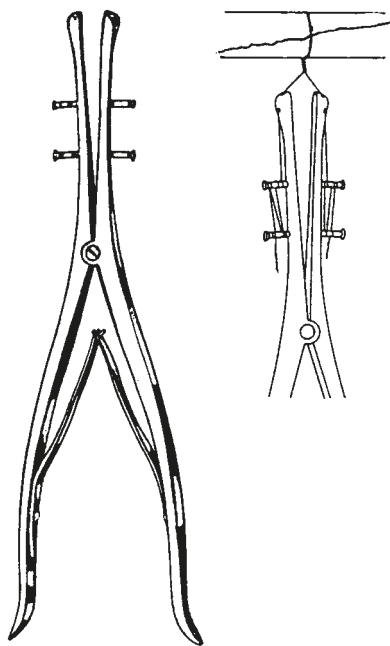

Fig. 3



34529-28 28 cm, 11"



DEMEL
 34530-28 28 cm, 11"



LOUTE
 34531-21 21 cm, 8 1/4"

Flachzangen, Faßzangen
 Flat Nose Pliers, Seizing Forceps
 Alicates planos, Pinzas para coger alambres
 Tenaglie piatte, Tenaglie per afferrare

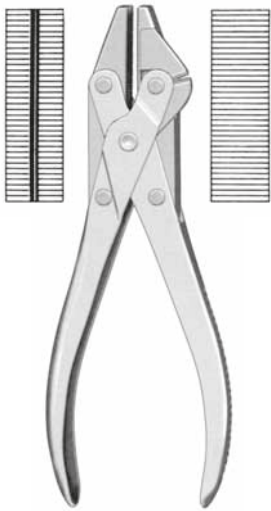

17 cm, 6 3/4"
 34533-17 INOX

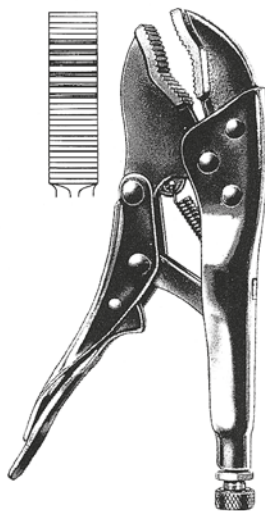

GRIP
 18 cm, 7"
 34534-18 INOX



34534-15
 15 cm, 6"



34534-21
 21,5 cm, 8 1/2"

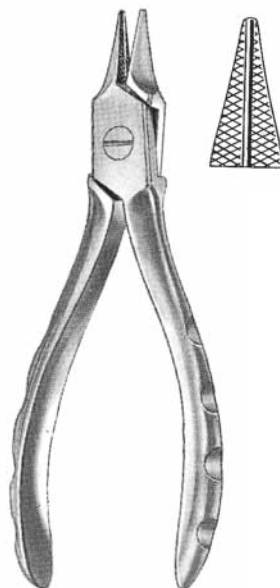

34535-16
 16 cm, 6 1/4"

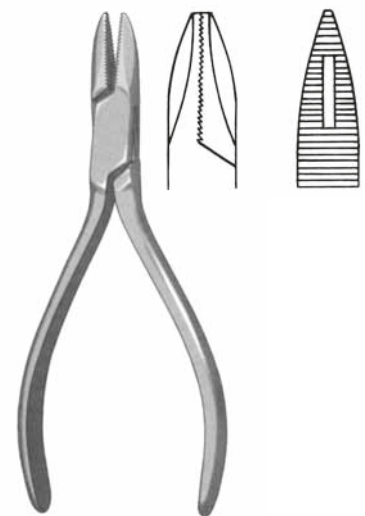

34536-02
 14 cm, 5 1/2"

Flachzangen, Faßzangen
Flat Nose Pliers, Seizing Forceps
Alicates planos, Pinzas para coger alambres
Tenaglie piatte, Tenaglie per afferrare

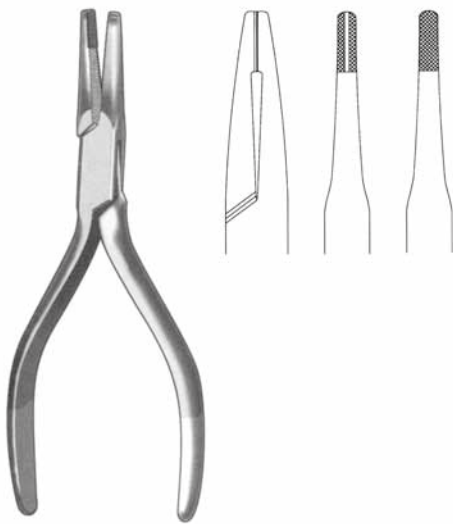

PIN PULLER
34536-03
14 cm, 5 1/2"

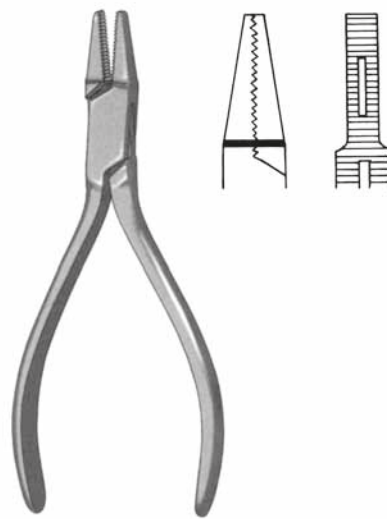

34536-05
14 cm, 5 1/2"

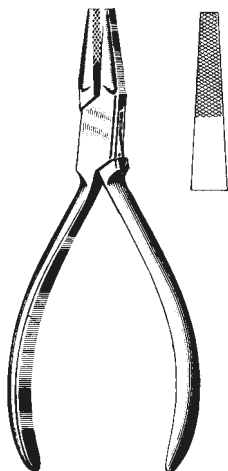

34536-14
14 cm, 5 1/2"

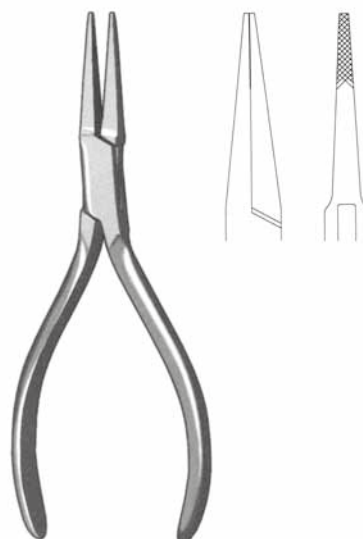

34536-15
15 cm, 6"

Flachzangen, Faßzangen
 Flat Nose Pliers, Seizing Forceps
 Alicates planos, Pinzas para coger alambres
 Tenaglie piate, Tenaglie per afferrare



34537-14
 14 cm, 5 1/2"

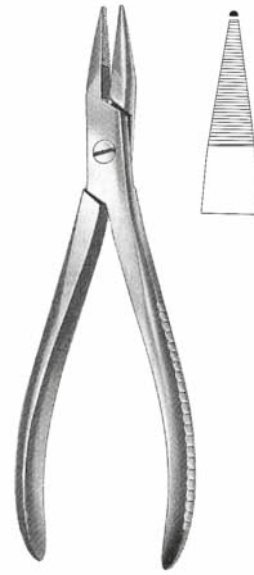

34537-19
 19 cm, 7 1/2"



18 cm, 7"

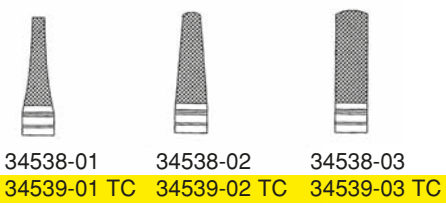

Flachzangen, Drahtkneifzangen
 Flat Nose Pliers, Wire cutting Pliers
 Alicates planos, Alicates para cortar alambre
 Tenaglie piatte, Tenaglie tagliafili



34540-01



34540-02



17 cm, 6 3/4"

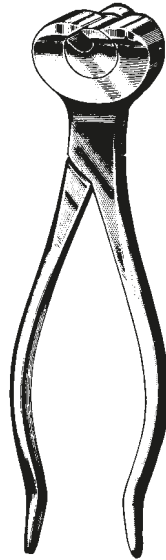

34540-16
 16 cm, 6 1/4"

soft wire 2,0 mm
 hard wire 2,0 mm

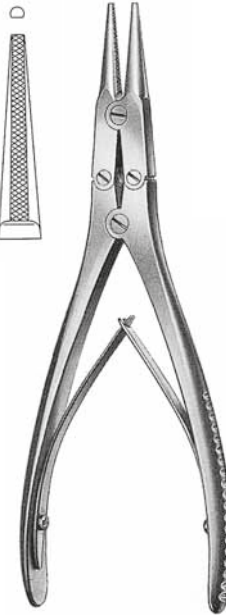

34540-18
 18 cm, 7"

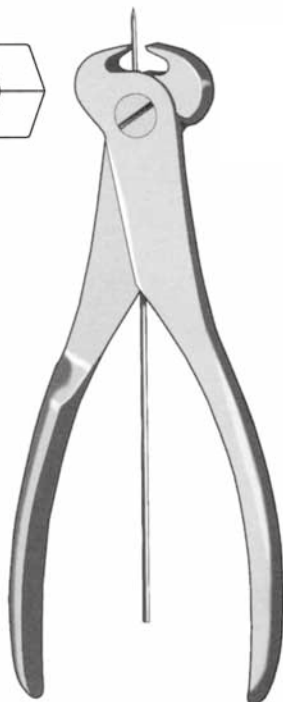

34540-19
 18 cm, 7"

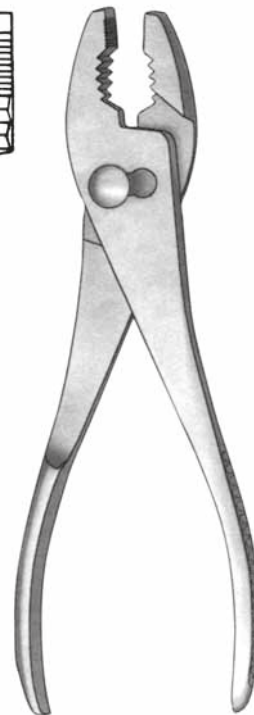

34540-20
 20 cm, 8"

Flachzangen, Drahtkneifzangen
Flat Nose Pliers, Wire cutting Pliers
Alicates planos, Alicates para cortar alambre
Tenaglie piate, Tenaglie tagliafili



34541-23 23 cm, 9"

soft wire 3,0 mm
hard wire 2,2 mm

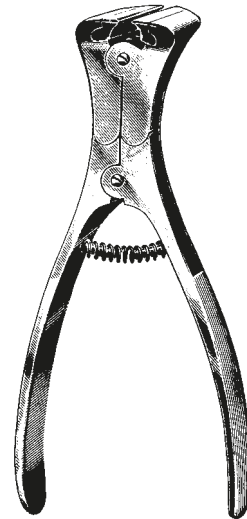

34542-15 TC 15 cm, 6"

Soft wire 2,0 mm
hard wire 1,5 mm



34543-23 23 cm, 9"

Soft wire 3,5 mm
hard wire 2,5 mm

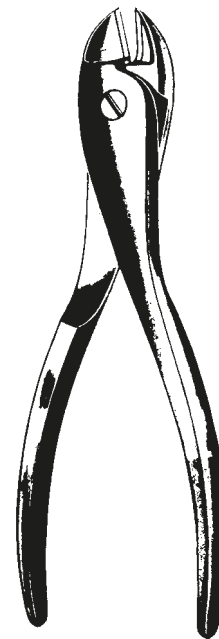

34544-18 TC 18 cm, 7"

Soft wire 2,5 mm
hard wire 1,5 mm

Drahtkneifzangen, Drahtfaßzangen
Wire Cutting Pliers, Wire Seizing Forceps
Alicates para cortar alambre, Pinzas para coger alambre
Tronchese taglienti, Tenaglie per afferrare i fili

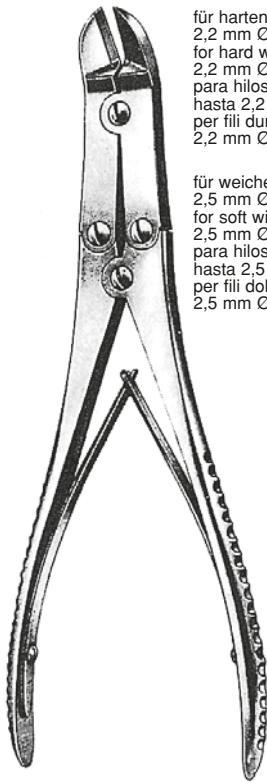

für harten Draht bis
2,2 mm Ø
for hard wires up to
2,2 mm Ø
para hilos duros
hasta 2,2 mm Ø
per fili duri a
2,2 mm Ø

für weichen Draht bis
2,5 mm Ø
for soft wires up to
2,5 mm Ø
para hilos blandos
hasta 2,5 mm Ø
per fili dolci fino a
2,5 mm Ø

34545-22 TC 22 cm, 10 1/2"

für harten Draht bis 1,6 mm Ø
for hard wires up to 1,6 mm Ø
para hilos duros hasta 1,6 mm Ø
per fili duri a 1,6 mm Ø

für weichen Draht bis 2,0 mm Ø
for soft wires up to 2,0 mm Ø
para hilos blandos hasta 2,0 mm Ø
per fili dolci fino a 2,0 mm Ø

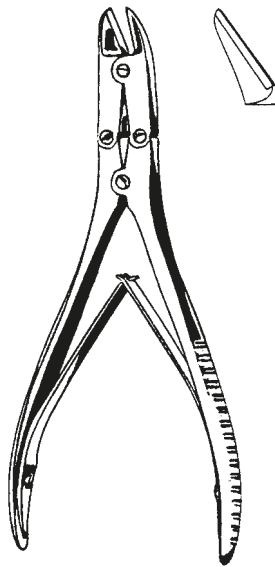

34546-16 16 cm, 6 1/4"
34546-18 18 cm, 7"

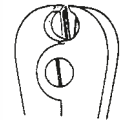

für weichen Draht bis
2,0 mm Ø
for soft wires up to
2,0 mm Ø
para hilos blandos
hasta 2,0 mm Ø
per fili dolci fino a
2,0 mm Ø

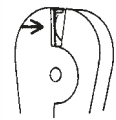

für harten Draht bis
1,6 mm Ø
for hard wires up to
1,6 mm Ø
para hilos duros
hasta 1,6 mm Ø
per fili duri a
1,6 mm Ø

34548-18 18 cm, 7"



soft wire 1,5 mm
hard wire 1,0 mm

34549-14 14 cm, 5 1/2"



34550-13 13 cm, 5 1/8"
34550-18 18 cm, 7"

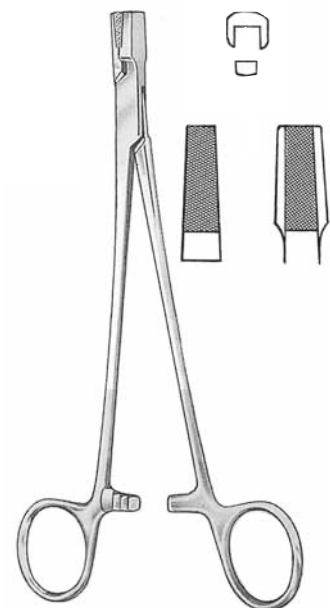

34551-17 17 cm, 6 3/4"

Drahtzangen
Wire Twisting Forceps
Pinzas para torcer hilos
Pinza torcifili

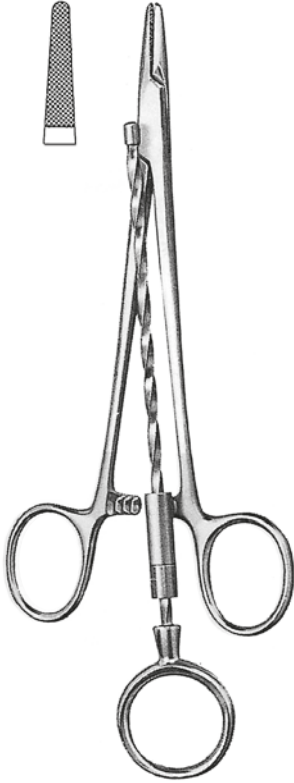

CORWIN-HEGAR
34552-16 TC 16 cm, 6 1/4"



BERRY
34556-18 TC 18 cm, 7"



MAYO-HABERISSER
TC

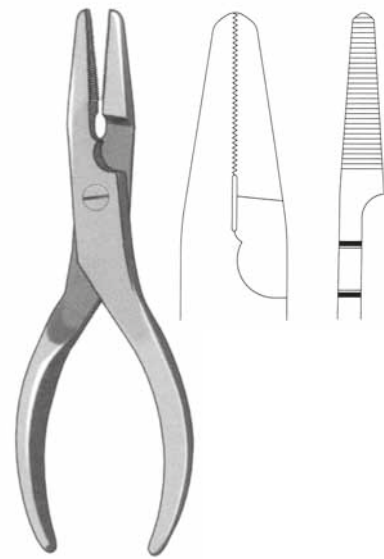
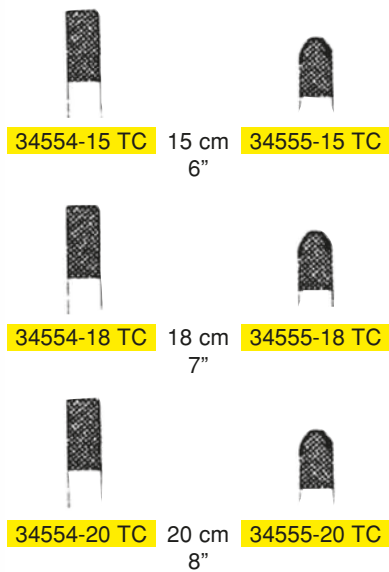

34557-16
16,5 cm, 6 1/2"

Drahtkneifzange für Draht bis 6 mm Ø
Pin cutter for pins up to 6 mm
Alicate para cortar clavos hasta 6 mm
Ghigliottina per tagliare fili fino a 6 mm



34557-30 30 cm, 11 3/4"



34557-25 25 cm, 10"



34557-22 22 cm, 8 3/4"



34558-32 32 cm, 12 1/2"

bis 2.2 mm
up to 2.2 mm
hasta 2.2 mm
a 2.2 mm



34559-47 47 cm, 18 1/2"

bis 6 mm
up to 6 mm
hasta 6 mm
a 6 mm

Drahtkneifzange für Draht bis 6 mm Ø
 Pin cutter for pins up to 6 mm
 Alicates para cortar clavos hasta 6 mm
 Ghigliottina per tagliare fili fino a 6 mm



34560-57 57 cm 22 1/2"

bis 6.5 mm
 up to 6.5 mm
 hasta 6.5 mm
 a 6.5 mm

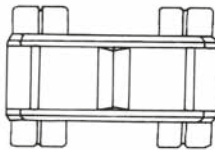
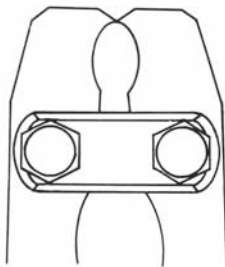

34561-25
 25 cm, 10"

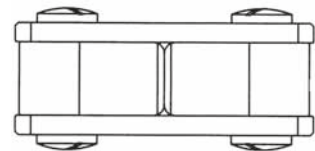
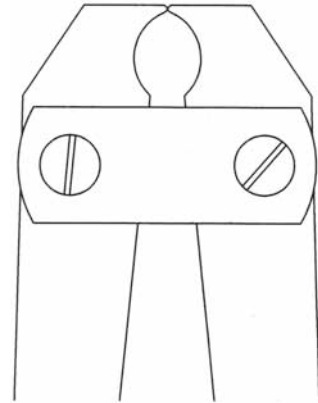

34561-38
 41 cm, 16"
 für Draht bis 7 mm ø

Instrumentarium für Ender und Küntscher Nägel
 Instruments for ender and Küntscher Nails
 Instrumental para Clavos Ender y Küntscher
 Strumentario per chiodi di Ender e Küntscher



KÜNTSCHER 26 cm, 10 1/4"
 34570-01 8 mm Tibia
 34570-02 10 mm Femur

Vorböhrer zum Öffnen der Markhöhle
 Reamers for medullary cave
 Perforadores para la cavidad medular
 Alesatore per l'apertura del midollo



KÜNTSCHER
 34573-35 35 cm, 13 3/4"
 Aufreiber für Oberschenkel
 Reamer for femur
 Perforador para fémur
 Alesatore per femore



mm Ø	L = 60 cm
3,0	34582-60
3,5	34583-60
4,0	34584-60
5,0	34585-60

34581-35 - 34585-60
 Führungsspieße
 Guide pins
 Guía-conductora para clavos medulares
 Guida conduttrice



34578-24
 Guide Rod 2,4 mm,
 length 90 cm
 34578-30
 Guide Rod 3,0 mm,
 length 90 cm



34579-20
 Guide Rod 2,0 mm,
 length 90 cm
 34579-30
 Guide Rod 3,0 mm,
 length 90 cm



für Nägel
 for nails
 para clavos
 per chiodi

Ø 6-8 mm
 34588-01

Ø 9-12 mm
 34588-02

Ø 12-17 mm
 34588-03

KUENTSCHER 19 cm, 7 1/2"

Fertigschläger
 Nail impactors
 Impactor final
 Impattatore finale

Instrumentarium für Nägel
 Instruments for Nails
 Instrumental para Clavos
 Strumentario per chiodi



KÜNTSCHER 63 cm, 24 3/4"
 34590-00 komplett mit 2 Haken 34590-01/02
 34590-00 complete with 2 hooks 34590-01/02
 34590-00 completo con 2 ganchos 34590-01/02
 34590-00 completo con 2 ganci 34590-01/02



34592-00
 Extraktor
 Ender

Extraktionshaken
 Extraction hooks
 Ganchos extractores
 Gancio d'estrazione

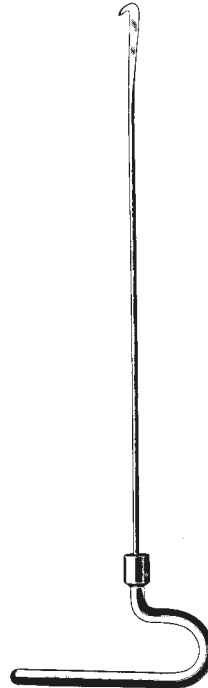

cm
 34596-29 29, 11.4"
 34596-37 37, 14.5"
 34596-42 42, 16.5"
 34596-49 49, 19.3"

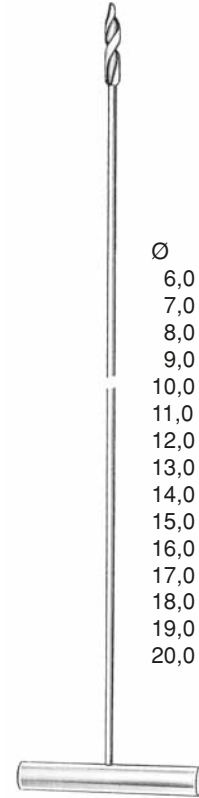

Markraumborher
 Intramedullary drills
 Perforadores medulares
 Perforatore intramidollare

Ø	Part Number
6,0 mm	34597-06
7,0 mm	34597-07
8,0 mm	34597-08
9,0 mm	34597-09
10,0 mm	34597-10
11,0 mm	34597-11
12,0 mm	34597-12
13,0 mm	34597-13
14,0 mm	34597-14
15,0 mm	34597-15
16,0 mm	34597-16
17,0 mm	34597-17
18,0 mm	34597-18
19,0 mm	34597-19
20,0 mm	34597-20

Extraktor / Nail extractor
 Aparato extractor / Estrattore



Einschläger / Nail Inserter
 Introducitor clavos / Impattore
 34612-00



Impactor
 34613-00



Bender
 34615-00



Impactor-Extractor
 Impattore-Estrattore
 34617-00

Schraubenzieher
Screw Drivers
Destornilladores
Cacciaviti



LANE
34620-25 25 cm, 10"
Schraubenzieher 6 mm
Screw Driver 6 mm
Destornillador 6 mm
Cacciaviti 6 mm



WILLIAMS
24 cm
9 1/2"

3,5 mm



34624-01



34624-02



34624-03



34624-04



mit Ferrozellgriff
with Ferrozell handle
con mango de Ferrozell
con manico di Ferrozell



34627-01
17 cm
6 3/4"



34628-02
25 cm
10"



34629-01
20 cm
8"

34628-01
25 cm
10"

34629-02
25 cm
10"



1,5 mm
34628-15
20 cm
8"



1,75 mm
34628-17
20 cm
8"



2,5 mm
34628-25
20 cm
8"



3,5 mm
34628-35
20 cm
8"



4,5 mm
34628-45
20 cm
8"

34629-25
25 cm
10"

34629-35
25 cm
10"

Schraubenzieher
Screw Drivers
Destornilladores
Cacciaviti



34630-15
Screw holder
1,5 mm



34630-25
Screw holder
2,5 mm



LANE
34632-25 25 cm, 10"
Kreuzschlitzschraubenzieher
Screwdriver for cross slotted head
Destornillador para tornillos con ranura en cruz
Cacciavite a croce

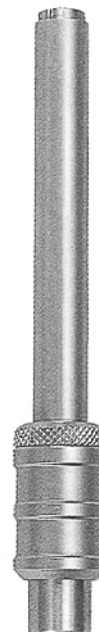

Schraubenhaltehülse für Sechskantschrauben
Screw holder
Vaina para tornillos
Guaina per viti esagonali
34634-25 2,5 mm
34634-35 3,5 mm

Schraubenzieher
Screw Driver
Destornilladores
Cacciaviti



34634-40

T-Handgriff mit Kardangeln SW 11
Giravite esagonale con manico palmare con articolazione cardanica
Mango en T con articulación cardan SW 11



34634-50

Kardangeln-Schraubenzieher 3,5 mm
Sechskant mit Hartgewebegriff
Chiave cardanica inox per viti 3,5 mm
Esagonali
Destornillador con articulación cardan 3.5 mm
Adaptador-destornillador hexagonal con cierre rápido



Schraubenzieher-Einsatz
Sechskant mit Schnellkupplung
Giravite per viti esagondi attacco rapido

34635-15	1,5 mm
34635-25	2,5 mm
34635-35	3,5 mm



34636-10

Mini-Schraubenzieher 1,5 mm Sechskant mit Mini-Schnellkupplung für Dental
Mini giravite esagonale per viti 1,5 mm con attacco rapido esagonale
Mini-destornillador 1.5 mm hexagonal con cierre rápido "dental"



34636-20

Mini-Kreuzschlitz-Schraubenzieher-Einsatz mit Mini-Schnellkupplung für Dental
Mini giravite per viti testa a croce con attacco rapido
Mini-destornillador con ranura en forma de cruz con cierre rápido "dental"

Haltezangen
Holding Forceps
Pinzas para sostener placas
Pinza porta placca

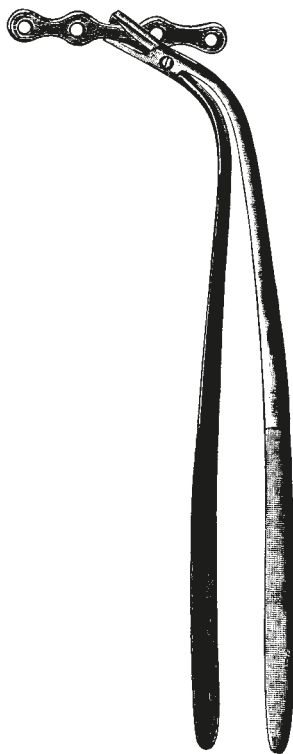

LANE
34637-23 23 cm, 9"

Knochenplatten-Haltezange
Plate Holding Forceps
Pinza para sostener placas
Pinza fermo placche



LANE
34639-22 22 cm, 8 ³/₄"

Schraubenthaltezange
Screw Holding Forceps
Pinza para sostener tornillos
Pinza fermo viti

Biegehebel
Plate Bender
Palanca para placas
Leva piega placche



LANE
34640-18 18 cm, 7"

Biegehebel für Knochenplatten
Plate Bender
Palanca para doblar placas
Leva piega placche



34641-01

Bending Irons for
small plates to be
used as a pair



34641-02

Bending Irons for
small plates to be
used as a pair



34642-01

Bending Iron for
Mini Plates

Biegepresse
Bending press
Pensa de mesa
Pressa piega placche

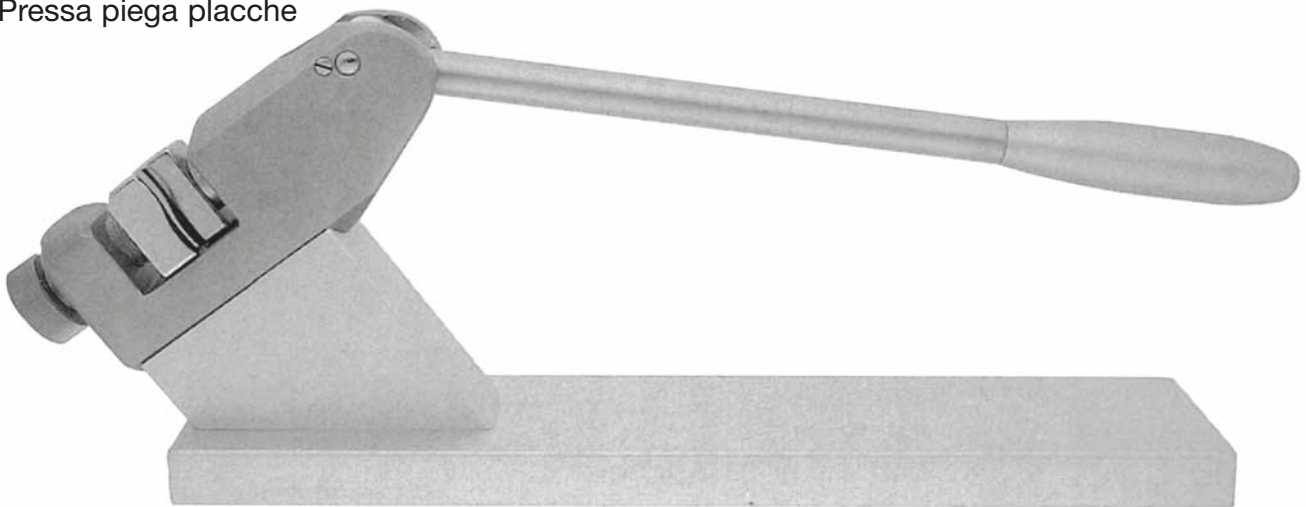

34649-00
Bending Device to bend
straight and angled plates

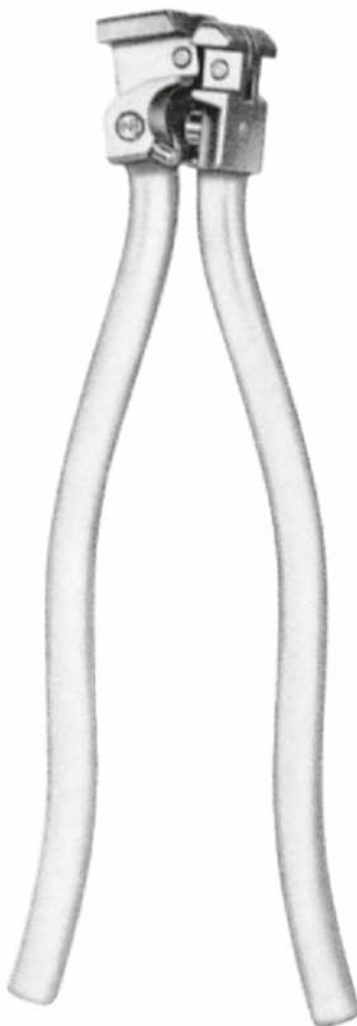

34648-22
Bending Pliers for
2.7 and 3.5 mm plates



34701-01 1,5 - 2,7 mm screws
34701-02 3,5 - 6,5 mm screws
Screw forceps

Kopfraumfräser
Countersink
Avellanador
Fresa per seda sferica



34805-45
Large Countersink
for 4.5 mm and 6.5 diam Screws
Tip 4.5 mm



34806-11
Mini Countersink
for 1.5 mm Screws 2.00 mm
Diam Tip 1.1 mm



34806-20
Small Countersink
for 2.7, 3.5 mm and 4.0 mm
Screws Tip 2.0 mm









34806-32
Malleolar Countersink
Tip 3.2 mm

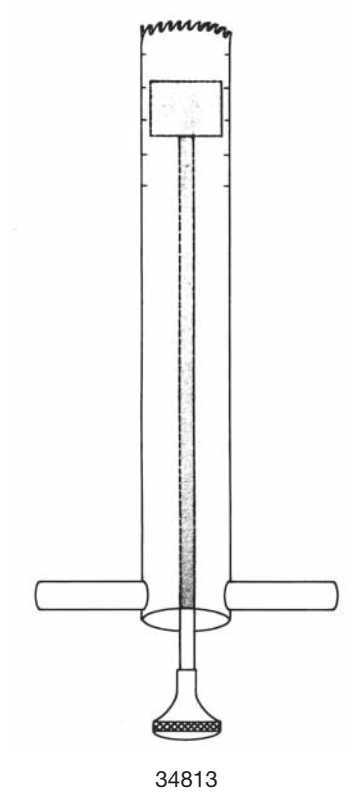

Reamer
34807-20
9 cm, 3 1/2"
Ø 4,0 mm

Trephine
 Trephine
 Trepano
 Punta trapano



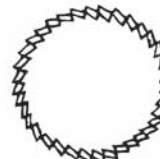

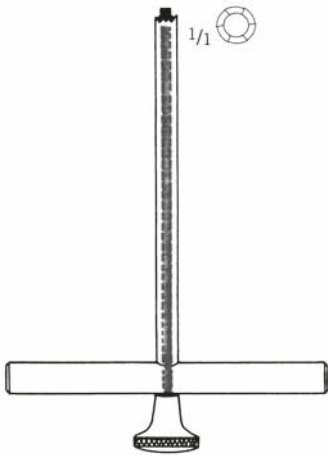

- | | |
|-----------------------------------------------------------------------------------|------------------------------------------------------------------------------------|
|  |  |
| 5/7 mm Ø
34813-05 | 7/9 mm Ø
34813-07 |
|  |  |
| 10/12 mm Ø
34813-10 | 12/14 mm Ø
34813-12 |
|  |  |
| 20/22 mm Ø
34813-20 | 22/24 mm Ø
34813-22 |

34813

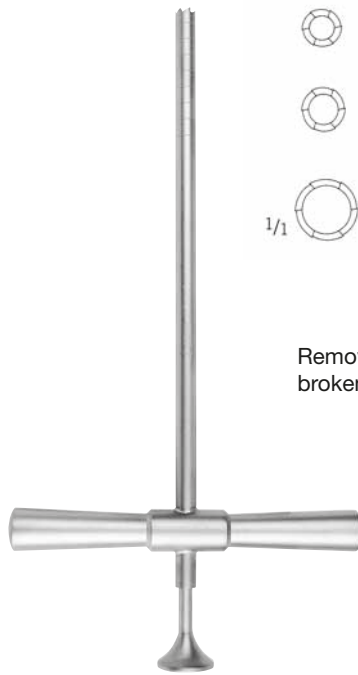

Plug Cutter
 34814-03
 11,5 cm, 4 1/2"



- | | |
|---------------------------------------------------------------------------------------|----------------------|
|  | 3/5 mm Ø
34815-03 |
|  | 4/5 mm Ø
34815-04 |
|  | 6/8 mm Ø
34815-06 |

Removal of
 broken bone screw

Michele Trephine

Gewebeschutzhülse / Bohrbüchse
Soft tissue sleeve / Drill bit guide
Guia de broca
Guida per frese / Guida da punta



34822-15
Mini Drill Sleeve for 1.1 mm and 1.5 mm drill bits



34822-65
Drill Guide for 6.5 mm Screws Drill Bit 3.2 mm



34823-20
Drill Guide and drill sleeve for 2.0 mm drill bit

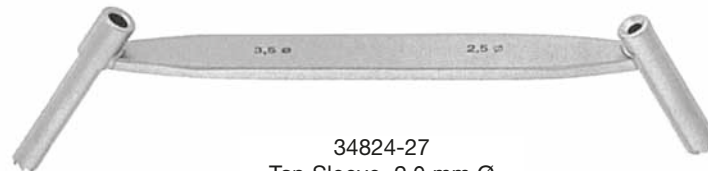

34824-27
Tap Sleeve, 2.0 mm Ø
Drill Sleeve, 2.7 mm Ø



34824-35
Tap Sleeve, 2.5 mm Ø
Drill Sleeve, 3.5 mm Ø

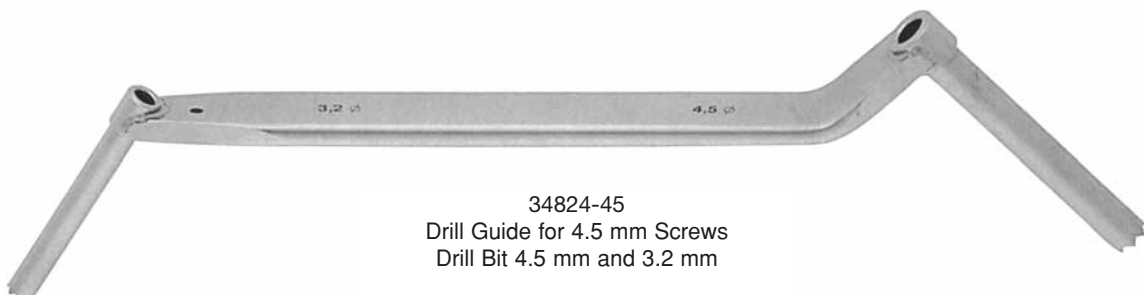

34824-45
Drill Guide for 4.5 mm Screws
Drill Bit 4.5 mm and 3.2 mm

Gewebeschutzhülse / Bohrbüchse
Soft tissue sleeve / Drill bit guide
Guia de broca
Guida per frese / Guida da punta



34825-35
Tap Sleeve
3.5 mm also for
used as 3.2 mm
drill Guide



34825-45
Tap Sleeve
4.5 mm



34826-40
Drill sleeve
3.2 mm for Round
Hole Plates

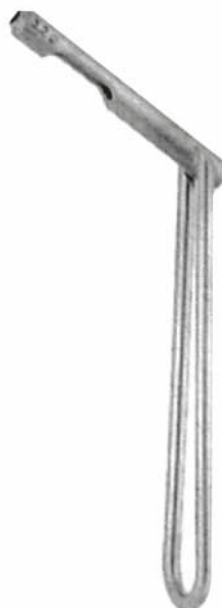

Drill bit sleeve
34826-60
13 cm, 5"
Ø 3,2 mm

Gewebeschutzhülse / Bohrbüchse
Soft tissue sleeve / Drill bit guide
Guia de broca
Guida per frese / Guida da punta



34827-27
Insert Drill Sleeve 2.7 / 2.0 mm
Drill Bit 2.0 mm
34827-35
Insert Drill Sleeve 3.5 / 2.5 mm
Drill Bit 2.5 mm
34827-45
Insert Drill Sleeve 4.5 / 3.2 mm
Drill Bit 3.2 mm



34828-45
C - Clamp Drill Guide
with thread for
Drill Bit 4.5 mm



34829-35
Small Pointed Drill
for Drill Bit 3.5 mm



34829-45
Pointed Drill Guide
6.5 mm

Gewebeschutzhülse / Bohrbüchse
Soft tissue sleeve / Drill bit guide
Guia de broca
Guida per frese / Guida da punta

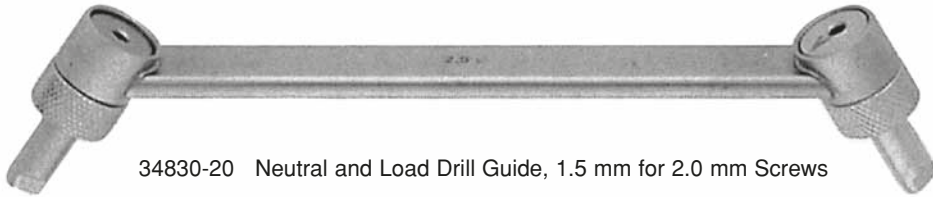

34830-20 Neutral and Load Drill Guide, 1.5 mm for 2.0 mm Screws

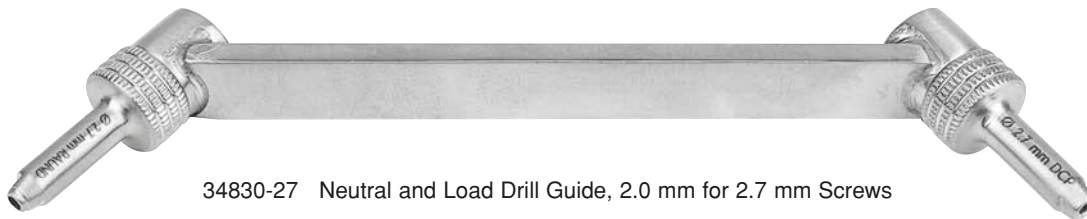

34830-27 Neutral and Load Drill Guide, 2.0 mm for 2.7 mm Screws

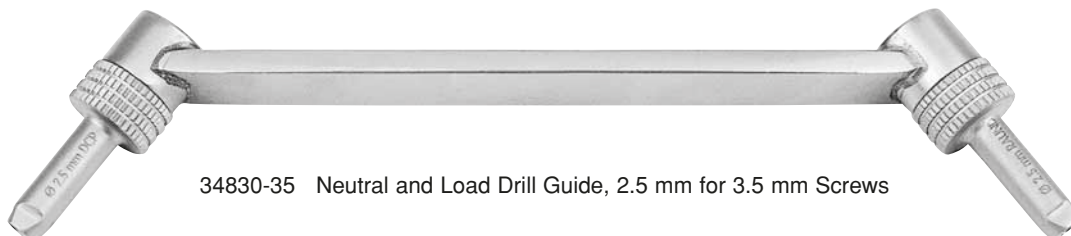

34830-35 Neutral and Load Drill Guide, 2.5 mm for 3.5 mm Screws

Gewebeschutzhülse / Bohrbüchse
Soft tissue sleeve / Drill bit guide
Guia de broca
Guida per frese / Guida da punta

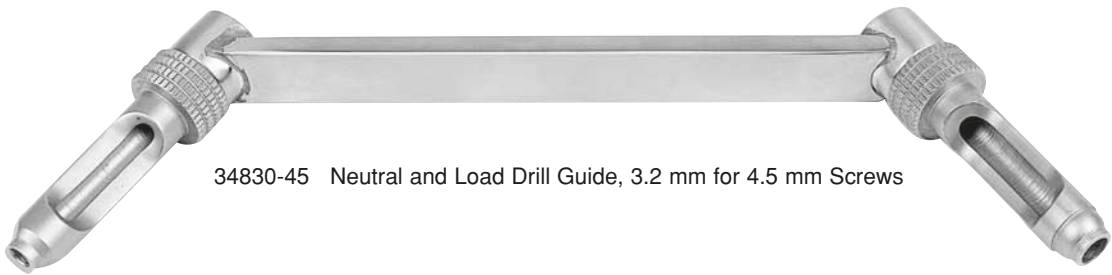

34830-45 Neutral and Load Drill Guide, 3.2 mm for 4.5 mm Screws

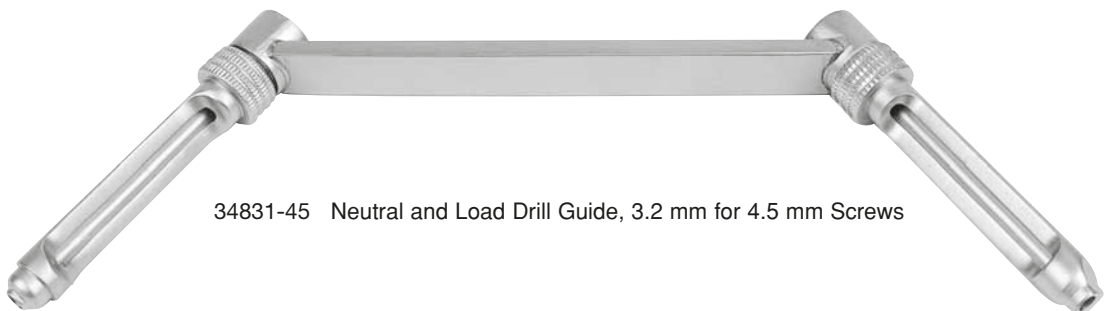

34831-45 Neutral and Load Drill Guide, 3.2 mm for 4.5 mm Screws

Zielgerät / Biegeschablone / Tiefenlehre
 Aiming device / Bending template / Depth gauge
 Guia de perforación / Plantilla maleable / Mediador
 Mirino / Placche malleabili / Profondimetro



Target device
 34832-00
 16 cm, 6 1/4"
 Ø 4,5 mm



34833-32
 Drill Sleeve for
 Tension Device



Bending Template
 Size 4.5 mm 3.5 mm
 5 hole 34835-05 34836-05
 7 hole 34835-07 34836-07
 9 hole 34835-09 34836-09



34850-03 Depth Gauge for 1.5 mm and 2.0 mm screws
 34850-05 Depth Gauge for 2.7 mm and 4.0 mm screws
 34850-10 Depth Gauge for 4.5 mm and 6.5 mm screws 100 mm
 34850-12 Depth Gauge for 4.5 mm and 6.5 mm screws 120 mm

Instrumentarium für Winkelplatten
Instruments for angled plates
Instrumental para placas angolados
Strumentario per palacche angolate



Chisel Guide
34860-00
8 cm, 3 1/4"



Inserter-Extractor for Adult
34861-27
27 cm, 10 1/2"



Impactor
34865-21
20,5 cm, 8 1/2"



Seating Chisel for Children
34863-25
25 cm, 10"



Seating Chisel for Infants
34863-26
26 cm, 10 1/2"



Seating Chisel for Adult
34863-32
32 cm, 12 1/2"

Plattenspanner
Plate tensioner
Tensor de placas
Tenditore di placche

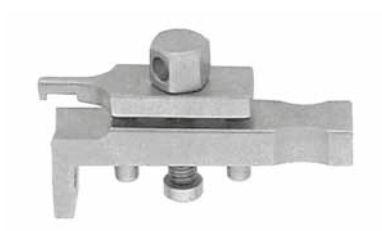

34862-08
8 mm screw-type
Compression Device



34864-20
Articulated Tension Device with Indicator,
span 20 mm may also be used for distraction
of standard and small plate



34864-99
Pin Wrench for Tension
Device and Distactor

Gewindeschneider
Tap
Terraia p torn
Maschio per vite



durchbohrt
cannulated
canulado
cannulato

3,5 mm 34874-35
4,5 mm 34874-45
7,0 mm 34874-70



durchbohrt
cannulated
canulado
cannulato

34875-25



mit Ferrozellgriff
with Ferrozell handle
con mango de Ferrozell
con manico di Ferrozell



3,5 mm

34875-35
20 cm
8"



5,0 mm

34875-50
20 cm
8"

durchbohrt
cannulated
canulado
cannulato

34876-35
25 cm
10"

Zubehör für Winkelplatten
Accessories for angled plates
Accesorios para placas anguladas
Accessori per placche angolate



Triangular Positioning Plates
34852-08
90° - 70° - 30°

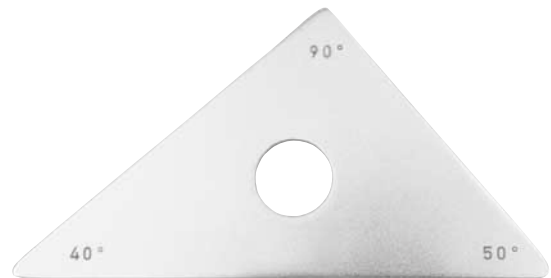

Triangular Positioning Plates
34852-09
90° - 50° - 40°



Triangular Positioning Plates
34852-10
100° - 60° - 20°

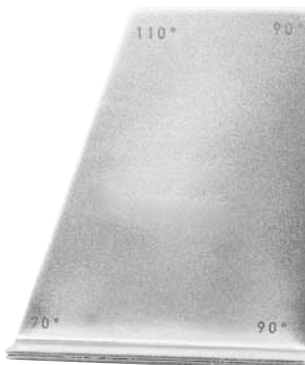

Quadrangular Positioning Plate
34852-11
90° - 50° - 40°



Condylar Plate Guide
34853-09
90° - 50° - 40°

Markraumbohrer flexibel
Flexible Medullary reamer
Taladio flexible intramedular
Fresa flexible

Flexible Medullary Reamer (Hudson Drive Connection)



Ø mm	6,0 37047-060H	6,5 37047-065H	7,0 37047-070H	7,5 37047-075H	8,0 37047-080H	8,5 37047-085H	9,0 37047-090H	9,5 37047-095H
Ø mm	10,0 37047-100H	10,5 37047-105H	11,0 37047-110H	11,5 37047-115H	12,0 37047-120H	12,5 37047-125H	13,0 37047-130H	13,5 37047-135H
Ø mm	14,0 37047-140H	14,5 37047-145H	15,0 37047-150H	15,5 37047-155H	16,0 37047-160H	16,5 37047-165H	17,0 37047-170H	17,5 37047-175H
Ø mm	18,0 37047-180H							

Flexible Medullary Reamer (Aesculap Drive Connection DIN 58809)



Ø mm	6,0 37048-060ST	6,5 37048-065ST	7,0 37048-070ST	7,5 37048-075ST	8,0 37048-080ST	8,5 37048-085ST	9,0 37048-090ST	9,5 37048-095ST
Ø mm	10,0 37048-100ST	10,5 37048-105ST	11,0 37048-110ST	11,5 37048-115ST	12,0 37048-120ST	12,5 37048-125ST	13,0 37048-130ST	13,5 37048-135ST
Ø mm	14,0 37048-140ST	14,5 37048-145ST	15,0 37048-150ST	15,5 37048-155ST	16,0 37048-160ST	16,5 37048-165ST	17,0 37048-170ST	17,5 37048-175ST
Ø mm	18,0 37048-180ST							

Zubehör für Smith Peterson Nägel
Accessories for Smith Peterson nails
Accesorios para tornillos Smith Peterson
Accessori per viti Smith Peterson



RITCHEY
37058-21
21 cm, 8 1/4"



37059-16
16 cm, 6 1/4"

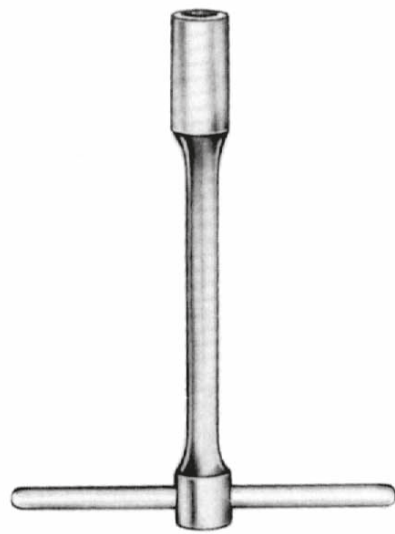

T-Handle
37061-00

Zubehör für Smith Peterson Nägel
Accessories for Smith Peterson nails
Accesorios para tornillos Smith Peterson
Accessori per viti Smith Peterson



37074-00
Impactor-Extractor



37075-00
Impactor-Extractor



37076-00
Impactor-Extractor
Lloyd



37077-00
Nail Starter

Zubehör für dynamische Hüftschrauben
 Implements for dynamic Hip Screws
 Accesorios para tornillos dinámicos
 Accessori per viti dinamiche



Angled Drill Guide for DCS Plates 95°
 37057-00



Measuring Device
 Complete View



Measuring Device
 37092-00
 21 cm, 8 1/4"



Guide Pin
 Ø 2,5 x 230 mm
 10 mm Thread
 37092-23



DCS Triple Reamer
 37094-25
 21 cm, 8 1/4"



DHS Triple Reamer
 37094-38
 21 cm, 8 1/4"

Zubehör für dynamische Hüftschrauben
 Implements for dynamic Hip Screws
 Accesorios para tornillos dinámicos
 Accessori per viti dinamiche



Coupling
Device
Complete View



Coupling
Screw
37095-41
21,5 cm, 8 1/2"



Guide
Shaft
37095-42
20 cm, 8"



Guide Sleeve Long
Complete View

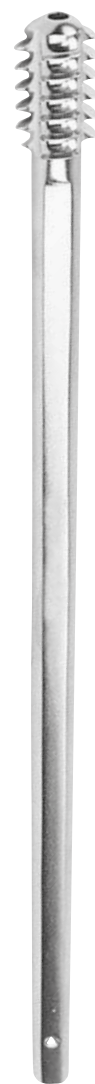

Tap
23 cm, 9"
37096-42



DMS Guide
Sleeve Short
Ø 11 mm
37096-43
11 cm, 4 3/8"

Zubehör für dynamische Hüftschrauben
Implements for dynamic Hip Screws
Accesorios para tornillos dinámicos
Accessori per viti dinamiche



Angled Guide for DHS
37056-35 135°
37056-40 140°
37056-45 145°
37056-50 150°



Trocar Kirschner Wire
Ø 2,5 x 230 mm
37092-23
23 cm, 9"

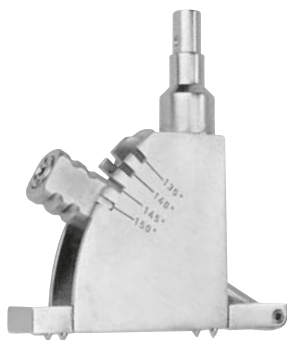

Drill Guide for DHS
37093-00
135° - 150°



Impactor
37095-40
21 cm, 8 1/4"

Zubehör für dynamische Hüftschrauben
Implements for dynamic Hip Screws
Accesorios para tornillos dinámicos
Accessori per viti dinamiche



Guide Sleeve Long
Complete View
25 cm, 10"



Coupling Screw
37095-43
21,5 cm, 8 1/2"



Wrench Screw
37095-44



DHS Guide
Sleeve Long
37096-45



T-Handle with Chuck
37096-00
12 cm, 4 3/4"

Zubehör für Knochenklammern
Implements for Bone Staples
Accesorios para Cambre
Accessori per Grapas

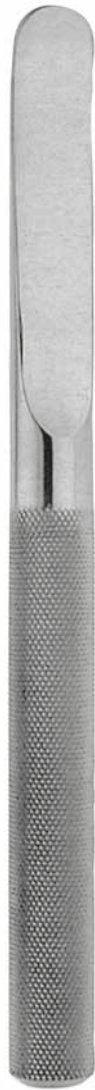

37100-18
Extractor



37100-20
Impactor

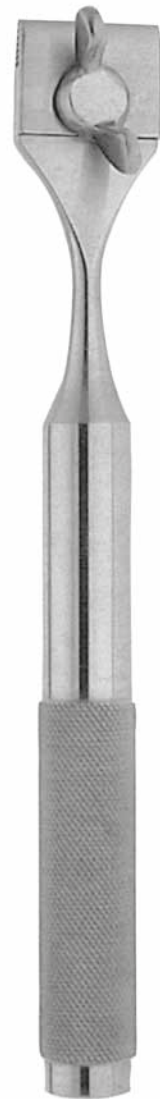

37100-22
Driver

Zubehör Marknägel
Accessories intramedullary nails
Accesorios para intramedular clavo
Accessori per intramedular chiodo

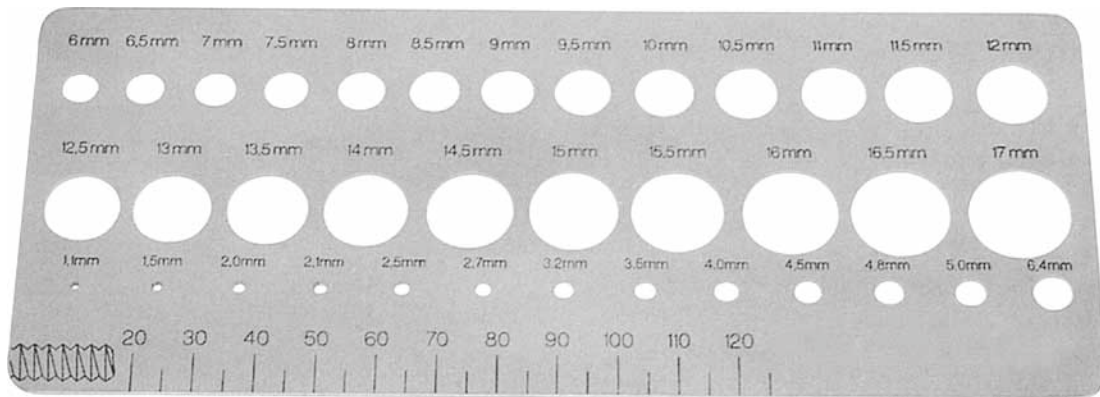

37300-00
Meßlehre / Measuring Device / calibrador / calibre



- 37300-64 Rack for Rush Medullary Set pin 6,4 Ø
- 37300-48 Rack for Rush Medullary Set pin 4,8 Ø
- 37300-32 Rack for Rush Medullary Set pin 3,2 Ø
- 37300-24 Rack for Rush Medullary Set pin 2,4 Ø

Instrumentarium für Rush Marknägel
 Instruments for Rush intramedullary pins
 Instrumental para clavo gancho
 Strumentario per chiodo gancio



37301-64 Rush Awl. Reamer 6,4 Ø
 37301-48 Rush Awl. Reamer 4,8 Ø
 37301-32 Rush Awl. Reamer 3,2 Ø
 37301-24 Rush Awl. Reamer 2,4 Ø



37302-64 Driver and Extractor 6,4 Ø
 37302-48 Driver and Extractor 4,8 Ø
 37302-32 Driver and Extractor 3,2 Ø
 37302-24 Driver and Extractor 2,4 Ø

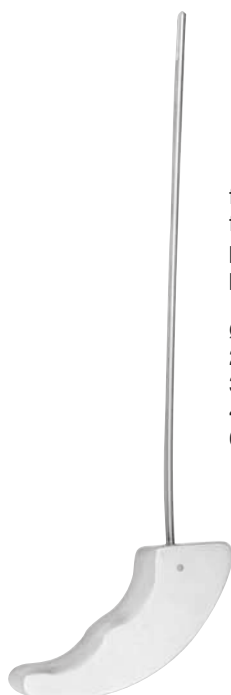

für Nägel
 for nails
 para clavos
 per chiodi

Ø
 2,4 mm 37304-24
 3,2 mm 37304-32
 4,8 mm 37304-48
 6,4 mm 37304-64



Bender
 37305-24
 24 cm

Gigli Säge
Gigli saw
Gigli sierra
Gigli sega

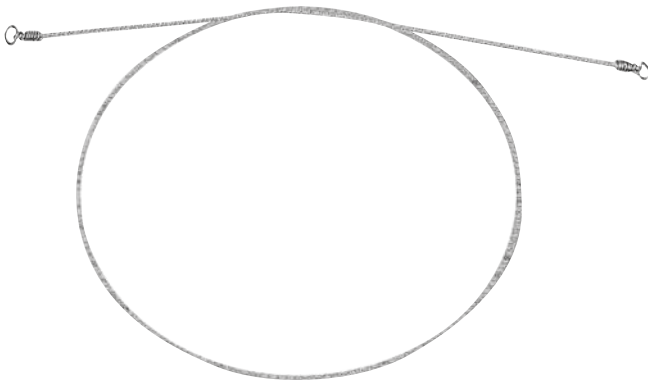

Gigli Saw
41092-30 30 mm
41092-40 40 mm
41092-50 50 mm

For cutting hard bone in difficult cutting situations or locations.
Round tooth design cuts in all directions.



Gigli Saw Handle
41094-00

Special handle for Gigli Saw.
Supplied pair.



41095-00

Special handle for Gigli Saw.
Supplied pair.





1.5

Minifragments Cortical Screws 1.5 mm

Minifragment Kortikalisschrauben 1.5 mm

Mini vis corticales 1.5 mm

1.5 ø Mini Cortical Screws: To be used in interfragmental compression in strong cortical bone of the metatarsals, metacarpals and proximal phalanx. Buttress thread from provides enhanced pull-out resistance in cortical bone. Also used for fixation of mini fragment plates.

Material: Certified Stainless Steel according to ASTM F.138 - ISO 5832/1. Certified Titanium alloy according to ASTM F.136 - ISO 5832/3.

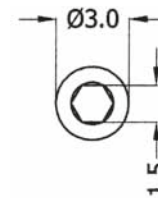

Thread diam.	1.5	1.5	1.5	1.5
Core diam.	1.1	1.1	1.1	1.1
Pitch	0.5	0.5	0.5	0.5
Head diam.	3.0	3.0	3.0	3.0
Hex. Socket	1.5	1.5	1.5	1.5
	Stainless Steel	Stainless Steel Self-Tapping	Titanium	Titanium Self-Tapping
Length mm				
6	ROT-101-006	ROT-101-006 S	ROT-101-006 T	ROT-101-006 TS
7	ROT-101-007	ROT-101-007 S	ROT-101-007 T	ROT-101-007 TS
8	ROT-101-008	ROT-101-008 S	ROT-101-008 T	ROT-101-008 TS
9	ROT-101-009	ROT-101-009 S	ROT-101-009 T	ROT-101-009 TS
10	ROT-101-010	ROT-101-010 S	ROT-101-010 T	ROT-101-010 TS
11	ROT-101-011	ROT-101-011 S	ROT-101-011 T	ROT-101-011 TS
12	ROT-101-012	ROT-101-012 S	ROT-101-012 T	ROT-101-012 TS
14	ROT-101-014	ROT-101-014 S	ROT-101-014 T	ROT-101-014 TS
16	ROT-101-016	ROT-101-016 S	ROT-101-016 T	ROT-101-016 TS
18	ROT-101-018	ROT-101-018 S	ROT-101-018 T	ROT-101-018 TS
20	ROT-101-020	ROT-101-020 S	ROT-101-020 T	ROT-101-020 TS
22	ROT-101-022	ROT-101-022 S	ROT-101-022 T	ROT-101-022 TS
24	ROT-101-024	ROT-101-024 S	ROT-101-024 T	ROT-101-024 TS

Minifragments Cortical Screws 2.0 mm

Minifragment Kortikalisschrauben 2.0 mm

Mini vis corticales 2.0 mm

2.0 ø Mini Cortical Screws: To be used in interfragmental compression in strong cortical bone of the metatarsals, metacarpals and proximal phalanx. Buttress thread from provides enhanced pull-out resistance in cortical bone. Also used for fixation of mini fragment plates.

Material: Certified Stainless Steel according to ASTM F.138 - ISO 5832/1. Certified Titanium alloy according to ASTM F.136 - ISO 5832/3.



2.0

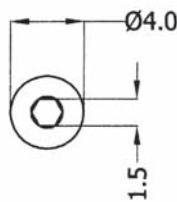

Thread diam.	2.0	2.0	2.0	2.0
Core diam.	1.3	1.3	1.3	1.3
Pitch	0.6	0.6	0.6	0.6
Head diam.	4.0	4.0	4.0	4.0
Hex. Socket	1.5	1.5	1.5	1.5
	Stainless Steel	Stainless Steel Self-Tapping	Titanium	Titanium Self-Tapping
Length mm				
6	ROT-102-006	ROT-102-006 S	ROT-102-006 T	ROT-102-006 TS
8	ROT-102-008	ROT-102-008 S	ROT-102-008 T	ROT-102-008 TS
10	ROT-102-010	ROT-102-010 S	ROT-102-010 T	ROT-102-010 TS
12	ROT-102-012	ROT-102-012 S	ROT-102-012 T	ROT-102-012 TS
14	ROT-102-014	ROT-102-014 S	ROT-102-014 T	ROT-102-014 TS
16	ROT-102-016	ROT-102-016 S	ROT-102-016 T	ROT-102-016 TS
18	ROT-102-018	ROT-102-018 S	ROT-102-018 T	ROT-102-018 TS
20	ROT-102-020	ROT-102-020 S	ROT-102-020 T	ROT-102-020 TS
22	ROT-102-022	ROT-102-022 S	ROT-102-022 T	ROT-102-022 TS
24	ROT-102-024	ROT-102-024 S	ROT-102-024 T	ROT-102-024 TS
26	ROT-102-026	ROT-102-026 S	ROT-102-026 T	ROT-102-026 TS
28	ROT-102-028	ROT-102-028 S	ROT-102-028 T	ROT-102-028 TS
30	ROT-102-030	ROT-102-030 S	ROT-102-030 T	ROT-102-030 TS
32	ROT-102-032	ROT-102-032 S	ROT-102-032 T	ROT-102-032 TS
34	ROT-102-034	ROT-102-034 S	ROT-102-034 T	ROT-102-034 TS
36	ROT-102-036	ROT-102-036 S	ROT-102-036 T	ROT-102-036 TS
38	ROT-102-038	ROT-102-038 S	ROT-102-038 T	ROT-102-038 TS



2.7

Small Fragments Cortical Screws 2.7 mm

Kleinfragment Kortikalisschrauben 2.7 mm

Petites vis corticales 2.7 mm

2.7 ø Small Fragments Cortical Screws: To be used in interfragmental compression in strong cortical bone of the metatarsals, metacarpals and proximal phalanx. Also used for fixation of special mini plates for hand and for foot surgery. Including quarter tubular plates and mini self-compression plates.

Material: Certified Stainless Steel according to ASTM F.138 - ISO 5832/1. Certified Titanium alloy according to ASTM F.136 - ISO 5832/3.

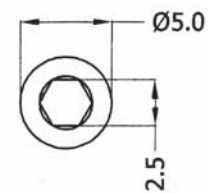

Thread diam.	2.7	2.7	2.7	2.7
Core diam.	1.9	1.9	1.9	1.9
Pitch	1.0	1.0	1.0	1.0
Head diam.	5.0	5.0	5.0	5.0
Hex. Socket	2.5	2.5	2.5	2.5
	Stainless Steel	Stainless Steel Self-Tapping	Titanium	Titanium Self-Tapping
Length mm				
6	ROT-103-006	ROT-103-006 S	ROT-103-006 T	ROT-103-006 TS
8	ROT-103-008	ROT-103-008 S	ROT-103-008 T	ROT-103-008 TS
10	ROT-103-010	ROT-103-010 S	ROT-103-010 T	ROT-103-010 TS
12	ROT-103-012	ROT-103-012 S	ROT-103-012 T	ROT-103-012 TS
14	ROT-103-014	ROT-103-014 S	ROT-103-014 T	ROT-103-014 TS
16	ROT-103-016	ROT-103-016 S	ROT-103-016 T	ROT-103-016 TS
18	ROT-103-018	ROT-103-018 S	ROT-103-018 T	ROT-103-018 TS
20	ROT-103-020	ROT-103-020 S	ROT-103-020 T	ROT-103-020 TS
22	ROT-103-022	ROT-103-022 S	ROT-103-022 T	ROT-103-022 TS
24	ROT-103-024	ROT-103-024 S	ROT-103-024 T	ROT-103-024 TS
26	ROT-103-026	ROT-103-026 S	ROT-103-026 T	ROT-103-026 TS
28	ROT-103-028	ROT-103-028 S	ROT-103-028 T	ROT-103-028 TS
30	ROT-103-030	ROT-103-030 S	ROT-103-030 T	ROT-103-030 TS
32	ROT-103-032	ROT-103-032 S	ROT-103-032 T	ROT-103-032 TS
34	ROT-103-034	ROT-103-034 S	ROT-103-034 T	ROT-103-034 TS
36	ROT-103-036	ROT-103-036 S	ROT-103-036 T	ROT-103-036 TS
38	ROT-103-038	ROT-103-038 S	ROT-103-038 T	ROT-103-038 TS
40	ROT-103-040	ROT-103-040 S	ROT-103-040 T	ROT-103-040 TS
42	ROT-103-042	ROT-103-042 S	ROT-103-042 T	ROT-103-042 TS
44	ROT-103-044	ROT-103-044 S	ROT-103-044 T	ROT-103-044 TS
46	ROT-103-046	ROT-103-046 S	ROT-103-046 T	ROT-103-046 TS
48	ROT-103-048	ROT-103-048 S	ROT-103-048 T	ROT-103-048 TS
50	ROT-103-050	ROT-103-050 S	ROT-103-050 T	ROT-103-050 TS

Small fragments Cortical Screws 3.5 mm

Kleinfragment Kortikalisschrauben 3.5 mm

Petites vis corticales 3.5 mm

3.5 ø Small Fragments Cortical Screws: To be used in interfragmental compression in strong cortical bone of the metatarsals, metacarpals and proximal phalanx. Also used for fixation of special mini plates for hand and for foot surgery. Including quarter tubular plates and mini self-compression plates.

Material: Certified Stainless Steel according to ASTM F.138 - ISO 5832/1. Certified Titanium alloy according to ASTM F.136 - ISO 5832/3.

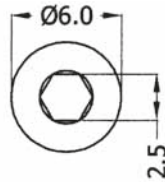

3.5

Thread diam.	3.5	3.5	3.5	3.5
Core diam.	2.4	2.4	2.4	2.4
Pitch	1.25	1.25	1.25	1.25
Head diam.	6.0	6.0	6.0	6.0
Hex. Socket	2.5	2.5	2.5	2.5
	Stainless Steel	Stainless Steel Self-Tapping	Titanium	Titanium Self-Tapping
Length mm				
10	ROT-104-010	ROT-104-010 S	ROT-104-010 T	ROT-104-010 TS
12	ROT-104-012	ROT-104-012 S	ROT-104-012 T	ROT-104-012 TS
14	ROT-104-014	ROT-104-014 S	ROT-104-014 T	ROT-104-014 TS
16	ROT-104-016	ROT-104-016 S	ROT-104-016 T	ROT-104-016 TS
18	ROT-104-018	ROT-104-018 S	ROT-104-018 T	ROT-104-018 TS
20	ROT-104-020	ROT-104-020 S	ROT-104-020 T	ROT-104-020 TS
22	ROT-104-022	ROT-104-022 S	ROT-104-022 T	ROT-104-022 TS
24	ROT-104-024	ROT-104-024 S	ROT-104-024 T	ROT-104-024 TS
26	ROT-104-026	ROT-104-026 S	ROT-104-026 T	ROT-104-026 TS
28	ROT-104-028	ROT-104-028 S	ROT-104-028 T	ROT-104-028 TS
30	ROT-104-030	ROT-104-030 S	ROT-104-030 T	ROT-104-030TS
32	ROT-104-032	ROT-104-032 S	ROT-104-032 T	ROT-104-032 TS
34	ROT-104-034	ROT-104-034 S	ROT-104-034 T	ROT-104-034 TS
36	ROT-104-036	ROT-104-036 S	ROT-104-036 T	ROT-104-036 TS
38	ROT-104-038	ROT-104-038 S	ROT-104-038 T	ROT-104-038 TS
40	ROT-104-040	ROT-104-040 S	ROT-104-040 T	ROT-104-040 TS
45	ROT-104-045	ROT-104-045 S	ROT-104-045 T	ROT-104-045 TS
50	ROT-104-050	ROT-104-050 S	ROT-104-050 T	ROT-104-050 TS
55	ROT-104-055	ROT-104-055 S	ROT-104-055 T	ROT-104-055 TS
60	ROT-104-060	ROT-104-060 S	ROT-104-060 T	ROT-104-060 TS
65	ROT-104-065	ROT-104-065 S	ROT-104-065 T	ROT-104-065 TS
70	ROT-104-070	ROT-104-070 S	ROT-104-070 T	ROT-104-070 TS
75	ROT-104-075	ROT-104-075 S	ROT-104-075 T	ROT-104-075 TS
80	ROT-104-080	ROT-104-080 S	ROT-104-080 T	ROT-104-080 TS
85	ROT-104-085	ROT-104-085 S	ROT-104-085 T	ROT-104-085 TS
90	ROT-104-090	ROT-104-090 S	ROT-104-090 T	ROT-104-090 TS
95	ROT-104-095	ROT-104-095 S	ROT-104-095 T	ROT-104-095 TS
100	ROT-104-100	ROT-104-100 S	ROT-104-100 T	ROT-104-100 TS
105	ROT-104-105	ROT-104-105 S	ROT-104-105 T	ROT-104-105 TS
110	ROT-104-110	ROT-104-110 S	ROT-104-110 T	ROT-104-110 TS



3.5

Cancellous Screws 3.5 mm

Spongiosa Schrauben 3.5 mm

Petites vis corticales 3.5 mm

3.5 ø Cancellous Screws: Fully threaded screw with fine thread (pitch 1.75 mm) for use in interfragmental compression in small cancellous bone and small plate fixation. Available with thread pitch 1.75 mm. Twist drill recommended: Ø 2.5 mm

Material: Certified Stainless Steel according to ASTM F.138 - ISO 5832/1. Certified Titanium alloy according to ASTM F.136 - ISO 5832/3.

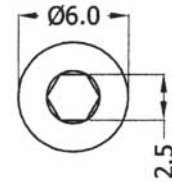

Thread diam.	3.5	3.5
Core diam.	2.0	2.0
Pitch	1.75	1.75
Head diam.	6.0	6.0
Hex. Socket	2.5	2.5
	Stainless Steel	Titanium
Length mm		
10	ROT-105-010	ROT-105-010 T
12	ROT-105-012	ROT-105-012 T
14	ROT-105-014	ROT-105-014 T
16	ROT-105-016	ROT-105-016 T
18	ROT-105-018	ROT-105-018 T
20	ROT-105-020	ROT-105-020 T
22	ROT-105-022	ROT-105-022 T
24	ROT-105-024	ROT-105-024 T
26	ROT-105-026	ROT-105-026 T
28	ROT-105-028	ROT-105-028 T
30	ROT-105-030	ROT-105-030 T
32	ROT-105-032	ROT-105-032 T
34	ROT-105-034	ROT-105-034 T
36	ROT-105-036	ROT-105-036 T
38	ROT-105-038	ROT-105-038 T
40	ROT-105-040	ROT-105-040 T
42	ROT-105-042	ROT-105-042 T
44	ROT-105-044	ROT-105-044 T
46	ROT-105-046	ROT-105-046 T
48	ROT-105-048	ROT-105-048 T
50	ROT-105-050	ROT-105-050 T
55	ROT-105-055	ROT-105-055 T
60	ROT-105-060	ROT-105-060 T

Cancellous Screws 4.0 mm

Spongiosa Schrauben 4.0 mm

Petites vis corticales 4.0 mm

4.0 ø Cancellous Screws: Fully threaded screws for use in interfragmental compression in small cancellous bone. Not to be used as lag screw. But partially threaded screw for use as lag screw in fragment fixation. Deep buttress thread from provides enhanced pull-out resistance. Used in conjunction with one-third tubular plates and other small plates.

Material: Certified Stainless Steel according to ASTM F.138 - ISO 5832/1. Certified Titanium alloy according to ASTM F.136 - ISO 5832/3.



4.0

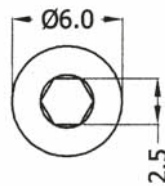

Thread diam.	4.0	4.0	4.0	4.0
Core diam.	2.0	2.0	2.0	2.0
Pitch	1.75	1.75	1.75	1.75
Head diam.	6.0	6.0	6.0	6.0
Hex. Socket	2.5	2.5	2.5	2.5
	Stainless Steel Full Thread	Stainless Steel Short Thread	Titanium Full Thread	Titanium Short Thread
Length mm				
10	ROT-106-010	ROT-107-010	ROT-106-010 T	ROT-107-010 T
12	ROT-106-012	ROT-107-012	ROT-106-012 T	ROT-107-012 T
14	ROT-106-014	ROT-107-014	ROT-106-014 T	ROT-107-014 T
16	ROT-106-016	ROT-107-016	ROT-106-016 T	ROT-107-016 T
18	ROT-106-018	ROT-107-018	ROT-106-018 T	ROT-107-018 T
20	ROT-106-020	ROT-107-020	ROT-106-020 T	ROT-107-020 T
22	ROT-106-022	ROT-107-022	ROT-106-022 T	ROT-107-022 T
24	ROT-106-024	ROT-107-024	ROT-106-024 T	ROT-107-024 T
26	ROT-106-026	ROT-107-026	ROT-106-026 T	ROT-107-026 T
28	ROT-106-028	ROT-107-028	ROT-106-028 T	ROT-107-028 T
30	ROT-106-030	ROT-107-030	ROT-106-030 T	ROT-107-030 T
32	ROT-106-032	ROT-107-032	ROT-106-032 T	ROT-107-032 T
34	ROT-106-034	ROT-107-034	ROT-106-034 T	ROT-107-034 T
35	ROT-106-035	ROT-107-035		
36	ROT-106-036	ROT-107-036	ROT-106-036 T	ROT-107-036 T
38	ROT-106-038	ROT-107-038	ROT-106-038 T	ROT-107-038 T
40	ROT-106-040	ROT-107-040	ROT-106-040 T	ROT-107-040 T
42	ROT-106-042	ROT-107-042	ROT-106-042 T	ROT-107-042 T
44	ROT-106-044	ROT-107-044	ROT-106-044 T	ROT-107-044 T
46	ROT-106-046	ROT-107-046	ROT-106-046 T	ROT-107-046 T
48	ROT-106-048	ROT-107-048	ROT-106-048 T	ROT-107-048 T
50	ROT-106-050	ROT-107-050	ROT-106-050 T	ROT-107-050 T
55	ROT-106-055	ROT-107-055	ROT-106-055 T	ROT-107-055 T
60	ROT-106-060	ROT-107-060	ROT-106-060 T	ROT-107-060 T



4.5

Large fragments Cortical Screws 4.5 mm

Grossfragment Kortikalisschrauben 4.5 mm

Grandes vis à corticales 4.5 mm

Thread diam.	4.5	4.5
Core diam.	3.0	3.0
Pitch	1.75	1.75
Head diam.	8.0	8.0
Hex. Socket	3.5	3.5

	Stainless Steel	Titanium
Length mm		
14	ROT-108-014	ROT-108-014 T
16	ROT-108-016	ROT-108-016 T
18	ROT-108-018	ROT-108-018 T
20	ROT-108-020	ROT-108-020 T
22	ROT-108-022	ROT-108-022 T
24	ROT-108-024	ROT-108-024 T
26	ROT-108-026	ROT-108-026 T
28	ROT-108-028	ROT-108-028 T
30	ROT-108-030	ROT-108-030 T
32	ROT-108-032	ROT-108-032 T
34	ROT-108-034	ROT-108-034 T
36	ROT-108-036	ROT-108-036 T
38	ROT-108-038	ROT-108-038 T
40	ROT-108-040	ROT-108-040 T
42	ROT-108-042	ROT-108-042 T
44	ROT-108-044	ROT-108-044 T
46	ROT-108-046	ROT-108-046 T
48	ROT-108-048	ROT-108-048 T
50	ROT-108-050	ROT-108-050 T
52	ROT-108-052	ROT-108-052 T
54	ROT-108-054	ROT-108-054 T
56	ROT-108-056	ROT-108-056 T
58	ROT-108-058	ROT-108-058 T
60	ROT-108-060	ROT-108-060 T
62	ROT-108-062	ROT-108-062 T
64	ROT-108-064	ROT-108-064 T
66	ROT-108-066	ROT-108-066 T
68	ROT-108-068	ROT-108-068 T
70	ROT-108-070	ROT-108-070 T
72	ROT-108-072	ROT-108-072 T
74	ROT-108-074	ROT-108-074 T
76	ROT-108-076	ROT-108-076 T
78	ROT-108-078	ROT-108-078 T
80	ROT-108-080	ROT-108-080 T
85	ROT-108-085	ROT-108-085 T
90	ROT-108-090	ROT-108-090 T
95	ROT-108-095	ROT-108-095 T
100	ROT-108-100	ROT-108-100 T
105	ROT-108-105	ROT-108-105 T
110	ROT-108-110	ROT-108-110 T
115	ROT-108-115	ROT-108-115 T
120	ROT-108-120	ROT-108-120 T
125	ROT-108-125	ROT-108-125 T
130	ROT-108-130	ROT-108-130 T
135	ROT-108-135	ROT-108-135 T
140	ROT-108-140	ROT-108-140 T

4.5 ø Large Cortical Screws:

Primarily used in interfragmental compression bone plates and used in hard cortical bone where buttress thread form provide enhanced pull-out resistance. Used alone for fragment fixation, including use as a lag screw. Available in self-tapping.

Material: Certified Stainless Steel according to ASTM F.138 - ISO 5832/1. Certified Titanium alloy according to ASTM F.136 - ISO 5832/3.

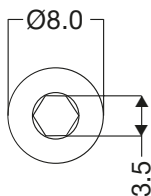

Large fragments Cortical Screws 4.5 mm

Grossfragment Kortikalisschrauben 4.5 mm

Grandes vis à corticales 4.5 mm



4.5

Thread diam.	4.5	4.5
Core diam.	3.0	3.0
Pitch	1.75	1.75
Head diam.	8.0	8.0
Hex. Socket	3.5	3.5
	Stainless Steel Self-Tapping	Titanium Self-Tapping
Length mm		
14	ROT-108-014 S	ROT-108-014 TS
16	ROT-108-016 S	ROT-108-016 TS
18	ROT-108-018 S	ROT-108-018 TS
20	ROT-108-020 S	ROT-108-020 TS
22	ROT-108-022 S	ROT-108-022 TS
24	ROT-108-024 S	ROT-108-024 TS
26	ROT-108-026 S	ROT-108-026 TS
28	ROT-108-028 S	ROT-108-028 TS
30	ROT-108-030 S	ROT-108-030 TS
32	ROT-108-032 S	ROT-108-032 TS
34	ROT-108-034 S	ROT-108-034 TS
36	ROT-108-036 S	ROT-108-036 TS
38	ROT-108-038 S	ROT-108-038 TS
40	ROT-108-040 S	ROT-108-040 TS
42	ROT-108-042 S	ROT-108-042 TS
44	ROT-108-044 S	ROT-108-044 TS
46	ROT-108-046 S	ROT-108-046 TS
48	ROT-108-048 S	ROT-108-048 TS
50	ROT-108-050 S	ROT-108-050 TS
52	ROT-108-052 S	ROT-108-052 TS
54	ROT-108-054 S	ROT-108-054 TS
56	ROT-108-056 S	ROT-108-056 TS
58	ROT-108-058 S	ROT-108-058 TS
60	ROT-108-060 S	ROT-108-060 TS
62	ROT-108-062 S	ROT-108-062 TS
64	ROT-108-064 S	ROT-108-064 TS
66	ROT-108-066 S	ROT-108-066 TS
68	ROT-108-068 S	ROT-108-068 TS
70	ROT-108-070 S	ROT-108-070 TS
72	ROT-108-072 S	ROT-108-072 TS
74	ROT-108-074 S	ROT-108-074 TS
76	ROT-108-076 S	ROT-108-076 TS
78	ROT-108-078 S	ROT-108-078 TS
80	ROT-108-080 S	ROT-108-080 TS
85	ROT-108-085 S	ROT-108-085 TS
90	ROT-108-090 S	ROT-108-090 TS
95	ROT-108-095 S	ROT-108-095 TS
100	ROT-108-100 S	ROT-108-100 TS
105	ROT-108-105 S	ROT-108-105 TS
110	ROT-108-110 S	ROT-108-110 TS
115	ROT-108-115 S	ROT-108-115 TS
120	ROT-108-120 S	ROT-108-120 TS
125	ROT-108-125 S	ROT-108-125 TS
130	ROT-108-130 S	ROT-108-130 TS
135	ROT-108-135 S	ROT-108-135 TS
140	ROT-108-140 S	ROT-108-140 TS

4.5 ø Large Cortical Screws:

Primarily used in interfragmental compression bone plates and used in hard cortical bone where buttress thread form provide enhanced pull-out resistance. Used alone for fragment fixation, including use as a lag screw. Available in self-tapping.

Material: Certified Stainless Steel according to ASTM F.138 - ISO 5832/1. Certified Titanium alloy according to ASTM F.136 - ISO 5832/3.

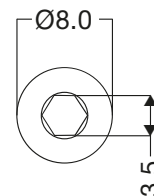



4.5

Large fragments Malleolar Screws 4.5 mm

Grossfragment Malleolarschrauben 4.5 mm

Grandes vis à 4.5 mm

4.5 ø Malleolar Screws: These partially threaded screws are used for the fixation of small fragments in cancellous bone. The head has a hexagonal socket and the screw is inserted by using a screwdriver.

Material: Certified Stainless Steel according to ASTM F.138 - ISO 5832/1. Certified Titanium alloy according to ASTM F.136 - ISO 5832/3.

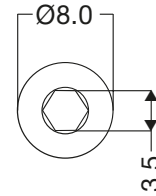

Thread diam.	4.5	4.5
Core diam.	3.0	3.0
Pitch	1.75	1.75
Head diam.	8.0	8.0
Hex. Socket	3.5	3.5
	Stainless Steel	Titanium
Total length		
Thread length		
25	12	ROT-111-025 T
30	15	ROT-111-030 T
35	18	ROT-111-035 T
40	20	ROT-111-040 T
45	22	ROT-111-045 T
50	24	ROT-111-050 T
55	26	ROT-111-055 T
60	28	ROT-111-060 T
65	30	ROT-111-065 T
70	32	ROT-111-070 T
75	34	ROT-111-075 T
80	36	ROT-111-080 T
85	38	ROT-111-085 T
90	40	ROT-111-090 T

Cancellous Screws 6.5 mm

Spongiaschrauben 6.5 mm

Vis spongieuses 6.5 mm

6.5 ø Cancellous Screws: The main indication for using cancellous screws is when the cortex is thinner than 3.5 mm. The short threaded screws (16 mm) are used for fractures of the femoral neck in adolescents; separated epiphysis and for certain fractures of the tibial plateau. The long threaded screws (32 mm) are used for fractures in the vicinity of

joints. The head has a hexagonal socket and the screw is inserted by using screwdriver.

Material: Certified Stainless Steel according to ASTM F.138 - ISO 5832/1. Certified Titanium alloy according to ASTM F.136 - ISO 5832/3.

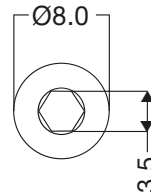

6.5

Thread diam.	6.5	6.5	6.5	6.5
Core diam.	4.5	4.5	4.5	4.5
Pitch	2.75	2.75	2.75	2.75
Head diam.	8.0	8.0	8.0	8.0
Hex. Socket	3.5	3.5	3.5	3.5
	Stainless Steel	Titanium	Stainless Steel	Titanium
	Short Thread 16 mm	Short Thread 16 mm	Thread 32 mm	Thread 32 mm
Length mm				
25	ROT-121-025	ROT-121-025 T		
30	ROT-121-030	ROT-121-030 T		
35	ROT-121-035	ROT-121-035 T		
40	ROT-121-040	ROT-121-040 T		
45	ROT-121-045	ROT-121-045 T	ROT-122-045	ROT-122-045 T
50	ROT-121-050	ROT-121-050 T	ROT-122-050	ROT-122-050 T
55	ROT-121-055	ROT-121-055 T	ROT-122-055	ROT-122-055 T
60	ROT-121-060	ROT-121-060 T	ROT-122-060	ROT-122-060 T
65	ROT-121-065	ROT-121-065 T	ROT-122-065	ROT-122-065 T
70	ROT-121-070	ROT-121-070 T	ROT-122-070	ROT-122-070 T
75	ROT-121-075	ROT-121-075 T	ROT-122-075	ROT-122-075 T
80	ROT-121-080	ROT-121-080 T	ROT-122-080	ROT-122-080 T
85	ROT-121-085	ROT-121-085 T	ROT-122-085	ROT-122-085 T
90	ROT-121-090	ROT-121-090 T	ROT-122-090	ROT-122-090 T
95	ROT-121-095	ROT-121-095 T	ROT-122-095	ROT-122-095 T
100	ROT-121-100	ROT-121-100 T	ROT-122-100	ROT-122-100 T
105	ROT-121-105	ROT-121-105 T	ROT-122-105	ROT-122-105 T
110	ROT-121-110	ROT-121-110 T	ROT-122-110	ROT-122-110 T
115	ROT-121-115	ROT-121-115 T	ROT-122-115	ROT-122-115 T
120	ROT-121-120	ROT-121-120 T	ROT-122-120	ROT-122-120 T
125	ROT-121-125	ROT-121-125 T	ROT-122-125	ROT-122-125 T
130	ROT-121-130	ROT-121-130 T	ROT-122-130	ROT-122-130 T
135	ROT-121-135	ROT-121-135 T	ROT-122-135	ROT-122-135 T
140	ROT-121-140	ROT-121-140 T	ROT-122-140	ROT-122-140 T
145			ROT-122-145	ROT-122-145 T
150			ROT-122-150	ROT-122-150 T



6.5

Cancellous Screws 6.5 mm

Spongiosaschrauben 6.5 mm

Vis spongieuses 6.5 mm

6.5 ø Cancellous Screws: The main indication for using cancellous screws is when the cortex is thinner than 3.5 mm. The short threaded screws (16 mm) are used for fractures of the femoral neck in adolescents; separated epiphysis and for certain fractures of the tibial plateau. The long threaded screws (32 mm) are used for fractures in the vicinity of joints. The head has a hexagonal socket and the screw is inserted by using screwdriver.

Twist drill recommended: Ø 3.2 mm

Material: Certified Stainless Steel according to ASTM F.138 - ISO 5832/1. Certified Titanium alloy according to ASTM F.136 - ISO 5832/3.

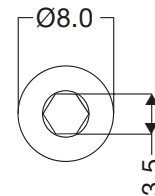

Thread diam.	6.5	6.5
Core diam.	3.0	3.0
Pitch	2.75	2.75
Head diam.	8.0	8.0
Hex. Socket	3.5	3.5
	Stainless Steel Full Thread	Titanium Full Thread
Length mm		
20	ROT-123-020	ROT-123-020 T
25	ROT-123-025	ROT-123-025 T
30	ROT-123-030	ROT-123-030 T
35	ROT-123-035	ROT-123-035 T
40	ROT-123-040	ROT-123-040 T
45	ROT-123-045	ROT-123-045 T
50	ROT-123-050	ROT-123-050 T
55	ROT-123-055	ROT-123-055 T
60	ROT-123-060	ROT-123-060 T
65	ROT-123-065	ROT-123-065 T
70	ROT-123-070	ROT-123-070 T
75	ROT-123-075	ROT-123-075 T
80	ROT-123-080	ROT-123-080 T
85	ROT-123-085	ROT-123-085 T
90	ROT-123-090	ROT-123-090 T
95	ROT-123-095	ROT-123-095 T
100	ROT-123-100	ROT-123-100 T
105	ROT-123-105	ROT-123-105 T
110	ROT-123-110	ROT-123-110 T
115	ROT-123-115	ROT-123-115 T

Cancellous Screws 2.7 mm

Durchbohrte Schrauben 2.7 mm

Vis spongieuses 2.7 mm

2.7 ø Cancellous Screws: The main indication for using cancellous screws is when the cortex is thinner than 3.5 mm.

The short threaded screws are used for fractures of the femoral neck in adolescents; separated epiphysis and for certain fractures of the tibial plateau. The long threaded screws are used for fractures in the vicinity

of joints. The head has a hexagonal socket and the screw is inserted by using screwdriver.

Material: Certified Stainless Steel according to ASTM F.138 - ISO 5832/1. Certified Titanium alloy according to ASTM F.136 - ISO 5832/3.

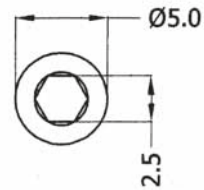

2.7

Thread diam.	2.7	2.7	2.7	2.7
Core diam.	1.9	1.9	1.9	1.9
Pitch	1.0	1.0	1.0	1.0
Head diam.	5.0	5.0	5.0	5.0
Hex. Socket	2.5	2.5	2.5	2.5
Cannulation	1.15	1.15	1.15	1.15
	Stainless Steel	Titanium	Stainless Steel	Titanium
	Short Thread Self-Tapping	Short Thread Self-Tapping	Long Thread Self-Tapping	Long Thread Self-Tapping
Length mm				
8	ROT-125-008 S	ROT-125-008 TS		
9	ROT-125-009 S	ROT-125-009 TS		
10	ROT-125-010 S	ROT-125-010 TS		
11	ROT-125-011 S	ROT-125-011 TS		
12	ROT-125-012 S	ROT-125-012 TS		
13	ROT-125-013 S	ROT-125-013 TS		
14	ROT-125-014 S	ROT-125-014 TS	ROT-127-014 S	ROT-127-014 TS
15	ROT-125-015 S	ROT-125-015 TS	ROT-127-015 S	ROT-127-015 TS
16	ROT-125-016 S	ROT-125-016 TS	ROT-127-016 S	ROT-127-016 TS
17	ROT-125-017 S	ROT-125-017 TS	ROT-127-017 S	ROT-127-017 TS
18	ROT-125-018 S	ROT-125-018 TS	ROT-127-018 S	ROT-127-018 TS
19	ROT-125-019 S	ROT-125-019 TS	ROT-127-019 S	ROT-127-019 TS
20	ROT-125-020 S	ROT-125-020 TS	ROT-127-020 S	ROT-127-020 TS
21	ROT-125-021 S	ROT-125-021 TS	ROT-127-021 S	ROT-127-021 TS
22	ROT-125-022 S	ROT-125-022 TS	ROT-127-022 S	ROT-127-022 TS
23	ROT-125-023 S	ROT-125-023 TS	ROT-127-023 S	ROT-127-023 TS
24	ROT-125-024 S	ROT-125-024 TS	ROT-127-024 S	ROT-127-024 TS
25	ROT-125-025 S	ROT-125-025 TS	ROT-127-025 S	ROT-127-025 TS
26	ROT-125-026 S	ROT-125-026 TS	ROT-127-026 S	ROT-127-026 TS
27	ROT-125-027 S	ROT-125-027 TS	ROT-127-027 S	ROT-127-027 TS
28	ROT-125-028 S	ROT-125-028 TS	ROT-127-028 S	ROT-127-028 TS
29	ROT-125-029 S	ROT-125-029 TS	ROT-127-029 S	ROT-127-029 TS
30	ROT-125-030 S	ROT-125-030 TS	ROT-127-030 S	ROT-127-030 TS
32	ROT-125-032 S	ROT-125-032 TS	ROT-127-032 S	ROT-127-032 TS
34	ROT-125-034 S	ROT-125-034 TS	ROT-127-034 S	ROT-127-034 TS
36	ROT-125-036 S	ROT-125-036 TS	ROT-127-036 S	ROT-127-036 TS
38	ROT-125-038 S	ROT-125-038 TS	ROT-127-038 S	ROT-127-038 TS
40	ROT-125-040 S	ROT-125-040 TS	ROT-127-040 S	ROT-127-040 TS



2.7

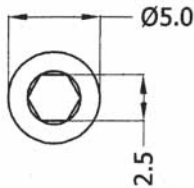

Cancellous Screws 2.7 mm

Durchbohrte Schrauben 2.7 mm

Vis spongieuses 2.7 mm

2.7 ø Cancellous Screws: The main indication for using cancellous screws is when the cortex is thinner than 3.5 mm.

The short threaded screws are used for fractures of the femoral neck in adolescents; separated epiphysis and for certain fractures of the tibial plateau. The long threaded screws are used for fractures in the vicinity

of joints. The head has a hexagonal socket and the screw is inserted by using screwdriver.

Material: Certified Stainless Steel according to ASTM F.138 - ISO 5832/1. Certified Titanium alloy according to ASTM F.136 - ISO 5832/3.

Thread diam.	2.7	2.7
Core diam.	1.9	1.9
Pitch	1.0	1.0
Head diam.	5.0	5.0
Hex. Socket	2.5	2.5
Cannulation	1.15	1.15
	Stainless Steel	Titanium
	Fully Threaded	Fully Threaded
	Self-Tapping	Self-Tapping
Length mm		
10	ROT-126-010 S	ROT-126-010 TS
11	ROT-126-011 S	ROT-126-011 TS
12	ROT-126-012 S	ROT-126-012 TS
13	ROT-126-013 S	ROT-126-013 TS
14	ROT-126-014 S	ROT-126-014 TS
15	ROT-126-015 S	ROT-126-015 TS
16	ROT-126-016 S	ROT-126-016 TS
17	ROT-126-017 S	ROT-126-017 TS
18	ROT-126-018 S	ROT-126-018 TS
19	ROT-126-019 S	ROT-126-019 TS
20	ROT-126-020 S	ROT-126-020 TS
21	ROT-126-021 S	ROT-126-021 TS
22	ROT-126-022 S	ROT-126-022 TS
23	ROT-126-023 S	ROT-126-023 TS
24	ROT-126-024 S	ROT-126-024 TS
25	ROT-126-025 S	ROT-126-025 TS
26	ROT-126-026 S	ROT-126-026 TS
27	ROT-126-027 S	ROT-126-027 TS
28	ROT-126-028 S	ROT-126-028 TS
29	ROT-126-029 S	ROT-126-029 TS
30	ROT-126-030 S	ROT-126-030 TS
32	ROT-126-032 S	ROT-126-032 TS
34	ROT-126-034 S	ROT-126-034 TS
36	ROT-126-036 S	ROT-126-036 TS
38	ROT-126-038 S	ROT-126-038 TS
40	ROT-126-040 S	ROT-126-040 TS

Cancellous Screws 3.5 mm

Durchbohrte Schrauben 3.5 mm

Vis spongieuses 3.5 mm

3.5 ø Cancellous Screws: The main indication for using cancellous screws is when the cortex is thinner than 3.5 mm.

The short threaded screws are used for fractures of the femoral neck in adolescents; separated epiphysis and for certain fractures of the tibial plateau. The long threaded screws are used for fractures in the vicinity of joints. The head has a hexagonal socket and the screw is inserted by using screwdriver.

Material: Certified Stainless Steel according to ASTM F.138 - ISO 5832/1. Certified Titanium alloy according to ASTM F.136 - ISO 5832/3.

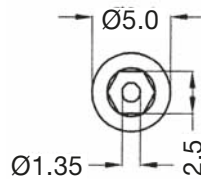

3.5

Thread diam.	3.5	3.5	3.5	3.5
Core diam.	2.5	2.5	2.5	2.5
Pitch	1.25	1.25	1.25	1.25
Head diam.	5.0	5.0	5.0	5.0
Hex. Socket	2.5	2.5	2.5	2.5
Cannulation	1.35	1.35	1.35	1.35
	Stainless Steel	Titanium	Stainless Steel	Titanium
	Short Thread	Short Thread	Fully Threaded	Fully Threaded
	Self-Tapping	Self-Tapping	Self-Tapping	Self-Tapping
Length mm				
10	ROT-129-010 S	ROT-129-010 TS	ROT-128-010 S	ROT-128-010 TS
12	ROT-129-012 S	ROT-129-012 TS	ROT-128-012 S	ROT-128-012 TS
14	ROT-129-014 S	ROT-129-014 TS	ROT-128-014 S	ROT-128-014 TS
16	ROT-129-016 S	ROT-129-016 TS	ROT-128-016 S	ROT-128-016 TS
18	ROT-129-018 S	ROT-129-018 TS	ROT-128-018 S	ROT-128-018 TS
20	ROT-129-020 S	ROT-129-020 TS	ROT-128-020 S	ROT-128-020 TS
22	ROT-129-022 S	ROT-129-022 TS	ROT-128-022 S	ROT-128-022 TS
24	ROT-129-024 S	ROT-129-024 TS	ROT-128-024 S	ROT-128-024 TS
26	ROT-129-026 S	ROT-129-026 TS	ROT-128-026 S	ROT-128-026 TS
28	ROT-129-028 S	ROT-129-028 TS	ROT-128-028 S	ROT-128-028 TS
30	ROT-129-030 S	ROT-129-030 TS	ROT-128-030 S	ROT-128-030 TS
32	ROT-129-032 S	ROT-129-032 TS	ROT-128-032 S	ROT-128-032 TS
34	ROT-129-034 S	ROT-129-034 TS	ROT-128-034 S	ROT-128-034 TS
36	ROT-129-036 S	ROT-129-036 TS	ROT-128-036 S	ROT-128-036 TS
38	ROT-129-038 S	ROT-129-038 TS	ROT-128-038 S	ROT-128-038 TS
40	ROT-129-040 S	ROT-129-040 TS	ROT-128-040 S	ROT-128-040 TS
42	ROT-129-042 S	ROT-129-042 TS	ROT-128-042 S	ROT-128-042 TS
44	ROT-129-044 S	ROT-129-044 TS	ROT-128-044 S	ROT-128-044 TS
46	ROT-129-046 S	ROT-129-046 TS	ROT-128-046 S	ROT-128-046 TS
48	ROT-129-048 S	ROT-129-048 TS	ROT-128-048 S	ROT-128-048 TS
50	ROT-129-050 S	ROT-129-050 TS	ROT-128-050 S	ROT-128-050 TS



4.5

Cancellous Screws 4.5 mm

Durchbohrte Schrauben 4.5 mm

Vis spongieuses 4.5 mm

4.5 ø Cancellous Screws: The main indication for using cancellous screws is when the cortex is thinner than 3.5 mm.

The short threaded screws are used for fractures of the femoral neck in adolescents; separated epiphysis and for certain fractures of the tibial plateau. The long threaded screws are used for fractures in the vicinity of joints. The head has a hexagonal socket and the screw is inserted by using screwdriver.

Material: Certified Stainless Steel according to ASTM F.138 - ISO 5832/1. Certified Titanium alloy according to ASTM F.136 - ISO 5832/3.

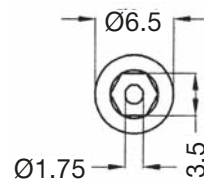

Thread diam.	4.5	4.5	4.5	4.5
Core diam.	3.2	3.2	3.2	3.2
Pitch	1.75	1.75	1.75	1.75
Head diam.	6.5	6.5	6.5	6.5
Hex. Socket	3.5	3.5	3.5	3.5
Cannulation	1.75	1.75	1.75	1.75
	Stainless Steel	Titanium	Stainless Steel	Titanium
	Short Thread	Short Thread	Fully Threaded	Fully Threaded
	Self-Tapping	Self-Tapping	Self-Tapping	Self-Tapping
Length mm				
20	ROT-132-020 S	ROT-132-020 TS	ROT-133-020 S	ROT-133-020 TS
22	ROT-132-022 S	ROT-132-022 TS	ROT-133-022 S	ROT-133-022 TS
24	ROT-132-024 S	ROT-132-024 TS	ROT-133-024 S	ROT-133-024 TS
26	ROT-132-026 S	ROT-132-026 TS	ROT-133-026 S	ROT-133-026 TS
28	ROT-132-028 S	ROT-132-028 TS	ROT-133-028 S	ROT-133-028 TS
30	ROT-132-030 S	ROT-132-030 TS	ROT-133-030 S	ROT-133-030 TS
32	ROT-132-032 S	ROT-132-032 TS	ROT-133-032 S	ROT-133-032 TS
34	ROT-132-034 S	ROT-132-034 TS	ROT-133-034 S	ROT-133-034 TS
36	ROT-132-036 S	ROT-132-036 TS	ROT-133-036 S	ROT-133-036 TS
38	ROT-132-038 S	ROT-132-038 TS	ROT-133-038 S	ROT-133-038 TS
40	ROT-132-040 S	ROT-132-040 TS	ROT-133-040 S	ROT-133-040 TS
42	ROT-132-042 S	ROT-132-042 TS	ROT-133-042 S	ROT-133-042 TS
44	ROT-132-044 S	ROT-132-044 TS	ROT-133-044 S	ROT-133-044 TS
46	ROT-132-046 S	ROT-132-046 TS	ROT-133-046 S	ROT-133-046 TS
48	ROT-132-048 S	ROT-132-048 TS	ROT-133-048 S	ROT-133-048 TS
50	ROT-132-050 S	ROT-132-050 TS	ROT-133-050 S	ROT-133-050 TS
52	ROT-132-052 S	ROT-132-052 TS	ROT-133-052 S	ROT-133-052 TS
54	ROT-132-054 S	ROT-132-054 TS	ROT-133-054 S	ROT-133-054 TS
56	ROT-132-056 S	ROT-132-056 TS	ROT-133-056 S	ROT-133-056 TS
60	ROT-132-060 S	ROT-132-060 TS	ROT-133-060 S	ROT-133-060 TS
64	ROT-132-064 S	ROT-132-064 TS	ROT-133-064 S	ROT-133-064 TS
68	ROT-132-068 S	ROT-132-068 TS	ROT-133-068 S	ROT-133-068 TS
72	ROT-132-072 S	ROT-132-072 TS	ROT-133-072 S	ROT-133-072 TS

Cancellous Screws 7.0 mm

Durchbohrte Schrauben 7.0 mm

Vis spongieuses 7.0 mm

7.0 ø Cancellous Screws: The main indication for using cancellous screws is when the cortex is thinner than 3.5 mm. The short threaded screws (16 mm) are used for fractures of the femoral neck in adolescents; separated epiphysis and for certain fractures of the tibial plateau. The long threaded screws (32 mm) are used for fractures in the vicinity of joints. The head has a hexagonal socket and the screw is inserted by using screwdriver.

Material: Certified Stainless Steel according to ASTM F.138 - ISO 5832/1. Certified Titanium alloy according to ASTM F.136 - ISO 5832/3.

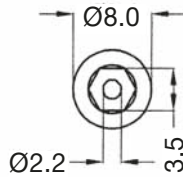

7.0

Thread diam.	7.0	7.0	7.0	7.0
Core diam.	4.4	4.4	4.4	4.4
Pitch	2.75	2.75	2.75	2.75
Head diam.	8.0	8.0	8.0	8.0
Hex. Socket	3.5	3.5	3.5	3.5
Cannulation	2.2	2.2	2.2	2.2
	Stainless Steel	Titanium	Stainless Steel	Titanium
	Short Thread 16 mm	Short Thread 16 mm	Thread 32 mm	Thread 32 mm
	Self-Tapping	Self-Tapping	Self-Tapping	Self-Tapping
Length mm				
25	ROT-135-025 S	ROT-135-025 TS		
30	ROT-135-030 S	ROT-135-030 TS		
35	ROT-135-035 S	ROT-135-035 TS		
40	ROT-135-040 S	ROT-135-040 TS		
45	ROT-135-045 S	ROT-135-045 TS	ROT-136-045 S	ROT-136-045 TS
50	ROT-135-050 S	ROT-135-050 TS	ROT-136-050 S	ROT-136-050 TS
55	ROT-135-055 S	ROT-135-055 TS	ROT-136-055 S	ROT-136-055 TS
60	ROT-135-060 S	ROT-135-060 TS	ROT-136-060 S	ROT-136-060 TS
65	ROT-135-065 S	ROT-135-065 TS	ROT-136-065 S	ROT-136-065 TS
70	ROT-135-070 S	ROT-135-070 TS	ROT-136-070 S	ROT-136-070 TS
75	ROT-135-075 S	ROT-135-075 TS	ROT-136-075 S	ROT-136-075 TS
80	ROT-135-080 S	ROT-135-080 TS	ROT-136-080 S	ROT-136-080 TS
85	ROT-135-085 S	ROT-135-085 TS	ROT-136-085 S	ROT-136-085 TS
90	ROT-135-090 S	ROT-135-090 TS	ROT-136-090 S	ROT-136-090 TS
95	ROT-135-095 S	ROT-135-095 TS	ROT-136-095 S	ROT-136-095 TS
100	ROT-135-100 S	ROT-135-100 TS	ROT-136-100 S	ROT-136-100 TS
105	ROT-135-105 S	ROT-135-105 TS	ROT-136-105 S	ROT-136-105 TS
110	ROT-135-110 S	ROT-135-110 TS	ROT-136-110 S	ROT-136-110 TS
115	ROT-135-115 S	ROT-135-115 TS	ROT-136-115 S	ROT-136-115 TS
120	ROT-135-120 S	ROT-135-120 TS	ROT-136-120 S	ROT-136-120 TS
125	ROT-135-125 S	ROT-135-125 TS	ROT-136-125 S	ROT-136-125 TS
130	ROT-135-130 S	ROT-135-130 TS	ROT-136-130 S	ROT-136-130 TS



7.0

Cancellous Screws 7.0 mm

Durchbohrte Schrauben 7.0 mm

Vis spongieuses 7.0 mm

7.0 ø Cancellous Screws: The main indication for using cancellous screws is when the cortex is thinner than 3.5 mm. The head has a hexagonal socket and the screw is inserted by using screwdriver.

Material: Certified Stainless Steel according to ASTM F.138 - ISO 5832/1. Certified Titanium alloy according to ASTM F.136 - ISO 5832/3.

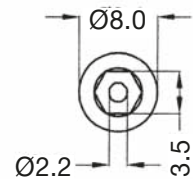

Thread diam.	7.0	7.0
Core diam.	4.4	4.4
Pitch	2.75	2.75
Head diam.	8.0	8.0
Hex. Socket	3.5	3.5
Cannulation	2.2	2.2
	Stainless Steel	Titanium
	Fully Threaded	Fully Threaded
	Self-Tapping	Self-Tapping
Length mm		
25	ROT-137-025 S	ROT-137-025 TS
30	ROT-137-030 S	ROT-137-030 TS
35	ROT-137-035 S	ROT-137-035 TS
40	ROT-137-040 S	ROT-137-040 TS
45	ROT-137-045 S	ROT-137-045 TS
50	ROT-137-050 S	ROT-137-050 TS
55	ROT-137-055 S	ROT-137-055 TS
60	ROT-137-060 S	ROT-137-060 TS
65	ROT-137-065 S	ROT-137-065 TS
70	ROT-137-070 S	ROT-137-070 TS
75	ROT-137-075 S	ROT-137-075 TS
80	ROT-137-080 S	ROT-137-080 TS
85	ROT-137-085 S	ROT-137-085 TS
90	ROT-137-090 S	ROT-137-090 TS
95	ROT-137-095 S	ROT-137-095 TS
100	ROT-137-100 S	ROT-137-100 TS
105	ROT-137-105 S	ROT-137-105 TS
110	ROT-137-110 S	ROT-137-110 TS
115	ROT-137-115 S	ROT-137-115 TS
120	ROT-137-120 S	ROT-137-120 TS
125	ROT-137-125 S	ROT-137-125 TS
130	ROT-137-130 S	ROT-137-130 TS

Cancellous Screws 7.3 mm

Durchbohrte Schrauben 7.3 mm

Vis spongieuses 7.3 mm

7.3 ø Cancellous Screws: The main indication for using cancellous screws is when the cortex is thinner than 3.5 mm. The short threaded screws (16 mm) are used for fractures of the femoral neck in adolescents; separated epiphysis and for certain fractures of the tibial plateau. The long threaded screws (32 mm) are used for fractures in the vicinity of joints. The head has a hexagonal socket and the screw is inserted by using screwdriver.

Material: Certified Stainless Steel according to ASTM F.138 - ISO 5832/1. Certified Titanium alloy according to ASTM F.136 - ISO 5832/3.

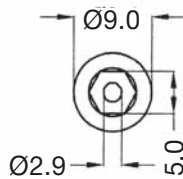

7.3

Thread diam.	7.3	7.3	7.3	7.3
Core diam.	4.8	4.8	4.8	4.8
Pitch	2.75	2.75	2.75	2.75
Head diam.	9.0	9.0	9.0	9.0
Hex. Socket	5.0	5.0	5.0	5.0
Cannulation	2.9	2.9	2.9	2.9
	Stainless Steel	Titanium	Stainless Steel	Titanium
	Short Thread 16 mm	Short Thread 16 mm	Thread 32 mm	Thread 32 mm
	Self-Tapping	Self-Tapping	Self-Tapping	Self-Tapping
Length mm				
30	ROT-138-030 S	ROT-138-030 TS		
35	ROT-138-035 S	ROT-138-035 TS		
40	ROT-138-040 S	ROT-138-040 TS		
45	ROT-138-045 S	ROT-138-045 TS	ROT-139-045 S	ROT-139-045 TS
50	ROT-138-050 S	ROT-138-050 TS	ROT-139-050 S	ROT-139-050 TS
55	ROT-138-055 S	ROT-138-055 TS	ROT-139-055 S	ROT-139-055 TS
60	ROT-138-060 S	ROT-138-060 TS	ROT-139-060 S	ROT-139-060 TS
65	ROT-138-065 S	ROT-138-065 TS	ROT-139-065 S	ROT-139-065 TS
70	ROT-138-070 S	ROT-138-070 TS	ROT-139-070 S	ROT-139-070 TS
75	ROT-138-075 S	ROT-138-075 TS	ROT-139-075 S	ROT-139-075 TS
80	ROT-138-080 S	ROT-138-080 TS	ROT-139-080 S	ROT-139-080 TS
85	ROT-138-085 S	ROT-138-085 TS	ROT-139-085 S	ROT-139-085 TS
90	ROT-138-090 S	ROT-138-090 TS	ROT-139-090 S	ROT-139-090 TS
95	ROT-138-095 S	ROT-138-095 TS	ROT-139-095 S	ROT-139-095 TS
100	ROT-138-100 S	ROT-138-100 TS	ROT-139-100 S	ROT-139-100 TS
105	ROT-138-105 S	ROT-138-105 TS	ROT-139-105 S	ROT-139-105 TS
110	ROT-138-110 S	ROT-138-110 TS	ROT-139-110 S	ROT-139-110 TS
115	ROT-138-115 S	ROT-138-115 TS	ROT-139-115 S	ROT-139-115 TS
120	ROT-138-120 S	ROT-138-120 TS	ROT-139-120 S	ROT-139-120 TS
125	ROT-138-125 S	ROT-138-125 TS	ROT-139-125 S	ROT-139-125 TS
130	ROT-138-130 S	ROT-138-130 TS	ROT-139-130 S	ROT-139-130 TS
135	ROT-138-135 S	ROT-138-135 TS	ROT-139-135 S	ROT-139-135 TS
140	ROT-138-140 S	ROT-138-140 TS	ROT-139-140 S	ROT-139-140 TS
145	ROT-138-145 S	ROT-138-145 TS	ROT-139-145 S	ROT-139-145 TS
150	ROT-138-150 S	ROT-138-150 TS	ROT-139-150 S	ROT-139-150 TS



7.3

Cancellous Screws 7.3 mm

Durchbohrte Schrauben 7.3 mm

Vis spongieuses 7.3 mm

7.3 ø Cancellous Screws: The main indication for using cancellous screws is when the cortex is thinner than 3.5 mm. The short threaded screws (16 mm) are used for fractures of the femoral neck in adolescents; separated epiphysis and for certain fractures of the tibial plateau. The long threaded screws (32 mm) are used for fractures in the vicinity of joints. The head has a hexagonal socket and the screw is inserted by using screwdriver.

Material: Certified Stainless Steel according to ASTM F.138 - ISO 5832/1. Certified Titanium alloy according to ASTM F.136 - ISO 5832/3.

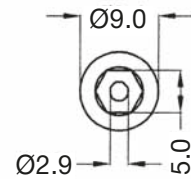

Thread diam.	7.3	7.3
Core diam.	4.8	4.8
Pitch	2.75	2.75
Head diam.	9.0	9.0
Hex. Socket	5.0	5.0
Cannulation	2.9	2.9
	Stainless Steel	Titanium
	Fully Threaded	Fully Threaded
	Self-Tapping	Self-Tapping
Length mm		
25	ROT-140-025 S	ROT-140-025 TS
30	ROT-140-030 S	ROT-140-030 TS
35	ROT-140-035 S	ROT-140-035 TS
40	ROT-140-040 S	ROT-140-040 TS
45	ROT-140-045 S	ROT-140-045 TS
50	ROT-140-050 S	ROT-140-050 TS
55	ROT-140-055 S	ROT-140-055 TS
60	ROT-140-060 S	ROT-140-060 TS
65	ROT-140-065 S	ROT-140-065 TS
70	ROT-140-070 S	ROT-140-070 TS
75	ROT-140-075 S	ROT-140-075 TS
80	ROT-140-080 S	ROT-140-080 TS
85	ROT-140-085 S	ROT-140-085 TS
90	ROT-140-090 S	ROT-140-090 TS
95	ROT-140-095 S	ROT-140-095 TS
100	ROT-140-100 S	ROT-140-100 TS
105	ROT-140-105 S	ROT-140-105 TS
110	ROT-140-110 S	ROT-140-110 TS
115	ROT-140-115 S	ROT-140-115 TS
120	ROT-140-120 S	ROT-140-120 TS
125	ROT-140-125 S	ROT-140-125 TS
130	ROT-140-130 S	ROT-140-130 TS

Herbert Screw Hand system

Herbert Schrauben Hand System

Vis à Herbert

Indication: The Herbert cannulated bone screws has unique design that allows repairs to be made in a manner actually fosters healing.

Material: The Herbert screws is manufactured from titanium Ti6Al4V according to ASTM F.136 - ISO 5832/3. which has been specifically designed for the manufacture of orthopaedic implants. This alloy characterized by demonstrating excellent biocompatibility together with a high resistance of corrosion and superiormechnical strength.



3.0

Ref. No Titanium	Schraubenlänge Screw length mm	Gewindelänge thread length mm
ROT-141-010 T	10	3.30
ROT-141-012 T	12	3.90
ROT-141-014 T	14	4.50
ROT-141-016 T	16	5.10
ROT-141-018 T	18	5.80
ROT-141-020 T	20	6.40
ROT-141-022 T	22	7.00
ROT-141-024 T	24	7.70
ROT-141-026 T	26	8.30
ROT-141-028 T	28	9.00
ROT-141-030 T	30	9.60

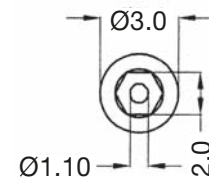



3.0

Herbert Screw Foot system

Herbert Schrauben Fuss System

Vis à Herbert

Indication: The Herbert cannulated bone screws has unique design that allows repairs to be made in a manner actually fosters healing.

Material: The Herbert screws is manufactured from titanium Ti6Al4V according to ASTM F.136 - ISO 5832/3. which has been specifically designed for the manufacture of orthopaedic implants. This alloy characterized by demonstrating excellent biocompatibility together with a high resistance of corrosion and superiormechnical strength.

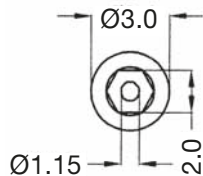

Ref. No Titanium	Schraubenlänge Screw length mm	Gewindelänge thread length mm
ROT-142-010 T	10	5.00
ROT-142-012 T	12	7.00
ROT-142-014 T	14	7.00
ROT-142-016 T	16	7.00
ROT-142-018 T	18	7.00
ROT-142-020 T	20	7.00
ROT-142-022 T	22	10.00
ROT-142-024 T	24	10.00
ROT-142-026 T	26	10.00
ROT-142-028 T	28	10.00
ROT-142-030 T	30	10.00
ROT-142-032 T	32	10.00
ROT-142-034 T	34	10.00
ROT-142-036 T	36	10.00

Interference screws, cannulated with head

Interferenzschrauben, durchbohrt mit Kopf

Indication: The core of the screw is large for optimum contact of the graft with the spongy part of the wall in bone tunnel - The diameter of the screw core is increased at its head to provide firm grip with cortical bone in tunnel. The screw is cannulated to provide passage for mandril preventing any deviation in spongy bone - The mandril also enables an easy exchange of the screw if case arises. Softly rounded thread edge - Large pitch thread to reduce excessive rubbing with fibers.

Material: The cannulated interference screws is manufactured from titanium Ti6Al4V according to ASTM F.136 - ISO 5832/3. which has been specifically designed for the manufacture of orthopaedic implants. This alloy characterized by demonstrating excellent biocompatibility together with a high resistance of corrosion and superiormechnical strength.



Ref. No Titanium	Diameter mm Durchmesser mm	Screw length mm Schraubenlänge mm
ROT-145020-07 T	7	20
ROT-145025-07 T	7	25
ROT-145030-07 T	7	30
ROT-145020-08 T	8	20
ROT-145025-08 T	8	25
ROT-145030-08 T	8	30
ROT-145020-09 T	9	20
ROT-145025-09 T	9	25
ROT-145030-09 T	9	30

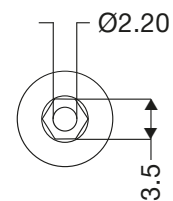



Interference screws, cannulated without head

Interferenzschrauben, durchbohrt ohne Kopf

Indication: The core of the screw is large for optimum contact of the graft with the spongy part of the wall in bone tunnel - The diameter of the screw core is increased at its head to provide firm grip with cortical bone in tunnel. The screw is cannulated to provide passage for mandril preventing any deviation in spongy bone - The mandril also enables an easy exchange of the screw if case arises. Softly rounded thread edge - Large pitch thread to reduce excessive rubbing with fibers.

Material: The cannulated interference screws is manufactured from titanium Ti6Al4V according to ASTM F.136 - ISO 5832/3. which has been specifically designed for the manufacture of orthopaedic implants. This alloy characterized by demonstrating excellent biocompatibility together with a high resistance of corrosion and superiormechanical strength.

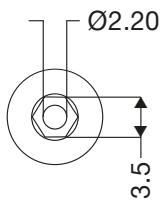





Ref. No Titanium	Diameter mm Durchmesser mm	Screw length mm Schraubenlänge mm
ROT-146020-07 T	7	20
ROT-146025-07 T	7	25
ROT-146030-07 T	7	30
ROT-146020-08 T	8	20
ROT-146025-08 T	8	25
ROT-146030-08 T	8	30
ROT-146020-09 T	9	20
ROT-146025-09 T	9	25
ROT-146030-09 T	9	30

Washers for screws

Unterlagscheibe für Schrauben

Material: Certified Stainless Steel according to ASTM F.138 - ISO 5832/1. Certified Titanium alloy according to ASTM F.136 - ISO 5832/3.

	Outside diameter Aussendurchmesser	Washer Thickness Scheibenstärke		
For screws / für Schrauben / pour Vis Ø 4.5 mm / Ø 6.5 mm / Ø 7.0 mm / Ø 7.3 mm				
Stainless Steel	13.00 mm	1.5 mm	ROT-199-130	 13 mm
Titanium	13.00 mm	1.5 mm	ROT-199-130 T	
For cannulated screws / für durchbohrte Schrauben Ø 4.5 mm / Ø 6.5 mm / Ø 7.0 mm / Ø 7.3 mm				
Stainless Steel	10.00 mm	1.0 mm	ROT-199-100	 10 mm
Titanium	10.00 mm	1.0 mm	ROT-199-100 T	
For screws / für Schrauben / pour Vis Ø 2.7 mm / Ø 3.5 mm / Ø 4.0 mm				
Stainless Steel	7.00 mm	0.8 mm	ROT-199-070	 7 mm
Titanium	7.00 mm	0.8 mm	ROT-199-070 T	
For screws / für Schrauben / pour Vis Ø 1.5 mm / Ø 2.0 mm				
Stainless Steel	4.50 mm	0.6 mm	ROT-199-045	 4.5 mm
Titanium	4.50 mm	0.6 mm	ROT-199-045 T	
Nut for cortical screws / Mutter für Kortikalisschrauben Ø 4.5 mm				
Stainless Steel	11.00 mm		ROT-198-110	 11 mm
Titanium	11.00 mm		ROT-198-110 T	



Broad Compression plates MC-DCP 4.5 mm

Breit Kompressionsplatten MC-DCP 4.5 mm

Plaque à compression large MC-DCP 4.5 mm

Indication: Used for pseudarthrosis of the humerus and as a tension band plate for femoral fractures. **Not for use on the tibia.** The MC-DCP holes allow compression in both directions of the longitudinal axis. MC-DCP: Minimal contact dynamic compression plate.

Plate thickness: 5.0 mm

Plate width: 17.5 mm

Hole spacing: 18.0 mm

Screws to be used: All holes accept diam. 4.5 mm cortical screws. The end hole can be used for diam. 6.5 mm cancellous screws. Undercuts for vascular preservation.

Plate details: Use broad plates with 6 or 7 holes in exceptional cases only on humerus.

Material: Certified Stainless Steel according to ASTM F.138 - ISO 5832/1. Certified Titanium alloy according to ASTM F.136 - ISO 5832-3

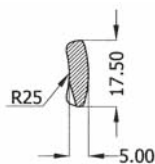
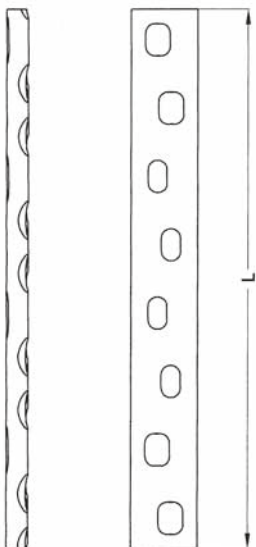

Ref. No Stainless Steel	Ref. No Titanium	Holes	Length mm
ROT-201106-06	ROT-201106-06 T	6	106
ROT-201124-07	ROT-201124-07 T	7	124
ROT-201142-08	ROT-201142-08 T	8	142
ROT-201160-09	ROT-201160-09 T	9	160
ROT-201178-10	ROT-201178-10 T	10	178
ROT-201196-11	ROT-201196-11 T	11	196
ROT-201214-12	ROT-201214-12 T	12	214
ROT-201232-13	ROT-201232-13 T	13	232
ROT-201250-14	ROT-201250-14 T	14	250
ROT-201268-15	ROT-201268-15 T	15	268
ROT-201286-16	ROT-201286-16 T	16	286
ROT-201304-17	ROT-201304-17 T	17	304
ROT-201322-18	ROT-201322-18 T	18	322

Narrow Plate MC-DCP 4.5 mm

Schmalplatte MC-DCP 4.5 mm

Plaque étroite MC-DCP 4.5 mm

Indication: Used as a neutralisation and tension band plate for fractures of forearm, humerus and tibia. **Not for use on the femur.** The MC-DCP holes allow compression in both directions of the longitudinal axis. MC-DCP: Minimal contact dynamic compression plate.

Plate details: Use broad plates with 6 or 7 holes in exceptional cases only on humerus.

Plate thickness: 4.6 mm

Plate width: 13.5 mm

Hole spacing: 18.0 mm

Screws to be used: All holes accept diam. 4.5 mm cortical screws. The end hole can be used for diam. 6.5 mm cancellous screws.

Material: Certified Stainless Steel according to ASTM F.138 - ISO 5832/1. Certified Titanium alloy according to ASTM F.136 - ISO 5832-3

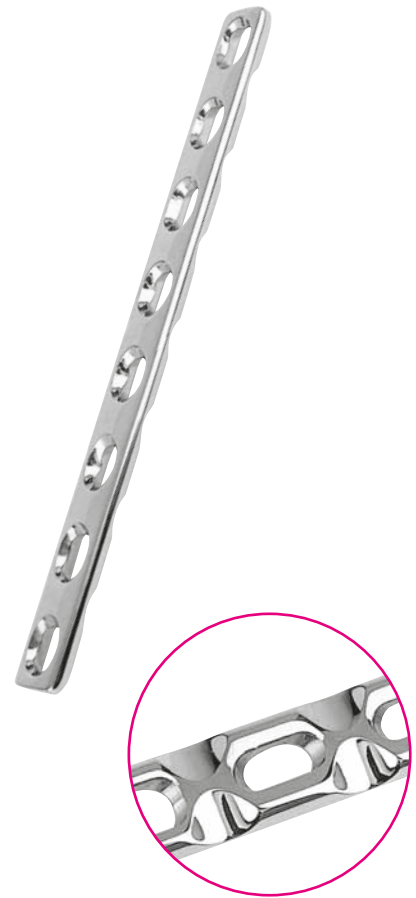

Ref. No Stainless Steel	Ref. No Titanium	Holes	Length mm
ROT-202034-02	ROT-202034-02 T	2	34
ROT-202052-03	ROT-202052-03 T	3	52
ROT-202070-04	ROT-202070-04 T	4	70
ROT-202088-05	ROT-202088-05 T	5	88
ROT-202106-06	ROT-202106-06 T	6	106
ROT-202124-07	ROT-202124-07 T	7	124
ROT-202142-08	ROT-202142-08 T	8	142
ROT-202160-09	ROT-202160-09 T	9	160
ROT-202178-10	ROT-202178-10 T	10	178
ROT-202196-11	ROT-202196-11 T	11	196
ROT-202214-12	ROT-202214-12 T	12	214
ROT-202232-13	ROT-202232-13 T	13	232
ROT-202250-14	ROT-202250-14 T	14	250
ROT-202268-15	ROT-202268-15 T	15	268
ROT-202286-16	ROT-202286-16 T	16	286

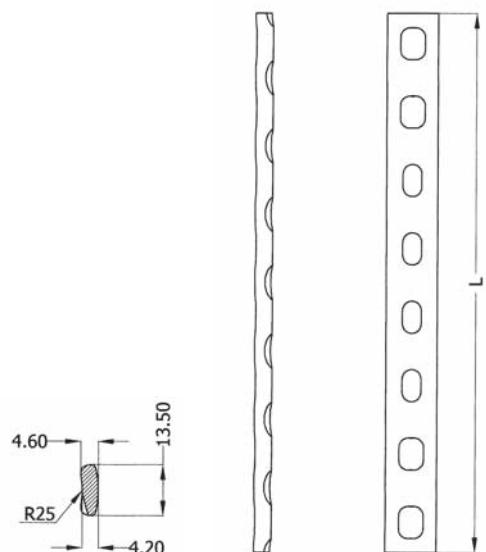



Narrow Plate MC-DCP 3.5 mm

Schmalplatte MC-DCP 3.5 mm

Plaque étroite MC-DCP 3.5 mm

Indication: Used for smaller bones particularly ulna and radius. The MC-DCP holes allow compression in both directions of the longitudinal axis.
MC-DCP: Minimal contact dynamic compression plate.

Plate details:
Plate profile 4.0 x 11.0 mm

Plate thickness: 4.0 mm

Plate width: 11.0 mm

Hole spacing: 13.0 mm

Screws to be used: Fixation with 3.5 mm small cortical screws and 4.0 mm small cancellous screws.

Material: Certified Stainless Steel according to ASTM F.138 - ISO 5832/1. Certified Titanium alloy according to ASTM F.136 - ISO 5832-3

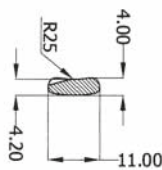
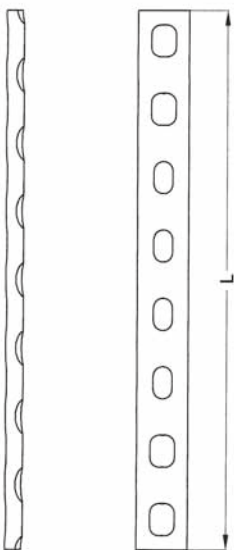

Ref. No Stainless Steel	Ref. No Titanium	Holes	Length mm
ROT-203051-04	ROT-203051-04 T	4	51
ROT-203064-05	ROT-203064-05 T	5	64
ROT-203077-06	ROT-203077-06 T	6	77
ROT-203090-07	ROT-203090-07 T	7	90
ROT-203103-08	ROT-203103-08 T	8	103
ROT-203116-09	ROT-203116-09 T	9	116
ROT-203129-10	ROT-203129-10 T	10	129
ROT-203142-11	ROT-203142-11 T	11	142
ROT-203155-12	ROT-203155-12 T	12	155

Broad lengthening Plate 4.5 mm with 8 and 10 holes

Großfragment 1/4-Rohr, breite Verlängerungsplatte 4.5 mm mit 8 und 10 Löcher

Plaque d'allogement large 4.5 mm à 8 et 10 trous

Indication: Used for the lengthening osteotomies of the femur. Slot for articulated tension device for distraction or compression.

Screws to be used: Fixation with diam. 4.5 mm cortical screws.

6.5 mm cancellous screw may also be used in the end holes. Slot for distraction or compression with articulated tension device.

Plate details: Plate profile 16.0 mm x 5.0 mm

Plate thickness: 5.0 mm

Plate width: 16.0 mm

Hole spacing: 15.5 mm for 8 Holes
14.5 mm for 10 Holes

Material: Certified Stainless Steel according to ASTM F.138 - ISO 5832/1.



Ref. No	Lengthening L1	Holes	Length L mm
ROT-204135-08	30	8	135
ROT-204145-08	40	8	145
ROT-204155-08	50	8	155
ROT-204165-08	60	8	165
ROT-204175-08	70	8	175
ROT-204170-10	40	10	170
ROT-204180-10	50	10	180
ROT-204190-10	60	10	190
ROT-204200-10	70	10	200
ROT-204210-10	80	10	210
ROT-204220-10	90	10	220
ROT-204230-10	100	10	230
ROT-204240-10	110	10	240
ROT-204250-10	120	10	250

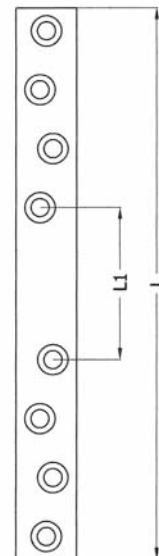
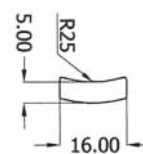



Narrow lengthening Plate 4.5 mm with 8 holes

Großfragment 1/4-Rohr, schmal Verlängerungsplatte 4.5 mm mit 8 Löcher

Plaque d'allogement étroite 4.5 mm à 8 trous

Indication: Used for the lengthening osteotomies of the tibia. Slot for articulated tension device for distraction or compression.

Screws to be used: Fixation with diam. 4.5 mm cortical screws. 6.5 mm cancellous screw may also be used in the end holes. Slot for distraction or compression with articulated tension device.

Plate details: Plate profile 12.0 mm x 4.0 mm

Plate thickness: 4.0 mm

Plate width: 12.0 mm

Hole spacing: 15.5 mm for 8 Holes
14.5 mm for 10 Holes

Material: Certified Stainless Steel according to ASTM F.138 - ISO 5832/1.

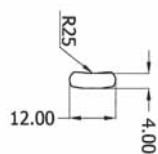

Ref. No	Lengthening L1	Holes	Length L mm
ROT-205135-08	30	8	135
ROT-205145-08	40	8	145
ROT-205155-08	50	8	155
ROT-205165-08	60	8	165
ROT-205175-08	70	8	175
ROT-205185-08	80	8	185

Broad Plate 4.5 mm

Großfragment 1/4-Rohr, breite Platten 4.5 mm

Plaque large 4.5 mm

Indication: Used for pseudarthrosis of humerus and as a tension band plate for femoral fractures. Not for use on the tibia. Compression is achieved by use tension device.

Plate details: Use plates with 6 or 7 holes in exceptional cases only on humerus.

Plate thickness: 5.0 mm

Plate width: 16.0 mm

Hole spacing: 16.0 mm

Screws to be used: All holes accept diam. 4.5 mm cortical screws.

The end hole can be used for diam. 6.5 mm cancellous screws.

Material: Certified Stainless Steel according to ASTM F.138 - ISO 5832/1.



Ref. No DCP Holes Stainless Steel	Ref. No DCP Holes Titan	Holes	Length mm
ROT-206087-05 D	ROT-206087-05 DT	5	87
ROT-206103-06 D	ROT-206103-06 DT	6	103
ROT-206119-07 D	ROT-206119-07 DT	7	119
ROT-206135-08 D	ROT-206135-08 DT	8	135
ROT-206151-09 D	ROT-206151-09 DT	9	151
ROT-206167-10 D	ROT-206167-10 DT	10	167
ROT-206183-11 D	ROT-206183-11 DT	11	183
ROT-206199-12 D	ROT-206199-12 DT	12	199
ROT-206215-13 D	ROT-206215-13 DT	13	215
ROT-206231-14 D	ROT-206231-14 DT	14	231
ROT-206247-15 D	ROT-206247-15 DT	15	247
ROT-206263-16 D	ROT-206263-16 DT	16	263
ROT-206279-17 D	ROT-206279-17 DT	17	279
ROT-206295-18 D	ROT-206295-18 DT	18	295
ROT-206327-20 D		20	327
ROT-206359-22 D		22	359
ROT-206391-24 D		24	391

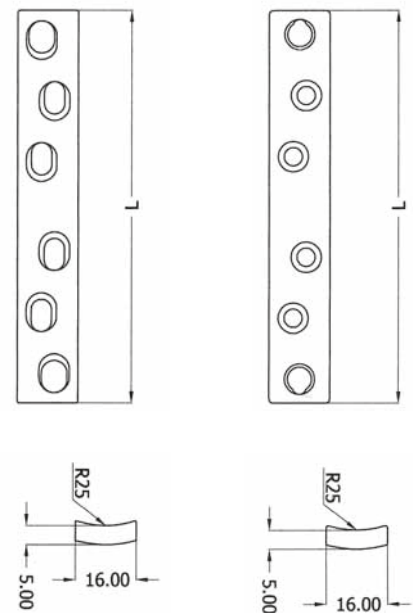



Narrow Plate 4.5 mm

Großfragment 1/4-Rohr, schmale Platten 4.5 mm

Plaque étroite 4.5 mm

Indication: Used as neutralization and tension band plates for fractures of forearm, humerus and tibia. Compression achieved through the use of the tension device.

Hole spacing: 16.0 mm

Screws to be used: All holes accept diam. 4.5 mm cortical screws. The end of holes are designed for cancellous bone screws. Plates are slotted to accept a tension device.

Plate details: Use plates with 2,3 or 4 holes in exceptional cases only.

Plate thickness: 4.0 mm

Plate width: 12.0 mm

Material: Certified Stainless Steel according to ASTM F.138 - ISO 5832/1.

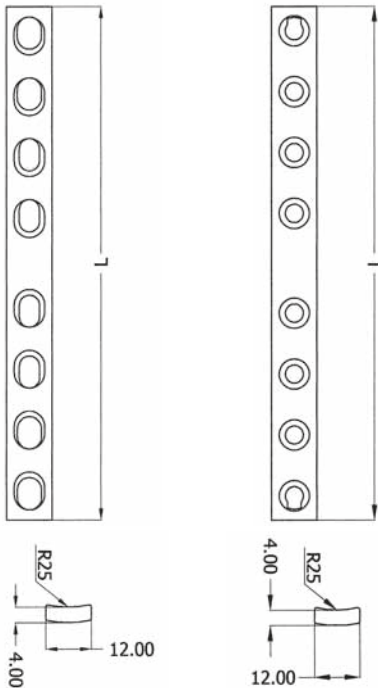

Ref. No DCP Holes Stainless Steel	Ref. No DCP Holes Titan	Holes	Length mm
ROT-207039-02 D	ROT-207039-02 DT	2	39
ROT-207055-03 D	ROT-207055-03 DT	3	55
ROT-207071-04 D	ROT-207071-04 DT	4	71
ROT-207087-05 D	ROT-207087-05 DT	5	87
ROT-207103-06 D	ROT-207103-06 DT	6	103
ROT-207119-07 D	ROT-207119-07 DT	7	119
ROT-207135-08 D	ROT-207135-08 DT	8	135
ROT-207151-09 D	ROT-207151-09 DT	9	151
ROT-207167-10 D	ROT-207167-10 DT	10	167
ROT-207183-11 D	ROT-207183-11 DT	11	183
ROT-207199-12 D	ROT-207199-12 DT	12	199
ROT-207215-13 D	ROT-207215-13 DT	13	215
ROT-207231-14 D	ROT-207231-14 DT	14	231
ROT-207247-15 D	ROT-207247-15 DT	15	247
ROT-207263-16 D	ROT-207263-16 DT	16	263
ROT-207295-18 D	ROT-207295-18 DT	18	295
ROT-207327-20 D		20	327
ROT-207359-22 D		22	359
ROT-207391-24 D		24	391

Narrow plate 3.5 mm

Schmale Platten 3.5 mm

Plaque étroite 3.5 mm

Indication: Used for smaller bones particularly ulna and radius. Compression achieved through individual hole design, in which engagement between the spherical undersurface of screw head and sloping base of the elongated screw hole, creates relatively movement between bone and plate in the direction of the fracture site, so compressing the fracture. Compression can also be achieved using the tension device.

Plate details:

Plate profile 11.0 x 2.50

Plate thickness: 2.5 mm

Plate width: 11.0 mm

Hole spacing: 16.0 mm

Screws to be used: All holes accept diam. 3.5 mm cortical screws and diam. 4.0 mm small cancellous screws.

Material: Certified Stainless Steel according to ASTM F.138 - ISO 5832/1.



Ref. No	Holes	Length mm
DCP Holes		
ROT-208039-02 D	2	39
ROT-208055-03 D	3	55
ROT-208071-04 D	4	71
ROT-208087-05 D	5	87
ROT-208103-06 D	6	103
ROT-208119-07 D	7	119
ROT-208135-08 D	8	135
ROT-208151-09 D	9	151
ROT-208167-10 D	10	167
ROT-208183-11 D	11	183
ROT-208199-12 D	12	199

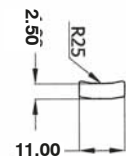
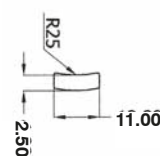
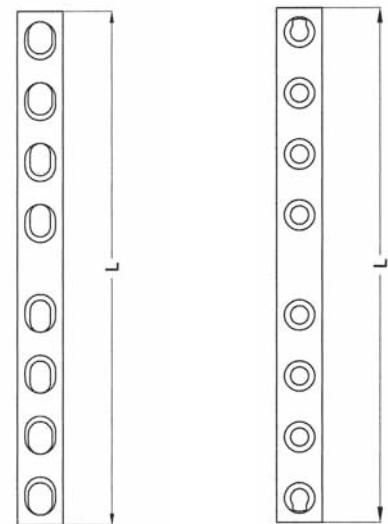



Small Fragment Plate 3.5 mm

Kleinfragmentplatte 3.5 mm

Mini - plaque à compression 3.5 mm

Indication: Used for the treatment of smaller bones, particularly radius and cubitus. Compression is achieved through individual hole design, in which engagement between the spherical undersurface of the screw head and sloping base of elongated screw hole, creates relative movement between bone and plate in the direction of the fracture site, so compression can also be achieved using the tension device.

Plate details:

Plate profile 3.4 x 10.0 mm

Plate thickness: 3.4 mm

Plate width: 10.0 mm

Hole spacing: 12.0 mm

Screws to be used: Fixation with diam. 3.5 mm small cortical screws.

Material: Certified Stainless Steel according to ASTM F.138 - ISO 5832/1.

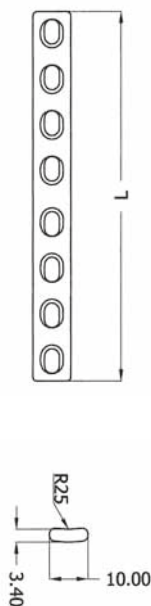

Ref. No DCP Holes Stainless Steel	Ref. No DCP Holes Titan	Holes	Length mm
ROT-209026-02 D	ROT-209026-02 DT	2	26
ROT-209038-03 D	ROT-209038-03 DT	3	38
ROT-209050-04 D	ROT-209050-04 DT	4	50
ROT-209062-05 D	ROT-209062-05 DT	5	62
ROT-209074-06 D	ROT-209074-06 DT	6	74
ROT-209086-07 D	ROT-209086-07 DT	7	86
ROT-209098-08 D	ROT-209098-08 DT	8	98
ROT-209110-09 D	ROT-209110-09 DT	9	110
ROT-209122-10 D	ROT-209122-10 DT	10	122
ROT-209134-11 D	ROT-209134-11 DT	11	134
ROT-209146-12 D	ROT-209146-12 DT	12	146
ROT-209158-13 D		13	158
ROT-209170-14 D		14	170
ROT-209182-15 D		15	182
ROT-209194-16 D		16	194
ROT-209218-18 D		18	218

Semi-Tubular Plate 4.5 mm

Halbrohrplatte 4.5 mm

Plaque demi-tube 4.5 mm

Indication: Primarily indicated for areas of low stress such as forearm-radius recommended for the fractures of fibula. Compression is applied by eccentric positioning of the screw against the side of the screw hole furthest from the fracture line

Plate thickness: 1.0 mm

Plate width: 11.7 mm

Hole spacing: 16.0 mm

Screws to be used: Fixation with diam. 4.5 mm cortical screws and diam. 6.5 mm cancellous screws.

Material: Certified Stainless Steel according to ASTM F.138 - ISO 5832/1.

Plate details:

Profile half of a 12.0 mm tube.



Ref. No DCP Holes Stainless Steel	Ref. No DCP Holes Titan	Holes	Length mm
ROT-210039-02 D	ROT-210039-02 DT	2	39
ROT-210055-03 D	ROT-210055-03 DT	3	55
ROT-210071-04 D	ROT-210071-04 DT	4	71
ROT-210087-05 D	ROT-210087-05 DT	5	87
ROT-210103-06 D	ROT-210103-06 DT	6	103
ROT-210119-07 D	ROT-210119-07 DT	7	119
ROT-210135-08 D	ROT-210135-08 DT	8	135
ROT-210151-09 D	ROT-210151-09 DT	9	151
ROT-210167-10 D	ROT-210167-10 DT	10	167
ROT-210183-11 D	ROT-210183-11 DT	11	183
ROT-210199-12 D	ROT-210199-12 DT	12	199

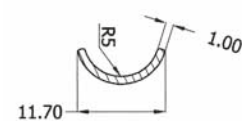



One-third Tubular Plate 3.5 mm

Drittelrohrplatte 3.5 mm

Plaque tiers de tube 3.5 mm

Indication: Used as buttress plate for fibula, metatarsals, and metacarpals bones. Compression is applied by eccentric positioning of the screw against the side of the fracture line.

Screws to be used: Fixation with diam. 3.5 mm small cortical screws and diam. 4.0 mm small cancellous screws. Compression effect can be achieved by eccentric insertion of distal screws from the fracture line.

Plate details:

Profile one-third of a 12.0 mm tube

Plate thickness: 1.0 mm

Plate width: 9.0 mm

Hole spacing: 12.0 mm

Material: Certified Stainless Steel according to ASTM F.138 - ISO 5832/1. Certified Titanium alloy according to ASTM F.136 - ISO 5832/3.

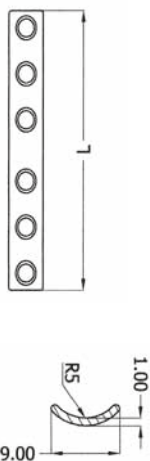

Ref. No Stainless Steel	Ref. No Titanium	Holes	Length mm
ROT-211025-02 D	ROT-211025-02 DT	2	25
ROT-211037-03 D	ROT-211037-03 DT	3	37
ROT-211049-04 D	ROT-211049-04 DT	4	49
ROT-211061-05 D	ROT-211061-05 DT	5	61
ROT-211073-06 D	ROT-211073-06 DT	6	73
ROT-211085-07 D	ROT-211085-07 DT	7	85
ROT-211097-08 D	ROT-211097-08 DT	8	97
ROT-211109-09 D	ROT-211109-09 DT	9	109
ROT-211121-10 D	ROT-211121-10 DT	10	121
ROT-211133-11 D	ROT-211133-11 DT	11	133
ROT-211145-12 D	ROT-211145-12 DT	12	145
ROT-211157-13 D		13	157
ROT-211169-14 D		14	169
ROT-211181-15 D		15	181
ROT-211193-16 D		16	193
ROT-211217-18 D		18	217

Mini Fragment plate 2.7 mm

Minifragmentplatte 2.7 mm

Mini - plaque à compression 2.7 mm

Indication: Used for maxillofacial surgery, hand and foot surgery. Compression is achieved through individual hole design, in which engagement between the spherical undersurface of the screw head and sloping base of elongated screw hole, creates relative movement between bone and plate in the direction of the fracture site, so compression can also be achieved using the tension device.

Plate details:

Plate profile 2.5 x 8.0 mm

Plate thickness: 2.5 mm

Plate width: 8.0 mm

Hole spacing: 8.0 mm

Screws to be used: Fixation with diam. 2.7 mm mini cortical screws.

Material: Certified Stainless Steel according to ASTM F.138 - ISO 5832/1.



Ref. No DCP Holes Stainless Steel	Ref. No DCP Holes Titan	Holes	Length mm
ROT-212020-02 D	ROT-212020-02 DT	2	20
ROT-212028-03 D	ROT-212028-03 DT	3	28
ROT-212036-04 D	ROT-212036-04 DT	4	36
ROT-212044-05 D	ROT-212044-05 DT	5	44
ROT-212052-06 D	ROT-212052-06 DT	6	52
ROT-212060-07 D	ROT-212060-07 DT	7	60
ROT-212068-08 D	ROT-212068-08 DT	8	68
ROT-212076-09 D	ROT-212076-09 DT	9	76
ROT-212084-10 D	ROT-212084-10 DT	10	84
ROT-212092-11 D	ROT-212092-11 DT	11	92
ROT-212100-12 D	ROT-212100-12 DT	12	100

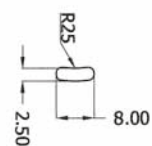



Sherman Plate 4.5 mm

Sherman Platte 4.5 mm

Plaque de Sherman 4.5 mm

Indication: Used principally in the reconstruction of the pelvis. The design of these plates allows for three dimensional contouring. Due to their reduced stiffness, they should only be used for tension-band fixation or adaption.

Plate thickness: 2.5 mm

Plate width: 11.0 mm

Hole spacing: 13.0 mm

Screws to be used: Fixation with diam. 4.5 mm cortical screws and diam. 6.5 mm cancellous screws.

Plate details: Reconstruction plates 4.5 mm are manufactured from relatively soft material. Design and softness of the material enable three-dimensional contouring. Do not bend more than 15° between holes.

Material: Certified Stainless Steel according to ASTM F.138 - ISO 5832/1.

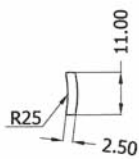
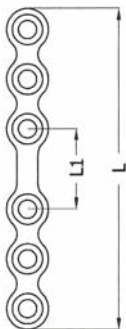

Ref. No Stainless Steel	Holes	Lengthening L1 (mm)	Length L (mm)
ROT-213058-04	4	21	58
ROT-213071-05	5	21	71
ROT-213084-06	6	21	84
ROT-213097-07	7	21	97
ROT-213110-08	8	21	110
ROT-213123-09	9	21	123
ROT-213136-10	10	21	136
ROT-213149-11	11	21	149
ROT-213162-12	12	21	162

Reconstruction Plate 4.5 mm

Rekonstruktionsplatte 4.5 mm

Plaque de reconstruction 4.5 mm

Indication: Used principally in the reconstruction of the pelvis. The design of these plates allows for three dimensional contouring. Due to their reduced stiffness, they should only be used for tension-band fixation or adaption.

Plate details: Reconstruction plates 4.5 mm are manufactured from relatively soft material. Design and softness of the material enable three-dimensional contouring. Do not bend more than 15° between holes.

Plate thickness: 2.7 mm

Plate width: 12.0 mm

Hole spacing: 16.0 mm

Screws to be used: Fixation with diam. 4.5 mm cortical screws and diam. 6.5 mm cancellous screws.

Material: Certified Stainless Steel according to ASTM F.138 - ISO 5832/1. Certified Titanium alloy according to ASTM F.136 - ISO 5832/3.



Ref. No Stainless Steel	Ref. No Titanium	Holes	Length mm
ROT-214045-03	ROT-214045-03 T	3	45
ROT-214061-04	ROT-214061-04 T	4	61
ROT-214077-05	ROT-214077-05 T	5	77
ROT-214093-06	ROT-214093-06 T	6	93
ROT-214109-07	ROT-214109-07 T	7	109
ROT-214125-08	ROT-214125-08 T	8	125
ROT-214141-09	ROT-214141-09 T	9	141
ROT-214157-10	ROT-214157-10 T	10	157
ROT-214173-11	ROT-214173-11 T	11	173
ROT-214189-12	ROT-214189-12 T	12	189
ROT-214205-13	ROT-214205-13 T	13	205
ROT-214221-14	ROT-214221-14 T	14	221
ROT-214237-15	ROT-214237-15 T	15	237
ROT-214253-16	ROT-214253-16 T	16	253

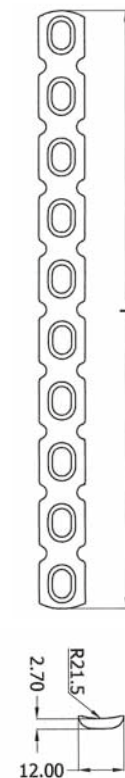



Reconstruction Plate 3.5 mm curved

Rekonstruktionplatte 3.5 mm gebogen

Plaque de reconstruction 3.5 mm pour le bassin

Indication: Used principally in the reconstruction of the pelvis. It is slightly thicker than the straight pelvic reconstruction plate and prevent for the pelvic crest.

Plate width: 12.0 mm

Hole spacing: 12.0 mm

Screws to be used: Fixation with diam. 3.5 mm and 4.0 mm small cancellous screws.

Plate details: This plate has been especially designed for use on the pelvis. Material is thicker than straight reconstruction plate.

Plate thickness: 2.7 mm

Material: Certified Stainless Steel according to ASTM F.138 - ISO 5832/1. Certified Titanium alloy according to ASTM F.136 - ISO 5832/3.



Ref. No Stainless Steel	Ref. No Titanium	Holes	Length mm
ROT-215070-06	ROT-215070-06 T	6	70
ROT-215094-08	ROT-215094-08 T	8	94
ROT-215118-10	ROT-215118-10 T	10	118
ROT-215142-12	ROT-215142-12 T	12	142
ROT-215166-14	ROT-215166-14 T	14	166
ROT-215190-16	ROT-215190-16 T	16	190
ROT-215214-18	ROT-215214-18 T	18	214

Reconstruction Plate 3.5 mm

Rekonstruktionsplatte 3.5 mm

Plaque de reconstruction 3.5 mm

Indication: Used principally in the treatment of pelvic, clavicle and calcaneal fractures. The design of these plates allows for three-dimensional contouring. Due to their reduced stiffness, they should be used only for cerclage or adaptations.

Plate details: Reconstruction plates 3.5 mm are manufactured from relatively soft material. Design and softness of the material enable three-dimensional contouring. Do not bend more than 15° between holes.

Plate thickness: 2.7 mm

Plate width: 10.0 mm

Hole spacing: 12.0 mm

Screws to be used: Fixation with diam. 3.5 mm cortical screws and diam. 4.0 mm small cancellous screws.

Material: Certified Stainless Steel according to ASTM F.138 - ISO 5832/1. Certified Titanium alloy according to ASTM F.136 - ISO 5832/3.



Ref. No Stainless Steel	Ref. No Titanium	Holes	Length mm
ROT-216034-03	ROT-216034-03 T	3	34
ROT-216046-04	ROT-216046-04 T	4	46
ROT-216058-05	ROT-216058-05 T	5	58
ROT-216070-06	ROT-216070-06 T	6	70
ROT-216082-07	ROT-216082-07 T	7	82
ROT-216094-08	ROT-216094-08 T	8	94
ROT-216106-09	ROT-216106-09 T	9	106
ROT-216118-10	ROT-216118-10 T	10	118
ROT-216130-11	ROT-216130-11 T	11	130
ROT-216142-12	ROT-216142-12 T	12	142
ROT-216154-13	ROT-216154-13 T	13	154
ROT-216166-14	ROT-216166-14 T	14	166
ROT-216178-15	ROT-216178-15 T	15	178
ROT-216190-16	ROT-216190-16 T	16	190
ROT-216214-18	ROT-216214-18 T	18	214

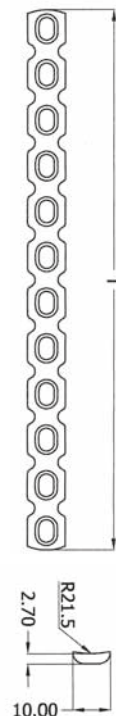



Reconstruction Plate 3.5 mm curved

Rekonstruktionplatte 3.5 mm gebogen

Plaque de reconstruction 3.5 mm pour le bassin

Indication: Used principally in the reconstruction of the pelvis. It is slightly thicker than the straight pelvic reconstruction plate and prevent for the pelvic crest.

Plate width: 10.0 mm

Hole spacing: 12.0 mm

Screws to be used: Fixation with diam. 3.5 mm small cortical screws.

Plate details: This plate has been especially designed for use on the pelvis. Material is thicker than straight reconstruction plate.

Material: Certified Stainless Steel according to ASTM F.138 - ISO 5832/1. Certified Titanium alloy according to ASTM F.136 - ISO 5832/3.

Plate thickness: 2.7 mm



Ref. No Stainless Steel	Ref. No Titanium	Holes	Length mm
ROT-217070-06	ROT-217070-06 T	6	70
ROT-217094-08	ROT-217094-08 T	8	94
ROT-217118-10	ROT-217118-10 T	10	118
ROT-217142-12	ROT-217142-12 T	12	142
ROT-217166-14	ROT-217166-14 T	14	166
ROT-217190-16	ROT-217190-16 T	16	190
ROT-217214-18	ROT-217214-18 T	18	214

Reconstruction Plate 2.7 mm

Rekonstruktionsplatte 2.7 mm

Plaque de reconstruction 2.7 mm

Indication: Indicate primarily in comminuted fractures of smaller diameter bones specially used for mandibular reconstruction surgery. The design of these plates allows for three dimensional contouring.

Plate thickness: 2.7 mm

Plate width: 8.0 mm

Hole spacing: 8.0 mm

Screws to be used: Fixation with diam. 2.7 mm mini cortical screws.

Material: Certified Stainless Steel according to ASTM F.138 - ISO 5832/1. Certified Titanium alloy according to ASTM F.136 - ISO 5832/3.

Plate details: Reconstruction plates 2.7 mm are manufactured from relatively soft material. Design and softness of the material enable three-dimensional contouring.



Ref. No Stainless Steel	Ref. No Titanium	Holes	Length mm
ROT-218032-04	ROT-218032-04 T	4	32
ROT-218040-05	ROT-218040-05 T	5	40
ROT-218048-06	ROT-218048-06 T	6	48
ROT-218056-07	ROT-218056-07 T	7	56
ROT-218064-08	ROT-218064-08 T	8	64
ROT-218072-09	ROT-218072-09 T	9	72
ROT-218080-10	ROT-218080-10 T	10	80
ROT-218088-11	ROT-218088-11 T	11	88
ROT-218096-12	ROT-218096-12 T	12	96
ROT-218104-13	ROT-218104-13 T	13	104
ROT-218112-14	ROT-218112-14 T	14	112
ROT-218120-15	ROT-218120-15 T	15	120
ROT-218128-16	ROT-218128-16 T	16	128
ROT-218136-17	ROT-218136-17 T	17	136
ROT-218144-18	ROT-218144-18 T	18	144
ROT-218152-19	ROT-218152-19 T	19	152
ROT-218160-20	ROT-218160-20 T	20	160
ROT-218176-22	ROT-218176-22 T	22	176
ROT-218192-24	ROT-218192-24 T	24	192

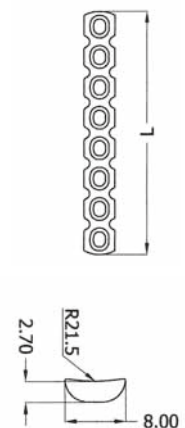



Y - Reconstruction Plate 3.5 mm

Y - Rekonstruktionsplatte 3.5 mm

Plaque de reconstruction en Y 3.5 mm

Indication: Used to treat comminuted fractures, particularly of the distal humerus. The design of these plates allows for three-dimensional contouring.

Plate details: Y reconstruction plates are manufactured from relatively soft material. Design and softness of the material enable three-dimensional contouring. If necessary, the plate can be shortened by breaking or cutting. Adjustable in three-dimension with bending pliers.

Plate thickness: 1.5 mm

Plate width: 9.0 mm

Hole spacing: 12.0 mm

Screws to be used: Fixation with diam. 3.5 mm small cortical screws and 4.0 mm small cancellous screws.

Material: Certified Stainless Steel according to ASTM F.138 - ISO 5832/1. Certified Titanium alloy according to ASTM F.136 - ISO 5832/3.

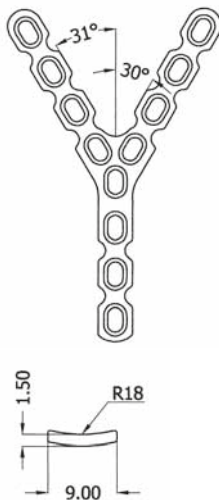

Ref. No Stainless Steel	Ref. No Titanium	Holes Shaft	Total Holes
ROT-219060-04	ROT-219060-04 T	4	4x4x4

Y - Fork Plate 4.5 mm

Y - Gabelplatte 4.5 mm

Plaque de fourchette en Y 4.5 mm

Indication: Used to treat comminuted distal humerus intra-articular or extra-articular fractures. Depending on the fracture configuration like T or Y type, the plates are shaped to be placed according to the anatomy of proximal humerus. The pre-formed shape of the plate requires that a separate plate to be used for right and left humerus.

Plate thickness: 2.5 mm

Plate width: 16.0 mm

Hole spacing: 16.0 mm

Screws to be used: Head of plate accepts diam. 6.5 mm cancellous screws. Plate shaft accepts diam. 4.5 mm cortical screws.

Material: Certified Stainless Steel according to ASTM F.138 - ISO 5832/1.

Plate details: Plate profile with radius 2.5 mm x 16.0mm

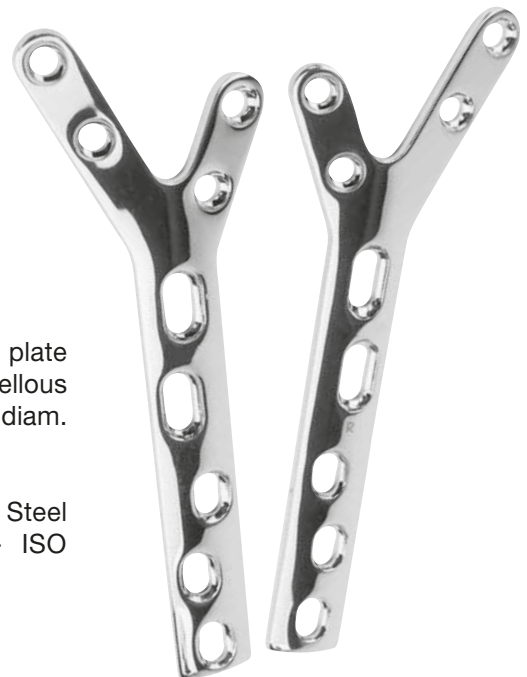

Ref. No	Style	Holes	Length L mm	Length L1 mm
ROT-220088-03 R	Right	3	88	101
ROT-220120-05 R	Right	5	120	133
ROT-220168-08 R	Right	8	168	181
ROT-220088-03 L	Left	3	88	101
ROT-220120-05 L	Left	5	120	133
ROT-220168-08 L	Left	8	168	181

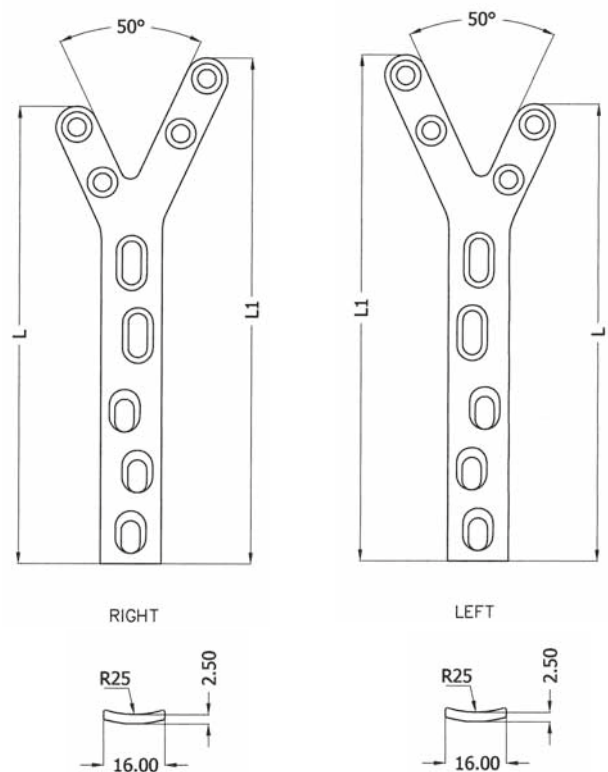



Y - Distal Humerus Plate 4.5 mm

Y - Distale Humerusplatte 4.5 mm

Plaque pour humerus distal en Y 4.5 mm

Indication: Used to treat comminuted distal humerus intra-articular or extra-articular fractures. Depending on the fracture configuration like T or Y type, the plates are shaped to be placed according to the anatomy of proximal humerus. The pre-formed shape of the plate requires that a separate plate to be used for right and left humerus. It should be bend preoperatively to accurately match the counters of the segment of the bone to be fixed. And oval hole allows for temporary fixation of the plate prior to final adjustment and fixation.

Plate details: Plate profile with radius 2.3 mm x 14.0mm

Plate thickness: 2.3 mm

Plate width: 14.0 mm

Hole spacing: 17.0 mm

Screws to be used: Head of plate accepts diam. 6.5 mm cancellous screws. Plate shaft accepts diam. 4.5 mm cortical screws.

Material: Certified Stainless Steel according to ASTM F.138 - ISO 5832/1.

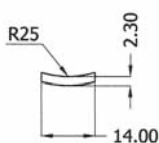
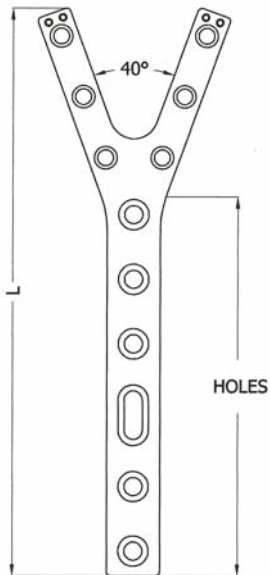

Ref. No	Style	Holes	Length mm
Stainless Steel			
ROT-221137-05 R	Right	5	137
ROT-221150-06 R	Right	6	150
ROT-221167-07 R	Right	7	167
ROT-221201-09 R	Right	9	201
ROT-221137-05 L	Left	5	137
ROT-221150-06 L	Left	6	150
ROT-221167-07 L	Left	7	167
ROT-221201-09 L	Left	9	201

Epicondylar Plate 3.5 mm

Epi-Kondylenplatte 3.5 mm

Plaque type lecestre 3.5 mm

Indication: The epicondylar humerus plates have been designed to be used for the distal fractures of humerus. Particularly can be indicate for multi-fragmented fracture of distal humerus joint, according to the anatomy of medial and lateral epicondyle. The pre-formed shape of the plate requires that a separate plate to be used for right and left distal humerus.

Plate details: Plate profile with radius 0.8 mm x 11.5mm

Plate thickness: 0.8 mm

Plate width: 11.5 mm

Hole spacing: 14.0 mm

Screws to be used: Fixation with diam. 3.5 mm small cortical screws and 4.0 mm small cancellous screws.

Material: Certified Stainless Steel according to ASTM F.138 - ISO 5832/1.



Ref. No	Style	Holes	Length mm
ROT-222092-05 R	Right	5	92
ROT-222120-07 R	Right	7	120
ROT-222142-09 R	Right	9	148
ROT-222176-11 R	Right	11	176
ROT-222204-13 R	Right	13	204
ROT-222092-05 L	Left	5	92
ROT-222120-07 L	Left	7	120
ROT-222142-09 L	Left	9	148
ROT-222176-11 L	Left	11	176
ROT-222204-13 L	Left	13	204

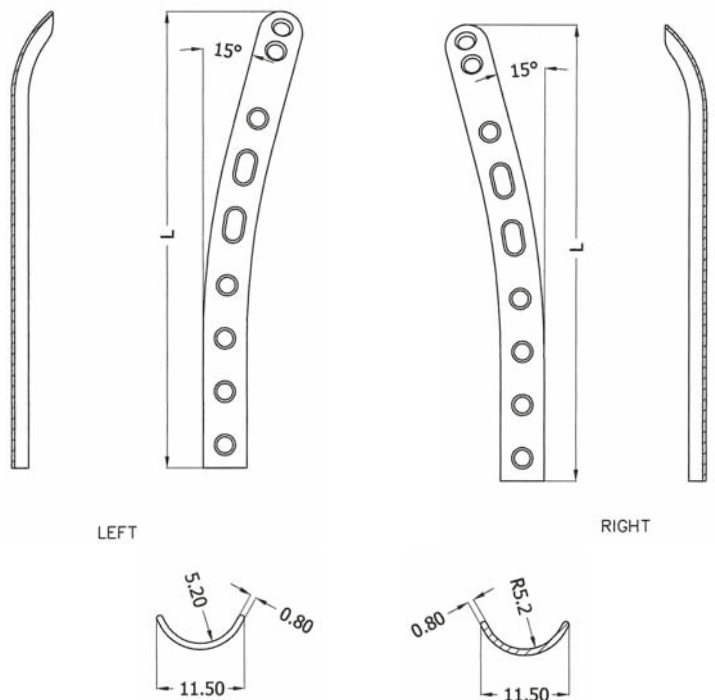

T - Humerus Plate 3.5 mm

T - Humerus Platte 3.5 mm

Plaque pour humerus en T 3.5 mm



Indication: The humerus T plates have been designed to be used for proximal humerus fractures. Design for both left and right side. The various configuration of T plate allow for anatomic reduction and alternative screw placement.

Plate details: Plate profile 2.5 x 16.0 mm. Anatomical shaping pre-contoured for left and right variations. Also eliminates manual contouring, simplifying and reducing operative time and reduces the incidence of bending stress patterns and subsequent weaknesses in plate. Plate head with radius.

Plate thickness: 2.5 mm

Plate width: 16.0 mm

Head width: 45.0 mm

Hole spacing: 16.0 mm

Screws to be used: Head of plate accept 4.0 mm cancellous screws. Plate shaft accepts 3.5 mm small cortical screws.

Material: Certified Stainless Steel according to ASTM F.138 - ISO 5832/1.

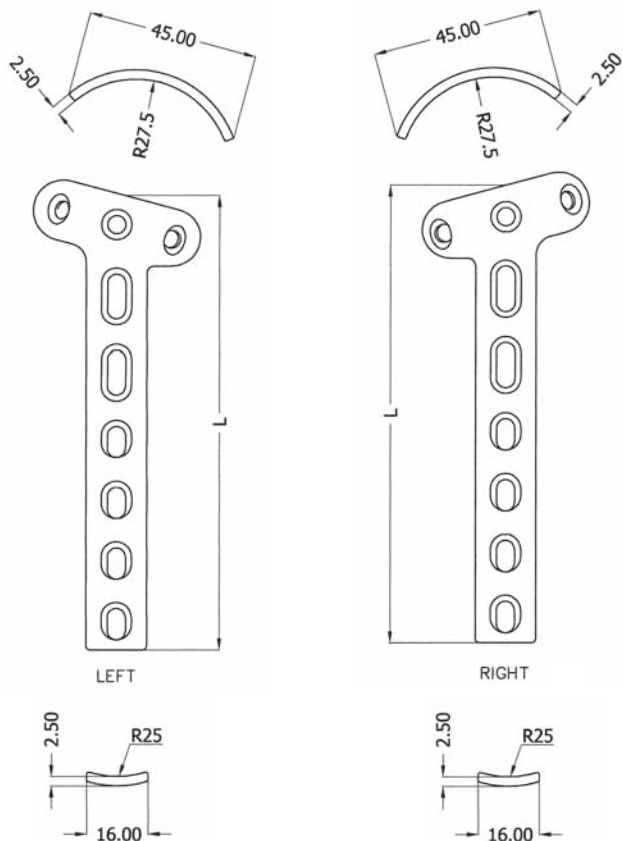

Ref. No	Style	Holes	Length mm
ROT-223068-03 R	Right	3	68.50
ROT-223084-04 R	Right	4	84.50
ROT-223100-05 R	Right	5	100.50
ROT-223116-06 R	Right	6	116.50
ROT-223132-07 R	Right	7	132.50
ROT-223148-08 R	Right	8	148.50
ROT-223068-03 L	Left	3	68.50
ROT-223084-04 L	Left	4	84.50
ROT-223100-05 L	Left	5	100.50
ROT-223116-06 L	Left	6	116.50
ROT-223132-07 L	Left	7	132.50
ROT-223148-08 L	Left	8	148.50

Proximal Humerus Plate 4.5 mm

Proximale Humerus Platte 4.5 mm

Plaque pour proximal humerus 4.5 mm

Indication: The proximal humerus plates have been designed to be used for proximal humerus fractures. Particularly the shape of this plate permit a stable fixation of two part surgical neck fracture. Head of plate with left and right variation allow anatomic reduction and alternative screw placement.

Plate thickness: 3.0 mm
Plate width: 17.0 mm
Head width: 24.5 mm
Hole spacing: 18.0 mm
Screws to be used: Head of plate accept 6.5 mm cancellous screws. Plate shaft accepts 4.5 mm cortical screws.

Material: Certified Stainless Steel according to ASTM F.138 - ISO 5832/1.

Plate details: Plate profile 3.0 mm x 17.0 mm. Anatomical shaping pre-contoured for left and right variations. Also eliminates manual contouring, simplifying and reducing operative time and reduces the incidence of bending stress patterns and subsequent weaknesses in plate.



Ref. No	Style	Holes	Length mm
Stainless Steel			
ROT-224080-05 R	Right	5	80
ROT-224098-06 R	Right	6	98
ROT-224116-07 R	Right	7	116
ROT-224080-05 L	Left	5	80
ROT-224098-06 L	Left	6	98
ROT-224116-07 L	Left	7	116

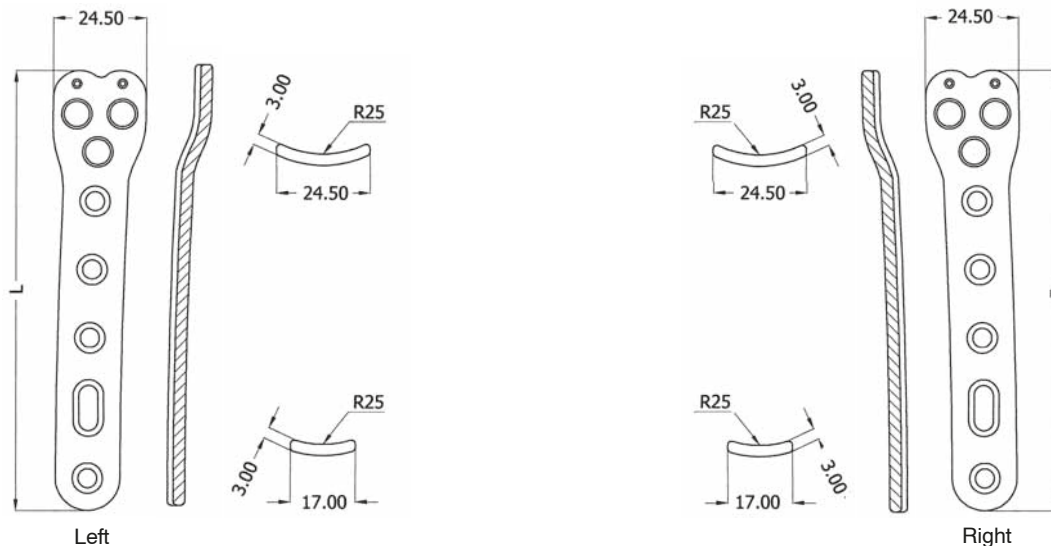

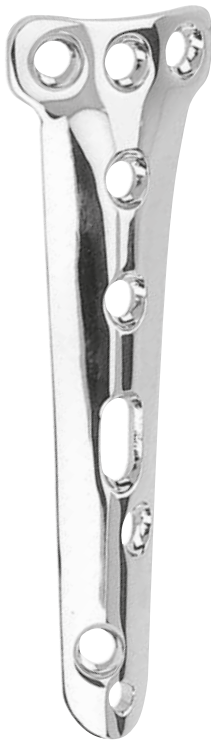

Spoon Plate 4.5 mm

Löffelplatte 4.5 mm

Plaque-cuillère 4.5 mm

Indication: The spoon plate is a buttress plate designed to sit on the anterior crest of the tibia. It is primarily indicated for pilon fractures that have extensive anterior crushing but good posture support. It is also used in the treatment of metaphyseal non-unions of distal tibia and the distal humerus. It should be bent pre-operative to accurately match the contours of the segment of bone to be fixed. An oval hole allows for temporary fixation of the plate prior to final adjustment and fixation.

fine adjustment to be made in theatre. Shaft with V-profile for the fixation on frontal edge of tibia.

Plate thickness: 2.5 mm

Plate width: 15.3 mm

Head width: 33.0 mm

Profile high: 6.0 mm

Screws to be used: Head of plate accept 6.5 mm cancellous screws. Plate shaft accepts 4.5 mm cortical screws.

Material: Certified Stainless Steel according to ASTM F.138 - ISO 5832/1. Certified Titanium alloy according to ASTM F.136 - ISO 5832/3.

Plate details: Plate is contoured during manufacture to approximate the eventual fracture site, allowing

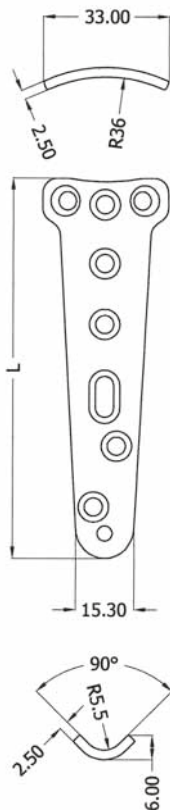

Ref. No Stainless Steel	Ref. No Titanium	Holes	Length
ROT-225100-05	ROT-225100-05 T	5	100
ROT-225120-06	ROT-225120-06 T	6	120

T - Plate 4.5 mm

T - Platte 4.5 mm

Plaque en T 4.5 mm

Indication: The T plate is primarily used as a buttress plate for medial tibial plateau. It is also used in the distal tibia, medial distal femur and A3 fractures of proximal humerus. It is relatively thin and consequently not as strong as standard self compressing plate. It is designed to be used as a buttress plate in areas of thin metaphyseal cortical bone or to prevent the collapsing of any cancellous defects in that area. It should be bent pre-operative to accurately match the contours of the segment of bone to be fixed. An oval hole allows for temporary fixation of the plate prior to final adjustment and fixation.

Plate details: Plate is contoured during manufacture to approximate the eventual fracture site, allowing fine adjustment to be made in theatre.

Plate thickness: 2.5 mm

Plate width: 16.0 mm

Head width: 34.0 mm

Hole spacing: 16.0 mm

Screws to be used: Head of plate accept 6.5 mm cancellous screws. Plate shaft accepts 4.5 mm cortical screws.

Material: Certified Stainless Steel according to ASTM F.138 - ISO 5832/1. Certified Titanium alloy according to ASTM F.136 - ISO 5832/3.



Ref. No Stainless Steel	Ref. No Titanium	Holes	Length mm
ROT-226068-03	ROT-226068-03 T	3	68
ROT-226084-04	ROT-226084-04 T	4	84
ROT-226100-05	ROT-226100-05 T	5	100
ROT-226116-06	ROT-226116-06 T	6	116
ROT-226132-07	ROT-226132-07 T	7	132
ROT-226148-08	ROT-226148-08 T	8	148
ROT-226164-09	ROT-226164-09 T	9	164
ROT-226180-10	ROT-226180-10 T	10	180
ROT-226196-11	ROT-226196-11 T	11	196
ROT-226212-12	ROT-226212-12 T	12	212

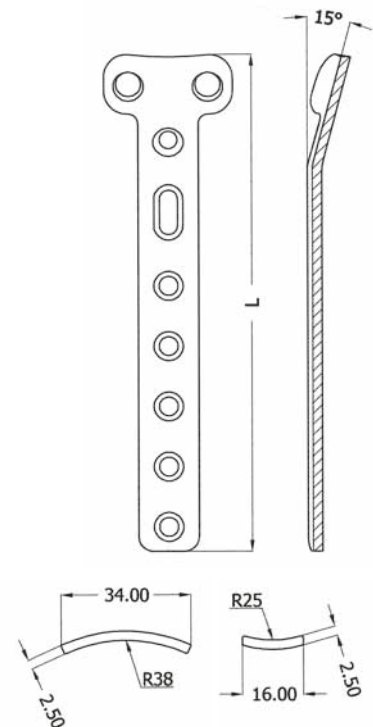

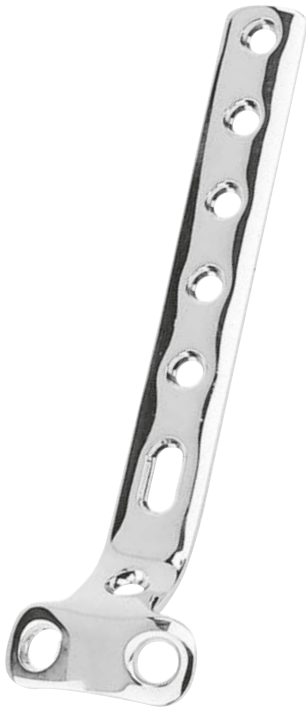

T-Buttress Plate 4.5 mm

T-Abstützplatte 4.5 mm

Plaque de soutien en T 4.5 mm

Indication: The T plate is primarily used as a buttress plate for medial tibial plateau. It is also used in the distal tibia, medial distal femur and A3 fractures of proximal humerus. It is relatively thin and consequently not as strong as standard self compressing plate. It is designed to be used as a buttress plate in areas of thin metaphyseal cortical bone or to prevent the collapsing of any cancellous defects in that area. It should be bent pre-operative to accurately match the counters of the segment of bone to be fixed. An oval hole allows for temporary fixation of the plate prior to final adjustment and fixation.

Plate details: Plate is contoured during manufacture to approximate the eventual fracture site, allowing fine adjustment to be made in theatre.

Plate thickness: 2.5 mm

Plate width: 16.0 mm

Head width: 34.0 mm

Hole spacing: 16.0 mm

Screws to be used: Head of plate accept 6.5 mm cancellous screws. Plate shaft accepts 4.5 mm cortical screws.

Material: Certified Stainless Steel according to ASTM F.138 - ISO 5832/1. Certified Titanium alloy according to ASTM F.136 - ISO 5832/3.

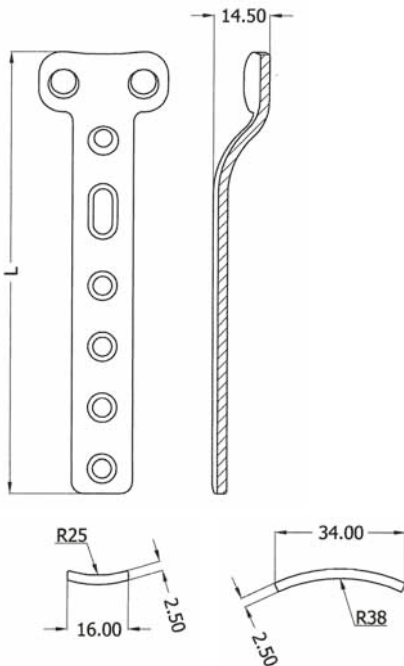

Ref. No Stainless Steel	Ref. No Titanium	Holes	Length mm
ROT-227082-04	ROT-227082-04 T	4	82
ROT-227098-05	ROT-227098-05 T	5	98
ROT-227114-06	ROT-227114-06 T	6	114
ROT-227130-07	ROT-227130-07 T	7	130
ROT-227146-08	ROT-227146-08 T	8	146
ROT-227162-09	ROT-227162-09 T	9	162
ROT-227178-10	ROT-227178-10 T	10	178

L - Plate 4.5 mm

L - Platte 4.5 mm

Plaque en L 4.5 mm

Indication: The L plate is an adaptation of a standard T plate. All holes configurations and plate dimensions are similar to that of the standard T plate, but the head of the plate is shifted either left or right to allow for alternative screw placement. Recommended for treatment of tibial head fractures.

Plate thickness: 2.0 mm
Plate width: 16.0 mm
Head width: 26.0 mm
Hole spacing: 16.0 mm
Screws to be used: Head of plate accept 6.5 mm cancellous screws. Plate shaft accepts 4.5 mm cortical screws.

Material: Certified Stainless Steel according to ASTM F.138 - ISO 5832/1.

Plate details: Plate is contoured during manufacture to approximate the eventual fracture site, allowing fine adjustment to be made in theatre.



Ref. No	Style	Holes	Length mm
Stainless Steel			
ROT-228087-04 R	Right	4	87
ROT-228119-06 R	Right	6	119
ROT-228151-08 R	Right	8	151
ROT-228167-10 R	Right	10	167
ROT-228087-04 L	Left	4	87
ROT-228119-06 L	Left	6	119
ROT-228151-08 L	Left	8	151
ROT-228167-10 L	Left	10	167

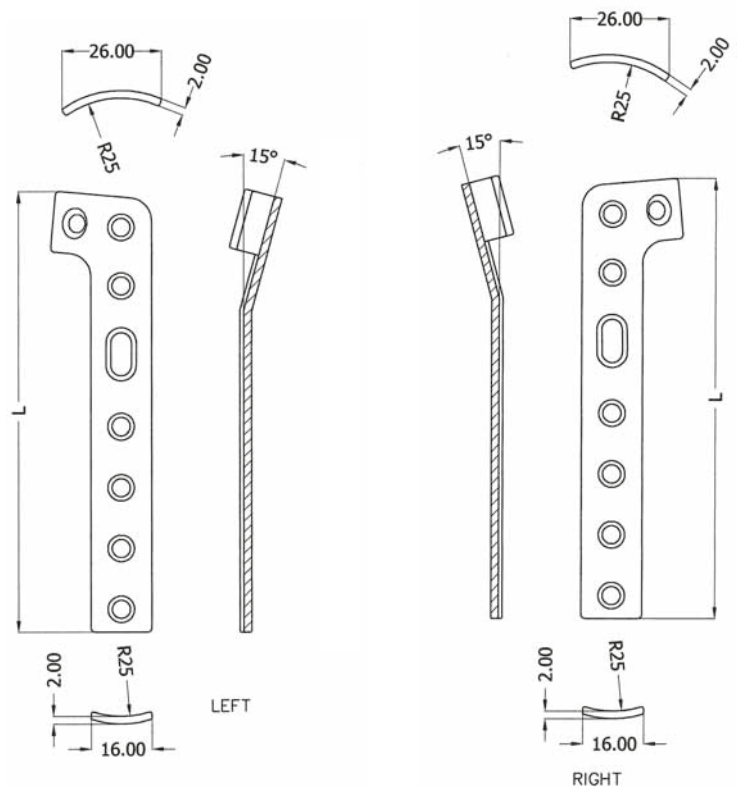

L-Buttress Plate 4.5 mm

L-Abstützplatte 4.5 mm

Plaque de soutien en L 4.5 mm



Indication: The L buttress plate is an adaptation of a standard T buttress plate. All holes configurations and plate dimensions are similar to that of the standard T buttress plate, but the head of the plate is shifted either left or right to allow for alternative screw placement. The double bend profile allows fixation on the lateral side of the tibia plateau. Recommended for treatment of tibial head fractures.

Plate details: Plate is contoured during manufacture to approximate the eventual fracture site, allowing fine adjustment to be made in theatre.

Plate thickness: 2.5 mm

Plate width: 15.5 mm

Head width: 33.2 mm

Hole spacing: 16.0 mm

Screws to be used: Head of plate accept 6.5 mm cancellous screws. Plate shaft accepts 4.5 mm cortical screws.

Material: Certified Stainless Steel according to ASTM F.138 - ISO 5832/1. Certified Titanium alloy according to ASTM F.136 - ISO 5832/3.

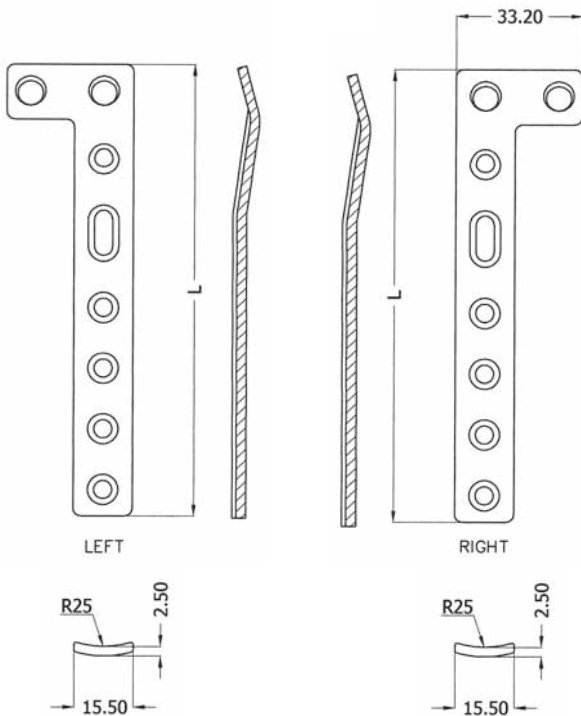

Ref. No Stainless Steel	Ref. No Titanium	Style	Holes	Length mm
ROT-229072-03 R	ROT-229072-03 RT	Right	3	72
ROT-229088-04 R	ROT-229088-04 RT	Right	4	88
ROT-229104-05 R	ROT-229104-05 RT	Right	5	104
ROT-229120-06 R	ROT-229120-06 RT	Right	6	120
ROT-229136-07 R	ROT-229136-07 RT	Right	7	136
ROT-229152-08 R	ROT-229152-08 RT	Right	8	152
ROT-229168-09 R	ROT-229168-09 RT	Right	9	168
ROT-229200-11 R	ROT-229200-11 RT	Right	11	200
ROT-229072-03 L	ROT-229072-03 LT	Left	3	72
ROT-229088-04 L	ROT-229088-04 LT	Left	4	88
ROT-229104-05 L	ROT-229104-05 LT	Left	5	104
ROT-229120-06 L	ROT-229120-06 LT	Left	6	120
ROT-229136-07 L	ROT-229136-07 LT	Left	7	136
ROT-229152-08 L	ROT-229152-08 LT	Left	8	152
ROT-229168-09 L	ROT-229168-09 LT	Left	9	168
ROT-229200-11 L	ROT-229200-11 LT	Left	11	200

Cloverleaf Plate 3.5 mm

Kleeblattplatte 3.5 mm

Plaque en trèfle 3.5 mm

Indication: The cloverleaf plate is a buttress plate designed to sit on the medial aspect of the distal tibia. It is thin and can be easily cut. The plate has a frontal wing which allows fixation to the medial malleolus. The plate can also be modified by having this frontal wing cut of which allows it use on the anterior plane of distal tibia. It should be bend pre-operatively to accurately match the contours of the segment of the bone to be fixed. And oval hole allows for temporary fixation of the plate prior to final adjustment and fixation.

Plate details: Plate is contoured during manufacture to approximate the eventual fracture site, allowing fine adjustment to be made in theatre.

Plate thickness: 1.5 mm

Plate width: 16.0 mm

Head width: 42.0 mm

Hole spacing: 16.0 mm

Screws to be used: Head of plate accept 4.0 mm small cancellous screws. Plate shaft accepts 4.5 mm cortical screws.

Material: Certified Stainless Steel according to ASTM F.138 - ISO 5832/1. Certified Titanium alloy according to ASTM F.136 - ISO 5832/3.

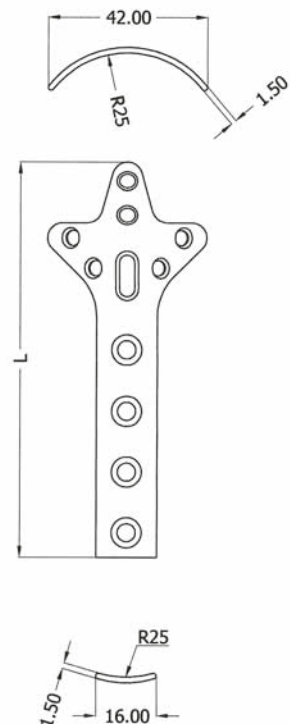

Ref. No Stainless Steel	Ref. No Titanium	Holes	Length mm
ROT-230088-03	ROT-230088-03 T	3	88
ROT-230104-04	ROT-230104-04 T	4	104
ROT-230120-05	ROT-230120-05 T	5	120
ROT-230136-06	ROT-230136-06 T	6	136
ROT-230152-07		7	152
ROT-230168-08		8	168
ROT-230184-09		9	184

Small T - Plate, 3.5 mm

Schmale T - Platte, 3.5 mm

Petite-plaque en T 3.5 mm



Indication: Used to treat distal radius fractures. Designed for both left and right side. The various configurations of T-plate allow for anatomic reduction.

Plate details: Plate profile 1.5 mm x 10.0 mm. Shaft of plate with radius. Head of plate 3 holes, right angle 10° without radius.

Plate thickness: 1.5 mm

Plate width: 10.0 mm

Head width: 23.0 mm

Hole spacing: 11.0 mm

Screws to be used: Fixation with diam. 3.5 mm small cortical screws and 4.0 mm small cancellous screws.

Material: Certified Stainless Steel according to ASTM F.138 - ISO 5832/1.

Ref. No	Holes	Length mm
Stainless Steel		
ROT-231050-03	3	50
ROT-231056-04	4	56
ROT-231072-05	5	72
ROT-231078-06	6	78

Small T - Plate, oblique 3.5 mm

Schmale T - Platte, schrägwinklig 3.5 mm

Petite-plaque en T à angle oblique 3.5 mm

Indication: Used to treat distal radius fractures. Designed for both left and right side. The various configurations of T-plate allow for anatomic reduction.

Plate details: Plate profile 1.5 mm x 10.0 mm. Shaft of plate with radius. Head of plate 3 holes, right angle 10° without radius.

Plate thickness: 1.5 mm

Plate width: 10.0 mm

Head width: 25.0 mm

Hole spacing: 10.0 mm

Screws to be used: Fixation with diam. 3.5 mm small cortical screws and 4.0 mm small cancellous screws.

Material: Certified Stainless Steel according to ASTM F.138 - ISO 5832/1. Certified Titanium alloy according to ASTM F.136 - ISO 5832/3.



Ref. No Stainless Steel	Ref. No Titanium	Holes shank	Length L mm
ROT-232052-03	ROT-232052-03 T	3	52
ROT-232062-04	ROT-232062-04 T	4	62
ROT-232072-05	ROT-232072-05 T	5	72

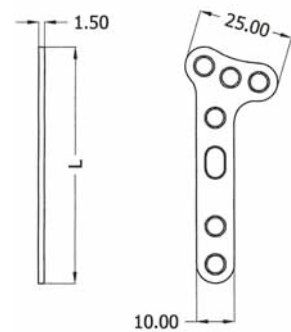



head with 4 holes

Small T-plate 3.5 mm straight

Schmale T-Platte 3.5 mm gerade

Petite-plaque en T droite

Indication: Used to treat distal radius fractures. It can be used for left and right radius. The various configurations of T-plate allow for anatomic reduction.

Plate details:

Plate profile 1.5 x 10.0 mm.

Shaft of plate with radius.

Head of plate 4 holes with radius-straight.

Plate thickness: 1.3 mm

Plate width: 10.0 mm

Head width: 31.0 mm

Hole spacing: 11.0 mm

Screws to be used: Fixation with 3.5 mm small cortical screws and 4.0 mm small cancellous screws.

Material: Certified Stainless Steel according to ASTM F.138 - ISO 5832/1. Certified Titanium alloy according to ASTM F.136 - ISO 5832/3.

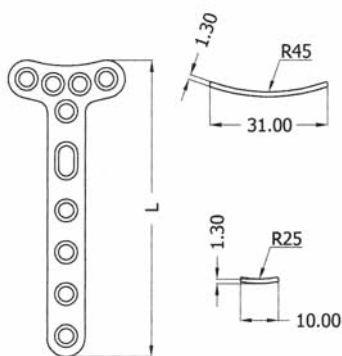

Ref. No	Ref. No	Holes	Length mm
Stainless Steel	Titan		
ROT-233056-04 4	ROT-233056-04 4 T	4	56
ROT-233078-06 4	ROT-233078-06 4 T	6	78

Small T-plate 3.5 mm straight

Schmale T-Platte 3.5 mm gerade

Petite-plaque en T droite

Indication: Used to treat distal radius fractures. It can be used for left and right radius. The various configurations of T-plate allow for anatomic reduction.

Plate details:

Plate profile 1.5 x 10.0 mm.

Shaft of plate with radius.

Head of plate 4 holes with radius-straight.

Plate thickness: 1.3 mm

Plate width: 10.0 mm

Head width: 31.0 mm

Hole spacing: 11.0 mm

Screws to be used: Fixation with 3.5 mm small cortical screws and 4.0 mm small cancellous screws.

Material: Certified Stainless Steel according to ASTM F.138 - ISO 5832/1. Certified Titanium alloy according to ASTM F.136 - ISO 5832/3.



head with 3 holes

Ref. No Stainless Steel	Ref. No Titan	Holes	Length mm
ROT-233050-03 3	ROT-233050-03 3 T	3	50
ROT-233072-05 3	ROT-233072-05 3 T	5	72

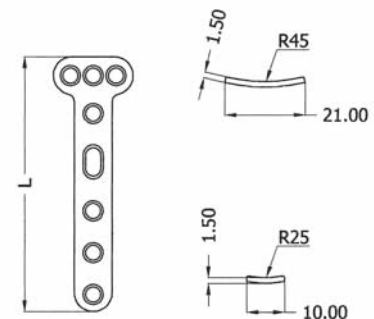

Small L and T Plate 2.7 mm

Schmale L und T Platten 2.7 mm

Petite-plaque en L et T 2.7 mm



Indication: To be used in stabilising for head of interfalangeal articulation of hand. Plates are slightly concave with right, left and oblique (T-shaped) end hole style.

Hole spacing: 8.0 mm

Screws to be used: Fixation with diam. 2.7 mm mini cortical screws.

Plate details: Plate profile with radius 1.0 mm x 7.0 mm.

Material: Certified Stainless Steel according to ASTM F.138 - ISO 5832/1. Available in titanium according to ASTM F.136 ISO 5832/3.

Plate thickness: 1.0 mm

Plate width: 5.5mm for T- Plate, 7.0 mm for L-Plate

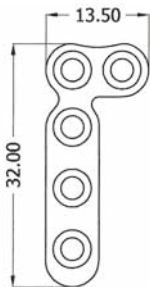
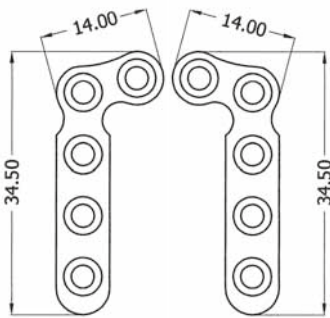

Ref. No Stainless Steel	Ref. No Titanium	Description	Holes	Length L mm	Style
ROT-234032-03	ROT-234032-03 T	T - Plate	3	32.0	
ROT-234040-04	ROT-234040-04 T	T - Plate	4	40.0	
ROT-234032-03 R	ROT-234032-03 RT	L - Plate 90°	3	32.0	Right
ROT-234032-03 L	ROT-234032-03 LT	L - Plate 90°	3	32.0	Left
ROT-234034-03 R	ROT-234034-03 RT	L - Plate 105°	3	34.5	Right
ROT-234034-03 L	ROT-234034-03 LT	L - Plate 105°	3	34.5	Left

Quarter Tubular plate 2.7 mm

Viertelrohrplatte 2.7 mm

Plaque quart de tube 2.7 mm

Indication: Used to treat small bone fractures, e.g metatarsals and metacarpals. Compression is applied by eccentric positioning of the screw against the side of the screw hole furthest from the fracture line.

Plate details: Plate profile one quarter of 12 mm diam. tube.

Plate thickness: 1.0 mm

Plate width: 7.5 mm

Hole spacing: 8.0 mm

Screws to be used: Fixation with diam. 2.7 mm mini cortical screws.

Material: Certified Stainless Steel according to ASTM F.138 - ISO 5832/1. Certified Titanium alloy according to ASTM F.136 - ISO 5832/3.



Ref. No Stainless Steel	Ref. No Titanium	Holes	Length mm
ROT-235023-03	ROT-235023-03 T	3	23
ROT-235031-04	ROT-235031-04 T	4	31
ROT-235039-05	ROT-235039-05 T	5	39
ROT-235047-06	ROT-235047-06 T	6	47
ROT-235055-07	ROT-235055-07 T	7	55
ROT-235063-08	ROT-235063-08 T	8	63
ROT-235071-09		9	71
ROT-235079-10		10	79

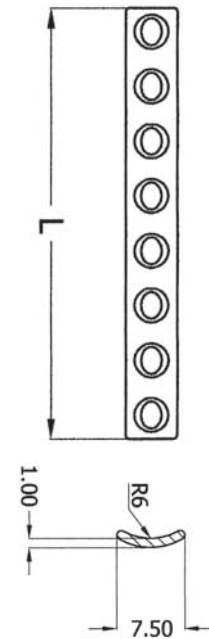

Cervical Straight Plate 3.5 mm

Halswirbelplatte gerade 3.5 mm

Plaque droties pour cervicales 3.5 mm



Indication: Used for stabilisation and somatoarthrodesis in anterior surgery of the cervical.

Screws to be used: Fixation with diam. 3.5 mm small cortical and 4.0 mm small cancellous screws.

Plate details: Plate profile with radius 4.0 mm x 10.0 mm.

Plate thickness: 4.0 mm

Plate width: 10.0 mm

Hole spacing: 13.0 mm

Material: Certified Stainless Steel according to ASTM F.138 - ISO 5832/1. Available in titanium according to ASTM F.136 ISO 5832/3.

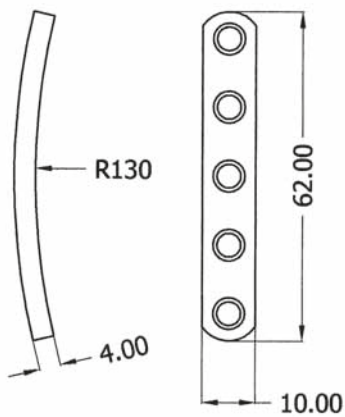

Ref. No	Holes	Length L mm	R	Thickness A mm
Stainless Steel				
ROT-236023-02	2	23.0		4
ROT-236036-03	3	36.5	R270	4
ROT-236049-04	4	49.5	R130	4
ROT-236062-05	5	62.0	R130	4
ROT-236101-08	8	101.0	R300	4
ROT-236127-10	10	127.0	R300	4

Cervical Spine H - Plate 2.7 mm

Halswirbel H - Platte 2.7 mm

Plaque en H pour cervicales 2.7 mm

Indication: The cervical spine H plate is principally used for spine arthrodeses also for calcaneus.

Material: Certified Stainless Steel according to ASTM F.138 - ISO 5832/1. Available in titanium according to ASTM F.136 ISO 5832/3.

Plate details:

Plate profile with radius 1.5 mm

Plate thickness: 1.5 mm

Plate width: 19.0 mm

Screws to be used: Fixation with diam. 2.7 mm mini cortical and 3.5 mm small corticale screws.

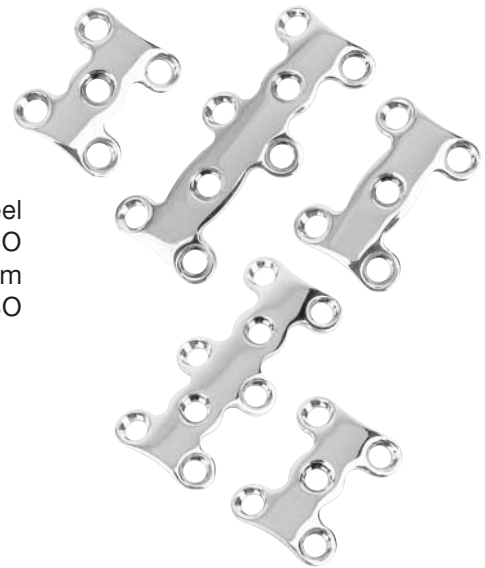

Ref. No	Holes	Length mm	Length L mm
Stainless Steel			
ROT-236023-05	5	16	23
ROT-236025-05	5	18	25
ROT-236028-05	5	21	28
ROT-236041-08	8	16+18	41
ROT-236046-08	8	18+21	46
ROT-236059-11	11	16+18+18	59

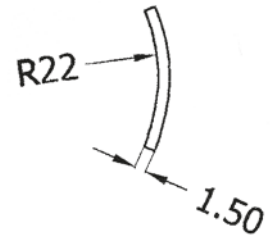
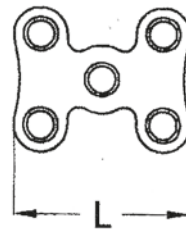



Dorsal and Lumbar Spine Plate 4.5 mm

Dorso - Lumbar Wirbelsäulenplatte 4.5 mm

Plaque pour dorso-lombaires 4.5 mm

Indication: The design of the posterior plates comes from spine anatomy. The average distance between two adjacent pedicles is 26 mm. The plates are created with holes every 13 mm. It is therefore possible to fix two adjacent vertebrae with a pedicular screw every two holes. The plates are curved similar to the normal spine at thoracolumbar junction, which is the most common site of fracture. The holes are reinforced by an embossment giving to the plates and homogeneous resistance. They are produced from stainless steel. These plates can be bend if necessary. Different lengths, ranging from 49 mm to 218 mm with 4 to 17 holes have been designed.

Plate details:

Plate profile 7.2 x 10.0 mm

Plate thickness: 7.2 mm

Plate width: 10.0 mm

Hole spacing: 13.0 mm

Screws to be used: Fixation with diam. 4.5 mm cortical and 3.5 mm small cortical screws.

Material: Certified Stainless Steel according to ASTM F.138 - ISO 5832/1.

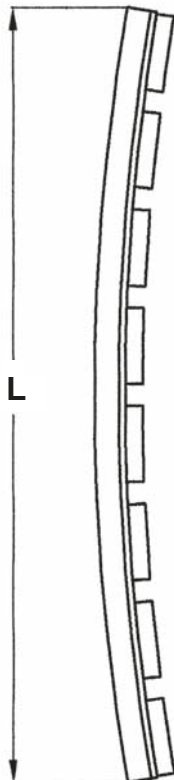

Ref. No	Holes	Length mm
Stainless Steel		
ROT-237049-04	4	49
ROT-237062-05	5	62
ROT-237088-07	7	88
ROT-237114-09	9	114
ROT-237140-11	11	140
ROT-237166-13	13	166
ROT-237192-15	15	192
ROT-237218-17	17	218

Cobra Head Plate 4.5 mm

Kreuzplatte 4.5 mm

Plaque à croix 4.5 mm

Indication: Used when an arthrodesis of the hip is to be performed. 6.5 mm cancellous screws are used through the proximal fixation holes into the femoral head. The plate is then secured to the femoral shaft with 4.5 mm cortical screws.

Plate details: The cobra head plates are manufactured from relatively thicker material than the other standard plates. Design and hardness of this plate allows secure fixation.

Plate thickness: 6.0 mm

Plate width: 16.0 mm

Head width: 40.0 mm

Hole spacing: 16.0 mm

Screws to be used: Head of plate accept 6.5 mm cancellous screws. Plate shaft accepts 4.5 mm cortical screws. Cancellous screws are recommended for the head of the plate.

Material: Certified Stainless Steel according to ASTM F.138 - ISO 5832/1.

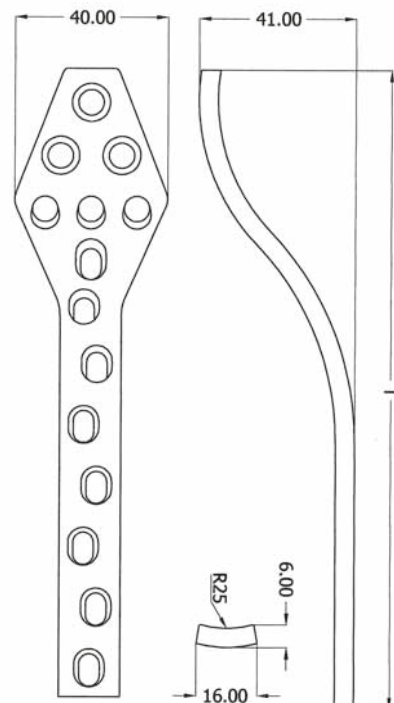

Ref. No	Holes	Length mm
DCP Holes		
ROT-238170-08 D	8	170
ROT-238186-09 D	9	186
ROT-238202-10 D	10	202
ROT-238218-11 D	11	218



Condylar Buttress Plate 4.5 mm

Kondylenabstützplatte 4.5 mm

Plaque de soutien condyliennes 4.5 mm

Indication: The condylar buttress plate have been designed to be used for the fractures of distal femur. They come in a right and a left version. They are heavier and stronger than all other buttress plates since they have to withstand much greater forces.

Plate details: The condylar buttress plates are manufactured from relatively thicker material than the other standard plates. Design and hardness of this plate allows secure fixation.

Plate thickness: 5.00 mm

Plate width: 16.00 mm

Head width: 48.25 mm

Hole spacing: 16.00 mm to shaft

Screws to be used: Head of plate accept 6.5 mm cancellous screws. Plate shaft accepts 4.5 mm cortical screws. Cancellous screws are recommended for the head of the plate.

Material: Certified Stainless Steel according to ASTM F.138 - ISO 5832/1.

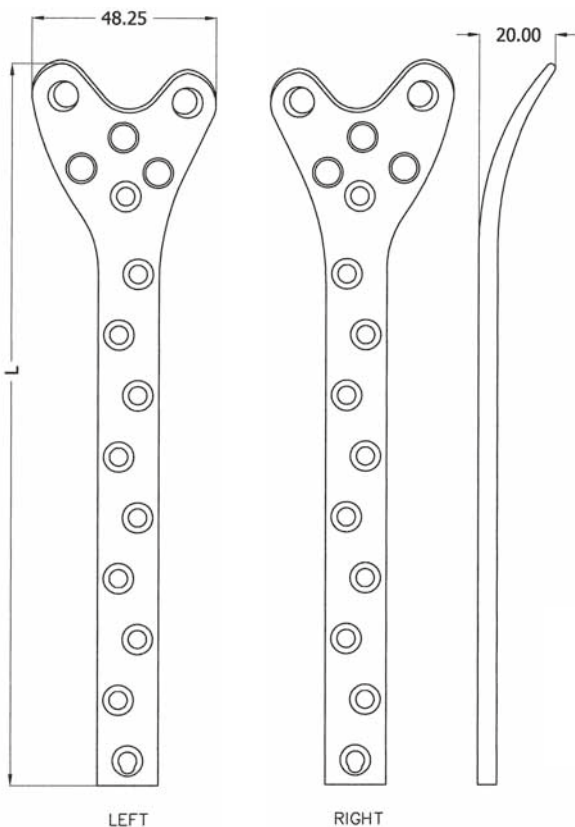

Ref. No Stainless Steel	Ref. No Round Holes	Style	Holes	Length mm
ROT-239154-07 RD	ROT-239154-07 R	Right	7	154
ROT-239186-09 RD	ROT-239186-09 R	Right	9	186
ROT-239218-11 RD	ROT-239218-11 R	Right	11	218
ROT-239250-13 RD	ROT-239250-13 R	Right	13	250
ROT-239282-15 RD		Right	15	282
ROT-239154-07 LD	ROT-239154-07 L	Left	7	154
ROT-239186-09 LD	ROT-239186-09 L	Left	9	186
ROT-239218-11 LD	ROT-239218-11 L	Left	11	218
ROT-239250-13 LD	ROT-239250-13 L	Left	13	250
ROT-239282-15 LD		Left	15	282

In Titanium on request.

Lateral Tibial Head Buttress Plate 4.5 mm

Laterale Tibiakopfabstützplatte 4.5 mm

Plaque de soutien latérale pour plateau tibial 4.5 mm

Indication: The lateral tibial head plate is designed as a buttress plate of the lateral tibial plateau. Available with various holes. The head of this plate is shifted either left or right to allow for alternative screws placement.

Screws to be used: Head of plate accept 6.5 mm cancellous screws. Plate shaft accepts 4.5 mm cortical screws. Shaft with DCP dynamic compression holes and slots for tension device.

Right angle plate for **left** leg.

Left angle plate for **right** leg.

Plate details: Plate profile 145 mm x 4.0 mm

Plate thickness: 5.0 mm

Plate width: 14.0 mm

Head width: 23.6 mm

Hole spacing: 16.0 mm

Material: Certified Stainless Steel according to ASTM F.138 - ISO 5832/1.

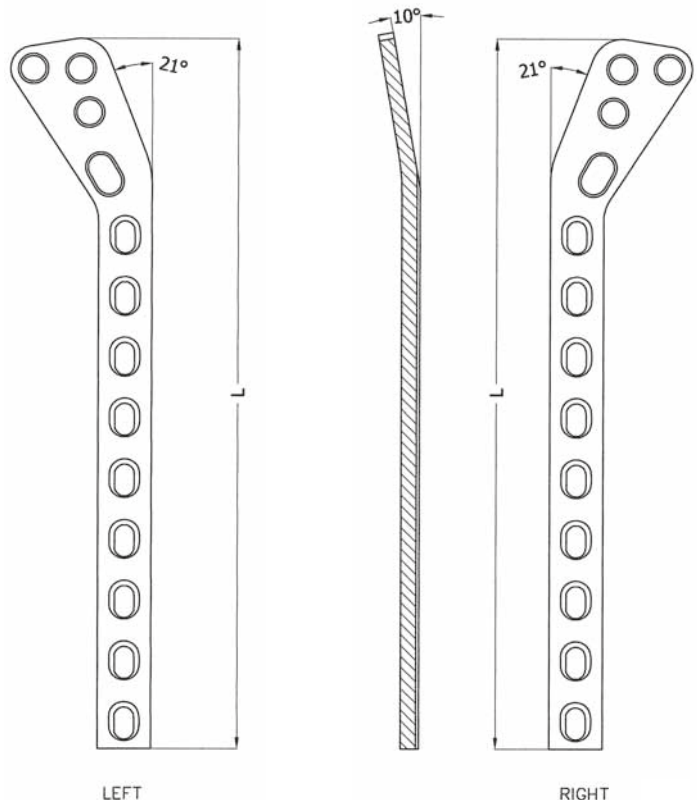
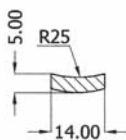

Ref. No	Style	Holes	Length mm
DCP Holes			
ROT-240118-05 RD	Right	5	118
ROT-240150-07 RD	Right	7	150
ROT-240182-09 RD	Right	9	182
ROT-240214-11 RD	Right	11	214
ROT-240246-13 RD	Right	13	246
ROT-240118-05 LD	Left	5	118
ROT-240150-07 LD	Left	7	150
ROT-240182-09 LD	Left	9	182
ROT-240214-11 LD	Left	11	214
ROT-240246-13 LD	Left	13	246

In Titanium on request.



Distal Tibia Plate 4.5 mm

Distale Tibiplatte 4.5 mm

Plaque pour tibia distal 4.5 mm

Indication: Anatomical distal tibia bone plates are designed to be used for reducing fractures of the distal tibia. It is designed to sit on the distal aspect of the tibia. The anatomical bone plate features show the following important factors to osteosynthesis as; permit a stable fixation of the small proximal and distal fragments. They consider the various physiological stability factors of distal spongiosa and meta-to diaphyseal fractures. They are curved and twisted to conform to the nature shape of the proximal and distal bones areas. They simplify reduction in case of extended fractures as their anterior surface is contoured to minimize tissue irritation.

Plate thickness: 3.0 mm

Plate width: 17.0 mm

Head width: 24.5 mm

Hole spacing: 18.0 mm

Screws to be used: Head of plate accept 6.5 mm cancellous screws. Plate shaft accepts 4.5 mm cortical screws. The screw holes into distal and are placed so as to allow cancellous screw to be placed in different directions. Two small holes at the very end of the plate are for temporary fixation with kirschner wires. An oval hole in the proximal part of the plate permit fixation with an eccentrically or medially placed cortical screw while allowing enough room for application of a compression device.

Plate details: To conform to the ventro-tibial contours of the distal tibia, the plate is twisted and curved and has a concave surface on its bone side and broadened distal end. The pre-form shape of the plate requires that a separate plate to be used for right and left tibia.

Material: Certified Stainless Steel according to ASTM F.138 - ISO 5832/1.

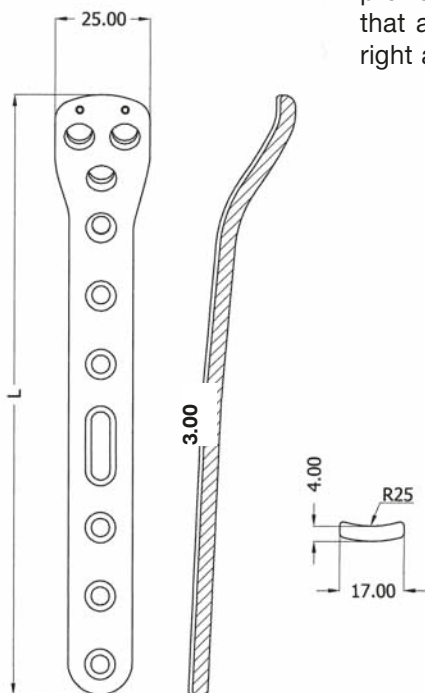

Ref. No	Style	Holes	Length mm
Stainless Steel			
ROT-241080-05 R	Right	5	80
ROT-241122-07 R	Right	7	122
ROT-241158-09 R	Right	9	158
ROT-241194-11 R	Right	11	194
ROT-241230-13 R	Right	13	230
ROT-241086-05 L	Left	5	86
ROT-241122-07 L	Left	7	122
ROT-241158-09 L	Left	9	158
ROT-241194-11 L	Left	11	194
ROT-241230-13 L	Left	13	230

In Titanium on request.

Lateral Proximal Tibia Plate 4.5 mm

Laterale - Proximale Tibiplatte 4.5 mm

Plaque pour tibia latérale proximal 4.5 mm

Indication: Anatomical lateral proximal tibia bone plates are designed to be used for reducing fractures of the proximal tibia. These plates are indicated where the shape of the fracture or the soft tissue problems do not make plate attachment to the medial tibial surface advisable. It is designed to sit on the lateral aspect of the proximal tibia. The anatomical bone plate features show the following important factors to osteosynthesis as; permit a stable fixation of the small proximal and distal fragments. They consider the various physiological stability factors of distal spongiosa and meta-to diaphyseal fractures. They are curved and twisted to conform to the nature shape of the proximal and distal bones areas. They simplify reduction in case of extended fractures as their anterior surface is contoured to minimize tissue irritation.

an has a concav surface on its bone side and broadened distal end. The pre-form shape of the plate requires that a separate plate to be used for right and left tibia.

Plate thickness: 3.0 mm

Plate width: 17.0 mm

Head width: 24.5 mm

Hole spacing: 18.0 mm

Screws to be used: Head of plate accept 6.5 mm cancellous screws. Plate shaft accepts 4.5 mm cortical screws. The screw holes into distal and are placed so as to allow cancellous screw to be placed in different directions. Two small holes at the very end of the plate are for temporary fixation with kirschner wires. An oval hole in the proximal part of the plate permit fixation with an excentrically or medially placed cortical screw while allowing enough room for application of a compression device.

Plate details: To conform to the ventro-tibial contours of the proximal tibia, the plate is twisted and curved

Material: Certified Stainless Steel according to ASTM F.138 - ISO 5832/1.

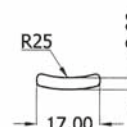
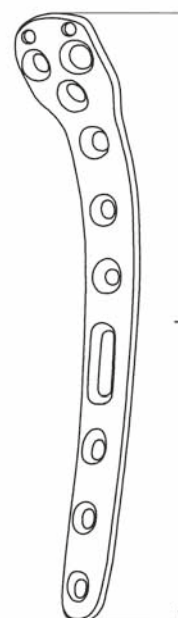

Ref. No	Style	Holes	Length mm
Stainless Steel			
ROT-242080-05 R	Right	5	80
ROT-242122-07 R	Right	7	122
ROT-242158-09 R	Right	9	158
ROT-242194-11 R	Right	11	194
ROT-242230-13 R	Right	13	230
ROT-242080-05 L	Left	5	80
ROT-242122-07 L	Left	7	122
ROT-242158-09 L	Left	9	158
ROT-242194-11 L	Left	11	194
ROT-242230-13 L	Left	13	230

In Titanium on request.



Medial Proximal Tibia Plate 4.5 mm

Mediale - Proximale Tibiplatte 4.5 mm

Plaque pour tibia medial proximal 4.5 mm

Indication: Anatomical lateral proximal tibia bone plates are designed to be used for reducing fractures of the proximal tibia. These plates are indicated where the shape of the fracture or the soft tissue problems do not make plate attachment to the lateral tibial surface advisable. It is designed to sit on the medial aspect of the proximal tibia. The anatomical bone plate features show the following important factors to osteosynthesis as; permit a stable fixation of the small proximal and distal fragments. They consider the various physiological stability factors of distal spongiosa and meta-to diaphyseal fractures. They are curved and twisted to conform to the nature shape of the proximal and distal bones areas. They simplify reduction in case of extended fractures as their anterior surface is contoured to minimize tissue irritation.

an has a concav surface on its bone side and broadened distal end. The pre-form shape of the plate requires that a separate plate to be used for right and left tibia.

Plate thickness: 3.0 mm

Plate width: 17.0 mm

Head width: 24.5 mm

Hole spacing: 18.0 mm

Screws to be used: Head of plate accept 6.5 mm cancellous screws. Plate shaft accepts 4.5 mm cortical screws. The screw holes into distal and are placed so as to allow cancellous screw to be placed in different directions. Two small holes at the very end of the plate are for temporary fixation with kirschner wires. An oval hole in the proximal part of the plate permit fixation with an eccentrically or medially placed cortical screw while allowing enough room for application of a compression device.

Plate details: To conform to the ventro-tibial contours of the proximal tibia, the plate is twisted and curved

Material: Certified Stainless Steel according to ASTM F.138 - ISO 5832/1.

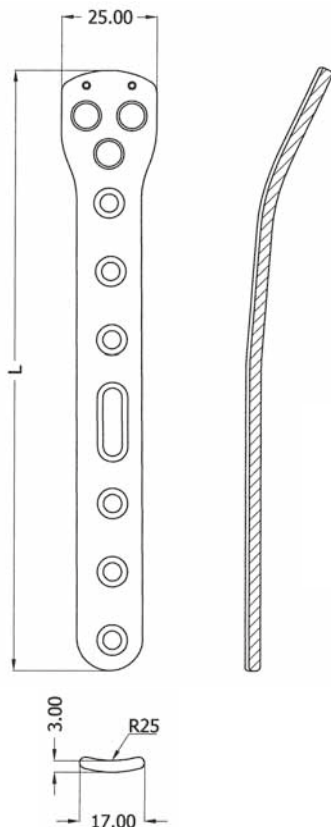

Ref. No	Style	Holes	Length mm
Stainless Steel			
ROT-243086-05 R	Right	5	86
ROT-243122-07 R	Right	7	122
ROT-243158-09 R	Right	9	158
ROT-243194-11 R	Right	11	194
ROT-243230-13 R	Right	13	230
ROT-243086-05 L	Left	5	86
ROT-243122-07 L	Left	7	122
ROT-243158-09 L	Left	9	158
ROT-243194-11 L	Left	11	194
ROT-243230-13 L	Left	13	230

Fibular Distal Plate 4.5 mm

Distale Fibulare Tibiaplatte 4.5 mm

Plaque pour perone distal 4.5 mm

Indication: Anatomical fibular distal tibia bone plates are designed to be used for reducing fractures of the distal tibia. These plates are indicated where the shape of the fracture or soft tissue problems do not make plate attachment to the medial tibial surface advisable. The anatomical bone plate features show the following important factors to osteosynthesis as; permit a stable fixation of the small proximal and distal fragments. They consider the various physiological stability factors of distal spongiosa and meta-to diaphyseal fractures. They are curved and twisted to conform to the nature shape of the proximal and distal bones areas. They simplify reduction in case of extended fractures as their anterior surface is contoured to minimize tissue irritation.

Plate details: To conform to the ventro-tibial contours of the fibular distal tibia, the plate is twisted and curved and has a concave surface

on its bone site and broadened distal end. The pre-formed shape of the plate requires that a separate plate to be used for right and left tibia.

Plate thickness: 3.0 mm

Plate width: 17.0 mm

Head width: 24.5 mm

Hole spacing: 18.0 mm

Screws to be used: Head of plate accept 6.5 mm cancellous screws. Plate shaft accepts 4.5 mm cortical screws. The screw holes into distal and are placed so as to allow cancellous screw to be placed in different directions. Two small holes at the very end of the plate are for temporary fixation with kirschner wires. An oval hole in the proximal part of the plate permit fixation with an eccentrically or medially placed cortical screw while allowing enough room for application of a compression device.

Material: Certified Stainless Steel according to ASTM F.138 - ISO 5832/1.

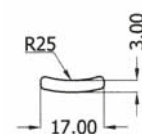
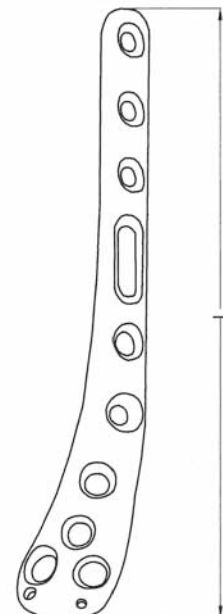

Ref. No	Style	Holes	Length mm
Stainless Steel			
ROT-244122-07 R	Right	7	122
ROT-244158-09 R	Right	9	158
ROT-244194-11 R	Right	11	194
ROT-244230-13 R	Right	13	230
ROT-244122-07 L	Left	7	122
ROT-244158-09 L	Left	9	158
ROT-244194-11 L	Left	11	194
ROT-244230-13 L	Left	13	230

In Titanium on request.



Distal Femur Plate 4.5 mm

Distal Femur Platte 4.5 mm

Plaque pour femur distal 4.5 mm

Indication: Anatomical distal femur bone plates are designed to be used for reducing fractures of the distal femur with or without involvement of the joint. The anatomical bone plate features show the following important factors to osteosynthesis as; permit a stable fixation of the small proximal and distal fragments. They consider the various physiological stability factors of distal spongiosa and meta-to diaphyseal fractures. They are curved and twisted to conform to the nature shape of the proximal and distal bones areas. They simplify reduction in case of extended fractures as their anterior surface is contoured to minimize tissue irritation.

Plate details: The shape of distal femur bone plate is particularly well suited for accommodating the ventral convex curve of the normal femur, as well as its specific twisting. The plate thickness is reduced towards the distal direction in accordance with the different stability

relationship of diaphysis to metaphysis. The pre-formed shape of the plate requires that a separate plate to be used for right and left femur.

Plate thickness: 5.0 mm

Plate width: 16.0 mm

Head width: 25.5 mm

Hole spacing: 18.0 mm

Screws to be used: Head of plate accept 6.5 mm cancellous screws. Plate shaft accepts 4.5 mm cortical screws. The screw holes into distal and are placed so as to allow cancellous screw to be placed in different directions. Two small holes at the very end of the plate are for temporary fixation with kirschner wires. An oval hole in the proximal part of the plate permit fixation with an eccentrically or medially placed cortical screw while allowing enough room for application of a compression device.

Material: Certified Stainless Steel according to ASTM F.138 - ISO 5832/1.

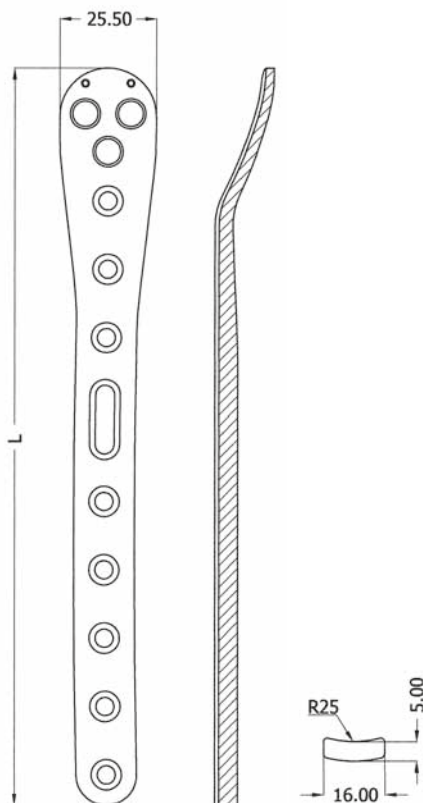

Ref. No	Style	Holes	Length mm
Stainless Steel			
ROT-245080-05 R	Right	5	80
ROT-245122-07 R	Right	7	122
ROT-245158-09 R	Right	9	158
ROT-245194-11 R	Right	11	194
ROT-245230-13 R	Right	13	230
ROT-245080-05 L	Left	5	80
ROT-245122-07 L	Left	7	122
ROT-245158-09 L	Left	9	158
ROT-245194-11 L	Left	11	194
ROT-245230-13 L	Left	13	230

In Titanium on request.

Proximal Femur Plate 4.5 mm

Proximale Femur Platte 4.5 mm

Plaque pour femur proximal 4.5 mm

Indication: Anatomical proximal femur bone plates are designed to be used for reducing fractures of the proximal femur with or without involvement of the joint. The anatomical bone plate features show the following important factors to osteosynthesis as; permit a stable fixation of the small proximal and distal fragments. They consider the various physiological stability factors of distal spongiosa and meta-to diaphyseal fractures. They are curved and twisted to conform to the nature shape of the proximal and distal bones areas. They simplify reduction in case of extended fractures as their anterior surface is contoured to minimize tissue irritation.

Plate details: The shape of proximal femur bone plate is particularly well suited for accomodating the ventral convex curve of the normal femur, as well as its specific twisting. The plate thickness is reduced towards the distal direction in accordance with the different stability relationship

of diaphysis to metaphysis. The preformed shape of the plate requires that a separate plate to be used for right and left femur.

Plate thickness: 5.0 mm

Plate width: 16.0 mm

Head width: 25.5 mm

Hole spacing: 18.0 mm

Screws to be used: Head of plate accept 6.5 mm cancellous screws. Plate shaft accepts 4.5 mm cortical screws. The screw holes into distal and are placed so as to allow cancellous screw to be placed in different directions. Two small holes at the very end of the plate are for temporary fixation with kirschner wires. An oval hole in the proximal part of the plate permit fixation with an excentrically or medially placed cortical screw while allowing enough room for application of a compression device.

Material: Certified Stainless Steel according to ASTM F.138 - ISO 5832/1.

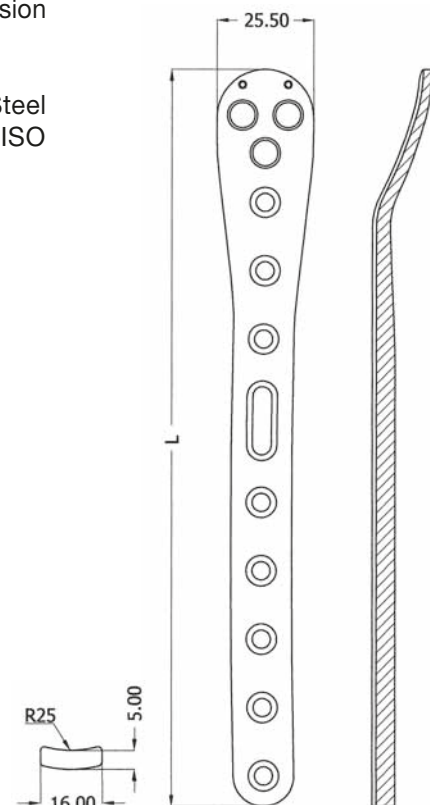

Ref. No	Style	Holes	Length mm
Stainless Steel			
ROT-246086-05 R	Right	5	86
ROT-246122-07 R	Right	7	122
ROT-246158-09 R	Right	9	158
ROT-246194-11 R	Right	11	194
ROT-246230-13 R	Right	13	230
ROT-246086-05 L	Left	5	86
ROT-246122-07 L	Left	7	122
ROT-246158-09 L	Left	9	158
ROT-246194-11 L	Left	11	194
ROT-246230-13 L	Left	13	230



Mini L and T Plate 2.0 mm

Mini L und T Platten 2.0 mm

Mini-plaque en L et T 2.0 mm

Indication: To be used in fixation of fractures in small bones primarily for finger joint head and foot.

Screws to be used: Fixation with diam. 2.0 mm mini cortical screws.

Plate details: Plate profile with radius 1.0 mm x 5.0 mm.

Material: Certified Stainless Steel according to ASTM F.138 - ISO 5832/1. Certified Titanium alloy according to ASTM F.136 - ISO 5832/3.

Plate thickness: 1.0 mm

Plate width: 5.0 mm

Hole spacing: 6.0 mm

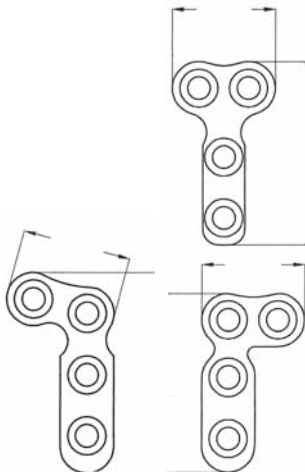

Ref. No	Ref. No	Description	Holes	Style
Stainless Steel	Titanium			
ROT-247018-02	ROT-247018-02 T	T - Plate	2	
ROT-247050-03	ROT-247050-03 T	T - Plate	3	
ROT-247050-04	ROT-247050-04 T	T - Plate	4	
ROT-247018-02 R	ROT-247018-02 RT	L - Plate 90°	2	Right
ROT-247018-02 L	ROT-247018-02 LT	L - Plate 90°	2	Left
ROT-247019-02 R	ROT-247019-02 RT	L - Plate 110°	2	Right
ROT-247019-02 L	ROT-247019-02 LT	L - Plate 110°	2	Left

Mini Fragment Plate 2.0 mm

Minifragmentplatte 2.0 mm

Mini - plaque à compression 2.0 mm

Indication: For fractures of the phalanx. **Material:** Certified Stainless Steel according to ASTM F.138 - ISO 5832/1. Certified Titanium alloy according to ASTM F.136 - ISO 5832/3.

Plate details:

Plate thickness: 1.0 mm

Plate width: 5.0 mm

Hole spacing: 5.0 mm

Screws to be used: Fixation with diam. 2.0 mm mini cortical screws.



Ref. No Stainless Steel	Ref. No Titanium	Holes	Length mm
ROT-247017-03	ROT-247017-03 T	3	17
ROT-247023-04	ROT-247023-04 T	4	23
ROT-247029-05	ROT-247029-05 T	5	29
ROT-247035-06	ROT-247035-06 T	6	35
ROT-247100-20	ROT-247100-20 T	20	100

Self compressing plates for screws 2.0 mm

Spanngleitlochplatten für Schrauben 2.0 mm

Ref. No Stainless Steel	Ref. No Titanium	Holes	Length mm
ROT-247022-04	ROT-247022-04 T	4	22
ROT-247027-05	ROT-247027-05 T	5	27
ROT-247032-06	ROT-247032-06 T	6	32
ROT-247037-07	ROT-247037-07 T	7	37
ROT-247042-08	ROT-247042-08 T	8	42





Mini plate straight for screws 1.5 mm

Miniplatten gerade für Schrauben 1.5 mm

Indication: For fractures of the phalanx.

Material: Certified Stainless Steel according to ASTM F.138 - ISO 5832/1. Certified Titanium alloy according to ASTM F.136 - ISO 5832/3.

Plate details:

Plate thickness: 0.9 mm

Plate width: 3.8 mm

Hole spacing: 5.0 mm

Screws to be used: Fixation with diam. 1.5 mm mini cortical screws.

Ref. No	Ref. No	Holes	Length
Stainless Steel	Titanium		mm
ROT-248100-20	ROT-248100-20 T	20	100

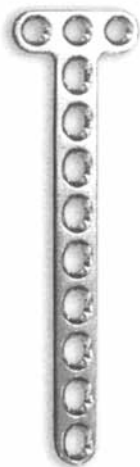

T-plates for screws 1.5 mm, shaft with 9 holes

T-Platten für Schrauben 1.5 mm, Schaft mit 9 Löchern

Ref. No	Ref. No	Holes	Length
Stainless Steel	Titanium		mm
ROT-248050-03	ROT-248050-03 T	3	50
ROT-248050-04	ROT-248050-04 T	4	50

Angle stable 4 hole plates, right, for distal radius

Winkelstabile 4-Loch Platten, rechts, für distalen Radius

Indication: For fractures of the phalanx. **Material:** Certified Stainless Steel according to ASTM F.138 - ISO 5832/1. Certified Titanium alloy according to ASTM F.136 - ISO 5832/3.

Plate details:

Plate thickness: 1.5 mm

Plate width head: 26.5 mm

Plate width shank: 9.0 mm

Hole spacing: 8.0 mm

Screws to be used: Fixation with diam. 1.5 mm mini cortical screws.



Ref. No	Holes
Titanium	
ROT-250-02 RT	2
ROT-250-04 RT	4
ROT-250-08 RT	8

Angle stable 4 hole plates, left, for distal radius

Winkelstabile 4-Loch Platten, links, für distalen Radius

Ref. No	Holes
Titanium	
ROT-250-02 LT	2
ROT-250-04 LT	4
ROT-250-08 LT	8





Angle stable PEDUS-O plate

Winkelstabile PEDUS-O Platte

Indication: Hallux valgus, Inter-metatarsal angle > 12°.

Material: Certified Stainless Steel according to ASTM F.138 - ISO 5832/1. Certified Titanium alloy according to ASTM F.136 - ISO 5832/3.

Plate details:

Plate thickness: 1.1 mm

Screws to be used: Fixation with angle stable cortical screws Ø 2.3 mm.

Ref. No	Holes
Titanium	
ROT-260-00 T	0
ROT-260-02 T	2
ROT-260-03 T	3
ROT-260-04 T	4
ROT-260-05 T	5



Angle stable PEDUS-U plate

Winkelstabile PEDUS-U Platte

Indication: Arthrodesis of the tarso-metatarsals joint.

Material: Certified Stainless Steel according to ASTM F.138 - ISO 5832/1. Certified Titanium alloy according to ASTM F.136 - ISO 5832/3.

Plate details:

Plate thickness: 1.1 mm

Screws to be used: Fixation with angle stable cortical screws Ø 2.3 mm.

Ref. No	Holes
Titanium	
ROT-261-12 T	12
ROT-261-14 T	14
ROT-261-16 T	16
ROT-261-18 T	18
ROT-261-20 T	20

Calcaneal plate for screws 3.5 mm / 4.0 mm

Clacaneusplatte für Schrauben 3.5 mm / 4.0 mm

Indication: Angle stable cortical screw
 Ø 2.3 mm. Cortical screws Ø 2.3 mm.

Plate details:

Plate thickness: 1.2 mm

Screws to be used: Cortical screws
 Ø 3.5 mm and Cancellous screws
 Ø 4.0 mm.

Material: Certified Stainless Steel
 according to ASTM F.138 - ISO
 5832/1. Certified Titanium alloy
 according to ASTM F.136 - ISO
 5832/3.



Ref. No Stainless Steel	Ref. No Titanium	Length mm
ROT-262-60	ROT-262-60 T	60
ROT-262-70	ROT-262-70 T	70



Angled Blade Plates 130° for Adults

Winkelplatte 130° für Erwachsene

Plaques coudée 130° pour adultes

Indication: The 130° angled blade plate is principally used for femoral neck and pertrochanteric fractures. It is designed to perform reconstructive osteotomies.

Plate details: These plates have an angle of 130° between blade and shaft. Shaft profile is similar to broad plate. Length of blade measured on inner side. All plates are slotted to accept a tension device.

Plate thickness: 6.4 mm

Plate width: 16.0 mm

Hole spacing: 16.0 mm

U-Profile blade: 16.0 mm - 6.4 mm

Screws to be used: Fixation with diam. 4.5 mm cortical screws and proximal two holes next to the blade are suitable for 6.5 mm cancellous screws.

Material: Certified Stainless Steel according to ASTM F.138 - ISO 5832/1.

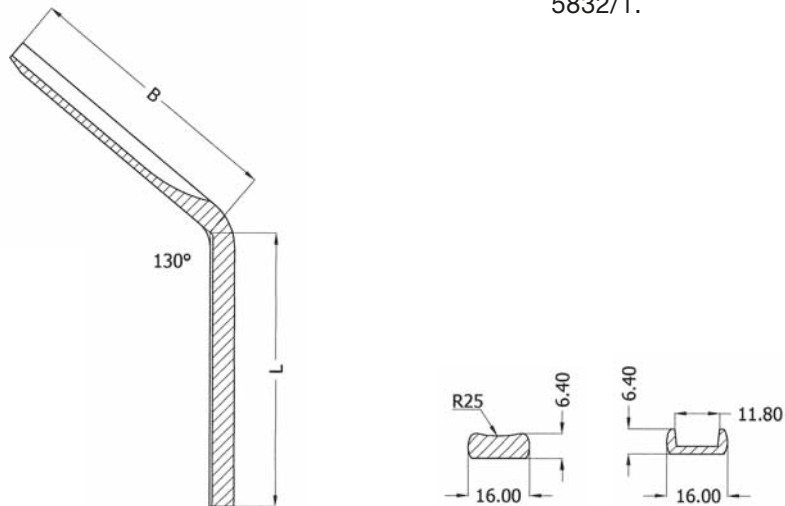

Description		Length of Shaft (mm)					
		Ref. No ROT-301					
Length of Blade (mm)	Holes	4	6	9	12	18	20
				72	104	152	200
50		050-04 D	050-06 D				
60		060-04 D	060-06 D				
70		070-04 D	070-06 D	070-09 D	070-12 D	070-18 D	070-20 D
75		075-04 D					
80		080-04 D	080-06 D	080-09 D	080-12 D		
85		085-04 D					
90		090-04 D	090-06 D	090-09 D	090-12 D		
95		095-04 D					
100		100-04 D					
105		105-04 D					
110		110-04 D					

Condylar Plate 95° for Adults

Kondylenplatte 95° für Erwachsene

Plaques condyliennes 95° pour adultes

Indication: The 95° angled blade plate is principally used for fractures in distal and proximal femur area intertrochanteric valgisation osteotomy. It is designed to perform reconstructive osteotomies.

Plate details: These plates have an angle of 95° between blade and shaft. Shaft profile is similar to broad plate. Length of blade measured on inner side. All plates are slotted to accept a tension device.

Plate thickness: 6.4 mm

Plate width: 16.0 mm

Hole spacing: 16.0 mm

U-Profile blade: 16.0 mm - 6.4 mm

Screws to be used: Fixation with diam. 4.5 mm cortical screws and proximal two holes next to the blade are suitable for 6.5 mm cancellous screws.

Material: Certified Stainless Steel according to ASTM F.138 - ISO 5832/1.

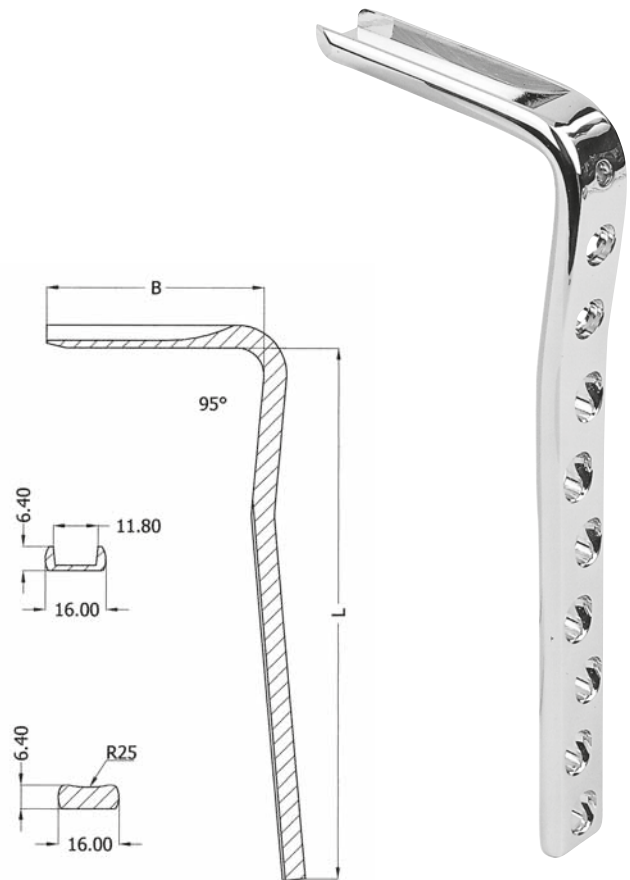

Description		Length of Shaft (mm)						
		Ref. No ROT-302						
Length of Blade (mm)	Holes	5	7	9	12	14	16	18
		DCP	92	124	156	204	234	266
50		050-05 D	050-07 D	050-09 D	050-12 D	050-14 D	050-16 D	050-18 D
60		060-05 D	060-07 D	060-09 D	060-12 D	060-14 D	060-16 D	060-18 D
70		070-05 D	070-07 D	070-09 D	070-12 D	070-14 D	070-16 D	070-18 D
80		080-05 D	080-07 D	080-09 D	080-12 D	080-14 D	080-16 D	080-18 D



Angled blade plates for intertrochanteric femoral osteotomies in adults (110°-120°-130°)

Winkelplatten für intertrochantäre Femurosteotomien für Erwachsene (110°-120°-130°)

Plaques coudée pour ostéotomies intertrochantériennes du fémur chez l'adulte (110°-120°-130°)

Indication: This plate is principally used for repositioning osteotomies in the treatment of femoral neck pseudoarthroses and fracture in adults.

Plate details: These plates have three different angle of 110°-120°-130° between blade and shaft. Shaft with dynamic compression holes or round holes. Length of blade measured on inner side. All plates are slotted to accept a tension device.

Plate thickness: 6.4 mm

Plate width: 16.0 mm

Hole spacing: 16.0 mm

U-Profile blade: 16.0 mm - 6.4 mm

Screws to be used: Fixation with 4.5 mm cortical screws. The hole in the bend enables fixation of the calcar femoris with a long cortex.

Material: Certified Stainless Steel according to ASTM F.138 - ISO 5832/1.

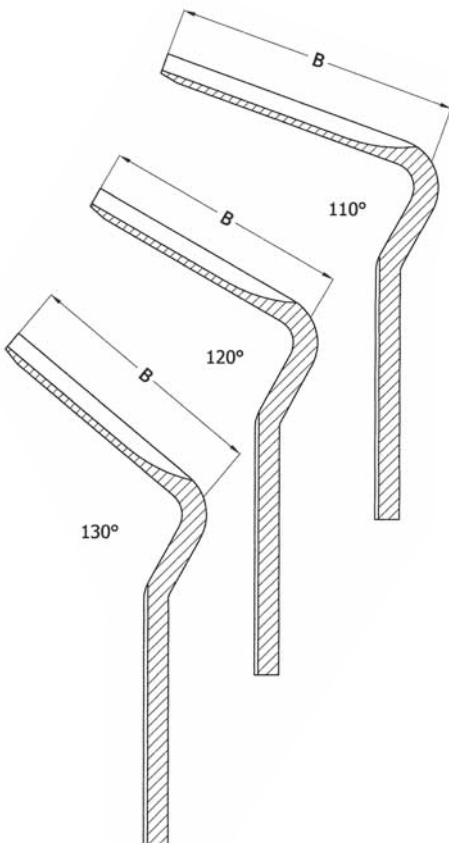
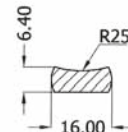
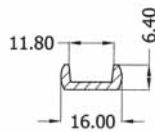

Hole Type	Holes	Length of blade mm
DCP		
110°		
ROT-303110-65 D	4	65
ROT-303110-75 D	4	75
ROT-303110-85 D	4	85
120°		
ROT-303120-65 D	4	65
ROT-303120-75 D	4	75
ROT-303120-85 D	4	85
130°		
ROT-303130-65 D	4	65
ROT-303130-70 D	4	70
ROT-303130-75 D	4	75
ROT-303130-80 D	4	80
ROT-303130-85 D	4	85
ROT-303130-90 D	4	90
ROT-303130-95 D	4	95
ROT-303130-100 D	4	100
ROT-303130-105 D	4	105
ROT-303130-110 D	4	110

Angled blade plates for intertrochanteric femoral osteotomies in adults (90°-100°)

Winkelplatten für intertrochantäre Femurosteotomien für Erwachsene (90°-100°)

Plaques coudée pour ostéotomies intertrochantériennes du fémur chez l'adulte (90°-100°)

Indication: This plate is principally used for intertrochanteric femoral osteotomies in adults.

Screws to be used: Fixation with 4.5 mm cortical screws. The hole in the bend enables fixation of the calcar femoris with a long cortex.

Plate details: These plates have two different angle of 90°-100° between blade and shaft. Shaft with 4 dynamic compression holes or round holes. Length of blade measured on inner side. All plates are slotted to accept a tension device.

Material: Certified Stainless Steel according to ASTM F.138 - ISO 5832/1.

Plate thickness: 6.4 mm

Plate width: 16.0 mm

Hole spacing: 16.0 mm

U-Profile blade: 16.0 mm - 6.4 mm



Hole Type	Holes	Length of blade mm	Displacement mm
DCP			
90°			
ROT-304950-20 D	4	50	20
ROT-304960-20 D	4	60	20
ROT-304970-20 D	4	70	20
ROT-304940-15 D	4	40	15
ROT-304950-15 D	4	50	15
ROT-304955-15 D	4	55	15
ROT-304960-15 D	4	60	15
ROT-304965-15 D	4	65	15
ROT-304970-15 D	4	70	15
ROT-304940-10 D	4	40	10
ROT-304950-10 D	4	50	10
ROT-304955-10 D	4	55	10
ROT-304960-10 D	4	60	10
ROT-304965-10 D	4	65	10
ROT-304970-10 D	4	70	10
ROT-304980-10 D	4	80	10
100°			
ROT-304050-10 D	4	50	10
ROT-304060-10 D	4	60	10
ROT-304070-10 D	4	70	10

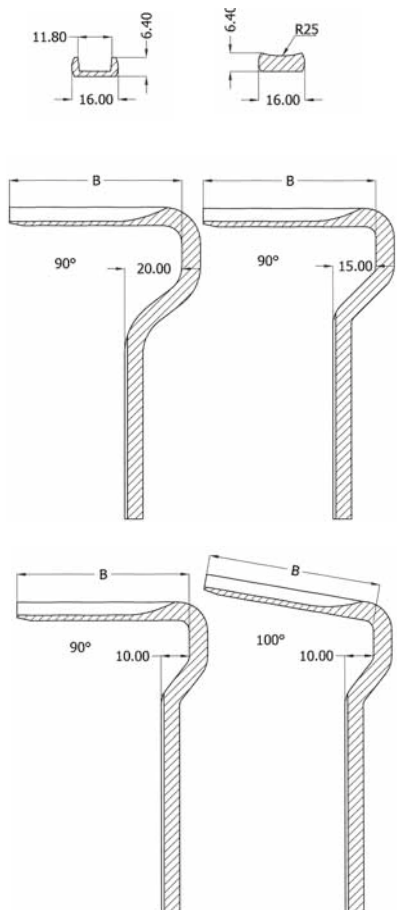

Angled blade plates for intertrochanteric femoral osteotomies in Adolescents 90°

Winkelplatten für intertrochantäre Femurosteotomien für kleinwüchsige Erwachsene 90°

Plaques coudée pour ostéotomies intertrochantériennes du fémur chez adolescent 90°



Indication: This plate is principally used for intertrochanteric femoral osteotomies in small statured adults or in adolescent.

Plate details: These plates have angle of 90° between blade and shaft. Shaft with 3 and 4 dynamic compression holes or round holes. Length of blade measured on inner side.

Plate thickness: 5.0 mm

Plate width: 13.0 mm

Hole spacing: 16.0 mm

T-Profile blade: 5.0 mm - 11.5 mm

Screws to be used: Fixation with 4.5 mm cortical screws. Shaft with 3 and 4 DCP dynamic compression hole for round holes. Also slot available for tension device.

Material: Certified Stainless Steel according to ASTM F.138 - ISO 5832/1.

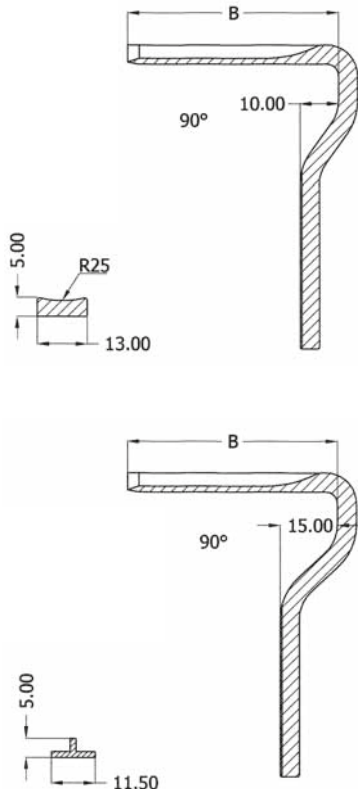

Hole Type		Holes	Length of blade mm	Displacement mm
DCP	Round			
90°				
ROT-305340-10 D	ROT-305340-10	3	40	10
ROT-305345-10 D	ROT-305345-10	3	45	10
ROT-305350-10 D	ROT-305350-10	3	50	10
ROT-305355-10 D	ROT-305355-10	3	55	10
ROT-305360-10 D	ROT-305360-10	3	60	10
ROT-305440-10 D	ROT-305440-10	4	40	10
ROT-305445-10 D	ROT-305445-10	4	45	10
ROT-305450-10 D	ROT-305450-10	4	50	10
ROT-305455-10 D	ROT-305455-10	4	55	10
ROT-305460-10 D	ROT-305460-10	4	60	10
ROT-305340-15 D	ROT-305340-15	3	40	15
ROT-305345-15 D	ROT-305345-15	3	45	15
ROT-305350-15 D	ROT-305350-15	3	50	15
ROT-305355-15 D	ROT-305355-15	3	55	15
ROT-305360-15 D	ROT-305360-15	3	60	15
ROT-305440-15 D	ROT-305440-15	4	40	15
ROT-305445-15 D	ROT-305445-15	4	45	15
ROT-305450-15 D	ROT-305450-15	4	50	15
ROT-305455-15 D	ROT-305455-15	4	55	15
ROT-305460-15 D	ROT-305460-15	4	60	15

Angled blade plates for intertrochanteric femoral osteotomies in children

Winkelplatten für intertrochantäre Femurosteotomien bei Kinder

Plaques coudée pour ostéotomies intertrochantériennes du fémur chez l'enfant

Indication: This plate is principally used for intertrochanteric femoral osteotomies in children up to 10 years of age.

Plate details: These plates have three different angle of 80°-90°-100° between blade and shaft. Shaft with 3 and 4 dynamic compression holes or round holes. Length of blade measured on inner side.

Plate thickness: 4.0 mm

Plate width: 11.5 mm

Hole spacing: 16.0 mm

T-Profile blade: 4.0 mm - 11.5 mm

Screws to be used: Fixation with 4.5 mm cortical screws. Shaft with 3 and 4 DCP dynamic compression hole for round holes. Also slot available for tension device.

Material: Certified Stainless Steel according to ASTM F.138 - ISO 5832/1.

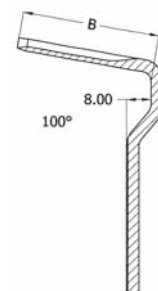
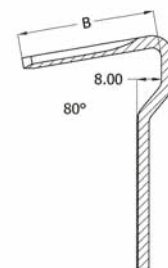
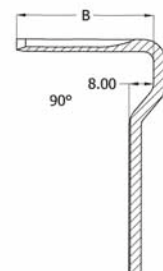
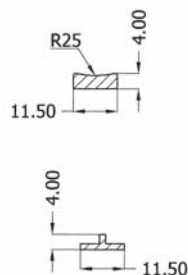

Hole Type	Holes	Length of blade mm	Displacement mm
DCP			
90°			
ROT-306335-98 D	3	35	8
ROT-306345-98 D	3	45	8
80°			
ROT-306335-88 D	3	35	8
ROT-306345-88 D	3	45	8
100°			
ROT-306335-08 D	3	35	8
ROT-306345-08 D	3	45	8

Angled blade plates for intertrochanteric femoral osteotomies in infant

Winkelplatten für intertrochantäre Femurosteotomien bei Kleinkinder

Plaques coudée pour ostéotomies intertrochantériennes du fémur chez le petite enfant



Indication: This plate is principally used for intertrochanteric femoral osteotomies in children up to 5 years of age.

Plate details: These plates have angle of 90° between blade and shaft. Shaft with 3 dynamic compression holes or round holes. Length of blade measured on inner side.

Plate thickness: 2.5 mm

Plate width: 10.5 mm

Hole spacing: 10.0 mm

T-Profile blade: 2.5 mm - 8.5 mm

Screws to be used: Fixation with 3.5 mm cortical screws. Shaft with 3 and 4 DCP dynamic compression hole for round holes. Also slot available for tension device.

Material: Certified Stainless Steel according to ASTM F.138 - ISO 5832/1.

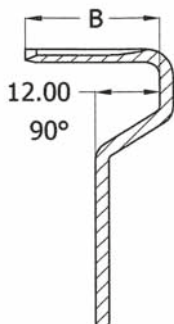
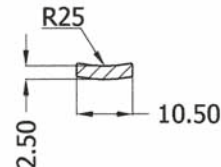
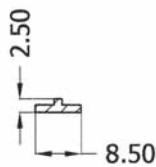
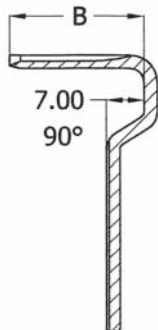

Hole Type	Holes	Length of blade mm	Displacement mm
DCP 90°			
ROT-307325-07 D	3	25	7
ROT-307332-07 D	3	32	7
ROT-307325-12 D	3	25	12
ROT-307332-12 D	3	32	12

DHS Plate

DHS Platte

Plaque de DHS

Indication: The compression hip plate is primarily indicated for intertrochanteric fractures. However, it can be also find applications in selected sub-trochanteric fractures, mid cervical and low sub-capital fractures of the femoral neck. A complete range of angled plate is available from 130° to 150° in 5° increments. They are used in conjunction with large diameter sliding lag screws. The lag screws have a coarse buttress thread to provide secure fixation in the femoral head. The shaft of the lag screw is machined on two opposing sides to correspond to the internal flats of the plate barrel preventing rotation of the lag. The barrel of the plate is available in two lengths, 38 mm for normal adult use

and 25 mm for smaller adult pediatric surgery (special request). If needed, added compression can be applied to the fractures site by means of the compression screws.

Plate details: Designed for maximum strength from one piece, forged.

Plate thickness: 5.6 mm

Plate width: 18.0 mm

Hole spacing: 16.0 mm

Screws to be used: All holes accept diam. 4.5 mm cortical screws. End of holes also accept diam. 6.5 mm cancellous screws. All plates are slotted to accept a tension device.

Material: Certified Stainless Steel according to ASTM F.138 - ISO 5832/1.



Ref. No Stainless Steel	Holes	Length mm
135°		
ROT-309135-04	4	82
ROT-309135-05	5	98
ROT-309135-06	6	114

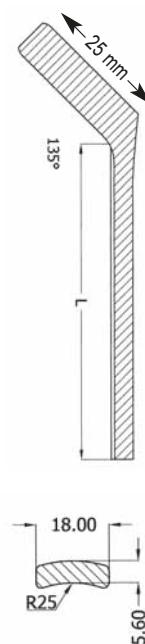

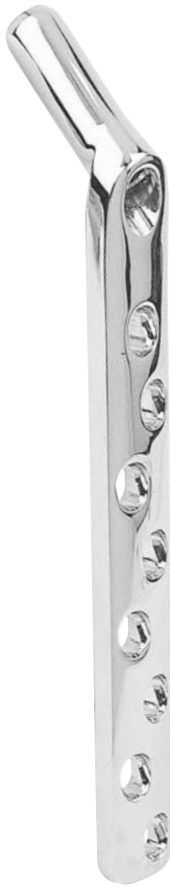

DHS Plate

DHS Platte

Plaque de DHS

Indication: The compression hip plate is primarily indicated for intertrochanteric fractures. However, it can be also find applications in selected sub-trochanteric fractures, mid cervical and low sub-capital fractures of the femoral neck. A complete range of angled plate is available from 130° to 150° in 5° increments. They are used in conjunction with large diameter sliding lag screws. The lag screws have a coarse buttress thread to provide secure fixation in the femoral head. The shaft of the lag screw is machined on two opposing sides to correspond to the internal flats of the plate barrel preventing rotation of the lag. The barrel of the plate is available in two lengths, 38 mm for normal adult use and 25 mm for smaller adult pediatric surgery (special request). If needed, added compression can be applied to the fractures site by means of the compression screws.

Plate details: Designed for maximum strenght from one piece, forged.

Plate thickness: 5.6 mm

Plate width: 18.0 mm

Hole spacing: 16.0 mm

Screws to be used: All holes accept diam. 4.5 mm cortical screws. End of holes also accept diam. 6.5 mm cancellous screws. All plates are slotted to accept a tension device.

Material: Certified Stainless Steel according to ASTM F.138 - ISO 5832/1.

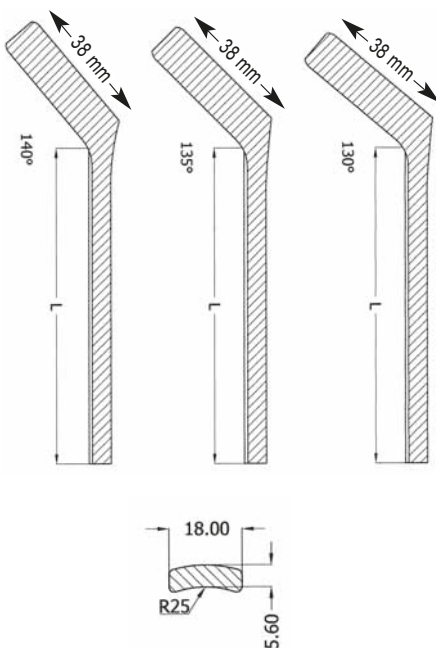

Ref. No	Holes	Length mm
Stainless Steel		
130°		
ROT-310130-02	2	50
ROT-310130-03	3	66
ROT-310130-04	4	82
ROT-310130-05	5	98
ROT-310130-06	6	114
135°		
ROT-310135-02	2	50
ROT-310135-03	3	66
ROT-310135-04	4	82
ROT-310135-05	5	98
ROT-310135-06	6	114
ROT-310135-08	8	146
ROT-310135-10	10	178
ROT-310135-12	12	210
ROT-310135-14	14	242
ROT-310135-16	16	274
ROT-310135-18	18	290
140°		
ROT-310140-02	2	50
ROT-310140-03	3	66
ROT-310140-04	4	82
ROT-310140-05	5	98
ROT-310140-06	6	114
ROT-310140-08	8	146
ROT-310140-10	10	178
ROT-310140-12	12	210
145°		
ROT-310145-02	2	50
ROT-310145-03	3	66
ROT-310145-04	4	82
ROT-310145-05	5	98
ROT-310145-06	6	114
ROT-310145-08	8	146
ROT-310145-10	10	178
ROT-310145-12	12	210
ROT-310145-14	14	242
150°		
ROT-310150-02	2	50
ROT-310150-03	3	66
ROT-310150-04	4	82
ROT-310150-05	5	98
ROT-310150-06	6	114
ROT-310150-08	8	146
ROT-310150-10	10	178
ROT-310150-12	12	210
ROT-310150-14	14	242

DCS Plate 95°

DCS Platte 95°

Plaques de DCS 95°

Indication: Condylar plate is indicated primarily for the fixation of supracondylar fractures and for intercondylar. T and Y fractures. There are certain occasions when a proximal femoral fractures may be treated with the sliding condylar screw, such as a complex proximal spiral fracture.

Plate thickness: 6.5 mm

Plate width: 16.0 mm

Hole spacing: 16.0 mm

Screws to be used: All holes accept diam. 4.5 mm cortical screws. End of holes also accept diam. 6.5 mm cancellous screws. All plates are slotted to accept a tension device.

Plate details: Designed for maximum strength from one piece, forged.

Material: Certified Stainless Steel according to ASTM F.138 - ISO 5832/1.



Ref. No	Holes	Length mm
Stainless Steel		
ROT-311114-06	6	114
ROT-311146-08	8	146
ROT-311178-10	10	178
ROT-311210-12	12	210
ROT-311242-14	14	242
ROT-311274-16	16	274
ROT-311306-18	18	306
ROT-311338-20	20	338
ROT-311370-22	22	370

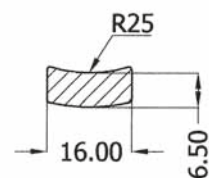
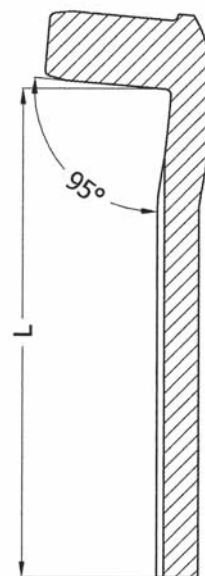

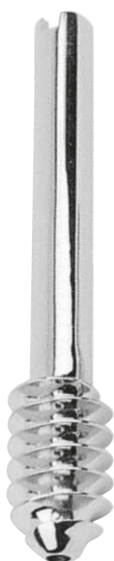

DHS/DCS Lag Screw

Indication: To be used in case of intracapsular and intercervical fractures, and some types of interchanteric fractures. Cannulated to receive the guide wires with a slot to make rotation impossible. Partially threaded heavy duty lag screw for use with DHS and DCS plates. Buttress thread from provides enhanced pull-out resistance in can-

cellous bone. Opposing flats along shark engage with machined flats within plate barrel to prevent rotation. Tapered tip permits easier insertion. Thread diameter 12.5 mm, thread length 22 mm.

Material: Certified Stainless Steel according to ASTM F.138 - ISO 5832/1.

Ref. No Stainless Steel	Ref. No Titanium	Length mm
ROT-312050	ROT-312050 T	50
ROT-312055	ROT-312055 T	55
ROT-312060	ROT-312060 T	60
ROT-312065	ROT-312065 T	65
ROT-312070	ROT-312070 T	70
ROT-312075	ROT-312075 T	75
ROT-312080	ROT-312080 T	80
ROT-312085	ROT-312085 T	85
ROT-312090	ROT-312090 T	90
ROT-312095	ROT-312095 T	95
ROT-312100	ROT-312100 T	100
ROT-312105	ROT-312105 T	105
ROT-312110	ROT-312110 T	110
ROT-312115	ROT-312115 T	115
ROT-312120	ROT-312120 T	120
ROT-312125	ROT-312125 T	125
ROT-312130	ROT-312130 T	130
ROT-312135	ROT-312135 T	135
ROT-312140		140
ROT-312145		145



DHS/DCS Compression Screw

Indication: Provides mechanical compression at the fracture site when used in conjunction with DHS and DCS compression lag screws. It is socket head screws.

Material: Certified Stainless Steel according to ASTM F.138 - ISO 5832/1.

Ref. No Stainless Steel	Ref. No Titanium	Length mm
ROT-312031	ROT-312031 T	31

Jewett Plate

Jewett Platte

Clous plaques de jewett

Indication: It may be used for the treatment of basicervical and pertrochanteric fractures of the proximal femur. These plates are forged for providing maximum strength at critical stress areas. Blade of plates are fully cannulated to accept guide pin. Screws holes are round and accept 4.5 mm cortical screws. Plate with 135° angle is standard. Other angles of 130°-140° are available on special request.

Plate details: Jewett plate have an angle of 135° between blade and shaft.

Plate width: 18.0 mm

Hole spacing: 19.0 mm

Screws to be used: All holes accept diam. 4.5 mm cortical screws.

Material: Designed for maximum strength from one piece forged. Certified Stainless Steel according to ASTM F.138 - ISO 5832/1.

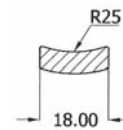
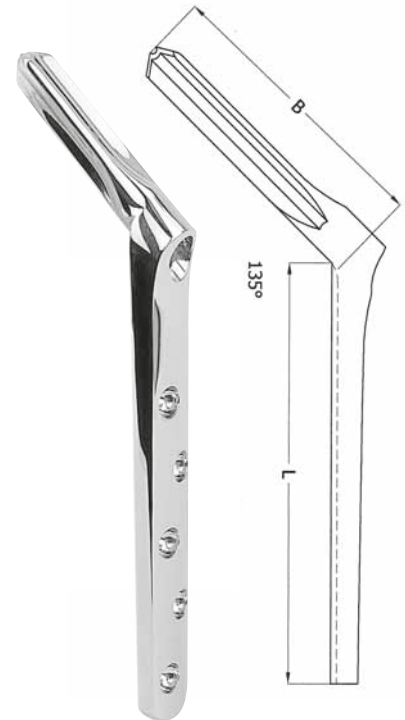

Description		Length of Blade (mm)												
Length of Shaft mm	Holes	Ref. No ROT-317...-...												
		50	55	60	65	70	75	80	85	90	95	100	105	110
110	4	050-04	055-04	060-04	065-04	070-04	075-04	080-04	085-04	090-04	095-04	100-04	105-04	110-04
125	5	050-05	055-05	060-05	065-05	070-05	075-05	080-05	085-05	090-05	095-05	100-05	105-05	110-05
145	6	050-06	055-06	060-06	065-06	070-06	075-06	080-06	085-06	090-06	095-06	100-06	105-06	110-06
165	7	050-07	055-07	060-07	065-07	070-07	075-07	080-07	085-07	090-07	095-07	100-07	105-07	110-07
185	8	050-08	055-08	060-08	065-08	070-08	075-08	080-08	085-08	090-08	095-08	100-08	105-08	110-08
205	9	050-09	055-09	060-09	065-09	070-09	075-09	080-09	085-09	090-09	095-09	100-09	105-09	110-09
225	10	050-10	055-10	060-10	065-10	070-10	075-10	080-10	085-10	090-10	095-10	100-10	105-10	110-10
245	11	050-11	055-11	060-11	065-11	070-11	075-11	080-11	085-11	090-11	095-11	100-11	105-11	110-11
265	12	050-12	055-12	060-12	065-12	070-12	075-12	080-12	085-12	090-12	095-12	100-12	105-12	110-12
285	13	050-13	055-13	060-13	065-13	070-13	075-13	080-13	085-13	090-13	095-13	100-13	105-13	110-13
300	14	050-14	055-14	060-14	065-14	070-14	075-14	080-14	085-14	090-14	095-14	100-14	105-14	110-14
325	15	050-15	055-15	060-15	065-15	070-15	075-15	080-15	085-15	090-15	095-15	100-15	105-15	110-15
345	16	050-16	055-16	060-16	065-16	070-16	075-16	080-16	085-16	090-16	095-16	100-16	105-16	110-16



Femoral Interlocking nail

Femur Verriegelungsnägel

Clous centromedullaires pour femur

Indication: This interlocking nail system is the result of long term experience in medullary nailing. This nail can be used for the following fractures;

- Femoral shaft fractures
- Subtrochanteric fractures
- Impending pathologic fractures
- Ipsilateral femoral neck / shaft fractures
- For femoral shaft fractures or stable subtrochanteric fractures, 135° antegrade fixation for the left-side / right-side femur. Locking bolts screw diameter is proximally and distally the same. In pertrochanteric (femoral neck) fractures as well as

subtrochanteric fractures, this femoral nail system (nails for the left and right femur with 8° anteversion integrated in proximal nail drill holes) offer a secure fixation. This nail system can also be applied in the case of dangerous pathologic fractures. Fixation is achieved with lag screws placed into femoral neck in retrograde direction, as a result rotation is avoided.

Material: Certified Stainless Steel according to ASTM F.138 - ISO 5832/1.

Length mm	Ref. No ROT-401...-..								
	Diameters								
	8	9	10	11	12	13	14	15	16
240	240-08	240-09	240-10						
260	260-08	260-09	260-10						
280	280-08	280-09	280-10						
300	300-08	300-09	300-10						
320	320-08	320-09	320-10	320-11	320-12				
340	340-08	340-09	340-10	340-11	340-12				
360	360-08	360-09	360-10	360-11	360-12	360-13	360-14		
380	380-08	380-09	380-10	380-11	380-12	380-13	380-14	380-15	380-16
400		400-09	400-10	400-11	400-12	400-13	400-14	400-15	400-16
420		420-09	420-10	420-11	420-12	420-13	420-14	420-15	420-16
440		440-09	440-10	440-11	440-12	440-13	440-14	440-15	440-16
460			460-10	460-11	460-12	460-13	460-14	460-15	460-16

Femoral Locking Screws for

Proximal

Distal



Ø 5.0

Length mm	Diameters 5.0 mm	
	Locking Screws for Proximal Holes	Cannulated Locking Screws for Distal Holes
25	ROT-402025-01	ROT-402025-02
30	ROT-402030-01	ROT-402030-02
35	ROT-402035-01	ROT-402035-02
40	ROT-402040-01	ROT-402040-02
45	ROT-402045-01	ROT-402045-02
50	ROT-402050-01	ROT-402050-02
55	ROT-402055-01	ROT-402055-02
60	ROT-402060-01	ROT-402060-02
65	ROT-402065-01	ROT-402065-02
70	ROT-402070-01	ROT-402070-02
75	ROT-402075-01	
80	ROT-402080-01	
85	ROT-402085-01	
90	ROT-402090-01	



Ø 5.0

Femoral Locking Screws for

Proximal

Distal



Ø 6.4

Length mm	Diameters 6.4 mm	
	Femoral Locking Screws	Cannulated Femoral Locking Screws
30	ROT-402030-10	ROT-402030-11
35	ROT-402035-10	ROT-402035-11
40	ROT-402040-10	ROT-402040-11
45	ROT-402045-10	ROT-402045-11
50	ROT-402050-10	ROT-402050-11
55	ROT-402055-10	ROT-402055-11
60	ROT-402060-10	ROT-402060-11
65	ROT-402065-10	ROT-402065-11
70	ROT-402070-10	ROT-402070-11
75	ROT-402075-10	ROT-402075-11
80	ROT-402080-10	ROT-402080-11
85	ROT-402085-10	
90	ROT-402090-10	



Ø 6.4

Locking End Cap

Ref. No
ROT-402000



Tibial Interlocking nail

Locking End Cap

Tibial Verriegelungsnägel

Clous centromedullaires pour tibia

Ref. No
ROT-402000



Indication: This interlocking nail system is the result of long term experience in medullary nailing. This nail can be used for open tibial shaft fractures and closed tibial shaft fractures. This tibial nail offer unbeatable versatility in the treatment specially for traumatic, pathologic, non-union and reconstructive surgery and makes possible treating of fractures within a range of 60% of the tibial length.

Material: Certified Stainless Steel according to ASTM F.138 - ISO 5832/1.

Length mm	Ref. No ROT-403...-..						
	Diameters						
	8	9	10	11	12	13	14
270	270-08	270-09	270-10				
285	285-08	285-09	285-10	285-11	285-12	285-13	
300	300-08	300-09	300-10	300-11	300-12	300-13	300-14
315	315-08	315-09	315-10	315-11	315-12	315-13	315-14
330	330-08	330-09	330-10	330-11	330-12	330-13	330-14
345	345-08	345-09	345-10	345-11	345-12	345-13	345-14
360	360-08	360-09	360-10	360-11	360-12	360-13	360-14
380	380-08	380-09	380-10	380-11	380-12	380-13	380-14
400	400-08	400-09	400-10	400-11	400-12	400-13	400-14
420	420-08	420-09	420-10	420-11	420-12	420-13	420-14
440		440-09	440-10	440-11	440-12	440-13	440-14



Ø 5.0



Ø 5.0



Ø 4.5

Length mm	Diameters 5.0 mm		Length mm	Diameters 4.5 mm
	Locking Screws for Proximal Holes	Canullated Locking Screws for Distal Holes		Locking Screws Self-tapping
25	ROT-402025-01	ROT-402025-02	32	ROT-108-032-S
30	ROT-402030-01	ROT-402030-02	36	ROT-108-036-S
35	ROT-402035-01	ROT-402035-02	40	ROT-108-040-S
40	ROT-402040-01	ROT-402040-02	44	ROT-108-044-S
45	ROT-402045-01	ROT-402045-02	48	ROT-108-048-S
50	ROT-402050-01	ROT-402050-02	52	ROT-108-052-S
55	ROT-402055-01	ROT-402055-02		
60	ROT-402060-01	ROT-402060-02		
65	ROT-402065-01	ROT-402065-02		
70	ROT-402070-01	ROT-402070-02		
75	ROT-402075-01			
80	ROT-402080-01			
85	ROT-402085-01			
90	ROT-402090-01			

Locking Screw



Ref. No	Diam (mm)	Length (mm)
Stainless Steel		
ROT-402035-01	5	35
ROT-402040-01	5	40
ROT-402045-01	5	45
ROT-402050-01	5	50
ROT-402055-01	5	55
ROT-402060-01	5	60
ROT-402065-01	5	65
ROT-402070-01	5	70

Intramedullary Nail Fixation Bolt



Ref. No	Size (Ø)
ROT-405011	11
ROT-405012	12
ROT-405013	13

Supra-condylar Intramedullary Nail



Ref. No	Diam (mm)	Length (mm)
Stainless Steel		
ROT-405150-11	11	150
ROT-405200-11	11	200
ROT-405250-11	11	250
ROT-405150-12	12	150
ROT-405200-12	12	200
ROT-405250-12	12	250
ROT-405150-13	13	150
ROT-405200-13	13	200
ROT-405250-13	13	250



Femur Küntscher intramedullary Nail double slot

Küntscher-Marknägel für Femur

Clous centromedullaires de Küntscher pour femur

Indication: Used for closed intra-medullary nailing of fractures and osteotomies of femur, radius and ulna, as well as for distally located fractures of the humerus with image intensification. Nails curved on a constant radius (slot on outside of curve). Conforms to the anterior bow of the femur.

Nails for closed nailing will be delivered slotted and tapered at one end.

Nail details: Küntscher medullary nails are produced with a cloverleaf

profile to achieve axial and longitudinal elasticity. The cloverleaf designed combines high tensile strength with compressibility to minimize the danger of splitting the femur, when the nail is being driven. In addition, this feature allows the nail to expand to fit the wider portions of the medullary canal.

Material: Certified Stainless Steel according to ASTM F.138 - ISO 5832/1.

Length mm	Ref. No ROT-406...--												
	Diameters												
	6	7	8	9	10	11	12	13	14	15	16	17	18
140	140-06	140-07											
160	160-06	160-07											
180	180-06	180-07											
200	200-06	200-07											
220	220-06	220-07											
240	240-06	240-07	240-08										
260	260-06	260-07	260-08										
280	280-06	280-07	280-08										
300	300-06	300-07	300-08	300-09									
320	320-06	320-07	320-08	320-09	320-10	320-11							
340	340-06	340-07	340-08	340-09	340-10	340-11	340-12	340-13	340-14				
360	360-06	360-07	360-08	360-09	360-10	360-11	360-12	360-13	360-14	360-15	360-16	360-17	360-18
380		380-07	380-08	380-09	380-10	380-11	380-12	380-13	380-14	380-15	380-16	380-17	380-18
400		400-07	400-08	400-09	400-10	400-11	400-12	400-13	400-14	400-15	400-16	400-17	400-18
420			420-08	420-09	420-10	420-11	420-12	420-13	420-14	420-15	420-16	420-17	420-18
440			440-08	440-09	440-10	440-11	440-12	440-13	440-14	440-15	440-16	440-17	440-18
460			460-08	460-09	460-10	460-11	460-12	460-13	460-14	460-15	460-16	460-17	460-18
480			480-08	480-09	480-10	480-11	480-12	480-13	480-14	480-15	480-16	480-17	480-18
500			500-08	500-09	500-10	500-11	500-12	500-13	500-14	500-15	500-16	500-17	500-18
520				520-09	520-10	520-11	520-12	520-13	520-14	520-15	520-16	520-17	520-18

Femur Küntscher intramedullary Nail single slot

Küntscher-Marknägel für Femur

Clous centromedullaires de Küntscher pour femur

Indication: Used for closed intra-medullary nailing of fractures and osteotomies of femur, radius and ulna, as well as for distally located fractures of the humerus with image intensification. Nails curved on a constant radius (slot on outside of curve). Conforms to the anterior bow of the femur.

Nails for closed nailing will be delivered slotted and tapered at one end.

Nail details: Küntscher medullary nails are produced with a cloverleaf

profile to achieve axial and longitudinal elasticity. The cloverleaf designed combines high tensile strength with compressibility to minimize the danger of splitting the femur, when the nail is being driven. In addition, this feature allows the nail to expand to fit the wider portions of the medullary canal.

Material: Certified Stainless Steel according to ASTM F.138 - ISO 5832/1.



Length mm	Ref. No ROT-407....-												
	Diameters												
	6	7	8	9	10	11	12	13	14	15	16	17	18
140	140-06	140-07											
160	160-06	160-07											
180	180-06	180-07											
200	200-06	200-07											
220	220-06	220-07											
240	240-06	240-07	240-08										
260	260-06	260-07	260-08										
280	280-06	280-07	280-08										
300	300-06	300-07	300-08	300-09									
320	320-06	320-07	320-08	320-09	320-10	320-11							
340	340-06	340-07	340-08	340-09	340-10	340-11	340-12	340-13	340-14				
360	360-06	360-07	360-08	360-09	360-10	360-11	360-12	360-13	360-14	360-15	360-16	360-17	360-18
380		380-07	380-08	380-09	380-10	380-11	380-12	380-13	380-14	380-15	380-16	380-17	380-18
400		400-07	400-08	400-09	400-10	400-11	400-12	400-13	400-14	400-15	400-16	400-17	400-18
420			420-08	420-09	420-10	420-11	420-12	420-13	420-14	420-15	420-16	420-17	420-18
440			440-08	440-09	440-10	440-11	440-12	440-13	440-14	440-15	440-16	440-17	440-18
460			460-08	460-09	460-10	460-11	460-12	460-13	460-14	460-15	460-16	460-17	460-18
480			480-08	480-09	480-10	480-11	480-12	480-13	480-14	480-15	480-16	480-17	480-18
500			500-08	500-09	500-10	500-11	500-12	500-13	500-14	500-15	500-16	500-17	500-18
520				520-09	520-10	520-11	520-12	520-13	520-14	520-15	520-16	520-17	520-18



Tibia Küntscher intramedullary Nail

Küntscher-Marknägel für Tibia

Clous centromedullaires de Küntscher pour tibia

Indication: Nails for conical forged ends for closed nailing of fractures and osteotomies of tibia and humerus. The flap prevents impacting the nail too deeply. The slot has been widened above the proximal bend to avoid jamming of the guide pin.

combines high tensile strength with compressibility to minimize the danger of splitting the tibia, when the nail is being driven. In addition, this feature allows the nail to expand to fit the wider portions of the medullary canal.

Nail details: Küntscher medullary nails are produced with a cloverleaf profile to achieve axial and longitudinal elasticity. The cloverleaf designed

Material: Certified Stainless Steel according to ASTM F.138 - ISO 5832/1.

Length mm	Ref. No ROT-408...-..								
	Diameters								
	6	7	8	9	10	11	12	13	14
180	180-06	180-07	180-08	180-09	180-10	180-11	180-12	180-13	
190	190-06	190-07	190-08	190-09	190-10	190-11	190-12	190-13	
200	200-06	200-07	200-08	200-09	200-10	200-11	200-12	200-13	
210	210-06	210-07	210-08	210-09	210-10	210-11	210-12	210-13	
220	220-06	220-07	220-08	220-09	220-10	220-11	220-12	220-13	
230	230-06	230-07	230-08	230-09	230-10	230-11	230-12	230-13	
240	240-06	240-07	240-08	240-09	240-10	240-11	240-12	240-13	
250	250-06	250-07	250-08	250-09	250-10	250-11	250-12	250-13	
260	260-06	260-07	260-08	260-09	260-10	260-11	260-12	260-13	
270	270-06	270-07	270-08	270-09	270-10	270-11	270-12	270-13	
280	280-06	280-07	280-08	280-09	280-10	280-11	280-12	280-13	
290	290-06	290-07	290-08	290-09	290-10	290-11	290-12	290-13	
300	300-06	300-07	300-08	300-09	300-10	300-11	300-12	300-13	300-14
310		310-07	310-08	310-09	310-10	310-11	310-12	310-13	310-14
320		320-07	320-08	320-09	320-10	320-11	320-12	320-13	320-14
330		330-07	330-08	330-09	330-10	330-11	330-12	330-13	330-14
340		340-07	340-08	340-09	340-10	340-11	340-12	340-13	340-14
350		350-07	350-08	350-09	350-10	350-11	350-12	350-13	350-14
360		360-07	360-08	360-09	360-10	360-11	360-12	360-13	360-14
370		370-07	370-08	370-09	370-10	370-11	370-12	370-13	370-14
380		380-07	380-08	380-09	380-10	380-11	380-12	380-13	380-14
390		390-07	390-08	390-09	390-10	390-11	390-12	390-13	390-14
400		400-07	400-08	400-09	400-10	400-11	400-12	400-13	400-14

Ender Type Flexible Femoral intramedullary Nail

Ender Typen Flexible Markraumnägel für Femur

Clous centromedullaires flexibles type Ender pour femur

Indication: May be used for intramedullary fixation of pertrochanteric, intertrochanteric and subtrochanteric fractures of femur and tibia. May also be indicated for certain types of femoral diaphysis fractures where adequate fixation may be obtained.

Pin details: Cold worked to attain optimum temper. Diameter of femoral nail is 4.5 mm.

Material: Certified Stainless Steel according to ASTM F.138 - ISO 5832/1.

Ref. No	Diam	Length cm
ROT-410045-28	4.5	28
ROT-410045-29	4.5	29
ROT-410045-30	4.5	30
ROT-410045-31	4.5	31
ROT-410045-32	4.5	32
ROT-410045-33	4.5	33
ROT-410045-34	4.5	34
ROT-410045-35	4.5	35
ROT-410045-36	4.5	36
ROT-410045-37	4.5	37
ROT-410045-38	4.5	38
ROT-410045-39	4.5	39
ROT-410045-40	4.5	40
ROT-410045-41	4.5	41
ROT-410045-42	4.5	42
ROT-410045-43	4.5	43
ROT-410045-44	4.5	44
ROT-410045-45	4.5	45
ROT-410045-46	4.5	46
ROT-410045-47	4.5	47
ROT-410045-48	4.5	48





Ender Type Flexible Tibial intramedullary Nail

Ender Typen Flexible Markraumnägel für Tibia

Clous centromedullaires flexibles type Ender pour tibia

Indication: May be used for intramedullary fixation of the tibial fracture. May also be indicated for certain types of humeral fractures where adequate fixation may be obtained.

Pin details: Cold worked to attain optimum temper. Diameter of femoral nail is 3.5 mm.

Material: Certified Stainless Steel according to ASTM F.138 - ISO 5832/1.

Ref. No Stainless Steel	Diam	Length cm
ROT-411035-20	3.5	20
ROT-411035-22	3.5	22
ROT-411035-23	3.5	23
ROT-411035-24	3.5	24
ROT-411035-25	3.5	25
ROT-411035-26	3.5	26
ROT-411035-27	3.5	27
ROT-411035-28	3.5	28
ROT-411035-29	3.5	29
ROT-411035-30	3.5	30
ROT-411035-31	3.5	31
ROT-411035-32	3.5	32
ROT-411035-33	3.5	33
ROT-411035-34	3.5	34
ROT-411035-35	3.5	35
ROT-411035-36	3.5	36
ROT-411035-37	3.5	37
ROT-411035-38	3.5	38
ROT-411035-39	3.5	39
ROT-411035-40	3.5	40
ROT-411035-41	3.5	41
ROT-411035-42	3.5	42

Rush type intramedullary pin

Hakenförmige Rush-Marknägel

Clous de Rush

Indication: May be used for intramedullary fixation of shaft fractures of the diaphysis of long bones. The Rush intramedullary pin achieves the stabilisation of fractures through the opposition of dynamic forces. Points of pressure accurately transfix the fractured bone. The sled runner point enables the surgeon to insert from the side of the bone without driving it

through the opposing cortex. The hook helps guard against sliding into medullary canal.

Pin details: Cold worked to attain optimum temper.

Material: Certified Stainless Steel according to ASTM F.138 - ISO 5832/1.



Length mm	Ref. No ROT-413...-..			
	Diameters			
	2,4	3,2	4,8	6,4
25	025-24			
30	030-24			
40	040-24			
45	045-24			
50	050-24			
60	060-24			
65	065-24			
70	070-24			
75	075-24			
85	085-24			
90	090-24			
95	095-24			
100	100-24	100-32		
115	115-24	115-32		
125	125-24	125-32		
140	140-24	140-32		
150	150-24	150-32		
165	165-24	165-32		
180	180-24	180-32		
190	190-24	190-32		
205	205-24	205-32	205-48	
215	215-24	215-32		
220			220-48	
230	230-24	230-32		
235		235-32		
240	240-24	240-32	240-48	
255	255-24	255-32	255-48	
280			280-48	280-64
295			295-48	295-64
315			315-48	315-64
335			335-48	335-64
355			355-48	355-64
375				375-64
395				395-64
410				410-64
430				430-64

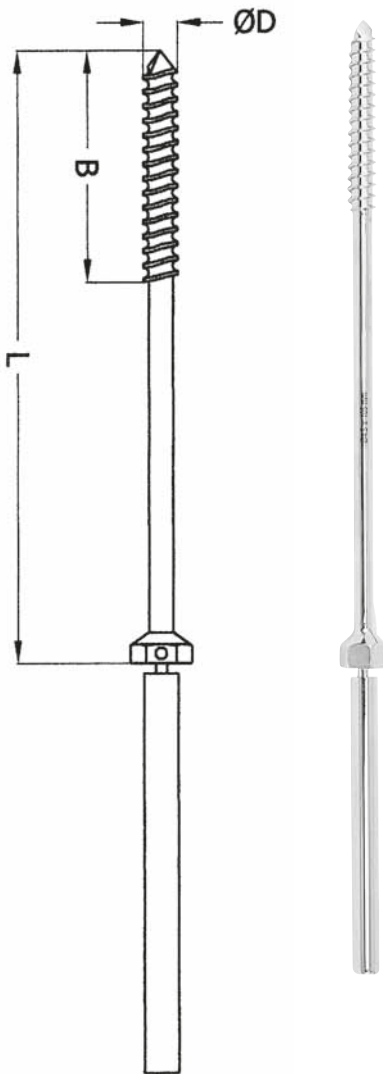

Knowless Hip pin

Knowless-Marknägel

Clous de Knowless

Indication: In order to ensure a good grip on the femoral head, the pins have been manufactured with deep coarse thread that is larger in than the smooth shaft. Provided with a square bead for easier removal. Shaft is undercut in the back of bead to provide a “snap-off” feature. All pins diameter are supplied from 50 mm to 140 mm overall which provides a longer pin shaft, keeping the chuck out of the surgical incision. Thread length standard 32 mm for all pins.

Pin details: Cold worked to attain optimum temper.

Material: Certified Stainless Steel according to ASTM F.138 - ISO 5832/1.

(B) mm	Length mm	Ref. No ROT-414...-...		
		Diameters		
		4.0	4.5	5.0
32	50	050-40	050-45	050-50
32	55	055-40	055-45	055-50
32	60	060-40	060-45	060-50
32	65	065-40	065-45	065-50
32	70	070-40	070-45	070-50
32	75	075-40	075-45	075-50
32	80	080-40	080-45	080-50
32	85	085-40	085-45	085-50
32	90	090-40	090-45	090-50
32	95	095-40	095-45	095-50
32	100	100-40	100-45	100-50
32	105	105-40	105-45	105-50
32	110	110-40	110-45	110-50
32	115	115-40	115-45	115-50
32	120	120-40	120-45	120-50
32	125	125-40	125-45	125-50
32	130	130-40	130-45	130-50
32	135	135-40	135-45	135-50
32	140	140-40	140-45	140-50

Schanz Screws

Schanz'sche Schrauben

Vis de Schanz

Indication: Fracture fixation. May also be used with REDA Circular external device and Tipofix Dynamic Axial fixators. Schanz are supplied with trocar point and three-sided end fits the Universal chuck.

Material: Certified Stainless Steel according to ASTM F.138 - ISO 5832/1.

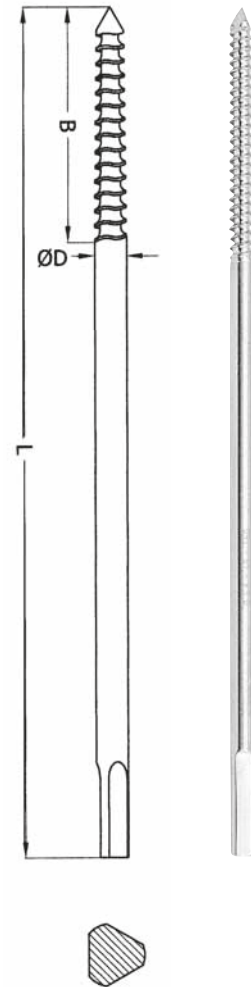

Ref. No Stainless Steel	Diam	Thread Length mm	Length mm
ROT-415150-30	3.0	30	150
ROT-415130-35	3.5	30	130
ROT-415150-35	3.5	35	150
ROT-415180-35	3.5	35	180
ROT-415130-40	4.0	30	130
ROT-415150-40	4.0	35	150
ROT-415180-40	4.0	40	180
ROT-415130-45	4.5	35	130
ROT-415150-45	4.5	45	150
ROT-415180-45	4.5	45	180
ROT-415130-50	5.0	35	130
ROT-415150-50	5.0	45	150
ROT-415180-50	5.0	45	180
ROT-415200-50	5.0	45	200
ROT-415220-50	5.0	45	220

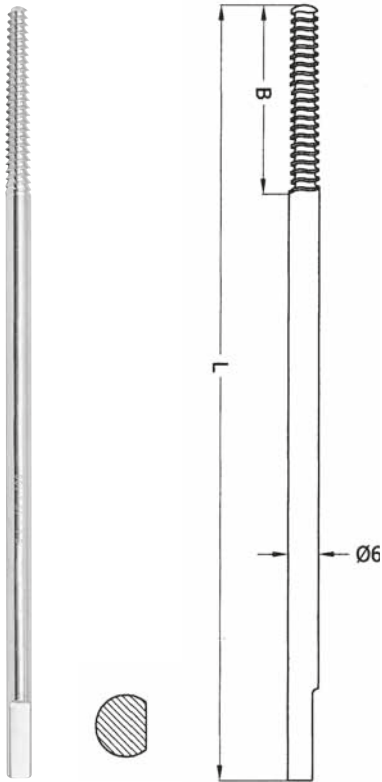

Schanz Screws with cortical thread

Schanz'sche Schrauben mit Kortikalisgewinde

Vis de Schanz à filetage cortical

Indication: Fracture fixation. May also be used specially with Tipofix Dynamic Axial fixators. These schanz screws are supplied with three-sided end fits the Universal chuck.

Material: Certified Stainless Steel according to ASTM F.138 - ISO 5832/1

Ref. No Stainless Steel	Diam	Thread Length mm	Length mm
ROT-416130-60	6.0	30	130
ROT-416150-60	6.0	45	150
ROT-416180-60	6.0	45	180
ROT-416200-60	6.0	45	200
ROT-416220-60	6.0	55	220

Section of Schanz intramedullary screws system with cancellous thread

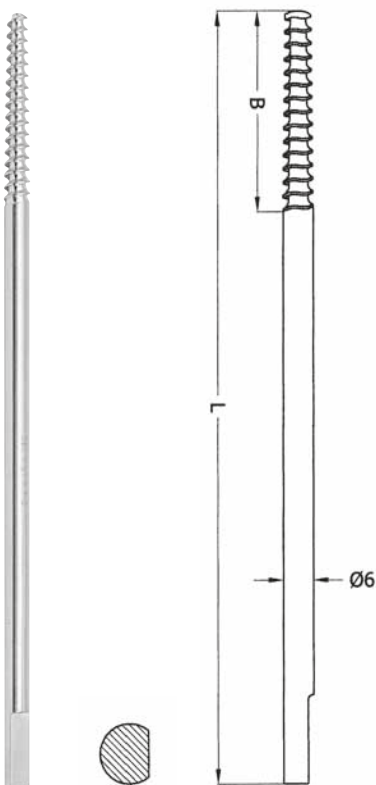

Schanz Screws with cancellous thread

Schanz'sche Schrauben mit Spongiosagewinde

Vis de Schanz à filetage spongieux

Indication: Fracture fixation. May also be used specially with Tipofix Dynamic Axial fixators. These schanz screws are supplied with three-sided end fits the Universal chuck.

Material: Certified Stainless Steel according to ASTM F.138 - ISO 5832/1

Ref. No Stainless Steel	Diam	Thread Length mm	Length mm
ROT-416130-60 C	6.0	30	130
ROT-416150-60 C	6.0	45	150
ROT-416180-60 C	6.0	45	180
ROT-416200-60 C	6.0	45	200
ROT-416220-60 C	6.0	55	220
ROT-416250-60 C	6.0	70	250

Steinmann Pins with Trocar point / round shaft end

Steinmann Nägel mit Trokarspitze / rundes Schaftende

Clavos para huesos Steinmann con Punta Trocar con extremo redondo

Chiodi per ossa Steinmann con Punta trequarti con estremità rotonda

Indication: Used in skeletal traction for alignment and reduction of fractures and with certain external fixation system. Steinman pins are supplied with trocar point.
Material: Certified Stainless Steel according to ASTM F.138 - ISO 5832/1.



Length mm	Ref. No ROT-417...-..					
	Diameters					
	3,2	3,5	4,0	4,5	5,0	6,0
80	080-32	080-35	080-40	080-45	080-50	080-60
100	100-32	100-35	100-40	100-45	100-50	100-60
120	120-32	120-35	120-40	120-45	120-50	120-60
140	140-32	140-35	140-40	140-45	140-50	140-60
150	150-32	150-35	150-40	150-45	150-50	150-60
160	160-32	160-35	160-40	160-45	160-50	160-60
180	180-32	180-35	180-40	180-45	180-50	180-60
200	200-32	200-35	200-40	200-45	200-50	200-60
210	210-32	210-35	210-40	210-45	210-50	210-60
220	220-32	220-35	220-40	220-45	220-50	220-60
240	240-32	240-35	240-40	240-45	240-50	240-60
250	250-32	250-35	250-40	250-45	250-50	250-60
260	260-32	260-35	260-40	260-45	260-50	260-60
280	280-32	280-35	280-40	280-45	280-50	280-60
300	300-32	300-35	300-40	300-45	300-50	300-60



Steinmann Pins with Trocar point / triangular shaft end

Steinmann Nägel mit Trokarspitze / 3-kant Schaftende

Clavos para huesos Steinmann con Punta Trocar con extremo triangular

Chiodi per ossa Steinmann con Punta trequarti con triangolari

Indication: Used in skeletal traction for alignment and reduction of fractures and with certain external fixation system. Steinman pins are supplied with trocar point. **Material:** Certified Stainless Steel according to ASTM F.138 - ISO 5832/1.



Length mm	Ref. No ROT-417...-.../3					
	Diameters					
	3,2	3,5	4,0	4,5	5,0	6,0
80	080-32/3	080-35/3	080-40/3	080-45/3	080-50/3	080-60/3
100	100-32/3	100-35/3	100-40/3	100-45/3	100-50/3	100-60/3
120	120-32/3	120-35/3	120-40/3	120-45/3	120-50/3	120-60/3
140	140-32/3	140-35/3	140-40/3	140-45/3	140-50/3	140-60/3
150	150-32/3	150-35/3	150-40/3	150-45/3	150-50/3	150-60/3
160	160-32/3	160-35/3	160-40/3	160-45/3	160-50/3	160-60/3
180	180-32/3	180-35/3	180-40/3	180-45/3	180-50/3	180-60/3
200	200-32/3	200-35/3	200-40/3	200-45/3	200-50/3	200-60/3
210	210-32/3	210-35/3	210-40/3	210-45/3	210-50/3	210-60/3
220	220-32/3	220-35/3	220-40/3	220-45/3	220-50/3	220-60/3
240	240-32/3	240-35/3	240-40/3	240-45/3	240-50/3	240-60/3
250	250-32/3	250-35/3	250-40/3	250-45/3	250-50/3	250-60/3
260	260-32/3	260-35/3	260-40/3	260-45/3	260-50/3	260-60/3
280	280-32/3	280-35/3	280-40/3	280-45/3	280-50/3	280-60/3
300	300-32/3	300-35/3	300-40/3	300-45/3	300-50/3	300-60/3

Steinmann Pins with Trocar point / Square headed shaft end

Steinmann Nägel mit Trokarspitze / 4-kant Schaftende

Clavos para huesos Steinmann con Punta Trocar con extremo cuadrangular

Chiodi per ossa Steinmann con Punta trequarti con quadrangolare

Indication: Used in skeletal traction for alignment and reduction of fractures and with certain external fixation system. Steinman pins are supplied with trocar point.
Material: Certified Stainless Steel according to ASTM F.138 - ISO 5832/1.

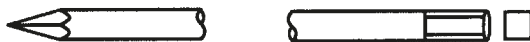

Length mm	Ref. No ROT-417...-../4					
	Diameters					
	3,2	3,5	4,0	4,5	5,0	6,0
80	080-32/4	080-35/4	080-40/4	080-45/4	080-50/4	080-60/4
100	100-32/4	100-35/4	100-40/4	100-45/4	100-50/4	100-60/4
120	120-32/4	120-35/4	120-40/4	120-45/4	120-50/4	120-60/4
140	140-32/4	140-35/4	140-40/4	140-45/4	140-50/4	140-60/4
150	150-32/4	150-35/4	150-40/4	150-45/4	150-50/4	150-60/4
160	160-32/4	160-35/4	160-40/4	160-45/4	160-50/4	160-60/4
180	180-32/4	180-35/4	180-40/4	180-45/4	180-50/4	180-60/4
200	200-32/4	200-35/4	200-40/4	200-45/4	200-50/4	200-60/4
210	210-32/4	210-35/4	210-40/4	210-45/4	210-50/4	210-60/4
220	220-32/4	220-35/4	220-40/4	220-45/4	220-50/4	220-60/4
240	240-32/4	240-35/4	240-40/4	240-45/4	240-50/4	240-60/4
250	250-32/4	250-35/4	250-40/4	250-45/4	250-50/4	250-60/4
260	260-32/4	260-35/4	260-40/4	260-45/4	260-50/4	260-60/4
280	280-32/4	280-35/4	280-40/4	280-45/4	280-50/4	280-60/4
300	300-32/4	300-35/4	300-40/4	300-45/4	300-50/4	300-60/4



Steinmann Pins with Trocar point / flat shaft end

Steinmann Nägel mit Trokarspitze / flaches Schaftende

Clavos para huesos Steinmann con Punta Trocar con extremo plano

Chiodi per ossa Steinmann con Punta trequarti con estremo piatto

Indication: Used in skeletal traction for alignment and reduction of fractures and with certain external fixation system. Steinman pins are supplied with trocar point. **Material:** Certified Stainless Steel according to ASTM F.138 - ISO 5832/1.



Length mm	Ref. No ROT-417...-.../F					
	Diameters					
	3,2	3,5	4,0	4,5	5,0	6,0
80	080-32/F	080-35/F	080-40/F	080-45/F	080-50/F	080-60/F
100	100-32/F	100-35/F	100-40/F	100-45/F	100-50/F	100-60/F
120	120-32/F	120-35/F	120-40/F	120-45/F	120-50/F	120-60/F
140	140-32/F	140-35/F	140-40/F	140-45/F	140-50/F	140-60/F
150	150-32/F	150-35/F	150-40/F	150-45/F	150-50/F	150-60/F
160	160-32/F	160-35/F	160-40/F	160-45/F	160-50/F	160-60/F
180	180-32/F	180-35/F	180-40/F	180-45/F	180-50/F	180-60/F
200	200-32/F	200-35/F	200-40/F	200-45/F	200-50/F	200-60/F
210	210-32/F	210-35/F	210-40/F	210-45/F	210-50/F	210-60/F
220	220-32/F	220-35/F	220-40/F	220-45/F	220-50/F	220-60/F
240	240-32/F	240-35/F	240-40/F	240-45/F	240-50/F	240-60/F
250	250-32/F	250-35/F	250-40/F	250-45/F	250-50/F	250-60/F
260	260-32/F	260-35/F	260-40/F	260-45/F	260-50/F	260-60/F
280	280-32/F	280-35/F	280-40/F	280-45/F	280-50/F	280-60/F
300	300-32/F	300-35/F	300-40/F	300-45/F	300-50/F	300-60/F

Steinmann Pins with Trocar point / trocar shaft end

Steinmann Nägel mit Trokarspitze / Trokar Schaftende

Clavos para huesos Steinmann con Punta Trocar con punta trocar

Chiodi per ossa Steinmann con Punta trequarti con trequarti Bilateral

Indication: Used in skeletal traction for alignment and reduction of fractures and with certain external fixation system. Steinman pins are supplied with trocar point.
Material: Certified Stainless Steel according to ASTM F.138 - ISO 5832/1.



Length mm	Ref. No ROT-417...-../T					
	Diameters					
	3,2	3,5	4,0	4,5	5,0	6,0
80	080-32/T	080-35/T	080-40/T	080-45/T	080-50/T	080-60/T
100	100-32/T	100-35/T	100-40/T	100-45/T	100-50/T	100-60/T
120	120-32/T	120-35/T	120-40/T	120-45/T	120-50/T	120-60/T
140	140-32/T	140-35/T	140-40/T	140-45/T	140-50/T	140-60/T
150	150-32/T	150-35/T	150-40/T	150-45/T	150-50/T	150-60/T
160	160-32/T	160-35/T	160-40/T	160-45/T	160-50/T	160-60/T
180	180-32/T	180-35/T	180-40/T	180-45/T	180-50/T	180-60/T
200	200-32/T	200-35/T	200-40/T	200-45/T	200-50/T	200-60/T
210	210-32/T	210-35/T	210-40/T	210-45/T	210-50/T	210-60/T
220	220-32/T	220-35/T	220-40/T	220-45/T	220-50/T	220-60/T
240	240-32/T	240-35/T	240-40/T	240-45/T	240-50/T	240-60/T
250	250-32/T	250-35/T	250-40/T	250-45/T	250-50/T	250-60/T
260	260-32/T	260-35/T	260-40/T	260-45/T	260-50/T	260-60/T
280	280-32/T	280-35/T	280-40/T	280-45/T	280-50/T	280-60/T
300	300-32/T	300-35/T	300-40/T	300-45/T	300-50/T	300-60/T



Steinmann pin, trocar point with 15 mm thread / round shaft end

Steinmann Nagel, Trokarspitze mit 15 mm Gewinde / rundes Schaftende

Steinmann clavo, punta trocar con 15 mm rosca / con extremo redondo

Steinmann chiodo, punta trocar con 15 mm filetto / con estremita rotonda

Indication: Used in skeletal traction for alignment and reduction of fractures and with certain external fixation system. Steinman pins are supplied with trocar point. **Material:** Certified Stainless Steel according to ASTM F.138 - ISO 5832/1.



Ref. No ROT-419...-..

Length mm	Diameters								
	2,0	2,4	2,5	2,8	3,2	3,5	4,0	4,5	5,0
230	230-20	230-24	230-25	230-28	230-32	230-35	230-40	230-45	230-50
300	300-20	300-24	300-25	300-28	300-32	300-35	300-40	300-45	300-50

Steinmann pin, trocar point with 15 mm thread / trocar shaft end with thread

Steinmann Nagel, Trokarspitze mit 15 mm Gewinde / Trokarende mit Gewinde

Steinmann clavo, punta trocar con 15 mm rosca / punta trocar con 15 mm rosca

Steinmann chiodo, punta trocar con 15 mm filetto / punta trocar con 15 mm filetto

Indication: Used in skeletal traction for alignment and reduction of fractures and with certain external fixation system. Steinman pins are supplied with trocar point.
Material: Certified Stainless Steel according to ASTM F.138 - ISO 5832/1.



Length mm	Ref. No ROT-419...-../T								
	Diameters								
	2,0	2,4	2,5	2,8	3,2	3,5	4,0	4,5	5,0
230	230-20/T	230-24/T	230-25/T	230-28/T	230-32/T	230-35/T	230-40/T	230-45/T	230-50/T
300	300-20/T	300-24/T	300-25/T	300-28/T	300-32/T	300-35/T	300-40/T	300-45/T	300-50/T



Steinmann pin, lance point with 15 mm thread / round shaft end

Steinmann Nagel, Lanzettenspitze mit 15 mm Gewinde / rundes Schaftende

Steinmann clavo, punta lanceolar con 15 mm rosca / con extremo redondo

Steinmann chiodo, punta lanceolata con 15 mm filetto / con estremita rotonda

Indication: Used in skeletal traction **Material:** Certified Stainless Steel for alignment and reduction of fractures according to ASTM F.138 - ISO 5832/1. and with certain external fixation system. Steinman pins are supplied with trocar point.



Ref. No ROT-421...-..

Length mm	Diameters								
	2,0	2,4	2,5	2,8	3,2	3,5	4,0	4,5	5,0
230	230-20	230-24	230-25	230-28	230-32	230-35	230-40	230-45	230-50
300	300-20	300-24	300-25	300-28	300-32	300-35	300-40	300-45	300-50

Steinmann pin, lance point with 15 mm thread / lance shaft end with thread

Steinmann Nagel, Lanzettenspitze mit 15 mm Gewinde / Lanzettenspitze mit Gewinde

Steinmann clavo, punta lanceolar con 15 mm rosca / punta lanceolar con 15 mm rosca

Steinmann chiodo, punta lanceolata con 15 mm filetto / punta lanceolata con 15 mm filetto

Indication: Used in skeletal traction for alignment and reduction of fractures and with certain external fixation system. Steinman pins are supplied with trocar point.
Material: Certified Stainless Steel according to ASTM F.138 - ISO 5832/1.



Length mm	Ref. No ROT-421...-../L								
	Diameters								
	2,0	2,4	2,5	2,8	3,2	3,5	4,0	4,5	5,0
230	230-20/L	230-24/L	230-25/L	230-28/L	230-32/L	230-35/L	230-40/L	230-45/L	230-50/L
300	300-20/L	300-24/L	300-25/L	300-28/L	300-32/L	300-35/L	300-40/L	300-45/L	300-50/L

Kirschner Drill wires with Trocar point / round shaft end

Kirschner Bohrdrähte mit Trokarspitze / rundes Schaftende

Alambres Kirschner Punta Trocar con extremo redondo

Perforatori filiformi Kirschner con Punta trequarti con estremità rotonda

Indication: Use in setting fractures. **Material:** Certified Stainless Steel
 Supplied with trocar point in which according to ASTM F.138 - ISO
 the tip is sharpened to a three facet 5832/1.
 point.



diam. mm	Ref. No ROT-440...-..					
	length					
	7	10	13	15	23	31
0,8	070-08	100-08	130-08	150-08	230-08	310-08
0,9		100-09	130-09	150-09	230-09	310-09
1,0	070-10	100-10	130-10	150-10	230-10	310-10
1,1		100-11	130-11	150-11	230-11	310-11
1,2		100-12	130-12	150-12	230-12	310-12
1,3		100-13	130-13	150-13	230-13	310-13
1,4		100-14	130-14	150-14	230-14	310-14
1,5		100-15	130-15	150-15	230-15	310-15
1,6		100-16	130-16	150-16	230-16	310-16
1,7		100-17	130-17	150-17	230-17	310-17
1,8		100-18	130-18	150-18	230-18	310-18
1,9		100-19	130-19	150-19	230-19	310-19
2,0		100-20	130-20	150-20	230-20	310-20
2,2		100-22	130-22	150-22	230-22	310-22
2,4		100-24	130-24	150-24	230-24	310-24
2,5	070-25	100-25	130-25	150-25	230-25	310-25
2,8		100-28	130-28	150-28	230-28	310-28
3,0		100-30	130-30	150-30	230-30	310-30

Kirschner Drill Wires with Trocar point / triangular shaft end

Kirschner Bohrdrähte mit Trokarspitze / 3-kant Schaftende

Alambres Kirschner con Punta Trocar con extremo triangular

Perforatori filiformi Kirschner con Punta trequarti con triangolari

Indication: Use in setting fractures. **Material:** Certified Stainless Steel
 Supplied with trocar point in which according to ASTM F.138 - ISO
 the tip is sharpened to a three facet 5832/1.
 point.



diam. mm	Ref. No ROT-440...-./3				
	length				
	10	13	15	23	31
2,0	100-20/3	130-20/3	150-20/3	230-20/3	310-20/3
2,2	100-22/3	130-22/3	150-22/3	230-22/3	310-22/3
2,4	100-24/3	130-24/3	150-24/3	230-24/3	310-24/3
2,5	100-25/3	130-25/3	150-25/3	230-25/3	310-25/3
2,8	100-28/3	130-28/3	150-28/3	230-28/3	310-28/3
3,0	100-30/3	130-30/3	150-30/3	230-30/3	310-30/3

Kirschner Drill Wires with Trocar point / Square headed shaft end

Kirschner Bohrdrähte mit Trokarspitze / 4-kant Schaftende

Alambres Kirschner con Punta Trocar con extremo cuadrangular

Perforatori filiformi Kirschner con Punta tre quarti con quadrangolare

Indication: Use in setting fractures. **Material:** Certified Stainless Steel
 Supplied with trocar point in which according to ASTM F.138 - ISO
 the tip is sharpened to a three facet 5832/1.
 point.



diam. mm	Ref. No ROT-440...-../4				
	length				
	10	13	15	23	31
2,0	100-20/4	130-20/4	150-20/4	230-20/4	310-20/4
2,2	100-22/4	130-22/4	150-22/4	230-22/4	310-22/4
2,4	100-24/4	130-24/4	150-24/4	230-24/4	310-24/4
2,5	100-25/4	130-25/4	150-25/4	230-25/4	310-25/4
2,8	100-28/4	130-28/4	150-28/4	230-28/4	310-28/4
3,0	100-30/4	130-30/4	150-30/4	230-30/4	310-30/4

Kirschner Drill Wires with Trocar point / flat shaft end

Kirschner Bohrdrähte mit Trokarspitze / flaches Schaftende

Alambres Kirschner con Punta Trocar con extremo plano

Perforatorio filiformi Kirschner con Punta trequarti con estremo piatto

Indication: Use in setting fractures. **Material:** Certified Stainless Steel
 Supplied with trocar point in which according to ASTM F.138 - ISO
 the tip is sharpened to a three facet 5832/1.
 point.



diam. mm	Ref. No ROT-440...-./F				
	length				
	10	13	15	23	31
0,8	100-08/F	130-08/F	150-08/F	230-08/F	310-08/F
0,9	100-09/F	130-09/F	150-09/F	230-09/F	310-09/F
1,0	100-10/F	130-10/F	150-10/F	230-10/F	310-10/F
1,1	100-11/F	130-11/F	150-11/F	230-11/F	310-11/F
1,2	100-12/F	130-12/F	150-12/F	230-12/F	310-12/F
1,3	100-13/F	130-13/F	150-13/F	230-13/F	310-13/F
1,4	100-14/F	130-14/F	150-14/F	230-14/F	310-14/F
1,5	100-15/F	130-15/F	150-15/F	230-15/F	310-15/F
1,6	100-16/F	130-16/F	150-16/F	230-16/F	310-16/F
1,7	100-17/F	130-17/F	150-17/F	230-17/F	310-17/F
1,8	100-18/F	130-18/F	150-18/F	230-18/F	310-18/F
1,9	100-19/F	130-19/F	150-19/F	230-19/F	310-19/F
2,0	100-20/F	130-20/F	150-20/F	230-20/F	310-20/F
2,2	100-22/F	130-22/F	150-22/F	230-22/F	310-22/F
2,4	100-24/F	130-24/F	150-24/F	230-24/F	310-24/F
2,5	100-25/F	130-25/F	150-25/F	230-25/F	310-25/F
2,8	100-28/F	130-28/F	150-28/F	230-28/F	310-28/F
3,0	100-30/F	130-30/F	150-30/F	230-30/F	310-30/F

Kirschner Drill Wires with Trocar point / trocar shaft end

Kirschner Bohrdrähte mit Trokarspitze / Trokar Schaftende

Alambres Kirschner con Punta Trocar con punta trocar

Chiodi per ossa Steinmann Punta trequarti con trequarti Bilateral

Indication: Use in setting fractures. **Material:** Certified Stainless Steel
Supplied with trocar point in which according to ASTM F.138 - ISO
the tip is sharpened to a three facet 5832/1.
point.



diam. mm	Ref. No ROT-440...-../T				
	length				
	10	13	15	23	31
0,8	100-08/T	130-08/T	150-08/T	230-08/T	310-08/T
0,9	100-09/T	130-09/T	150-09/T	230-09/T	310-09/T
1,0	100-10/T	130-10/T	150-10/T	230-10/T	310-10/T
1,1	100-11/T	130-11/T	150-11/T	230-11/T	310-11/T
1,2	100-12/T	130-12/T	150-12/T	230-12/T	310-12/T
1,3	100-13/T	130-13/T	150-13/T	230-13/T	310-13/T
1,4	100-14/T	130-14/T	150-14/T	230-14/T	310-14/T
1,5	100-15/T	130-15/T	150-15/T	230-15/T	310-15/T
1,6	100-16/T	130-16/T	150-16/T	230-16/T	310-16/T
1,7	100-17/T	130-17/T	150-17/T	230-17/T	310-17/T
1,8	100-18/T	130-18/T	150-18/T	230-18/T	310-18/T
1,9	100-19/T	130-19/T	150-19/T	230-19/T	310-19/T
2,0	100-20/T	130-20/T	150-20/T	230-20/T	310-20/T
2,2	100-22/T	130-22/T	150-22/T	230-22/T	310-22/T
2,4	100-24/T	130-24/T	150-24/T	230-24/T	310-24/T
2,5	100-25/T	130-25/T	150-25/T	230-25/T	310-25/T
2,8	100-28/T	130-28/T	150-28/T	230-28/T	310-28/T
3,0	100-30/T	130-30/T	150-30/T	230-30/T	310-30/T

Kirschner Drill wires with Lance point / round shaft end

Kirschner Bohrdrähte mit Lanzettenspitze / rundes Schaftende

Alambres Kirschner Punta lanceolar con extremo redondo

Perforatori filiformi Kirschner con Punta lanceolata con estremità rotonda

Indication: Use in setting fractures. **Material:** Certified Stainless Steel
 Supplied with trocar point in which according to ASTM F.138 - ISO
 the tip is sharpened to a three facet 5832/1.
 point.



diam. mm	Ref. No ROT-442...-..					
	length					
	7	10	13	15	23	31
0,8	070-08	100-08	130-08	150-08	230-08	310-08
0,9		100-09	130-09	150-09	230-09	310-09
1,0	070-10	100-10	130-10	150-10	230-10	310-10
1,1		100-11	130-11	150-11	230-11	310-11
1,2		100-12	130-12	150-12	230-12	310-12
1,3		100-13	130-13	150-13	230-13	310-13
1,4		100-14	130-14	150-14	230-14	310-14
1,5		100-15	130-15	150-15	230-15	310-15
1,6		100-16	130-16	150-16	230-16	310-16
1,7		100-17	130-17	150-17	230-17	310-17
1,8		100-18	130-18	150-18	230-18	310-18
1,9		100-19	130-19	150-19	230-19	310-19
2,0		100-20	130-20	150-20	230-20	310-20
2,2		100-22	130-22	150-22	230-22	310-22
2,4		100-24	130-24	150-24	230-24	310-24
2,5	070-25	100-25	130-25	150-25	230-25	310-25
2,8		100-28	130-28	150-28	230-28	310-28
3,0		100-30	130-30	150-30	230-30	310-30

Kirschner Drill Wires with lance point / triangular shaft end

Kirschner Bohrdrähte mit Lanzettenspitze / 3-kant Schaftende

Alambres Kirschner con Punta lanceolar con extremo triangular

Perforatori filiformi Kirschner con Punta lanceolata con triangolari

Indication: Use in setting fractures. **Material:** Certified Stainless Steel
 Supplied with trocar point in which according to ASTM F.138 - ISO
 the tip is sharpened to a three facet 5832/1.
 point.



diam. mm	Ref. No ROT-442...-../3				
	length				
	10	13	15	23	31
2,0	100-20/3	130-20/3	150-20/3	230-20/3	310-20/3
2,2	100-22/3	130-22/3	150-22/3	230-22/3	310-22/3
2,4	100-24/3	130-24/3	150-24/3	230-24/3	310-24/3
2,5	100-25/3	130-25/3	150-25/3	230-25/3	310-25/3
2,8	100-28/3	130-28/3	150-28/3	230-28/3	310-28/3
3,0	100-30/3	130-30/3	150-30/3	230-30/3	310-30/3

Kirschner Drill Wires with lance point / Square headed shaft end

Kirschner Bohrdrähte mit Lanzettenspitze / 4-kant Schaftende

Alambres Kirschner con Punta lanceolar con extremo cuadrangular

Perforatori filiformi Kirschner con Punta lanceolata con quadrangolare

Indication: Use in setting fractures. **Material:** Certified Stainless Steel
 Supplied with trocar point in which according to ASTM F.138 - ISO 5832/1. the tip is sharpened to a three facet point.



diam. mm	Ref. No ROT-442...-../4				
	length				
	10	13	15	23	31
2,0	100-20/4	130-20/4	150-20/4	230-20/4	310-20/4
2,2	100-22/4	130-22/4	150-22/4	230-22/4	310-22/4
2,4	100-24/4	130-24/4	150-24/4	230-24/4	310-24/4
2,5	100-25/4	130-25/4	150-25/4	230-25/4	310-25/4
2,8	100-28/4	130-28/4	150-28/4	230-28/4	310-28/4
3,0	100-30/4	130-30/4	150-30/4	230-30/4	310-30/4

Kirschner Drill Wires with lance point / flat shaft end

Kirschner Bohrdrähte mit Lanzettenspitze / flachem Schaftende

Alambres Kirschner con Punta lanceolar con extremo plano

Perforatore filiformi Kirschner con Punta lanceolata con estremo piatto

Indication: Use in setting fractures. **Material:** Certified Stainless Steel
 Supplied with trocar point in which according to ASTM F.138 - ISO
 the tip is sharpened to a three facet 5832/1.
 point.



diam. mm	Ref. No ROT-442...-./F				
	length				
	10	13	15	23	31
0,8	100-08/F	130-08/F	150-08/F	230-08/F	310-08/F
0,9	100-09/F	130-09/F	150-09/F	230-09/F	310-09/F
1,0	100-10/F	130-10/F	150-10/F	230-10/F	310-10/F
1,1	100-11/F	130-11/F	150-11/F	230-11/F	310-11/F
1,2	100-12/F	130-12/F	150-12/F	230-12/F	310-12/F
1,3	100-13/F	130-13/F	150-13/F	230-13/F	310-13/F
1,4	100-14/F	130-14/F	150-14/F	230-14/F	310-14/F
1,5	100-15/F	130-15/F	150-15/F	230-15/F	310-15/F
1,6	100-16/F	130-16/F	150-16/F	230-16/F	310-16/F
1,7	100-17/F	130-17/F	150-17/F	230-17/F	310-17/F
1,8	100-18/F	130-18/F	150-18/F	230-18/F	310-18/F
1,9	100-19/F	130-19/F	150-19/F	230-19/F	310-19/F
2,0	100-20/F	130-20/F	150-20/F	230-20/F	310-20/F
2,2	100-22/F	130-22/F	150-22/F	230-22/F	310-22/F
2,4	100-24/F	130-24/F	150-24/F	230-24/F	310-24/F
2,5	100-25/F	130-25/F	150-25/F	230-25/F	310-25/F
2,8	100-28/F	130-28/F	150-28/F	230-28/F	310-28/F
3,0	100-30/F	130-30/F	150-30/F	230-30/F	310-30/F

Kirschner Drill Wires with lance point / lance shaft end

Kirschner Bohrdrähte mit Lanzettenspitze / Lanzettenende

Alambres Kirschner con Punta lanceolar con punta lanceolar

Chiodi per ossa Kirschner Punta lanceolata con lanceolata Bilateral

Indication: Use in setting fractures. **Material:** Certified Stainless Steel
Supplied with trocar point in which according to ASTM F.138 - ISO
the tip is sharpened to a three facet 5832/1.
point.



diam. mm	Ref. No ROT-442...-../L				
	length				
	10	13	15	23	31
0,8	100-08/L	130-08/L	150-08/L	230-08/L	310-08/L
0,9	100-09/L	130-09/L	150-09/L	230-09/L	310-09/L
1,0	100-10/L	130-10/L	150-10/L	230-10/L	310-10/L
1,1	100-11/L	130-11/L	150-11/L	230-11/L	310-11/L
1,2	100-12/L	130-12/L	150-12/L	230-12/L	310-12/L
1,3	100-13/L	130-13/L	150-13/L	230-13/L	310-13/L
1,4	100-14/L	130-14/L	150-14/L	230-14/L	310-14/L
1,5	100-15/L	130-15/L	150-15/L	230-15/L	310-15/L
1,6	100-16/L	130-16/L	150-16/L	230-16/L	310-16/L
1,7	100-17/L	130-17/L	150-17/L	230-17/L	310-17/L
1,8	100-18/L	130-18/L	150-18/L	230-18/L	310-18/L
1,9	100-19/L	130-19/L	150-19/L	230-19/L	310-19/L
2,0	100-20/L	130-20/L	150-20/L	230-20/L	310-20/L
2,2	100-22/L	130-22/L	150-22/L	230-22/L	310-22/L
2,4	100-24/L	130-24/L	150-24/L	230-24/L	310-24/L
2,5	100-25/L	130-25/L	150-25/L	230-25/L	310-25/L
2,8	100-28/L	130-28/L	150-28/L	230-28/L	310-28/L
3,0	100-30/L	130-30/L	150-30/L	230-30/L	310-30/L

Tibia Bolt

Fixationsschrauben

Vis de fixation pour tibia

Indication: May be used for certain type fractures involving the proximal tibia. Supplied with trochar point. Bolt threaded from each end smooth in center so it will not displace fragments. Complete with two washer and hexagonal nuts. Available in two different diam. 3.0 mm and 4.0 mm

with ten different lengths starting from 60 to 150 mm with ten millimeter increments to enhance patient fit.

Material: Certified Stainless Steel according to ASTM F.138 - ISO 5832/1.



Ref. No Stainless Steel	Diam	Length mm
ROT-418060-30	3.0	60
ROT-418070-30	3.0	70
ROT-418080-30	3.0	80
ROT-418090-30	3.0	90
ROT-418100-30	3.0	100
ROT-418110-30	3.0	110
ROT-418120-30	3.0	120
ROT-418130-30	3.0	130
ROT-418140-30	3.0	140
ROT-418150-30	3.0	150
ROT-418060-40	4.0	60
ROT-418070-40	4.0	70
ROT-418080-40	4.0	80
ROT-418090-40	4.0	90
ROT-418100-40	4.0	100
ROT-418110-40	4.0	110
ROT-418120-40	4.0	120
ROT-418130-40	4.0	130
ROT-418140-40	4.0	140
ROT-418150-40	4.0	150

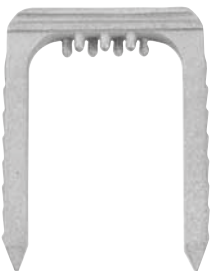

Thorny Staples

Fixationsklammern mit Dorne

Agrafes Ligamentaires crantees

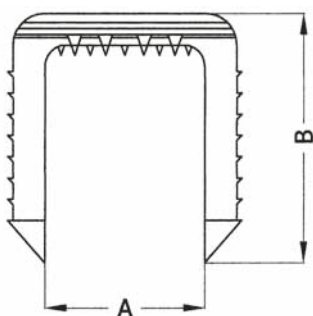

Indication: Staples are used in tendon and ligament fixation. Introduced through the interior of the guide with the staple screwed onto its end, proceeding with impaction of this staple at the desired point. Sharp spikes with a bevelled edge allow an easy insertion. This feature prevents any divergence of staple legs, even on convex cortical areas. These staples are fixed and stable in any direction, which guarantees the absence of spontaneous extraction and rigorous steadiness of the material, providing immediate stability to whole system and suppressing subsequent pain generally experienced due to micromovements of the material used. Removing these

staples remains easy owing to the firm grip of the staple driver.

Material: The Thorny staple is manufactured from casting Cr.Co-alloy according to ASTM F.75 - ISO 5832/4. This alloy characterized by demonstrating excellent biocompatibility together with a high resistance of corrosion and superiormechnical strength.

Ref. No Co.Cr	Lengths (mm)	
	A	B
ROT-422235-65	6.5	23.5
ROT-422235-80	8.0	23.5
ROT-422235-11	11.5	23.5
ROT-422235-15	15.0	23.5

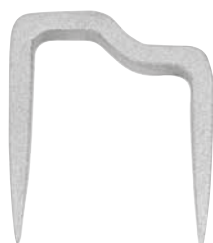

Asymetric Staples

Stufenklammern

Agrafes décalées

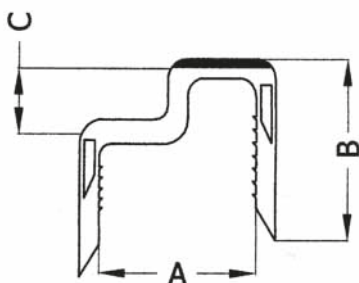

Indication: Osteosynthesis fixation staples for tibial or femoral osteotomy. Easy penetration, owing to the sharp spikes with a bevelled edge. No need for pilot holes being drilled. The 1.5 mm divergerce of the legs of the staples allow a progressive impact on both sides of the osteotomy. The anti-recoil contours are really efficient because they are set on the inner sides of the staple's legs precisely where pressure is applied. The fins increase the application surface of the forces on the cortical bone, which is often fragile, thus reducing the risk of subsequent loosening of the bond.

Material: The asymmetric staple is manufactured from casting Cr.Co-alloy according to ASTM F.75 - ISO 5832/4. This alloy characterized by demonstrating excellent biocompatibility together with a high resistance of corrosion and superiormechnical strength.

Ref. No Co.Cr	Lengths (mm)		
	A	B	C
ROT-422270-05	24	27	5
ROT-422270-10	24	27	10
ROT-422270-14	24	27	14

Blount Staples

Blount-klammern

Agrafes droites renforcees

Indication: Staples are used for tarsal arthrodesis, epiphysiodesis osteosynthesis.

Material: The blount staple is manufactured from casting Cr.Co-alloy according to ASTM F.75 - ISO

5832/4. This alloy characterized by demonstrating excellent biocompatibility together with a high resistance of corrosion and superiormechnical strength.

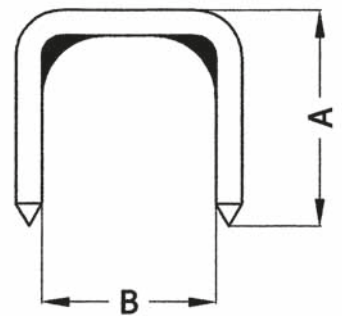

Ref. No Co. Cr	Lengths (mm)	
	A	B
ROT-423021-16	21	16
ROT-423021-22	21	22
ROT-423021-28	21	28

Coventry Staples

Stufenklammern

Agrafes en escalier

Indication: Used for fixation after tibial osteotomy.

Material: Certified Stainless Steel according to ASTM F.138 - ISO 5832/1.

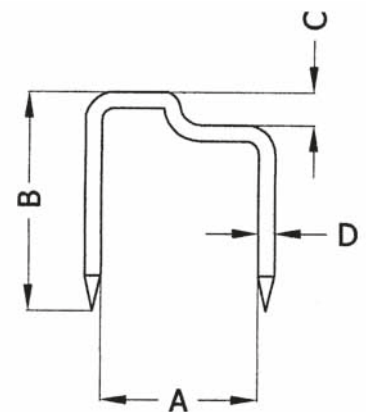

Ref. No	Lengths (mm)			
	A	B	C	D
ROT-423033-05	25	33	5	2.5
ROT-423033-10	25	33	10	2.5
ROT-423033-15	25	33	15	2.5



Epiphyseal Staples

Epiphysealklammern

Agrafes Epiphysaire

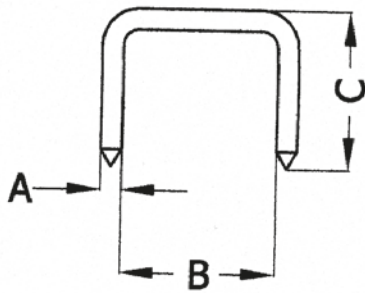

Indication: Staples are used for the temporary arrest of growth in order to correct a deformity of inequality of length. It is recommended that two or more staples be used on each size of epiphysis. Straight lateral incisions are used for a single epiphysis and slightly curved incisions for exposing both tibial and femoral epiphysis. The periosteum is freed sufficiently so that it may be retracted anteriorly for the introduction of one staple and posteriorly for the second staples.

Material: Certified Stainless Steel according to ASTM F.138 - ISO 5832/1.

Ref. No	Lengths (mm)		
	A	B	C
ROT-424015-16	1.5	16	19
ROT-424015-22	1.5	22	19
ROT-424015-26	1.5	26	19
ROT-424020-16	2.0	16	19
ROT-424020-22	2.0	22	19
ROT-424020-26	2.0	26	19
ROT-424025-16	2.5	16	19
ROT-424025-22	2.5	22	19
ROT-424025-26	2.5	26	19

Basisinstrumentensatz für Schrauben und Platten Basic instrument set for screws and plates	ROT S/2 + S/3
Stahlschrauben Set Steel screw set	ROT S/4 + S/5
Titanschrauben Set Titanium screw set	ROT S/6 + S/7
Großfragment-Kompressionsplatten, breit und schmal Broad and narrow compression plates set	ROT S/8 + S/9
Großfragment-Kompressionsplatten, breit und schmal, Titan Broad and narrow compression plates set, titanium	ROT S/10 + S/11
Kleinfragment Instrument- und Implantate-Set Small fragment instrument and steel implant set	ROT S/12 + S/13
Kleinfragment Instrument- und Implantate-Set, Titan Small fragment instrument and steel implant set, titanium	ROT S/14 + S/15
Mini Instrument- und Implantate-Set Mini instrument and steel implant set	ROT S/16 + S/17
Mini Instrument- und Implantate-Set, Titan Mini instrument and steel implant set, titanium	ROT S/18 + S/19
Instrumentensatz für DHS/DCS Schrauben und Platten Standard instrument set for dynamic and condylar screws and plates	ROT S/20 + S/21
Instrumentensatz für DHS Schrauben und Platten Dynamic hip screw standard implant set	ROT 2/22 + S/23
Instrumentensatz für DCS Schrauben und Platten Dynamic condylar standard implant set	ROT 2/24 + S/25
Küntscher Instrumente-Set Küntscher instrument set	ROT S/26 + S/27
Flexibles Ender Nagel Set Implant set for intramedullary guiding nails	ROT S/28 + S/29

Set / 3400001 Basic Instrument Set for Screws and Plates
(Steel Plates in Mat. DIN ISO 5832-1)



R 663.41
Tray for Basic Instrument Set
(Steel)

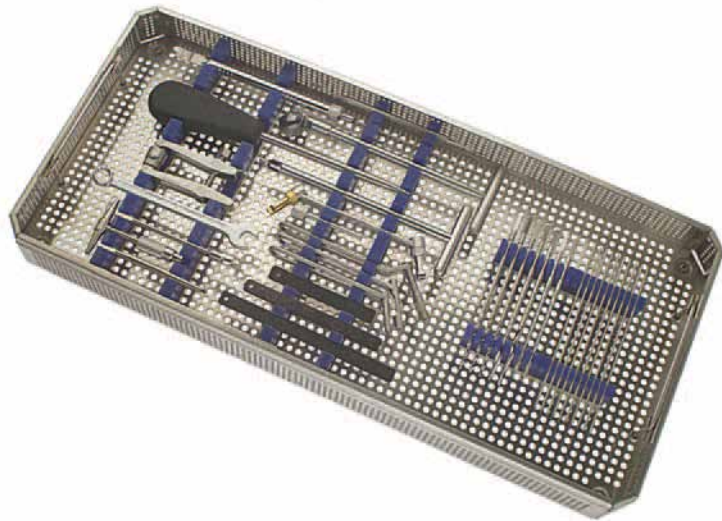

R 110.10
Sterilization Container
(recommended)

Set / 3400001 Basic Instrument Set for Screws and Plates
(Steel Plates in Mat. DIN ISO 5832-1)

		pcs.
34322-32	Drill bit with quick action connector 3,2 mm Ø, 145 mm long	3
34322-45	drill bit, Ø 4,5 mm, length 145 mm	2
34806-32	Malleolar countersink for malleolar screws, Ø 3,2 mm, length 12 cm	1
34296-25	T-handle for tap, 8,5 cm	1
34330-45	Taps with AO attachment, Ø 4,5 mm, length 13 cm	2
34330-65	Taps, Ø 6,5 mm, length 20 cm	1
34825-35	Soft-tissue sleeve for drill bit Ø 3,2 mm	1
34827-45	Drill bit sleeve for drill bit Ø 3,2 mm	1
34825-45	Soft-tissue sleeve, Ø 4,5 mm	1
34628-35	Screwdriver with handle artificial hexagonal, Ø 3,5 mm, length 20 cm	1
34635-35	Screwdriver bit, hexagonal, Ø 3,5 mm	1
34850-10	Depth gauge for large screws, 4,5 - 6,5 mm Ø, up to 100 mm	1
19219-15	sharp hook length 15 cm	1
34826-40	Drill bit sleeve for round-hole and semitubular plates, for drill bit, Ø 3,2 mm, stand. length 40 mm	1
34864-20	Plattenspanner, Spannweg 20 mm	1
34634-40	Cardan wrench 11 mm, length 18,5 cm	1
34516-11	Screw nut wrench 11 mm	1
34830-45	Drill bit guide, neutral and excentric for drill bit Ø 3,2 mm	1
34835-05	Bending templates 5-holes f. plates large fragments 4,5	1
34835-07	Bending templates 7-holes f plates Large fragment	1
34835-09	Bending templates 9-holes f plates Large fragment	1
34805-45	Countersink for malleolar screws, Ø 4,5 mm, length 18 cm	1
ROT-440150-20/T	drill wire, KIRSCHNER 15 cm trocar point/trocar, D. 2,0 mm	1
R 110.10	Container perforated lid, unperforated bottom 580x280x100 mm, silver	1
R 663.41	tray for instruments to screws a. plates	1

Set / 3400002 Steel Screw Set
(Steel Screws in Mat. DIN ISO 5832-1)



R 663.37
Tray for Screw Set



R 310.13
Sterilization Container
(recommended)

Cortex Screw Large Fragment			Head 8,0 mm Ø		
4,5 mm Ø			Hexagonal socket 3,5mm		
		pcs.			pcs.
ROT-108-014	screw length 14 mm	6	ROT-108-038	screw length 38 mm	7
ROT-108-016	screw length 16 mm	6	ROT-108-040	screw length 40 mm	14
ROT-108-018	screw length 18 mm	6	ROT-108-042	screw length 42 mm	6
ROT-108-020	screw length 20 mm	6	ROT-108-044	screw length 44 mm	6
ROT-108-022	screw length 22 mm	6	ROT-108-046	screw length 46 mm	6
ROT-108-024	screw length 24 mm	6	ROT-108-048	screw length 48 mm	3
ROT-108-026	screw length 26 mm	7	ROT-108-052	screw length 52 mm	3
ROT-108-028	screw length 28 mm	7	ROT-108-056	screw length 56 mm	3
ROT-108-030	screw length 30 mm	14	ROT-108-060	screw length 60 mm	3
ROT-108-032	screw length 32 mm	14	ROT-108-064	screw length 64 mm	3
ROT-108-034	screw length 34 mm	14	ROT-108-070	screw length 70 mm	3
ROT-108-036	screw length 36 mm	14			
Malleolar Screw 4,5 mm Ø			Head 8,0 mm Ø		
Large Fragm.			Hexagonal socket 3,5mm		
ROT-111-025	25 mm long, thread length 12 mm	3	ROT-111-050	50 mm long, thread length 24 mm	3
ROT-111-030	30 mm long, thread length 15 mm	3	ROT-111-055	55 mm long, thread length 26 mm	3
ROT-111-035	35 mm long, thread length 18 mm	3	ROT-111-060	60 mm long, thread length 28 mm	3
ROT-111-040	40 mm long, thread length 20 mm	3	ROT-111-065	65 mm long, thread length 30 mm	3
ROT-111-045	45 mm long, thread length 22 mm	3	ROT-111-070	70 mm long, thread length 32 mm	3
Cancellous screw 6,5 mm Ø			Head 8,0 mm Ø		
Large Fragm., 16 mm thread			Hexagonal socket 3,5 mm, 32 mm thread		
ROT-121-030	30 mm long, thread 16 mm	2	ROT-122-045	45 mm long, thread 32 mm	3
ROT-121-035	35 mm long, thread 16 mm	2	ROT-122-050	50 mm long, thread 32 mm	3
ROT-121-040	40 mm long, thread 16 mm	2	ROT-122-055	55 mm long, thread 32 mm	3
ROT-121-045	45 mm long, thread 16 mm	2	ROT-122-060	60 mm long, thread 32 mm	3
ROT-121-050	50 mm long, thread 16 mm	2	ROT-122-065	65 mm long, thread 32 mm	3
ROT-121-055	55 mm long, thread 16 mm	2	ROT-122-070	70 mm long, thread 32 mm	3
ROT-121-060	60 mm long, thread 16 mm	2	ROT-122-075	75 mm long, thread 32 mm	3
ROT-121-065	65 mm long, thread 16 mm	2	ROT-122-080	80 mm long, thread 32 mm	3
ROT-121-070	70 mm long, thread 16 mm	2	ROT-122-085	85 mm long, thread 32 mm	3
ROT-121-075	75 mm long, thread 16 mm	2	ROT-122-090	90 mm long, thread 32 mm	3
ROT-121-080	80 mm long, thread 16 mm	2	ROT-122-095	95 mm long, thread 32 mm	3
ROT-121-085	85 mm long, thread 16 mm	2	ROT-122-100	100 mm long, thread 32 mm	3
ROT-121-090	90 mm long, thread 16 mm	2	ROT-122-105	105 mm long, thread 32 mm	3
ROT-121-095	95 mm long, thread 16 mm	2	ROT-122-110	110 mm long, thread 32 mm	3
ROT-121-100	100 mm long, thread 16 mm	2			
ROT-121-105	105 mm long, thread 16 mm	2			
ROT-121-110	110 mm long, thread 16 mm	2			
full thread			full thread		
ROT-123-025	25 mm long, full thread	4	ROT-123-070	70 mm long, full thread	2
ROT-123-030	30 mm long, full thread	4	ROT-123-075	75 mm long, full thread	2
ROT-123-035	35 mm long, full thread	4	ROT-123-080	80 mm long, full thread	2
ROT-123-040	40 mm long, full thread	4	ROT-123-085	85 mm long, full thread	2
ROT-123-045	45 mm long, full thread	2	ROT-123-090	90 mm long, full thread	2
ROT-123-050	50 mm long, full thread	2	ROT-123-095	95 mm long, full thread	2
ROT-123-055	55 mm long, full thread	2	ROT-123-100	100 mm long, full thread	2
ROT-123-060	60 mm long, full thread	2	ROT-123-105	105 mm long, full thread	2
ROT-123-065	65 mm long, full thread	2	ROT-123-110	110 mm long, full thread	2
ROT-199-130	washer 13 mm Ø for screws 4,5 mm, 6,5 mm, 7,0 mm, 7,3 mm Ø, stainless steel, 1,5 mm strong				6
34701-01	Screw forceps				1
R 310.13	Container 1/2-size, perforated lid, unperforated bottom, 285x280x135 mm silver				1
R 663.37	tray for screws				1

Set / 3400002 T Titanium Screw Set
(Titanium Screws in Mat. DIN ISO 5832-3)



R 663.37
Tray for Screw Set



R 310.13
Sterilization Container
(recommended)

Cortex Screw		pcs.	Head 8,0 mm Ø		pcs.
Titanium Large Fragment 4,5 mm Ø			Hexagonal socket 3,5 mm		
ROT-108-014 T	screw length 14 mm	6	ROT-108-038 T	screw length 38 mm	7
ROT-108-016 T	screw length 16 mm	6	ROT-108-040 T	screw length 40 mm	14
ROT-108-018 T	screw length 18 mm	6	ROT-108-042 T	screw length 42 mm	6
ROT-108-020 T	screw length 20 mm	6	ROT-108-044 T	screw length 44 mm	6
ROT-108-022 T	screw length 22 mm	6	ROT-108-046 T	screw length 46 mm	6
ROT-108-024 T	screw length 24 mm	6	ROT-108-048 T	screw length 48 mm	3
ROT-108-026 T	screw length 26 mm	7	ROT-108-052 T	screw length 52 mm	3
ROT-108-028 T	screw length 28 mm	7	ROT-108-056 T	screw length 56 mm	3
ROT-108-030 T	screw length 30 mm	14	ROT-108-060 T	screw length 60 mm	3
ROT-108-032 T	screw length 32 mm	14	ROT-108-066 T	screw length 64 mm	3
ROT-108-034 T	screw length 34 mm	14	ROT-108-070 T	screw length 70 mm	3
ROT-108-036 T	screw length 36 mm	14			
Malleolar Screw			Head 8,0 mm Ø		
Titanium 4,5 mm Ø, Large Fragment			Hexagonal socket 3,5 mm		
ROT-111-025 T	25 mm long, thread length 12 mm	3	ROT-111-050 T	50 mm long, thread length 24 mm	3
ROT-111-030 T	30 mm long, thread length 15 mm	3	ROT-111-055 T	55 mm long, thread length 26 mm	3
ROT-111-035 T	35 mm long, thread length 18 mm	3	ROT-111-060 T	60 mm long, thread length 28 mm	3
ROT-111-040 T	40 mm long, thread length 20 mm	3	ROT-111-065 T	65 mm long, thread length 30 mm	3
ROT-111-045 T	45 mm long, thread length 22 mm	3	ROT-111-070 T	70 mm long, thread length 32 mm	3
Cancellous screw Titanium 6,5 mm Ø			Head 8,0 mm Ø		
Large Fragment, 16 mm thread			Hexagonal socket 3,5 mm, 32 mm thread		
ROT-121-030 T	30 mm long, thread 16 mm	2	ROT-122-045 T	45 mm long, thread 32 mm	3
ROT-121-035 T	35 mm long, thread 16 mm	2	ROT-122-050 T	50 mm long, thread 32 mm	3
ROT-121-040 T	40 mm long, thread 16 mm	2	ROT-122-055 T	55 mm long, thread 32 mm	3
ROT-121-045 T	45 mm long, thread 16 mm	2	ROT-122-060 T	60 mm long, thread 32 mm	3
ROT-121-050 T	50 mm long, thread 16 mm	2	ROT-122-065 T	65 mm long, thread 32 mm	3
ROT-121-055 T	55 mm long, thread 16 mm	2	ROT-122-070 T	70 mm long, thread 32 mm	3
ROT-121-060 T	60 mm long, thread 16 mm	2	ROT-122-075 T	75 mm long, thread 32 mm	3
ROT-121-065 T	65 mm long, thread 16 mm	2	ROT-122-080 T	80 mm long, thread 32 mm	3
ROT-121-070 T	70 mm long, thread 16 mm	2	ROT-122-085 T	85 mm long, thread 32 mm	3
ROT-121-075 T	75 mm long, thread 16 mm	2	ROT-122-090 T	90 mm long, thread 32 mm	3
ROT-121-080 T	80 mm long, thread 16 mm	2	ROT-122-095 T	95 mm long, thread 32 mm	3
ROT-121-085 T	85 mm long, thread 16 mm	2	ROT-122-100 T	100 mm long, thread 32 mm	3
ROT-121-090 T	90 mm long, thread 16 mm	2	ROT-122-105 T	105 mm long, thread 32 mm	3
ROT-121-095 T	95 mm long, thread 16 mm	2	ROT-122-110 T	110 mm long, thread 32 mm	3
ROT-121-100 T	100 mm long, thread 16 mm	2			
ROT-121-105 T	105 mm long, thread 16 mm	2			
ROT-121-110 T	110 mm long, thread 16 mm	2			
full thread			full thread		
ROT-123-025 T	25 mm long, full thread	4	ROT-123-070 T	70 mm long, full thread	2
ROT-123-030 T	30 mm long, full thread	4	ROT-123-075 T	75 mm long, full thread	2
ROT-123-035 T	35 mm long, full thread	4	ROT-123-080 T	80 mm long, full thread	2
ROT-123-040 T	40 mm long, full thread	4	ROT-123-085 T	85 mm long, full thread	2
ROT-123-045 T	45 mm long, full thread	2	ROT-123-090 T	90 mm long, full thread	2
ROT-123-050 T	50 mm long, full thread	2	ROT-123-095 T	95 mm long, full thread	2
ROT-123-055 T	55 mm long, full thread	2	ROT-123-100 T	100 mm long, full thread	2
ROT-123-060 T	60 mm long, full thread	2	ROT-123-105 T	105 mm long, full thread	2
ROT-123-065 T	65 mm long, full thread	2	ROT-123-110 T	110 mm long, full thread	2
ROT-199-130 T	washer 13 mm Ø for screws 4,5 mm, 6,5 mm, 7,0 mm, 7,3 mm Ø, titanium 1,5 mm strong				6
34701-01	Screw forceps				1
R 310.13	Container 1/2-size, perforated lid, unperforated bottom, 285x280x135 mm silver				1
R 663.37	tray for screws				1

Set / 3400006 Broad and Narrow Plates Set
(Steel Plates in Mat. DIN ISO 5832-1)

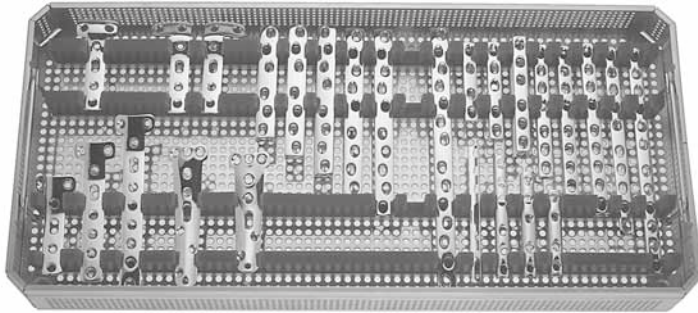

R 663.31
Tray for Broad and Narrow Plates Set



R 110.10
Sterilization Container
(recommended)

Set / 3400006 Broad and Narrow Plates Set
(Steel Plates in Mat. DIN ISO 5832-1)

		pcs.
ROT-210071-04 D	Semi-tubular plate for screws Ø 4.5 mm 4 holes, length 71 mm	2
ROT-210087-05 D	Semi-tubular plate for screws Ø 4.5 mm 5 holes, length 87 mm	2
ROT-210103-06 D	Semi-tubular plate for screws Ø 4.5 mm 6 holes, length 103 mm	2
ROT-210119-07 D	Semi-tubular plate for screws Ø 4.5 mm 7 holes, length 119 mm	1
ROT-207071-04 D	Compression plate, small 4 holes, length 71 mm	2
ROT-207087-05 D	Compression plate, small 5 holes, length 87 mm	2
ROT-207103-06 D	Compression plate, small 6 holes, length 103 mm	4
ROT-207119-07 D	Compression plate, small 7 holes, length 119 mm	2
ROT-207135-08 D	Compression plate, small 8 holes, length 135 mm	2
ROT-207151-09 D	Compression plate, small 9 holes, length 151 mm	2
ROT-207167-10 D	Compression plate, small 10 holes, length 167 mm	1
ROT-207199-12 D	Compression plate, small 12 holes, length 199 mm	1
ROT-206103-06 D	Compression plate, broad 6 holes, length 103 mm	2
ROT-206119-07 D	Compression plate, broad 7 holes, length 119 mm	2
ROT-206135-08 D	Compression plate, broad 8 holes, length 135 mm	2
ROT-206151-09 D	Compression plate, broad 9 holes, length 151 mm	1
ROT-206167-10 D	Compression plate, broad 10 holes, length 167 mm	1
ROT-206199-12 D	Compression plate, broad 12 holes, length 199 mm	1
ROT-206231-14 D	Compression plate, broad 14 holes, length 231 mm	1
ROT-225100-05	Spoon plate for screws Ø 4.5 mm, 5 holes, length 100 mm	1
ROT-225120-06	Spoon plate for screws Ø 4.5 mm, 6 holes, length 120 mm	1
ROT-226084-04	T-Plate for screws Ø 4.5 mm 4 holes, length 84 mm	1
ROT-226116-06	T-Plate for screws Ø 4.5 mm 6 holes, length 116 mm	1
ROT-226148-08	T-Plate for screws Ø 4.5 mm 8 holes, length 148 mm	1
ROT-227082-04	T-Buttress plate for screws Ø 4.5 mm 4 holes, length 82 mm	1
ROT-229088-04 L	L - Buttress plate, left for screws Ø 4.5 mm 4 holes, length 88 mm	1
ROT-229088-04 R	L-Buttress plate, right for screws Ø 4.5 mm 4 holes, length 88 mm	1
R 110.13	Container perforated lid, unperforated bottom 580x280x135 mm, silver	1
R 663.31	Tray for bone plates	1

Set / 3400006 T Broad and Narrow Plates Set
(Titanium Plates in Mat. DIN ISO 5832-3)

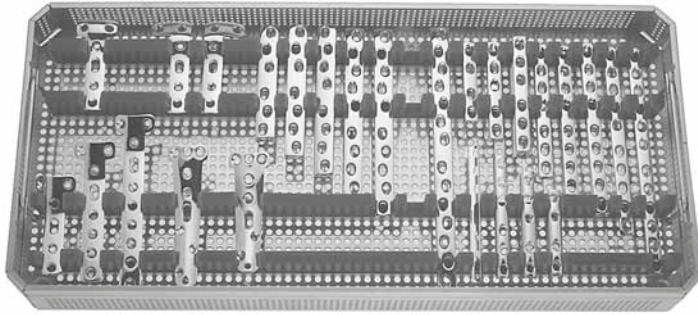

R 663.31
Tray for Broad and Narrow Plates Set



R 110.10
Sterilization Container
(recommended)

Set / 3400006 T Broad and Narrow Plates Set
(Titanium Plates in Mat. DIN ISO 5832-3)

		pcs.
ROT-210071-04 DT	Semi-tubular plate for screws Ø 4.5 mm 4 holes, length 71 mm	2
ROT-210087-05 DT	Semi-tubular plate for screws Ø 4.5 mm 5 holes, length 87 mm	2
ROT-210103-06 DT	Semi-tubular plate for screws Ø 4.5 mm 6 holes, length 103 mm	2
ROT-210119-07 DT	Semi-tubular plate for screws Ø 4.5 mm 7 holes, length 119 mm	1
ROT-207071-04 DT	Compression plate, small 4 holes, length 71 mm	2
ROT-207087-05 DT	Compression plate, small 5 holes, length 87 mm	2
ROT-207103-06 DT	Compression plate, small 6 holes, length 103 mm	4
ROT-207119-07 DT	Compression plate, small 7 holes, length 119 mm	2
ROT-207135-08 DT	Compression plate, small 8 holes, length 135 mm	2
ROT-207151-09 DT	Compression plate, small 9 holes, length 151 mm	2
ROT-207167-10 DT	Compression plate, small 10 holes, length 167 mm	1
ROT-207199-12 DT	Compression plate, small 12 holes, length 199 mm	1
ROT-206103-06 DT	Compression plate, broad 6 holes, length 103 mm	2
ROT-206119-07 DT	Compression plate, broad 7 holes, length 119 mm	2
ROT-206135-08 DT	Compression plate, broad 8 holes, length 135 mm	2
ROT-206151-09 DT	Compression plate, broad 9 holes, length 151 mm	1
ROT-206167-10 DT	Compression plate, broad 10 holes, length 167 mm	1
ROT-206199-12 DT	Compression plate, broad 12 holes, length 199 mm	1
ROT-206231-14 DT	Compression plate, broad 14 holes, length 231 mm	1
ROT-225100-05 T	Spoon plate for screws Ø 4.5 mm, 5 holes, length 100 mm	1
ROT-225120-06 T	Spoon plate for screws Ø 4.5 mm, 6 holes, length 120 mm	1
ROT-226084-04 T	T-Plate for screws Ø 4.5 mm 4 holes, length 84 mm	1
ROT-226116-06 T	T-Plate for screws Ø 4.5 mm 6 holes, length 116 mm	1
ROT-226148-08 T	T-Plate for screws Ø 4.5 mm 8 holes, length 148 mm	1
ROT-227082-04 T	T-Buttress plate for screws Ø 4.5 mm 4 holes, length 82 mm	1
ROT-229088-04 LT	L - Buttress plate, left for screws Ø 4.5 mm 4 holes, length 88 mm	1
ROT-229088-04 RT	L-Buttress plate, right for screws Ø 4.5 mm 4 holes, length 88 mm	1
R 110.13	Container perforated lid, unperforated bottom 580x280x135 mm, silver	1
R 663.31	Tray for bone plates	1

Set / 3400011 Small Fragment Instrument and Steel Implant Set
(Steel Screws and Plates in Mat. DIN ISO 5832-1)

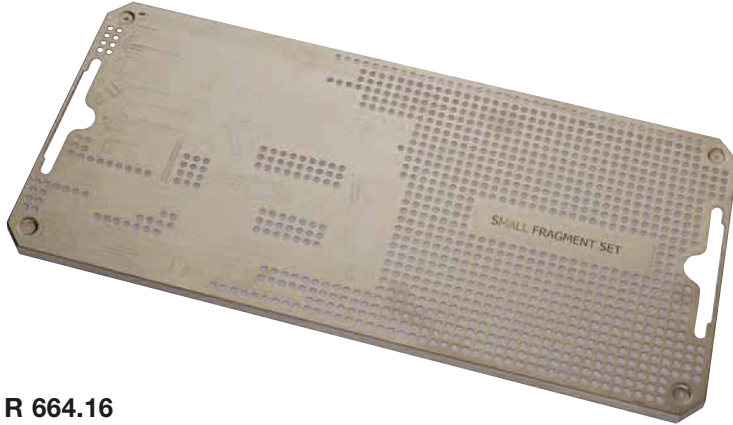

R 664.16
Tray for Small Fragment Instrument
and Steel Implant Set

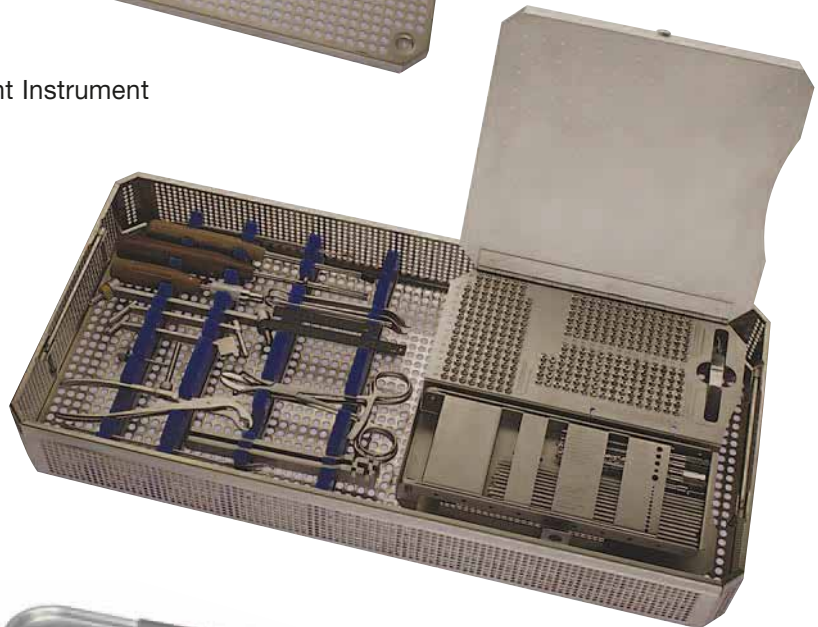

R 110.13
Sterilization Container
(recommended)

					pcs.
34322-25	drill bit m.Schnellkuppl.-ansatz, D. 2,5 mm, 110 mm				2
34322-35	Drill bit with quick action connector 3,5 mm Ø, 100 mm long				2
34806-20	Countersink with AO Shaft 2,0 mm tip				1
34330-35/125	tap w. with AO attachment f. screws 3,5 mm Ø, thread pitch 1,25 mm				2
34330-40	Taps with AO attachment Ø 4,0 mm, length 13 cm 1,75 mm pitch				2
34296-35	Handle for AO attachment, 11 cm				1
34823-20	Parallel drill guide and drill sleeve for drill bit Ø 2,0 mm				1
34824-35	Soft-tissue sleeve and drill bit guide for drill bit Ø 2,5 mm / tap Ø 3,5 mm / cortical screws Ø 3,5 mm				1
34827-35	Insert Drill sleeve 3,5 mm / 2,7 mm				1
34628-25	Screwdriver with artificial handle hexagonal, Ø 2,5 mm, length 20 cm				1
34630-25	Screw holding sleeve f. 2,5 mm hexagonal screws				1
34635-25	Screw driver bits for hexagonal socket 2,5 mm, quick coupling for handles #34296-25 / #34296-30 / #34296-35				1
34850-05	Depth gauge for small screws 2,7 - 4,0 mm Ø, up to 50 mm				1
34830-35	Drill bit guide for neutral and eccentric holes, for drill bit Ø 2,5 mm and for cortical screws Ø 3,5 mm				1
19219-15	sharp hook length 15 cm				1
34641-02	Bending iron for small plates 2,7 mm and 3,5 mm, length 14 cm				1
34641-01	Bending iron for small plates 2,7 mm and 3,7 mm, length 14 cm				1
34836-07	Bending templates 7-holes f plates Mini fragment				1
34836-09	Bending templates 9-holes f plates Mini fragment 3,5				1
33391-15	bone holding forceps selfcentering with thread fixation, 15 cm long				1
33409-13	bone holding forceps, REDA 13,5 cm				1
33413-14	REDA bone holding forceps, self-centering, length 135 mm				1
33811-06	bone lever, HOHMANN-MINI 16 cm, 6 mm				1
33811-08	bone lever, HOHMANN-MINI 16 cm, 8 mm				1
33813-12	bone lever, 14 mm, 12 cm				2
33740-19	periosteal elevator with ferre 19 cm, 6 mm				1
34701-01	Screw forceps				1
	Cortex Screw Small Fragment, 3,5 mm Ø	pcs	Head 6,0 mm Ø, Hexagonal socket 2,5mm		pcs.
ROT-104-010	screw length 10 mm	8	ROT-104-026	screw length 26 mm	8
ROT-104-012	screw length 12 mm	8	ROT-104-028	screw length 28 mm	8
ROT-104-014	screw length 14 mm	8	ROT-104-032	screw length 32 mm	8
ROT-104-016	screw length 16 mm	8	ROT-104-036	screw length 36 mm	8
ROT-104-018	screw length 18 mm	8	ROT-104-040	screw length 40 mm	8
ROT-104-020	screw length 20 mm	8	ROT-104-045	screw length 45 mm	8
ROT-104-022	screw length 22 mm	8	ROT-104-050	screw length 50 mm	8
ROT-104-024	screw length 24 mm	8			
	Cancellous screw 4,0 mm Ø, Small Fragm.,	pcs.	Head 6,0 mm Ø, Hexagonal socket 2,5mm		pcs.
ROT-106-014	screw length 14 mm, full thread	6	ROT-107-012	screw length 12 mm, short thread	6
ROT-106-016	screw length 16 mm, full thread	6	ROT-107-014	screw length 14 mm, short thread	6
ROT-106-018	screw length 18 mm, full thread	6	ROT-107-016	screw length 16 mm, short thread	6
ROT-106-020	screw length 20 mm, full thread	6	ROT-107-018	screw length 18 mm, short thread	6
ROT-106-022	screw length 22 mm, full thread	6	ROT-107-020	screw length 20 mm, short thread	6
ROT-106-024	screw length 24 mm, full thread	6	ROT-107-022	screw length 22 mm, short thread	6
ROT-106-026	screw length 26 mm, full thread	6	ROT-107-024	screw length 24 mm, short thread	6
ROT-106-028	screw length 28 mm, full thread	6	ROT-107-026	screw length 26 mm, short thread	6
ROT-106-032	screw length 32 mm, full thread	6	ROT-107-028	screw length 28 mm, short thread	6
ROT-106-035	screw length 35 mm, full thread	6	ROT-107-030	screw length 32 mm, short thread	6
ROT-106-040	screw length 40 mm, full thread	6	ROT-107-035	screw length 35 mm, short thread	6
ROT-106-045	screw length 45 mm, full thread	6	ROT-107-040	screw length 40 mm, short thread	6
ROT-106-050	screw length 50 mm, full thread	6	ROT-107-045	screw length 45 mm, short thread	6
ROT-106-055	screw length 55 mm, full thread	4	ROT-107-050	screw length 50 mm, short thread	6
ROT-106-060	screw length 60 mm, full thread	4			
ROT-199-070	washer for screw 7 mm Ø 2,7mm, 3,5 mm und 4,0 mm Ø not for cannulated screw 4,0 mm Ø				6
	Plates for screws 3,5mm				
ROT-233050-03 3	T-Plate straight, small 3 holes (shank), length 50 mm	1	ROT-211025-02 D	One-third tubular plate 2 holes, length 25 mm	1
ROT-233056-04 4	T-Plate straight, small 4 holes (shank), length 56 mm	1	ROT-211037-03 D	One-third tubular plate 3 holes, length 37 mm	1
ROT-232052-03	T-Plate, oblique-angled 3 holes (shank), length 52 mm	1	ROT-211049-04 D	One-third tubular plate 4 holes, length 49 mm	1
ROT-232072-05	T-Plate, oblique-angled 5 holes (shank), length 72 mm	1	ROT-211062-05 D	One-third tubular plate 5 holes, length 62 mm	1
			ROT-211073-06 D	One-third tubular plate 6 holes, length 73 mm	1
ROT-230088-03	Cloverleaf plate, 3 holes, length 88 mm	1	ROT-211085-07 D	One-third tubular plate 7 holes, length 85 mm	1
ROT-230104-04	Cloverleaf-plate, 4 holes, length 104 mm	1	ROT-211097-08 D	One-third tubular plate 8 holes, length 97 mm	1
ROT-209074-06 D	small fragment plate, 6 holes, length 73 mm	2		drill wire, KIRSCHNER 15 cm	
ROT-209086-07 D	small fragment plate, 7 holes, length 85 mm	2	ROT-440150-12/T	trocar point/trocar, D. 1,2 mm	12
ROT-209098-08 D	small fragment plate, 8 holes, length 97 mm	2	ROT-440150-16/T	trocar point/trocar, D. 1,6 mm	12
ROT-209110-09 D	small fragment plate, 9 holes, length 109 mm	2	ROT-440150-20/T	trocar point/trocar, D. 2,0 mm	12
R 110.13	Container perforated lid, unperforated bottom 580x280x135 mm, silver				1
R 664.16	Tray for small fragment instruments, screws and plates				1

Set / 3400011 T Small Fragment Instrument and Titanium Implant Set
(Titanium Screws and Plates in Mat. DIN ISO 5832-3)

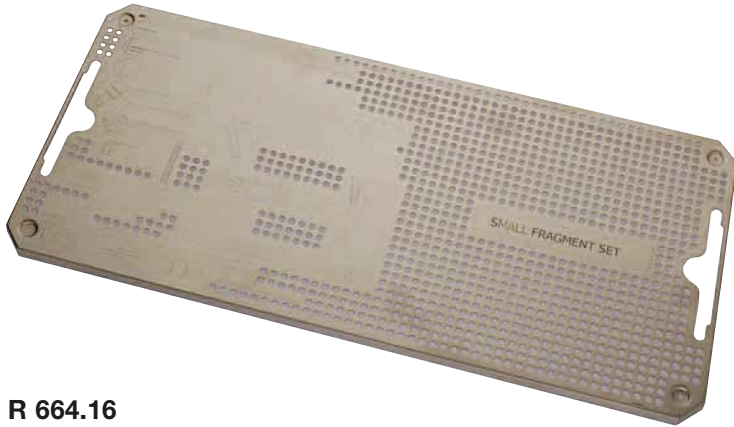

R 664.16
Tray for Small Fragment Instrument
and Titanium Implant Set

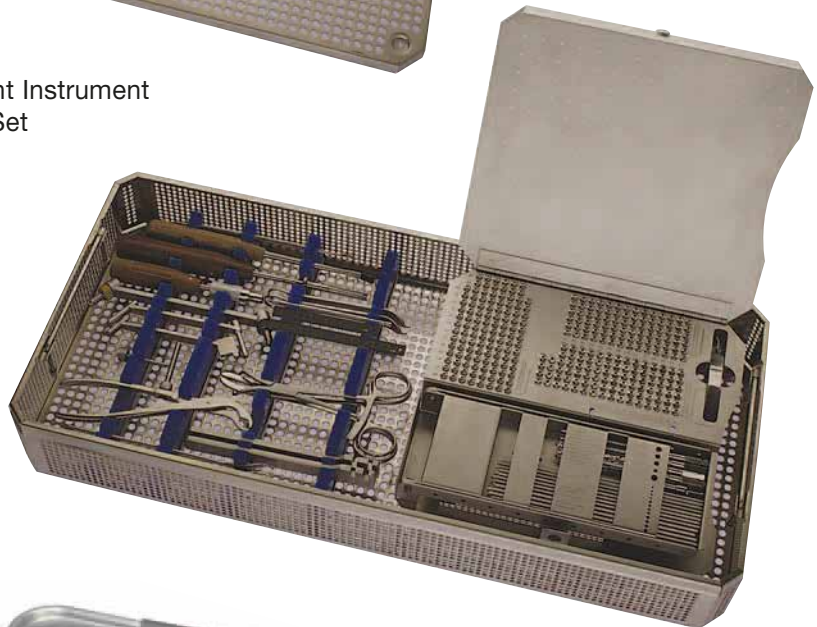

R 110.13
Sterilization Container
(recommended)

					pcs.
34322-25	drill bit m.Schnellkuppl.-ansatz, D. 2,5 mm, 110 mm				2
34322-35	Drill bit with quick action connector 3,5 mm Ø, 100 mm long				2
34806-20	Countersink with AO Shaft 2,0 mm tip				1
34330-35/125	tap w. with AO attachment f. screws 3,5 mm Ø, thread pitch 1,25 mm				2
34330-40	Taps with AO attachment Ø 4,0 mm, length 13 cm 1,75 mm pitch				2
34296-35	Handle for AO attachment, 11 cm				1
34823-20	Parallel drill guide and drill sleeve for drill bit Ø 2,0 mm				1
34824-35	Soft-tissue sleeve and drill bit guide for drill bit Ø 2,5 mm / tap Ø 3,5 mm / cortical screws Ø 3,5 mm				1
34827-35	Insert Drill sleeve 3,5 mm / 2,7 mm				1
34628-25	Screwdriver with artificial handle hexagonal, Ø 2,5 mm, length 20 cm				1
34630-25	Screw holding sleeve f. 2,5 mm hexagonal screws				1
34635-25	Screw driver bits for hexagonal socket 2,5 mm, quick coupling for handles #34296-25 / #34296-30 / #34296-35				1
34850-05	Depth gauge for small screws 2,7 - 4,0 mm Ø, up to 50 mm				1
34830-35	Drill bit guide for neutral and eccentric holes, for drill bit Ø 2,5 mm and for cortical screws Ø 3,5 mm				1
19219-15	sharp hook length 15 cm				1
34641-02	Bending iron for small plates 2,7 mm and 3,5 mm, length 14 cm				1
34641-01	Bending iron for small plates 2,7 mm and 3,7 mm, length 14 cm				1
34836-07	Bending templates 7-holes f plates Mini fragment				1
34836-09	Bending templates 9-holes f plates Mini fragment 3,5				1
33391-15	bone holding forceps selfcentering with thread fixation, 15 cm long				1
33409-13	bone holding forceps, REDA 13,5 cm				1
33413-14	REDA bone holding forceps, self-centering, length 135 mm				1
33811-06	bone lever, HOHMANN-MINI 16 cm, 6 mm				1
33811-08	bone lever, HOHMANN-MINI 16 cm, 8 mm				1
33813-12	bone lever, 14 mm, 12 cm				2
33740-19	periosteal elevator with ferre 19 cm, 6 mm				1
34701-01	Screw forceps				1
	Cortex Screw Small Fragment, 3,5 mm Ø	pcs	Head 6,0 mm Ø, Hexagonal socket 2,5mm		pcs.
ROT-104-010 T	screw length 10 mm	8	ROT-104-026 T	screw length 26 mm	8
ROT-104-012 T	screw length 12 mm	8	ROT-104-028 T	screw length 28 mm	8
ROT-104-014 T	screw length 14 mm	8	ROT-104-032 T	screw length 32 mm	8
ROT-104-016 T	screw length 16 mm	8	ROT-104-036 T	screw length 36 mm	8
ROT-104-018 T	screw length 18 mm	8	ROT-104-040 T	screw length 40 mm	8
ROT-104-020 T	screw length 20 mm	8	ROT-104-045 T	screw length 45 mm	8
ROT-104-022 T	screw length 22 mm	8	ROT-104-050 T	screw length 50 mm	8
ROT-104-024 T	screw length 24 mm	8			
	Cancellous screw 4,0 mm Ø, Small Fragm.,	pcs.	Head 6,0 mm Ø, Hexagonal socket 2,5mm		pcs.
ROT-106-014 T	screw length 14 mm, full thread	6	ROT-107-012 T	screw length 12 mm, short thread	6
ROT-106-016 T	screw length 16 mm, full thread	6	ROT-107-014 T	screw length 14 mm, short thread	6
ROT-106-018 T	screw length 18 mm, full thread	6	ROT-107-016 T	screw length 16 mm, short thread	6
ROT-106-020 T	screw length 20 mm, full thread	6	ROT-107-018 T	screw length 18 mm, short thread	6
ROT-106-022 T	screw length 22 mm, full thread	6	ROT-107-020 T	screw length 20 mm, short thread	6
ROT-106-024 T	screw length 24 mm, full thread	6	ROT-107-022 T	screw length 22 mm, short thread	6
ROT-106-026 T	screw length 26 mm, full thread	6	ROT-107-024 T	screw length 24 mm, short thread	6
ROT-106-028 T	screw length 28 mm, full thread	6	ROT-107-026 T	screw length 26 mm, short thread	6
ROT-106-032 T	screw length 32 mm, full thread	6	ROT-107-028 T	screw length 28 mm, short thread	6
ROT-106-035 T	screw length 35 mm, full thread	6	ROT-107-030 T	screw length 32 mm, short thread	6
ROT-106-040 T	screw length 40 mm, full thread	6	ROT-107-035 T	screw length 35 mm, short thread	6
ROT-106-045 T	screw length 45 mm, full thread	6	ROT-107-040 T	screw length 40 mm, short thread	6
ROT-106-050 T	screw length 50 mm, full thread	6	ROT-107-045 T	screw length 45 mm, short thread	6
ROT-106-055 T	screw length 55 mm, full thread	4	ROT-107-050 T	screw length 50 mm, short thread	6
ROT-106-060 T	screw length 60 mm, full thread	4			
ROT-199-070 T	washer for screw 7 mm Ø 2,7 mm, 3,5 mm und 4,0 mm Ø not for cannulated screw 4,0 mm Ø				6
	Plates for screws 3,5mm				
ROT-233050-03 3 T	T-Plate straight, small 3 holes (shank), length 50 mm	1	ROT-211025-02 DT	One-third tubular plate 2 holes, length 25 mm	1
ROT-233056-04 4 T	T-Plate straight, small 4 holes (shank), length 56 mm	1	ROT-211037-03 DT	One-third tubular plate 3 holes, length 37 mm	1
ROT-232052-03 T	T-Plate, oblique-angled 3 holes (shank), length 52 mm	1	ROT-211049-04 DT	One-third tubular plate 4 holes, length 49 mm	1
ROT-232072-05 T	T-Plate, oblique-angled 5 holes (shank), length 72 mm	1	ROT-211062-05 DT	One-third tubular plate 5 holes, length 62 mm	1
			ROT-211073-06 DT	One-third tubular plate 6 holes, length 73 mm	1
ROT-230088-03 T	Cloverleaf plate, 3 holes, length 88 mm	1	ROT-211085-07 DT	One-third tubular plate 7 holes, length 85 mm	1
ROT-230104-04 T	Cloverleaf-plate, 4 holes, length 104 mm	1	ROT-211097-08 DT	One-third tubular plate 8 holes, length 97 mm	1
ROT-209074-06 DT	small fragment plate, 6 holes, length 73 mm	2		drill wire, KIRSCHNER 15 cm	
ROT-209086-07 DT	small fragment plate, 7 holes, length 85 mm	2	ROT-440150-12/T	trocar point/trocar, D. 1,2 mm	12
ROT-209098-08 DT	small fragment plate, 8 holes, length 97 mm	2	ROT-440150-16/T	trocar point/trocar, D. 1,6 mm	12
ROT-209110-09 DT	small fragment plate, 9 holes, length 109 mm	2	ROT-440150-20/T	trocar point/trocar, D. 2,0 mm	12
R 110.13	Container perforated lid, unperforated bottom 580x280x135 mm, silver				1
R 664.16	Tray for small fragment instruments, screws and plates				1

Set / 3400021 Mini Instrument and Steel Implant Set
(Steel Screws and Plates in Mat. DIN ISO 5832-1)

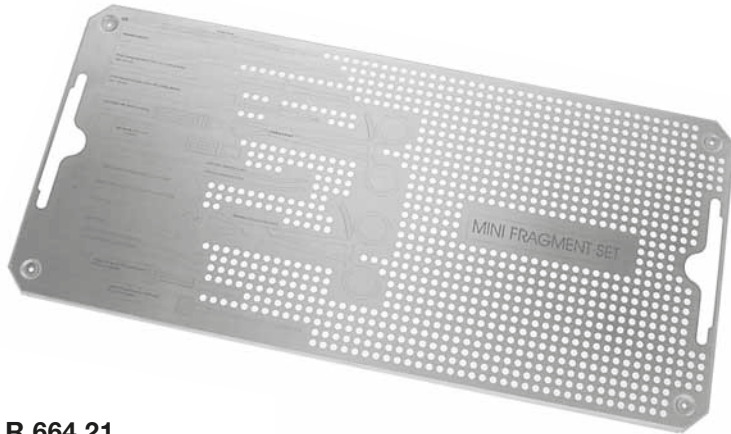

R 664.21
Tray for Mini Instrument and
Implant Set (Steel)



R 110.10
Sterilization Container
(recommended)

		pcs.
34322-20	drill bit w.quick coupling (AO) 2,0 mm Ø, 100 mm long	2
34322-27	Drill bit with quick action 2,7 mm Ø, 100 mm long	2
34806-20	Countersink with AO Shaft 2,0 mm tip	1
34330-27	Gewindeschneider mit AO-Ansatz Ø 2,7 mm	2
34296-35	Handle for AO attachment, 11 cm	1
34823-20	Parallel drill guide and drill sleeve for drill bit Ø 2,0 mm	1
34825-35	Soft-tissue sleeve for drill bit Ø 3,2 mm	1
34628-25	Screwdriver with artificial handle hexagonal, Ø 2,5 mm, length 20 cm	1
34630-25	Screw holding sleeve f. 2,5 mm hexagonal screws	1
34850-05	Depth gauge for small screws 2,7 - 4,0 mm Ø, up to 50 mm	1
34322-11	drill bit m.Schnellkuppl.- ansatz, D. 1,1 mm, 60 mm	2
34322-15	drill bit m.Schnellkuppl.- ansatz, D. 1,5 mm, 85 mm	2
34806-11	Countersink with AO Shaft 1,1 mm tip	1
34330-15/38	Taps with dental attachment Ø 1,5 mm, length 38 mm	2
34330-20/38	Taps with dental attachment Ø 2,0 mm, length 38 mm	2
34296-40	Handle for dental attachment, 10,5 cm	1
34822-15	Tissue protection sleeve 127 mm, f.Drills a. tapes 1,5/1,1 mm	1
34850-03	Depth gauge for mini screws 1,5 - 2,0 mm Ø, up to 30 mm	1
19219-15	sharp hook length 15 cm	1
34628-15	screw driver w. ferrozell handle 1,5 mm hexagonal socket 20 cm long	1
34642-01	Bending iron for small plates 2,0 mm 2 mm/120 mm	1
33410-13	holding forceps for Mini,13,5 cm	1
33408-13	Reduction forceps with tips length 135 mm	1
33811-06	bone lever, HOHMANN-MINI 16 cm, 6 mm	1
33811-08	bone lever, HOHMANN-MINI 16 cm, 8 mm	1
33813-12	bone lever, 14 mm, 12 cm	2
33741-18	periosteal elevator with ferre 18,5 cm, 3 mm	1
34701-01	Screw forceps	1
ROT-103-006	Cortex Screw Small Fragment, 2,7 mm Ø, Head 5,0 mm Ø, screw length 6 mm, Hexagonal socket 2,5 mm	6
ROT-103-008	Cortex Screw Small Fragment, 2,7 mm Ø, Head 5,0 mm Ø, screw length 8 mm, Hexagonal socket 2,5 mm	6
ROT-103-010	Cortex Screw Small Fragment, 2,7 mm Ø, Head 5,0 mm Ø, screw length 10 mm, Hexagonal socket 2,5 mm	6
ROT-103-012	Cortex Screw Small Fragment, 2,7 mm Ø, Head 5,0 mm Ø, screw length 12 mm, Hexagonal socket 2,5 mm	6
ROT-103-014	Cortex Screw Small Fragment, 2,7 mm Ø, Head 5,0 mm Ø, screw length 14 mm, Hexagonal socket 2,5 mm	6
ROT-103-016	Cortex Screw Small Fragment, 2,7 mm Ø, Head 5,0 mm Ø, screw length 16 mm, Hexagonal socket 2,5 mm	6
ROT-103-018	Cortex Screw Small Fragment, 2,7 mm Ø, Head 5,0 mm Ø, screw length 18 mm, Hexagonal socket 2,5 mm	6
ROT-103-020	Cortex Screw Small Fragment, 2,7 mm Ø, Head 5,0 mm Ø, screw length 20 mm, Hexagonal socket 2,5 mm	6
ROT-103-022	Cortex Screw Small Fragment, 2,7 mm Ø, Head 5,0 mm Ø, screw length 22 mm, Hexagonal socket 2,5 mm	6
ROT-103-024	Cortex Screw Small Fragment, 2,7 mm Ø, Head 5,0 mm Ø, screw length 24 mm, Hexagonal socket 2,5 mm	6
ROT-199-070	washer for screw 7 mm Ø, 2,7 mm, 3,5 mm und 4,0 mm Ø, not for cannulated screw 4,0 mm Ø	6
ROT-235023-03	Quarter-tubular platefor screws Ø 2,7 mm, 3 holes, length 23 mm	2
ROT-235031-04	Quarter-tubular platefor screws Ø 2,7 mm, 4 holes, length 31 mm	2
ROT-235039-05	Quarter-tubular platefor screws Ø 2,7 mm, 5 holes, length 39 mm	2
ROT-235047-06	Quarter-tubular platefor screws Ø 2,7 mm, 6 holes, length 47 mm	2
ROT-235055-07	Quarter-tubular platefor screws Ø 2,7 mm, 7 holes, length 55 mm	2
ROT-235063-08	Quarter-tubular platefor screws Ø 2,7 mm, 8 holes, length 63 mm	2
ROT-234034-03 L	L-Plate oblique, leftfor screws Ø 2,7 mm, 3 holes, length 34 mm	2
ROT-234034-03 R	L-Plate oblique, rightfor screws Ø 2,7 mm, 3 holes, length 34 mm	2
ROT-234032-03	T-platefor screws Ø 2,7 mm, 3 holes, length 32 mm	4
ROT-440100-08	drill wire, KIRSCHNER 10 cm, trocar point/round, D. 0,8 mm	10
ROT-440100-10	drill wire, KIRSCHNER 10 cm, trocar point/round, D. 1,0 mm	10
ROT-440150-10	drill wire, KIRSCHNER 15 cm, trocar point/round, D. 1,0 mm	10
ROT-440150-12/T	drill wire, KIRSCHNER 15 cm, trocar point/trocar, D. 1,2 mm	10
ROT-440150-16/T	drill wire, KIRSCHNER 15 cm, trocar point/trocar, D. 1,6 mm	10
ROT-101-006	Cortex Screw Mini Fragment, 1,5 mm Ø, Head 3,0 mm Ø, screw length 6 mm, Hexagonal socket 1,5 mm	4
ROT-101-007	Cortex Screw Mini Fragment, 1,5 mm Ø, Head 3,0 mm Ø, screw length 7 mm, Hexagonal socket 1,5 mm	4
ROT-101-008	Cortex Screw Mini Fragment, 1,5 mm Ø, Head 3,0 mm Ø, screw length 8 mm, Hexagonal socket 1,5 mm	4
ROT-101-009	Cortex Screw Mini Fragment, 1,5 mm Ø, Head 3,0 mm Ø, screw length 9 mm, Hexagonal socket 1,5 mm	4
ROT-101-010	Cortex Screw Mini Fragment, 1,5 mm Ø, Head 3,0 mm Ø, screw length 10 mm, Hexagonal socket 1,5 mm	4
ROT-101-011	Cortex Screw Mini Fragment, 1,5 mm Ø, Head 3,0 mm Ø, screw length 11 mm, Hexagonal socket 1,5 mm	4
ROT-101-012	Cortex Screw Mini Fragment, 1,5 mm Ø, Head 3,0 mm Ø, screw length 12 mm, Hexagonal socket 1,5 mm	4
ROT-101-014	Cortex Screw Mini Fragment, 1,5 mm Ø, Head 3,0 mm Ø, screw length 14 mm, Hexagonal socket 1,5 mm	4
ROT-101-016	Cortex Screw Mini Fragment, 1,5 mm Ø, Head 3,0 mm Ø, screw length 16 mm, Hexagonal socket 1,5 mm	4
ROT-102-006	Cortex Screw Mini Fragment, 2,0 mm Ø, Head 4,0 mm, screw length 6 mm, Hexagonal socket 1,5 mm	6
ROT-102-008	screw corticalis mini D. 2 mm, length 8 mm	6
ROT-102-010	screw corticalis mini D. 2 mm, length 10 mm	6
ROT-102-012	screw corticalis mini D. 2 mm, length 12 mm	6
ROT-102-014	screw corticalis mini D. 2 mm, length 14 mm	6
ROT-102-016	screw corticalis mini D. 2 mm, length 16 mm	6
ROT-102-018	screw corticalis mini D. 2 mm, length 18 mm	6
ROT-102-020	screw corticalis mini D. 2 mm, length 20 mm	6
ROT-247017-03	Plate mini fragment for screws Ø 2,0 mm, 3 holes, length 17 mm	2
ROT-247023-04	Plate mini fragment for screws Ø 2,0 mm, 4 holes, length 23 mm	2
ROT-247029-05	Plate mini fragment for screws Ø 2,0 mm, 5 holes, length 29 mm	2
ROT-247019-02 L	L-Plate oblique, left for screws Ø 2,0 mm, 2 holes, length 19 mm	2
ROT-247019-02 R	L-Plate oblique, right for screws Ø 2,0 mm, 2 holes, length 19 mm	2
ROT-247018-02	T-Plate, for screws Ø 2,0 mm, 2 holes, length 18 mm	4
R 110.10	Container perforated lid, unperforated bottom 580x280x100 mm, silver	1
R 664.21	Tray for MINI instrumenation set, screws and plates	1

Set / 3400021 T Mini Instrument / Titanium Implant Set
(Titanium Screws and Plates in Mat. DIN ISO 5832-3)

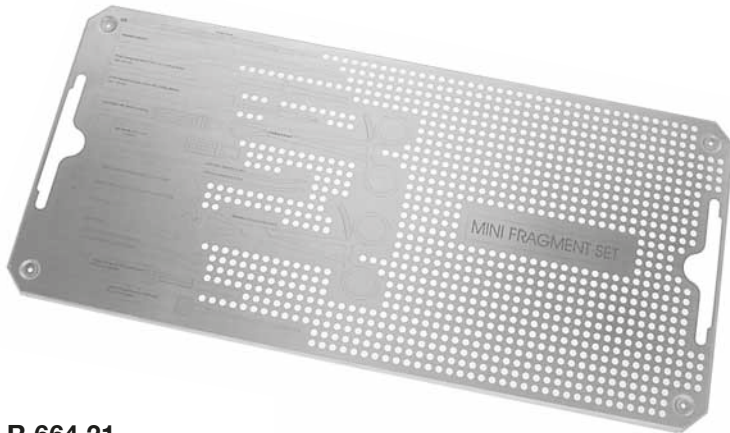

R 664.21
Tray for Mini Instrument and
Implant Set (Steel)



R 110.10
Sterilization Container
(recommended)

		pcs.
34322-20	drill bit w.quick coupling (AO) 2,0 mm Ø, 100 mm long	2
34322-27	Drill bit with quick action 2,7 mm Ø, 100 mm long	2
34806-20	Countersink with AO Shaft 2,0 mm tip	1
34330-27	Gewindeschneider mit AO-Ansatz Ø 2,7 mm	2
34296-35	Handle for AO attachment, 11 cm	1
34823-20	Parallel drill guide and drill sleeve for drill bit Ø 2,0 mm	1
34825-35	Soft-tissue sleeve for drill bit Ø 3,2 mm	1
34628-25	Screwdriver with artificial handle hexagonal, Ø 2,5 mm, length 20 cm	1
34630-25	Screw holding sleeve f. 2,5 mm hexagonal screws	1
34850-05	Depth gauge for small screws 2,7 - 4,0 mm Ø, up to 50 mm	1
34322-11	drill bit m.Schnellkuppl.- ansatz, D. 1,1 mm, 60 mm	2
34322-15	drill bit m.Schnellkuppl.- ansatz, D. 1,5 mm, 85 mm	2
34806-11	Countersink with AO Shaft 1,1 mm tip	1
34330-15/38	Taps with dental attachment Ø 1,5 mm, length 38 mm	2
34330-20/38	Taps with dental attachment Ø 2,0 mm, length 38 mm	2
34296-40	Handle for dental attachment, 10,5 cm	1
34822-15	Tissue protection sleeve 127 mm, f.Drills a. tapes 1,5/1,1 mm	1
34850-03	Depth gauge for mini screws 1,5 - 2,0 mm Ø, up to 30 mm	1
19219-15	sharp hook length 15 cm	1
34628-15	screw driver w. ferrozell handle 1,5 mm hexagonal socket 20 cm long	1
34642-01	Bending iron for small plates 2,0 mm 2 mm/120 mm	1
33410-13	holding forceps for Mini,13,5 cm	1
33408-13	Reduction forceps with tips length 135 mm	1
33811-06	bone lever, HOHMANN-MINI 16 cm, 6 mm	1
33811-08	bone lever, HOHMANN-MINI 16 cm, 8 mm	1
33813-12	bone lever, 14 mm, 12 cm	2
33741-18	periosteal elevator with ferre 18,5 cm, 3 mm	1
34701-01	Screw forceps	1
ROT-103-006 T	Cortex Screw Small Fragment, 2,7 mm Ø, Head 5,0 mm Ø, screw length 6 mm, Hexagonal socket 2,5 mm	6
ROT-103-008 T	Cortex Screw Small Fragment, 2,7 mm Ø, Head 5,0 mm Ø, screw length 8 mm, Hexagonal socket 2,5 mm	6
ROT-103-010 T	Cortex Screw Small Fragment, 2,7 mm Ø, Head 5,0 mm Ø, screw length 10 mm, Hexagonal socket 2,5 mm	6
ROT-103-012 T	Cortex Screw Small Fragment, 2,7 mm Ø, Head 5,0 mm Ø, screw length 12 mm, Hexagonal socket 2,5 mm	6
ROT-103-014 T	Cortex Screw Small Fragment, 2,7 mm Ø, Head 5,0 mm Ø, screw length 14 mm, Hexagonal socket 2,5 mm	6
ROT-103-016 T	Cortex Screw Small Fragment, 2,7 mm Ø, Head 5,0 mm Ø, screw length 16 mm, Hexagonal socket 2,5 mm	6
ROT-103-018 T	Cortex Screw Small Fragment, 2,7 mm Ø, Head 5,0 mm Ø, screw length 18 mm, Hexagonal socket 2,5 mm	6
ROT-103-020 T	Cortex Screw Small Fragment, 2,7 mm Ø, Head 5,0 mm Ø, screw length 20 mm, Hexagonal socket 2,5 mm	6
ROT-103-022 T	Cortex Screw Small Fragment, 2,7 mm Ø, Head 5,0 mm Ø, screw length 22 mm, Hexagonal socket 2,5 mm	6
ROT-103-024 T	Cortex Screw Small Fragment, 2,7 mm Ø, Head 5,0 mm Ø, screw length 24 mm, Hexagonal socket 2,5 mm	6
ROT-199-070 T	washer for screw 7 mm Ø, 2,7 mm, 3,5 mm und 4,0 mm Ø, not for cannulated screw 4,0 mm Ø	6
ROT-235023-03 T	Quarter-tubular platefor screws Ø 2.7 mm, 3 holes, length 23 mm	2
ROT-235031-04 T	Quarter-tubular platefor screws Ø 2.7 mm, 4 holes, length 31 mm	2
ROT-235039-05 T	Quarter-tubular platefor screws Ø 2.7 mm, 5 holes, length 39 mm	2
ROT-235047-06 T	Quarter-tubular platefor screws Ø 2.7 mm, 6 holes, length 47 mm	2
ROT-235055-07 T	Quarter-tubular platefor screws Ø 2.7 mm, 7 holes, length 55 mm	2
ROT-235063-08 T	Quarter-tubular platefor screws Ø 2.7 mm, 8 holes, length 63 mm	2
ROT-234034-03 LT	L-Plate oblique, leftfor screws Ø 2.7 mm, 3 holes, length 34 mm	2
ROT-234034-03 RT	L-Plate oblique, rightfor screws Ø 2.7 mm, 3 holes, length 34 mm	2
ROT-234032-03 T	T-platefor screws Ø 2.7 mm, 3 holes, length 32 mm	4
ROT-440100-08	drill wire, KIRSCHNER 10 cm, trocar point/round, D. 0,8 mm	10
ROT-440100-10	drill wire, KIRSCHNER 10 cm, trocar point/round, D. 1,0 mm	10
ROT-440150-10	drill wire, KIRSCHNER 15 cm, trocar point/round, D. 1,0 mm	10
ROT-440150-12/T	drill wire, KIRSCHNER 15 cm, trocar point/trocar, D. 1,2 mm	10
ROT-440150-16/T	drill wire, KIRSCHNER 15 cm, trocar point/trocar, D. 1,6 mm	10
ROT-101-006 T	Cortex Screw Mini Fragment, 1,5 mm Ø, Head 3,0 mm Ø, screw length 6 mm, Hexagonal socket 1,5 mm	4
ROT-101-007 T	Cortex Screw Mini Fragment, 1,5 mm Ø, Head 3,0 mm Ø, screw length 7 mm, Hexagonal socket 1,5 mm	4
ROT-101-008 T	Cortex Screw Mini Fragment, 1,5 mm Ø, Head 3,0 mm Ø, screw length 8 mm, Hexagonal socket 1,5 mm	4
ROT-101-009 T	Cortex Screw Mini Fragment, 1,5 mm Ø, Head 3,0 mm Ø, screw length 9 mm, Hexagonal socket 1,5 mm	4
ROT-101-010 T	Cortex Screw Mini Fragment, 1,5 mm Ø, Head 3,0 mm Ø, screw length 10 mm, Hexagonal socket 1,5 mm	4
ROT-101-011 T	Cortex Screw Mini Fragment, 1,5 mm Ø, Head 3,0 mm Ø, screw length 11 mm, Hexagonal socket 1,5 mm	4
ROT-101-012 T	Cortex Screw Mini Fragment, 1,5 mm Ø, Head 3,0 mm Ø, screw length 12 mm, Hexagonal socket 1,5 mm	4
ROT-101-014 T	Cortex Screw Mini Fragment, 1,5 mm Ø, Head 3,0 mm Ø, screw length 14 mm, Hexagonal socket 1,5 mm	4
ROT-101-016 T	Cortex Screw Mini Fragment, 1,5 mm Ø, Head 3,0 mm Ø, screw length 16 mm, Hexagonal socket 1,5 mm	4
ROT-102-006 T	Cortex Screw Mini Fragment, 2,0 mm Ø, Head 4,0 mm, screw length 6 mm, Hexagonal socket 1,5 mm	6
ROT-102-008 T	screw corticalis mini D. 2 mm, length 8 mm	6
ROT-102-010 T	screw corticalis mini D. 2 mm, length 10 mm	6
ROT-102-012 T	screw corticalis mini D. 2 mm, length 12 mm	6
ROT-102-014 T	screw corticalis mini D. 2 mm, length 14 mm	6
ROT-102-016 T	screw corticalis mini D. 2 mm, length 16 mm	6
ROT-102-018 T	screw corticalis mini D. 2 mm, length 18 mm	6
ROT-102-020 T	screw corticalis mini D. 2 mm, length 20 mm	6
ROT-247017-03 T	Plate mini fragment for screws Ø 2.0 mm, 3 holes, length 17 mm	2
ROT-247023-04 T	Plate mini fragment for screws Ø 2.0 mm, 4 holes, length 23 mm	2
ROT-247029-05 T	Plate mini fragment for screws Ø 2.0 mm, 5 holes, length 29 mm	2
ROT-247019-02 LT	L-Plate oblique, left for screws Ø 2.0 mm, 2 holes, length 19 mm	2
ROT-247019-02 RT	L-Plate oblique, right for screws Ø 2.0 mm, 2 holes, length 19 mm	2
ROT-247018-02 T	T-Plate, for screws Ø 2.0 mm, 2 holes, length 18 mm	4
R 110.10	Container perforated lid, unperforated bottom 580x280x100 mm, silver	1
R 664.21	Tray for MINI instrumenation set, screws and plates	1

Set / 3400031 Standard Instrument Set for Dynamic and Condylar Screws and Plates

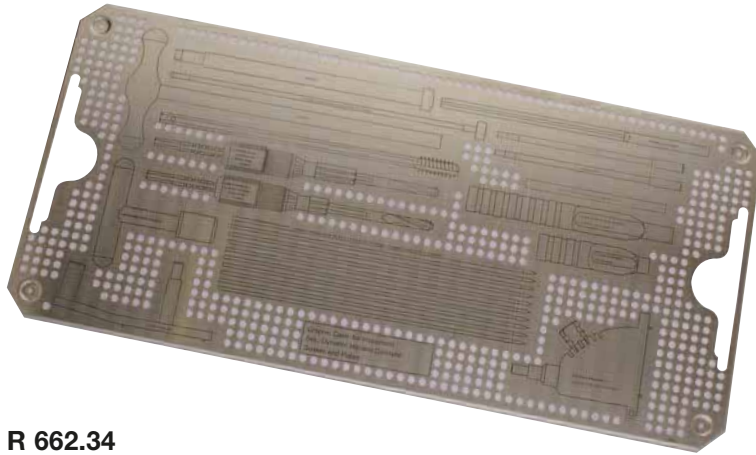

R 662.34
Tray for Instrument Set, Dynamic Hip
and Condylar Screws and Plates
(Steel)

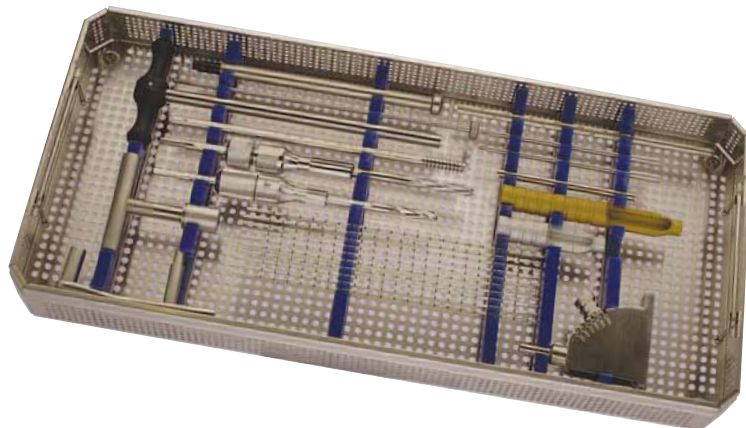

R 110.10
Sterilization Container
(recommended)

Set / 3400031 Standard Instrument Set for Dynamic and Condylar Screws and Plates

		pcs.
37092-23	guide wire, calibrated Ø 2,5 mm, length 230 mm	1
37093-00	Aiming device, 135°-150°	1
37092-00	Measuring sleeve, length 230 mm	1
37094-38	Combo reamer with 38 mm barrel length 21 cm	1
37096-42	extractor-wrench for hip screws	1
37096-43	Centering sleeve	1
37096-45	Centering sleeve, length 11 cm	1
37095-42	Guide shaft for insertion of coupling screws	1
37095-43	Lag screw inserter, length 21,5 cm	1
37095-41	Guide screw for insertion of coupling screws	1
37095-44	tap for compression hip screw	1
37095-40	Plate impactor, length 21 cm	1
37096-00	T-handle with coupling for 37093-00 and 37096-42	1
37057-00	Drill guide for condylar plates	1
37094-25	Combo reamer with 25 mm barrel length 21 cm, DCS plattes	1
R 110.10	Container perforated lid, unperforated bottom 580x280x100 mm, silver	1
R 662.34	tray for instruments to DHS	1

Set / 3400032 Dynamic Hip Screw Standard Implant Set
(Steel Plates in Mat. DIN ISO 5832-1)

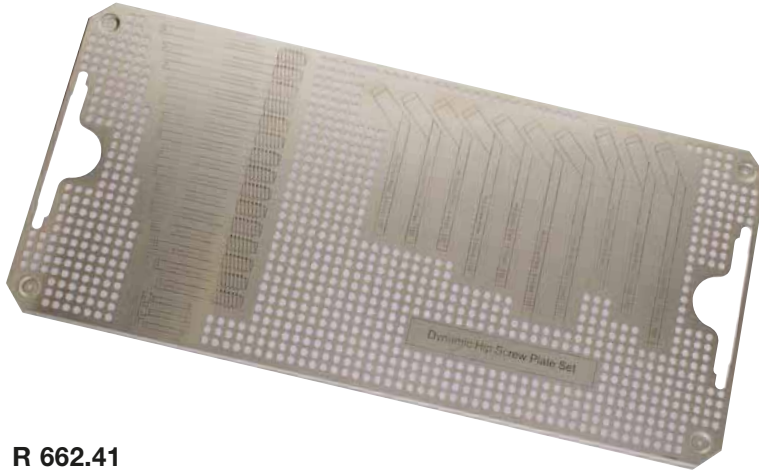

R 662.41
Tray for Dynamic Hip Screw
Standard Implant Set
(Steel)

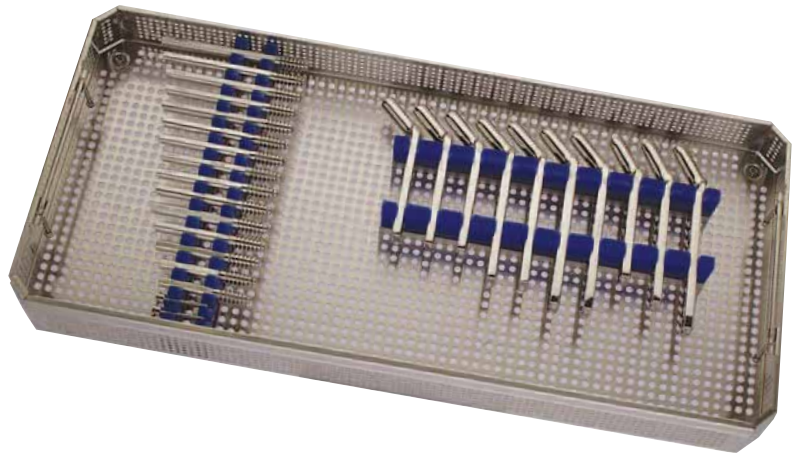

R 110.10
Sterilization Container
(recommended)

Set / 3400032 Dynamic Hip Screw Standard Implant Set
(Steel Plates in Mat. DIN ISO 5832-1)

		pcs.
ROT-312065	Dynamic Lag Screw, Thread Length 22 mm total length 65 mm	1
ROT-312070	Dynamic Lag Screw, Thread Length 22 mm total length 70 mm	1
ROT-312075	Dynamic Lag Screw, Thread Length 22 mm total length 75 mm	2
ROT-312080	Dynamic Lag Screw, Thread Length 22 mm total length 80 mm	2
ROT-312085	Dynamic Lag Screw, Thread Length 22 mm total length 85 mm	2
ROT-312090	Dynamic Lag Screw, Thread Length 22 mm total length 90 mm	2
ROT-312095	Dynamic Lag Screw, Thread Length 22 mm total length 95 mm	2
ROT-312100	Dynamic Lag Screw, Thread Length 22 mm total length 100 mm	2
ROT-312105	Dynamic Lag Screw, Thread Length 22 mm total length 105 mm	1
ROT-312110	Dynamic Lag Screw, Thread Length 22 mm total length 110 mm	1
ROT-312115	Dynamic Lag Screw, Thread Length 22 mm total length 115 mm	1
ROT-312031	Compression Screw, 36 mm	3
ROT-310135-04	Dynamic hip screw plate 135° 38 mm Barrel, 4 holes	3
ROT-310135-05	Dynamic hip screw plate 135° 38 mm Barrel, 5 holes	2
ROT-310135-06	Dynamic hip screw plate 135° 38 mm Barrel, 6 holes	2
ROT-310150-04	Dynamic hip screw plate 150° 38 mm Barrel, 4 holes	1
ROT-310150-05	Dynamic hip screw plate 150° 38 mm Barrel, 5 holes	1
ROT-310150-06	Dynamic hip screw plate 150° 38 mm Barrel, 6 holes	1
R 110.10	Container perforated lid, unperforated bottom 580x280x100 mm, silver	1
R 662.41	DHS implant tray	1

Set / 3400033 Dynamic Condylar Standard Implant Set
(Steel Plates in Mat. DIN ISO 5832-1)

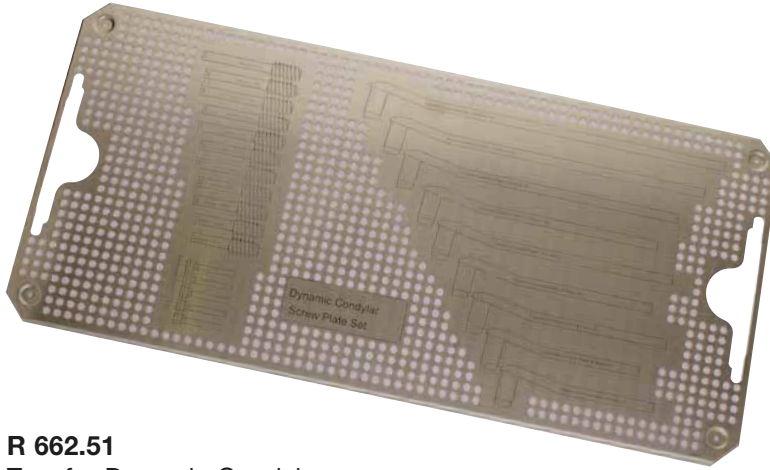

R 662.51
Tray for Dynamic Condylar
Standard Implant Set
(Steel)

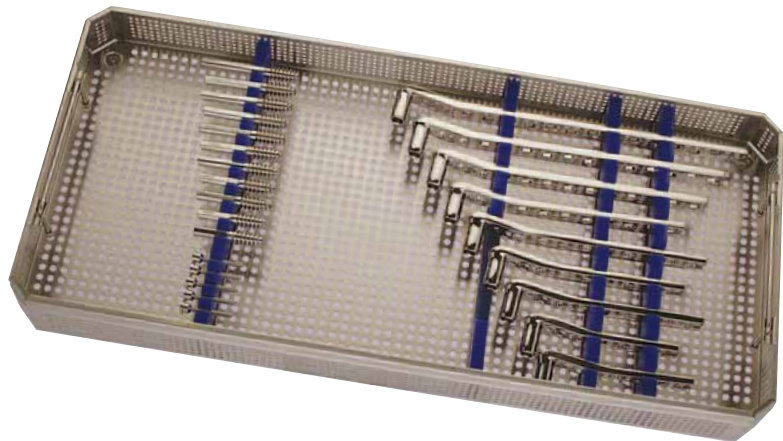

R 110.10
Sterilization Container
(recommended)

Set / 3400033 Dynamic Hip Screw Standard Implant Set
(Steel Plates in Mat. DIN ISO 5832-1)

		pcs.
ROT-312050	Dynamic Lag Screw, Thread length 22 mm length 50 mm	2
ROT-312055	Dynamic Lag Screw, Thread length 22 mm length 55 mm	2
ROT-312060	Dynamic Lag Screw, Thread length 22 mm length 60 mm	2
ROT-312065	Dynamic Lag Screw, Thread length 22 mm length 65 mm	2
ROT-312070	Dynamic Lag Screw, Thread length 22 mm length 70 mm	2
ROT-312075	Dynamic Lag Screw, Thread length 22 mm length 75 mm	1
ROT-312031	Compression Screw, 36mm	3
ROT-311114-06	Condylar bone-plate 95°, 6 holes, 114 mm long	2
ROT-311146-08	Condylar bone-plate 95°, 8 holes, 146 mm long	2
ROT-311178-10	Condylar bone-plate 95°, 10 holes, 178 mm long	2
ROT-311210-12	Condylar bone-plate 95°, 12 holes, 210 mm long	1
ROT-311242-14	Condylar bone-plate 95°, 14 holes, 242 mm long	1
ROT-311274-16	Condylar bone plate 95°, 16 holes, 274 mm long	1
R 110.10	Container perforated lid, unperforated bottom 580x280x100 mm, silver	1
R 662.51	DCS implant tray	1

Set / 3400051 Küntscher Instrumentation Set

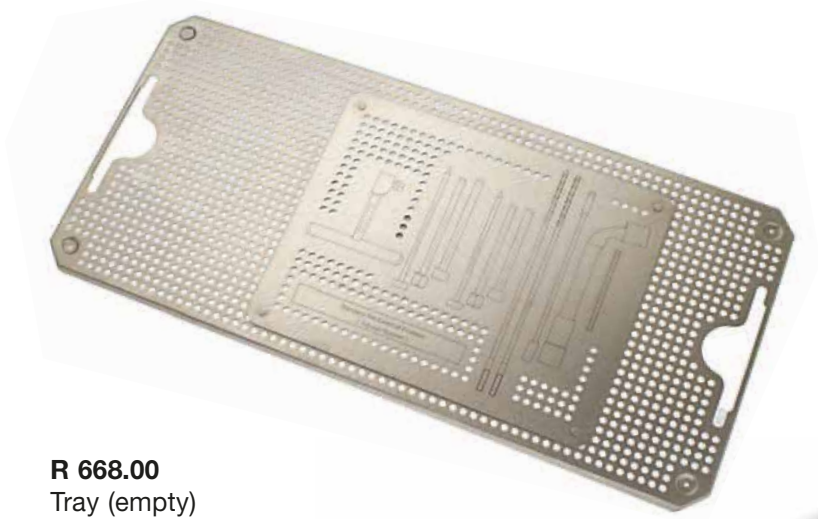

R 668.00
Tray (empty)



R 110.10
Sterilization Container
(recommended)

Set / 3400051 Küntscher Instrumentation Set

		pcs.
34570-02	reamer for medullary cave 26 cm, 10 mm	1
34573-35	reamer for femur, KUENTSCHER 35 cm	1
33700-11	Slotted hammer, width of the slot 14 mm	1
34589-01	Slotted nail driver f. KUENTSCHER nails	1
34588-01	nail impactor, KUENTSCHER 19 cm, for nails D.6-8 mm	1
34588-02	nail impactor, KUENTSCHER 19 cm, for nails D. 9-12 mm	1
34588-03	nail impactor, KUENTSCHER 19 cm, for nails D. 12-17 mm	1
34590-00	extractor w.2 hooks,KUENTSCHER 63 cm	1
37300-00	Measuring Device	1
33701-50	Hammer, w. hardpress handle 500 gr.	1
R 190.05	Tray for standard container 485x255x50 mm	1
R 110.10	Container perforated lid, unperforated bottom 580x280x100 mm, silver	1

Set / 3400052 Implant Set for Intramedullary Gliding Nails
(Steel and Titanium Gliding Nail Set)



R 665.00
Tray (empty)

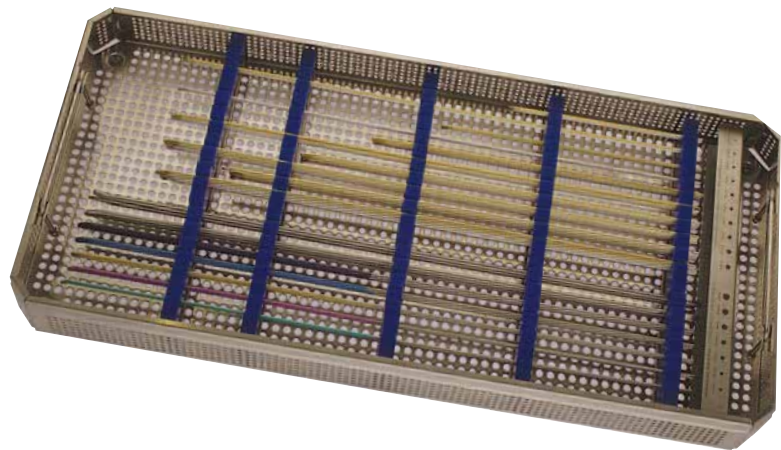

R 110.10
Sterilization Container
(recommended)

Set / 3400052 Implant Set for Intramedullary Gliding Nails
(Steel and Titanium Gliding Nail Set)

		pcs.
ROT-410045-30	flexible medullary nail, ENDER D. 4,5 mm 300 mm	3
ROT-410045-31	flexible medullary nail, ENDER D. 4,5 mm 310 mm	3
ROT-410045-32	flexible medullary nail, ENDER D. 4,5 mm 320 mm	3
ROT-410045-33	flexible medullary nail, ENDER D. 4,5 mm 330 mm	3
ROT-410045-34	flexible medullary nail, ENDER D. 4,5 mm 340 mm	3
ROT-410045-35	flexible medullary nail, ENDER D. 4,5 mm 350 mm	3
ROT-410045-36	flexible medullary nail, ENDER D. 4,5 mm 360 mm	3
ROT-410045-37	flexible medullary nail, ENDER D. 4,5 mm 370 mm	3
ROT-410045-38	flexible medullary nail, ENDER D. 4,5 mm 380 mm	3
ROT-410045-39	flexible medullary nail, ENDER D. 4,5 mm 390 mm	3
ROT-410045-40	flexible medullary nail, ENDER D. 4,5 mm 400 mm	3
ROT-410045-41	flexible medullary nail, ENDER D. 4,5 mm 410 mm	3
ROT-410045-42	flexible medullary nail, ENDER D. 4,5 mm 420 mm	3
ROT-410045-43	flexible medullary nail, ENDER D. 4,5 mm 430 mm	3
ROT-410045-44	flexible medullary nail, ENDER D. 4,5 mm 440 mm	3
ROT-410045-45	flexible medullary nail, ENDER D. 4,5 mm 450 mm	3
ROT-410045-46	flexible medullary nail, ENDER D. 4,5 mm 460 mm	3
ROT-410045-47	flexible medullary nail, ENDER D. 4,5 mm 470 mm	3
ROT-410045-48	flexible medullary nail, ENDER D. 4,5 mm 480 mm	3
ROT-410045-49	flexible medullary nail, ENDER D. 4,5 mm 490 mm	3
34612-00	nail inserter	1
34613-00	impactor	1
37305-24	bender, 24 cm	1
34617-00	impactor/extractor	1
34592-00	extractor medullary nails 63 cm	1
34570-01	reamer for medullary cave 26 cm, 8 mm	1
R 665.00	tray for gliding nails	1
R 110.10	Container perforated lid, unperforated bottom 580x280x100 mm, silver	1

Weitere Kataloge und Prospekte
Other cataloges and prospects

Hauptkatalog Chirurgische Instrumente
General catalog Surgical Instruments

Titan Instrumente
Titanium Instruments

Container Steriltechnik
Container Sterilization Technique

HERCULES Drahtkneifzange
HERCULES Wire Cutters

Neurochirurgie
Neuro Surgery

Laparoskopie
Laparoscopy

